



SLAMP®
THE LEADING LIGHT

∞
ENTANGLED LIGHT
COMPENDIUM 2023- 2024

poetic
passionate
fluid
ethical
lively
memorable
powerful
leading
unique
visionary
reliable
handmade

SLAMP:

ENTANGLED ∞ LIGHT

Nella storia dell'umanità ci sono momenti in cui anche un piccolo passo avanti tecnologico spalanca un mondo nuovo. Di solito queste innovazioni cambiano radicalmente il modo di vivere facendo apparire invecchiate le strade già tracciate.

La Luce fin dall'inizio dei tempi è stata momento di strappo tra una vecchia e una nuova Vita della nostra specie (dal fuoco alla lampadina arrivando ai fotoni o bio-fotoni). La Meraviglia di questo processo di continuo perfezionamento è che la scienza, nella maggior parte dei casi, coincide con quanto anticipato da civiltà molto molto antiche che probabilmente, con occhi diversi, riuscivano a "sentire" queste leggi universali.

Queste conoscenze del passato elevano a valore divino-creativo la luce e l'armonia come strumenti evolutivi imprescindibili per la nostra natura umana. Slamp ancora una volta vi racconta la sua storia, che risale sempre più verso il **punto di congiunzione tra la tecnica della Luce e l'armonia "Aurea"** delle forme per offrirvi oggetti unici e irripetibili.

Come la scienza ci insegna, **tutto è energia**, ma un corpo oltre ad emettere le proprie frequenze, viene, per così dire, investito da quelle emesse dagli altri corpi vicini e lontani.

Questo è possibile perché **viviamo in un sistema interconnesso di frequenze** in cui ogni essere è in correlazione con un altro fino a creare un'unica fittissima maglia energetica.

Questo fenomeno di interazione di forze è ciò che la scienza chiama **"entanglement quantistico"**, un concetto meglio noto con il nome di non-separabilità dei sistemi. **Anche se due oggetti sono separati, da pochi centimetri a migliaia di chilometri, ci sarà sempre un filo invisibile che li lega gli uni agli altri.** Il principio di entanglement dichiara: se due particelle vengono fatte interagire tra loro per un certo periodo di tempo e poi separate, quando si sollecita una delle due, istantaneamente si manifesta sulla seconda particella una analoga sollecitazione e questo succede a prescindere dalla distanza in cui si trovano.

Quando si sceglie di condividere il nostro tempo con una persona o si sceglie un oggetto per noi o il nostro spazio stiamo applicando questo principio che influenza nel tempo, sostanzialmente, il nostro percorso. Per questo dobbiamo **circondarci di bellezza**.

La lampada in particolare non è un oggetto passivo, ma una entità con la quale ci relazioniamo.

La sorgente di Luce interagisce con noi, con gli oggetti nello spazio e lo spazio stesso, modificando addirittura la percezione che abbiamo di esso. Luci e ombre, forme e colori, tutto concorre a generare "vibrazioni" che hanno capacità di dare origine a stati di gioia, pace e benessere.

L'equazione matematica usata dalla scienza per descrivere l'entanglement è chiamata "equazione dell'Amore" proprio per il suo principio di "intreccio vibrazionale" tra due soggetti.

Slamp parte dalla volontà di creare **oggetti luminosi che fanno innamorare del proprio ambiente** e regalano effetti che emozionano nel profondo. I nostri tecnopolimeri generano riflessioni e amplificazioni della Luce che riportano a mondi sconosciuti, oltre confini definiti e tali.

Volontà, Amore e Intelligenza sono i principi da cui parte ogni progetto, **frutto di un intreccio tra il cuore del designer e quello dell'azienda.** Quando accendete una Slamp, accendete questi stessi valori. In questa realtà, tutta Italiana, dove ogni giorno le sarte della Luce realizzano a mano le nostre lampade, l'Amore è per eccellenza l'energia più potente che conosciamo per creare "Entanglement" ossia legami indissolubili, tra l'essere umano e la Luce.

Throughout the history of humanity, small technological steps have created giant leaps towards a new reality. These innovations tend to radically change the way we live, casting aside previously travelled pathways as obsolete. Light has created the divide between our species' future and past Life since the beginning of time, shifting from fire, step by step, to photons and bio-photons.

This Wondrous process of continuous evolution exhibits how science in general coincides with what ancient civilizations surely interpreted, through a different lens, as "universal" laws. Knowledge of the past elevates the divine, creative value of light and harmony as evolutive instruments that transcend our own human nature.

Slamp is once more narrating the path that has guided them, a **continuous climb towards a joining of lighting technique and the harmonious "Aurea"** that defines each unique, unrepeatable object's shape. Science has taught us that everything harbors energy, and a body not only emits its own frequencies but absorbs, or rather, is inundated by those emitted from others both near and far.

This happens because we exist in an **interconnected system of frequencies** that bind one being to another in correlation that in the end, creates a tightly-woven, singular, energetic tapestry. The phenomenon of energetic interaction is scientifically named "quantum entanglement", better known as systems that cannot be separated. **Even when two objects are distant by mere centimeters or thousands of kilometers, they will always be connected by an invisible thread.**

Entanglement is the principle of involvement and then separation, where particles interact for a time, and then no longer do so. When one is activated, the second, regardless of distance, is individually activated as well.

When we spend time with another, or select an object for ourselves or our space, we've innately chosen this principle that over time, greatly influences our individual pathways.

This is why we must surround ourselves with beauty.

Lamps are "beings" that refuse to be passive, objects that we create and share relationships with. A light source interacts with us, our surrounding spaces, and the objects that inhabit within them, changing our perception of each.

Light and shadow, shapes and colors, all generating vibrations that serve as the genesis of peace, joy, and wellbeing. The mathematical term to describe entanglement is the "love equation" due to the vibrations that bind two subjects.

Slamp's desire is to create objects that make us fall in love with our spaces, evoking profound emotions. Our technopolymers create unexpected reflections that amplify Light's ability to travel beyond the confines that define our current, accepted reality, instead introducing new, unknown worlds.

Determination, Adoration, and Intelligence permeate every project, born of the shared soul that ties designers to our company. When you turn on a Slamp lamp, you ignite the company's values. Italian values, woven into products handcrafted by the feminine hands that tailor light every day. Each exudes a love for excellence, the unbreakable energy that shapes "Entanglement" between being and Light.

Luca Mazza
Slamp General Director

EDITOR

Roberto Ziliani

CREATIVE DIRECTION

Luca Mazza

MARKETING & COMMUNICATION

Erika Martino

VISUAL & GRAPHIC DESIGN

Noemi Patriarca

PHOTOS

Thomas Pagani

Ezio Gosti

Massimo Listri

Pedro Sadio

Lorenzo Sechi

Fabio Di Carlo

RENDERING

Chromatika Multimedia

PRE-PRINTED & PRINTED

Printed in March 2023

Euroteam

The Green Soul Printing

 This Catalogue has been printed using plant-based ink.
Questo Catalogo è stampato con inchiostri a base vegetale.



SLAMP S.p.A.

Via Vaccareccia 12/14

00071 - Pomezia, Roma, Italy

tel. +39 06 916 23 91 - fax +39 06 916 23 933

info@slamp.com - www.slamp.com

ALPHABETICAL INDEX

ACCORDÉON	166	HUGO ARCHITECTURAL	112
ACCORDÉON VERTICAL	170	HUGO VERTICAL	108
ARIA	32	IDEA	362
ARIA INFINITA	24	KALATOS	160
ATLANTE	234	LA BELLE ÉTOILE	126
ATMOSFERA	248	LA LOLLO	180
AURORA	316	LA LOLLONA	174
AVIA	44	LA TRAVIATA	70
AVIA EDITION	48	LA VIE	276
BACH	384	LAFLEUR	342
BIOS	314	LAS PALMAS	396
CACTUS	232	LE GRAND CEREMONY	218
CEREMONY	222	LILLIBET	224
CHANTAL	52	LIZA	244
CHARLOTTE	56	LUIS	240
CLIZIA	136	MEDUSA	246
CORDOBA	76	MIDA	290
DAFNE	318	MODULA	152
DIAMOND	390	MOON	366
DRUSA	230	NUVEM	94
ECSTACITY	510	ODEON	256
ÉTOILE	134	OVERLAY	372
FABULA	216	QUANTICA	120
FIGURELLA	242	SUPERMORGANA	236
FLORA	214	THE LIGHTNING ARCHIVES	488
GEMMY	250	TULIP	82
GINETTA	238	VELI	192
GOCCIA	226	VENTI	320
HALF CHARLOTTE	66	WOODY	228
HANAMI	210		
HUGO	106		

SUSPENSION LAMP INDEX



ACCORDÉON
p.166



ACCORDÉON VERTICAL
p.170



ARIA BLACK FADE
p.38



ARIA GOLD
p.32



ARIA INFINITA
p.24



HANAMI
p.210



HUGO
p.106



HUGO ARCHITECTURAL
p.112



HUGO VERTICAL
p.108



KALATOS
p.160



ARIA TRANSPARENT
p.36



ATLANTE
p.234



ATMOSFERA
p.248



AVIA
p.44



AVIA EDITION
p.48



LA BELLE ÉTOILE
p.126



LA LOLLO LINEAR
p.180



LA LOLLO
p.186



LA LOLLONA
p.174



LA TRAVIATA
p.70



CACTUS
p.232



CEREMONY
p.222



CHANTAL
p.52



CHARLOTTE GLOBE
p.56



CLIZIA
p.136



LE GRAND CEREMONY
p.218



LILLIBET
p.224



LIZA
p.244



LUIS
p.240



MEDUSA
p.246



CORDOBA
p.76



DRUSA
p.230



ÉTOILE
p.134



FABULA
p.216



FIGRELLA
p.242



MODULA
p.152

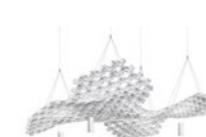

NUVEM
p.94



QUANTICA
p.120



SUPERMORGANA
p.236



TULIP
p.82



FLORA
p.214



GEMMY
p.250



GINETTA
p.238



GOCCIA
p.226



HALF-CHARLOTTE
p.66



VELI
p.196

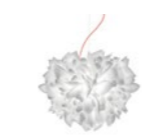

VELI FOLIAGE
p.192



VELI MINI
p.198



VELI 7
p.208



WOODY
p.228

SUSPENSION LAMP INDEX

CEILING LAMP INDEX



AURORA
p.316



BIOS
p.314



CLIZIA
p.262



DAFNE
p.318



DRUSA
p.282



ÉTOILE
p.310



FABULA
p.312



HANAMI
p.306



KALATOS
p.286



LA BELLE ÉTOILE
p.308



LA VIE
p.276



MIDA
p.290



ODEON
p.256



VELI
p.296



VELI FOLIAGE
p.294



VENTI
p.320

TABLE LAMP INDEX



ACCORDÉON
p.330



ACCORDÉON BATTERY
p.324



ATMOSFERA
p.386



BACH
p.384



CACTUS
p.388



CLIZIA BATTERY
p.348



CLIZIA
p.358



DIAMOND
p.390



FIORELLINA
p.380



GEMMY
p.392



IDEA
p.362



LAFLEUR
p.342



LAS PALMAS
p.396



LIZA
p.368



MOON
p.366



OVERLAY
p.372



TULIP
p.334



VELI
p.378



VELI FOLIAGE
p.376

WALL LAMP INDEX



ARIA
p.40



BIOS
p.460



CHARLOTTE
p.64



CLIZIA
p.404



CLIZIA APPLIQUE
p.408



DAFNE
p.462



DRUSA
p.458



ÉTOILE
p.454



FABULA
p.456



FIORELLA
p.464



HANAMI
p.450



IDEA
p.438



LA BELLE ÉTOILE
p.452



LA FLEUR
p.434



LA LOLLO
p.400



LA VIE
p.428



LILLIBET
p.470



MEDUSA
p.468



MIDA
p.444



MIDA APPLIQUE
p.448



VELI
p.420



VELI FOLIAGE
p.418



VENTI
p.466

FLOOR LAMP INDEX



ATLANTE
p.516



BACH
p.484



BIOS
p.504



CACTUS
p.496



CHARLOTTE
p.60



DAFNE
p.506



DIAMOND
p.512



ECSTACITY
p.510



FLORA
p.500



HUGO
p.492



LA LOLLO
p.480



LAS PALMAS
p.508



MODULA
p.474



THE LIGHTNING ARCHIVES
p.488



VENTI
p.514

SLAMP

THE LEADING LIGHT

unveil the unique

Every Slamp lamp is unique. Unique because it does not originate from a 3D file; the creative process requires a designer to get their hands dirty as they cut, "sew", and sculpt materials, applying years of concrete and studious research and development. Unique because the ladies who "tailor light" don their white gloves and proudly bring a poetically original piece to life. Unique because a lamp is the pure expression of the person who selected it, reflecting their aesthetic identity, those who leave light as the only vibration on a silent evening, unwittingly reigniting the energy of an artistic creation with a single click.

Ogni lampada Slamp è unica. Unica perché frutto di un processo creativo che non origina da un file 3d, ma che richiede al progettista la volontà di "sporcarsi le mani", tagliando, cucendo e trattando materiali e valori sedimentati in anni di studio, ricerca e innovazione. Unica perché allestita in un Atelier dove ogni giorno le Sarte della Luce, indossati i loro guanti bianchi, sono orgogliose di mettere al mondo un capo che si distingue per poetica e originalità. Unica perché espressione di chi ama raccontare la propria identità attraverso gli oggetti che lo circondano; di chi lascia che la silenziosa presenza della luce si trasformi nella migliore colonna sonora di una sera; di chi ogni giorno con un click sull'interruttore riaccende, inconsapevolmente, tutta l'energia della creazione.

beyond LIGHT

EVERY DAY, WITHIN OUR 8,000 SQ. M ATELIER JUST OUTSIDE OF ROME, WE BRING LIGHT BEYOND THE BOUNDARIES OF WHAT HAS ALREADY BEEN SEEN, BLENDING AESTHETICS AND ETHICS, CHOOSING UNIQUE MATERIALS AND SUSTAINABLE TECHNOLOGIES.

NEL NOSTRO ATELIER MANIFATTURIERO DI 8.000 MQ ALLE PORTE DI ROMA, OGNI GIORNO PORTIAMO LA LUCE OLTRE I CONFINI DEL GIÀ VISTO, FONDENDO ESTETICA ED ETICA, SCEGLIENDO MATERIALI UNICI E TECNOLOGIE SOSTENIBILI.



PLAY VIDEO

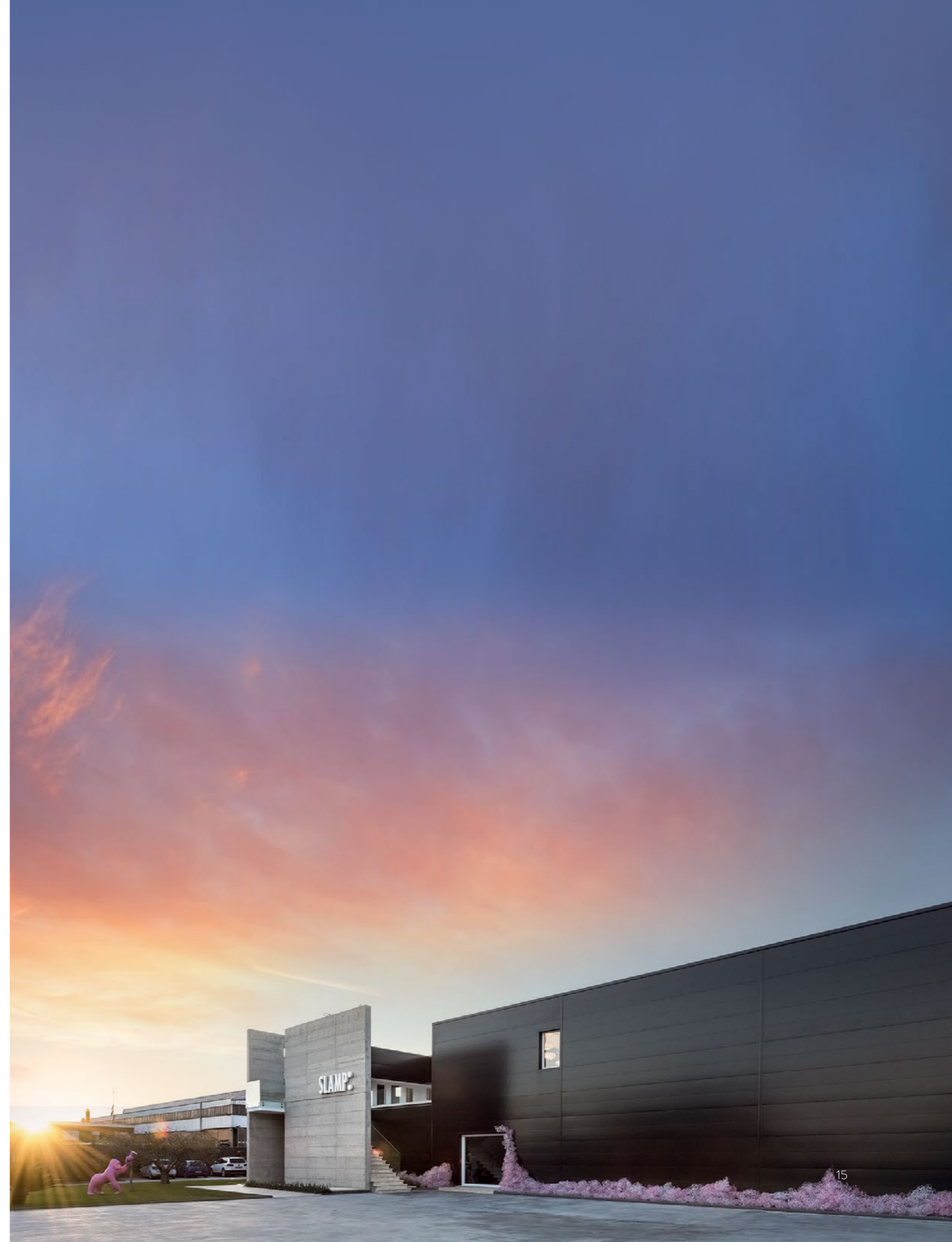



SAR
TO
RIAL
HANDCRAFTING

handmade

in Italy SINCE 1994

Slamp has been at the forefront of creating innovative, original, eclectic, and contemporary lamps since 1994, taking current inspiration from the natural world, architectural and sartorial genius, and artistic trends. Slamp creates suggestive, luminous, and versatile objects using the latest generation of materials, manually moulded into elements that combined together, make up a luxurious landscape. **The use of exclusive, lightweight and resistant technopolymers gives a unique and recognizable touch to every lamp, allowing it to be sculpted into three dimensional shapes, decorations and effects that would be impossible using any other material.** Much like any maison dedicated to haute couture, Slamp lamps undergo a precise ritual that transforms a sheet of technopolymer material into an exceptionally decorative, three dimensional shape through cold cutting and handcrafting.

Nel panorama dell'illuminazione decorativa di design, Slamp è punto di riferimento per chiunque desideri un oggetto ricercato, originale, esclusivo e innovativo. Catturando gli stimoli più attuali, attingendo al mondo naturale, ai virtuosismi architettonici e sartoriali, alle tendenze artistiche, dal 1994 Slamp crea oggetti luminosi, suggestivi e versatili grazie all'impiego di materiali di nuova generazione e a una speciale abilità manuale nell'assemblare elementi che si compongono dando vita a un lussureggiante panorama figurativo. **Unicità e riconoscibilità di ogni lampada passano attraverso l'uso di tecnopolimeri esclusivi, leggeri, nobili e infrangibili che permettono di realizzare forme, decori ed effetti altrimenti impossibili con altri materiali.** Come in una maison di haute couture, la creazione di una lampada Slamp passa attraverso una precisa ritualità che trasforma, tramite un sistema di lavorazioni a freddo, incastri e piegature eseguite a mano, un foglio piano di tecnopolimero in un volume tridimensionale altamente decorativo.



PLAY VIDEO

SUSTAINABLE AND RELIABLE

The quality of Slamp's materials and their sustainable approach to working with them has set the company apart since 1994. Their resistant, long-lasting technopolymers not only exhibit optimal thermal, electrical, and chemical properties, but these unique materials are recyclable. Trucost conducted a study for the American Chemistry Council and found that technopolymers help to reduce environmental cost by four times of those incurred by other materials. Environmental cost is calculated by comparing economic statistics and the sum of elements leading to climactic change, damage to seas and oceans, and damage to human beings. Slamp applied the same approach to their headquarters, inaugurated September 8, 2019. High priority was placed on architectural decisions, including isolating thermal materials and large windows facing the production lines to reduce the use of artificial light. The hub's energy comes from predominantly renewable sources.

Per le qualità intrinseche dei materiali che impiega, e per le tecniche di lavorazione che utilizza, Slamp è un'azienda a basso impatto ambientale sin dal 1994. I tecnopolimeri, resistenti e durevoli, sono dotati di ottime proprietà termiche, elettriche e chimiche, e – soprattutto – sono riciclabili. Uno studio condotto dalla Trucost per l'American Chemistry Council ha evidenziato che i tecnopolimeri aiutano a ridurre i costi ambientali di 4 volte rispetto alle alternative. Per costo ambientale si intende il costo in termini economici relativo alla somma di diverse problematiche quali il cambiamento climatico, il danno agli oceani e danni alla salute dell'uomo e dell'ecosistema. L'attenzione e la cura dell'ambiente hanno influito anche sull'architettura della sede di Slamp inaugurata nel 2019 alle porte di Roma: parte dell'energia assorbita dall'impianto produttivo arriva da fonti rinnovabili, l'hub produttivo è stato realizzato utilizzando materiali altamente isolanti e gli ampi lucernari sulle linee di allestimento riducono il consumo di luce artificiale.

LOW-IMPACT MANU FACTURING



COMPENDIUM 2023- 2024

SIGNATURE

COLLECTIONS

SLAMP:

SIGNATURE COLLECTIONS



Heydar Aliyev Center, Baku © Helene Binet © Zaha Hadid Architects.

“LIGHT YIELDS ENDLESS OPPORTUNITIES,
DEFINING THE WORLD AROUND US”



ZAHA
HADID

Zaha Hadid portrait © Steve Double

aria

INFINITA
BY ZAHA HADID DESIGN

technical details p.522

SUSPENSION

10TH ANNIVERSARY

To celebrate the 10 year anniversary of Slamp's collaboration with Hadid Design Studio, Zaha's iconic 2013 Aria takes on new form in a modular version

In onore del 10° anniversario della collaborazione fra Slamp e lo Studio Hadid Design nasce la versione modulare dell'iconico best seller Aria, firmato da Zaha Hadid nel 2013.



The illuminated modular system sinuously undulates throughout a space with diverse polycarbonate layers that in the lamp's highest points, reach two meters of visionary fluidity.

La scultura luminosa è composta da un corpo illuminante modulare che crea onde sinusoidali nello spazio, avvolta da layer in policarbonato tutti diversi fra loro.



Studio Hadid Design concept render
Aria Infinita Gold

technical details p. 522

SUSPENSION

SINUOUSLY UNDULATES THROUGHOUT A SPACE

Available in both total white and gold finishes: the elements are metallized through a process where an aluminum bar is vaporized in a hyperbaric chamber.

Disponibile in due finiture, total white e metallizzata in oro, metallizzazione che si ottiene tramite la vaporizzazione di una barretta di alluminio in camera iperbarica.

A CUSTOMIZABLE SYSTEM FOR SITE-SPECIFIC PROJECTS

To celebrate the 10 year anniversary of Slamp's collaboration with Hadid Design Studio, Zaha's iconic 2013 Aria takes on new form in a modular version. The illuminated modular system sinuously undulates throughout a space with diverse polycarbonate layers that in the lamp's highest points, reach two meters of visionary fluidity. The lamp's ever-evolving points of view are the fruit of careful research focused on how Lentiflex® enhances and liquifies illumination. Available in both total white and gold finishes: the elements are metallized through a process where an aluminum bar is vaporized in a hyperbaric chamber. The Slamp Team can customize solutions to any space, working alongside designers.

In onore del 10° anniversario della collaborazione fra Slamp e Zaha Hadid Design nasce la versione modulare dell'iconico best seller Aria, firmato da Zaha Hadid nel 2013. La scultura luminosa è composta da un corpo illuminante modulare che crea onde sinusoidali nello spazio, avvolta da layer in policarbonato tutti diversi fra loro che creano un disegno fluido e visionario e che, nel punto più alto della lampada, arrivano ai 2 metri di altezza. Grazie ad un attento studio sulla luce, essa cambia ed evolve a seconda del punto di osservazione: il corpo luminoso è infatti realizzato in Lentiflex®, materiale capace di fluidificare e propagare il flusso luminoso. È disponibile in due finiture, total white e metallizzata in oro, metallizzazione che si ottiene tramite la vaporizzazione di una barretta di alluminio in camera iperbarica. Realizzata su misura per progetti custom.

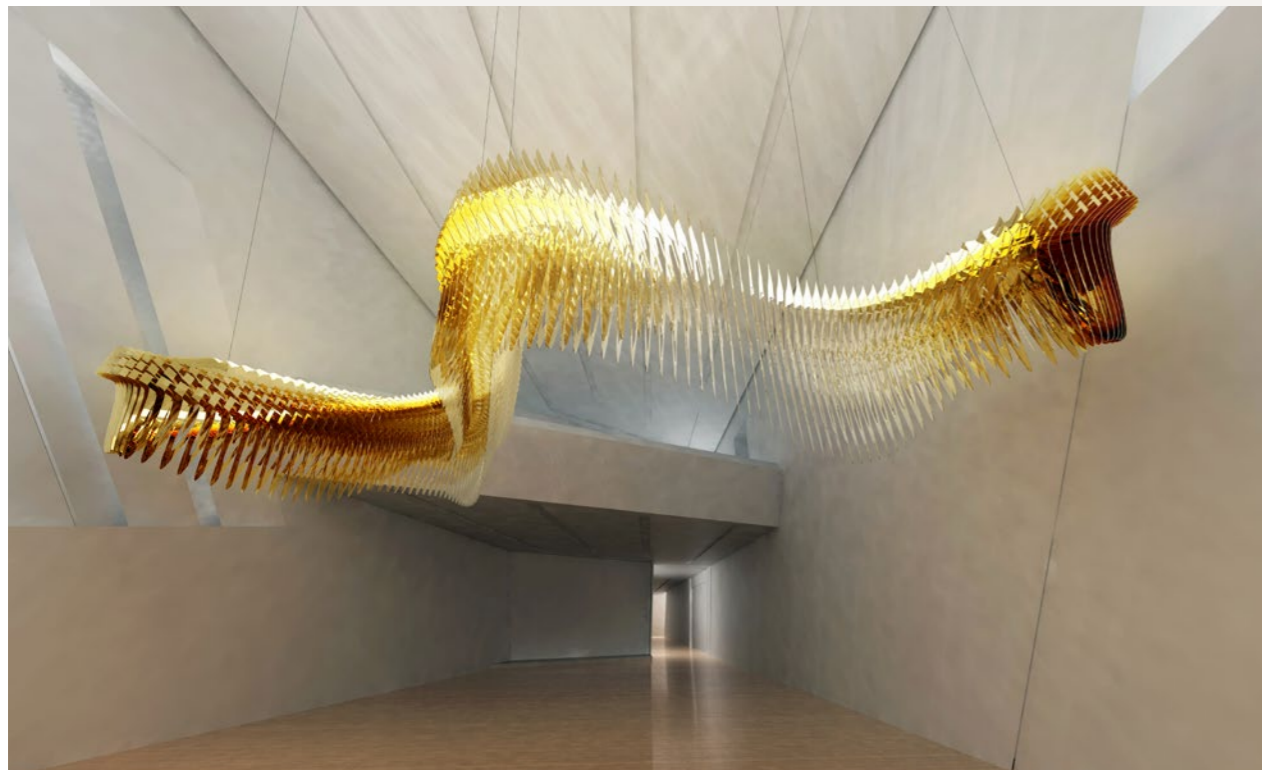

Studio Hadid Design concept render

3 ARRANGEMENTS SHOW SLAMP & ZAHA HADID STUDIO PRODUCTS' DECOR POSSIBILITIES

ARIA INFINITA ARRANGEMENT 1

30 X 12W LED Filament Bulbs + 8 x 12W Spot LED PAR 38



ARIA INFINITA ARRANGEMENT 2

54 X 12W LED Filament Bulbs + 14 x 12W Spot LED PAR 38

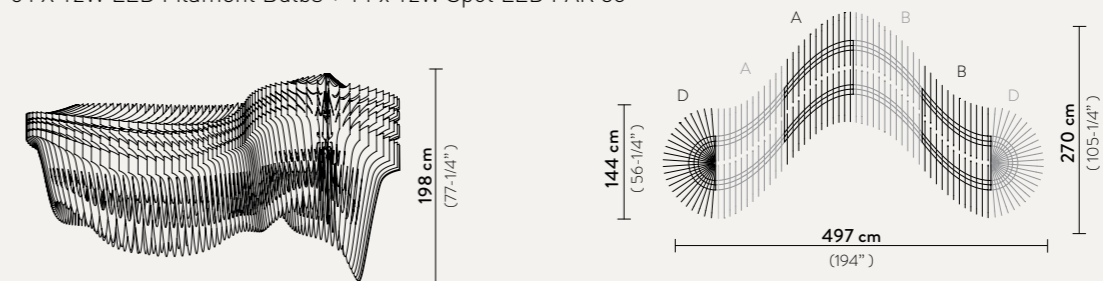

ARIA INFINITA ARRANGEMENT 3

78 X 12W LED Filament Bulbs + 22 x 12W Spot LED PAR 38

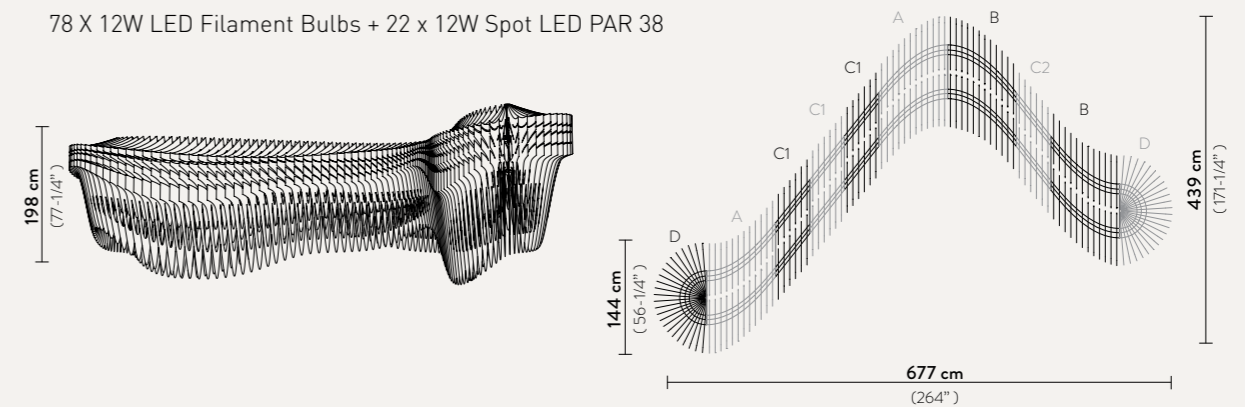

aria

GOLD
BY ZAHA HADID

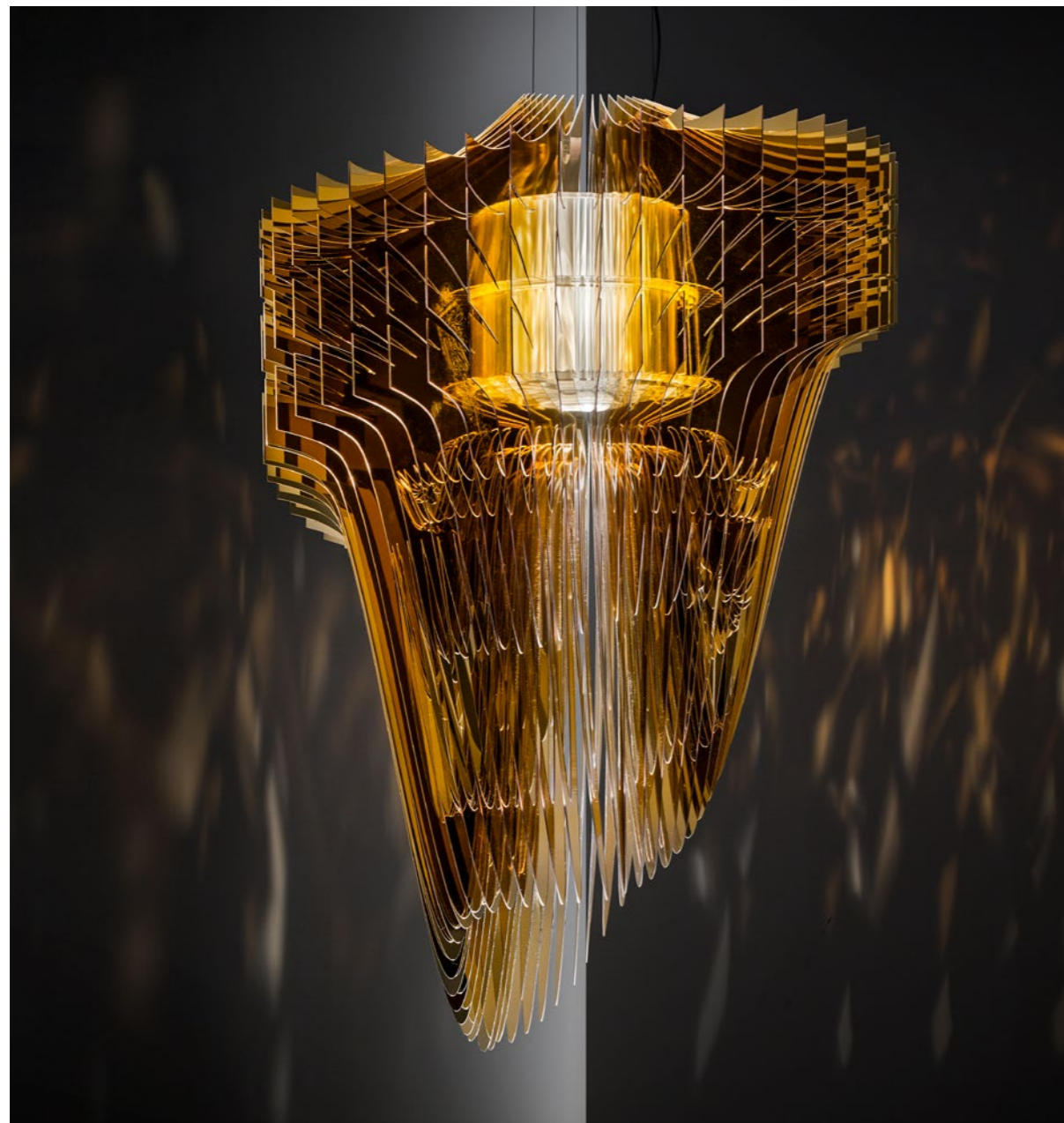

SUSPENSION

WALL LAMP
p.40

CEILING LAMP

TABLE LAMP

FLOOR LAMP



technical details p. 521



Aria Gold has Cristalflex® arms metallized in a hyperbaric chamber; each uniform piece is cut numerically, wrapped, and placed within the shipping box. Clients can rapidly and intuitively assemble the lamp.

Nella Aria Gold le lance radiali in Cristalflex® vengono prima metallizzate tramite evaporizzazione in camera iperbarica, esaminate per eliminare eventuali scarti, poi tagliate tramite un sistema a controllo numerico e infine inserite nel box, intervallate da uno strato protettivo, al fine di rendere l'installazione da parte del cliente intuitiva, veloce e piacevole.

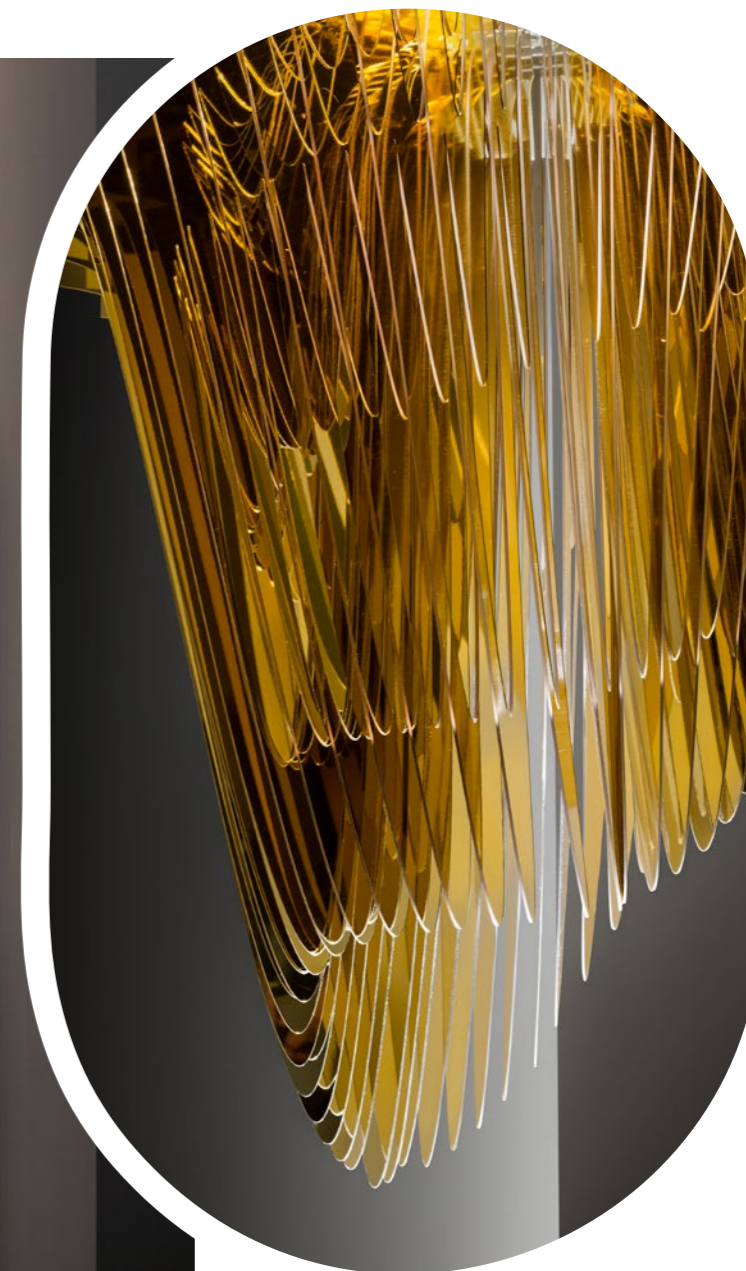

aria

TRANSPARENT
BY ZAHA HADID

technical details p. 521



- 
 SUSPENSION
- 
 WALL LAMP
p.40
- 
 CEILING LAMP
- 
 TABLE LAMP
- 
 FLOOR LAMP



PLAY VIDEO

Available in 4 sizes, ranging from Small (Ø50 cm x h. 75 cm - Ø19-3/4" x h. 29-1/2") to XL (Ø90 cm x h. 130 cm [Ø 35-1/2" x h 51-1/4"]).

Disponibile in 4 dimensioni a partire dalla Small Ø50 cm x h. 75 cm (Ø19-3/4" x h. 29-1/2") alla versione XL Ø90 cm x h. 130 cm (Ø 35-1/2" x h 51-1/4").

aria

BLACK FADE
BY ZAHA HADID



Aria XL Black Fade
Ø90 x h. 130 cm
(35-1/2" x h. 51-1/4")

-  SUSPENSION
-  WALL LAMP
-  CEILING LAMP
-  TABLE LAMP
-  FLOOR LAMP



technical details p. 521

SUSPENSION

aria

APPLIQUE
BY ZAHA HADID

technical details p. 521



WALL LAMP

- 
 SUSPENSION
p.32
- 
 WALL LAMP
- 
 CEILING LAMP
- 
 TABLE LAMP
- 
 FLOOR LAMP



Size / Dimensioni:
41 x 22 x h. 60 cm - 16" x 8-1/2" x h. 23-1/2"



25 DIFFERENT
LAYERS

avia

BY ZAHA HADID

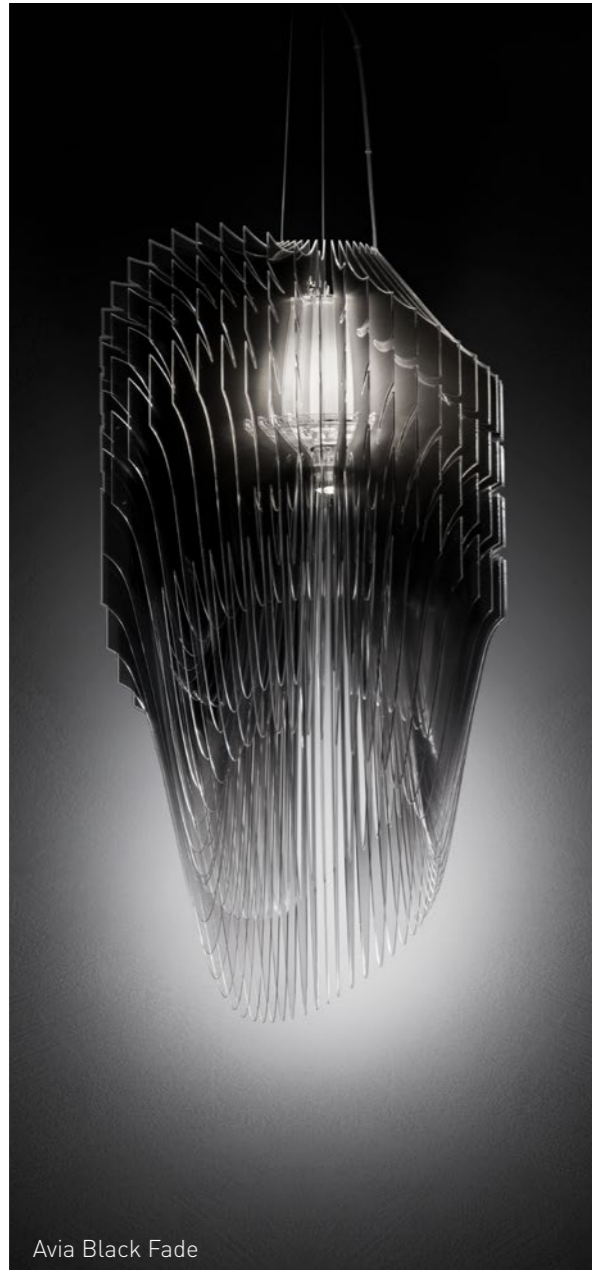

Avia Black Fade



Avia White Fade

-  SUSPENSION
-  WALL LAMP
-  CEILING LAMP
-  TABLE LAMP
-  FLOOR LAMP



technical details p. 524

SUSPENSION



Available in 4 sizes, ranging from Small (Ø45 x h. 85 cm - Ø17-3/4" x h. 33-1/2") to XL (Ø75 x h. 140 cm [Ø32-1/2" x h. 55"]).

Disponibile in 4 dimensioni dalla Small con Ø45 x h. 85 cm (Ø17-3/4" x h. 33-1/2") alla XL con Ø75 x h. 140 cm (Ø32-1/2" x h. 55")



SHA
DED

LIGHT

avia

EDITION
BY ZAHA HADID



SUSPENSION



WALL LAMP



CEILING LAMP



TABLE LAMP



FLOOR LAMP



SIGNATURE COLLECTIONS

Shenzhen Bao'An International Airport, Shenzhen, China ©Leonardo Finotti

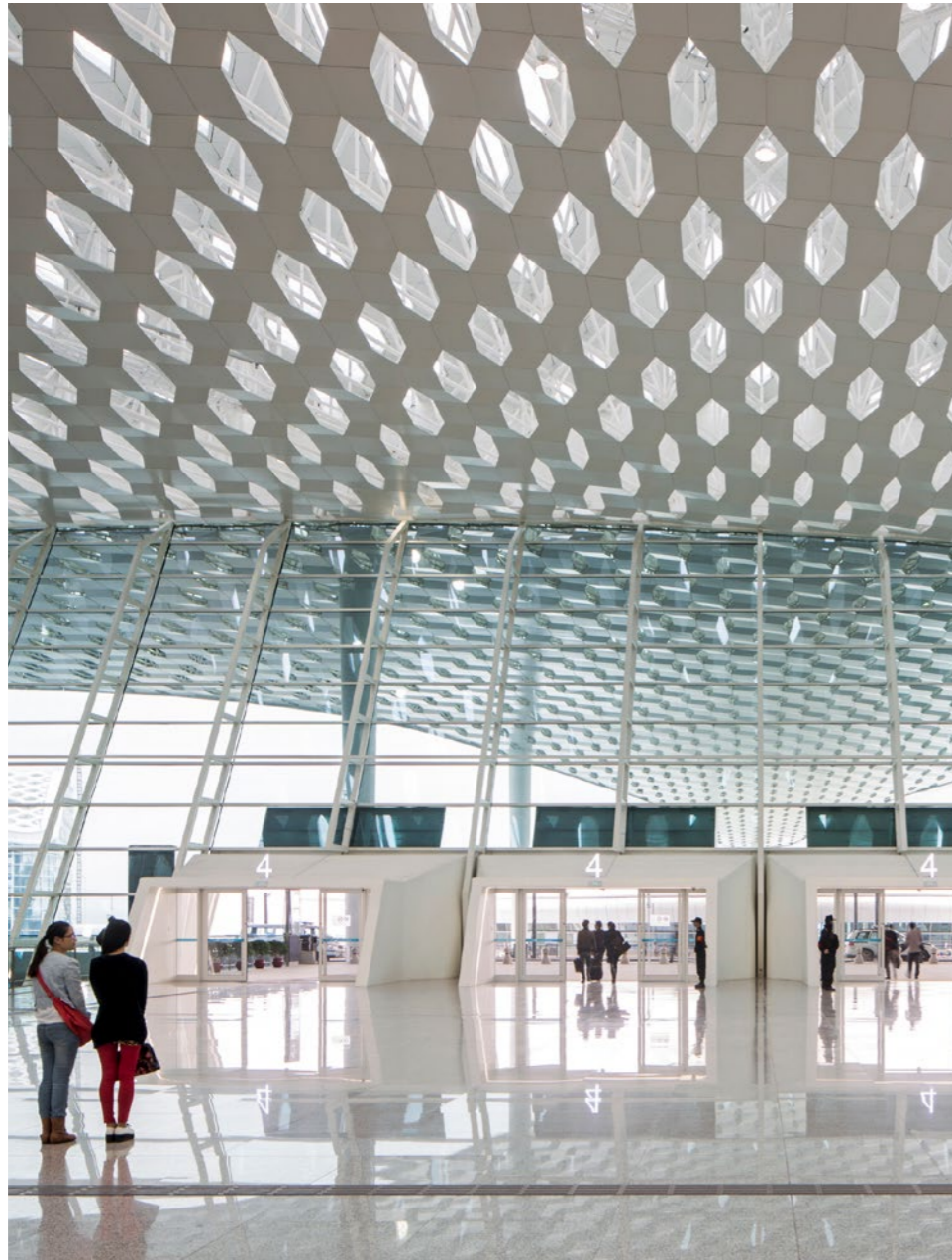

“LIGHT IS THE SOLIDITY OF ARCHITECTURE”



DORIANA AND MASSIMILIANO
FUKSAS

Doriana and Massimiliano Fuksas portrait ©Fabio Lovino

chantal

BY DORIANA AND
MASSIMILIANO FUKSAS



Lighting / Illuminazione:
M: 7 x 12W E27/E26 LED Filament Bulbs
S: 4 x 12W E27/E26 LED Filament Bulbs

-  SUSPENSION
-  WALL LAMP
-  CEILING LAMP
-  TABLE LAMP
-  FLOOR LAMP



technical details p. 529



Chantal's sculptural shape seems to be molded from a singular, industrious frame, much like honeycomb.

La forma scultorea di Chantal sembra modellarsi da un unico volume, con una trama laboriosa a tratti impalpabile, come quella del nido d'ape.

charlotte

GLOBE
BY DORIANA AND
MASSIMILIANO FUKSAS



SUSPENSION

WALL LAMP
p.64

CEILING LAMP

TABLE LAMP

FLOOR LAMP
p.60





Lighting / Illuminazione:
4 x 12W E27/E26 LED Filament Bulbs
Size / Dimensioni:
Ø60 x h 50 cm - Ø23-1/2" x h. 19"

The external layer of Cristalflex® encloses a luminous internal layer of Lentiflex®, that emits a uniform glow. Includes 4 light sources and a magnetic hanging system that makes installation and maintenance simple.

Realizzata in Cristalflex® - con una struttura interna in Lentiflex® che contribuisce alla diffusione omogenea della luce - Charlotte Globe è dotata di 4 fonti luminose e di attacco magnetico per una facile installazione e manutenzione.

MUCH LIKE HONEY COMB

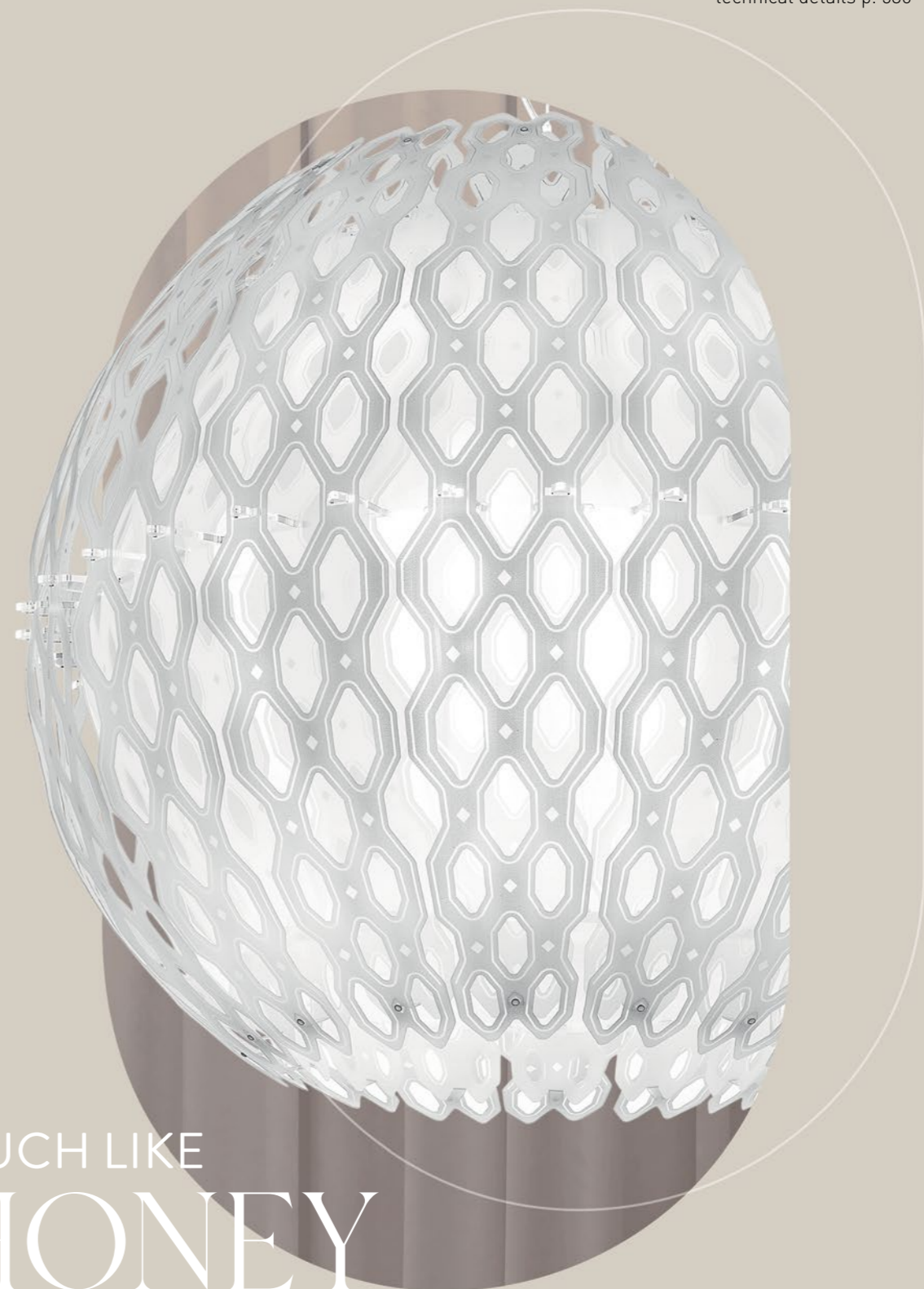

charlotte

FLOOR
BY DORIANA AND
MASSIMILIANO FUKSAS

technical details p. 530



Lighting / Illuminazione:
2 x 12W E27/E26 LED Filament Bulbs
Size / Dimensioni:
Ø32 x h.182 cm - Ø12-1/2" x h.71-3/4"

- 
 SUSPENSION
p.56
- 
 WALL LAMP
p.64
- 
 CEILING LAMP
- 
 TABLE LAMP
- 
 FLOOR LAMP



Charlotte's sculptural shape seems to be molded from a singular, industrious frame, much like honeycomb with its impalpable elements

Charlotte, in tutte le sue multiformi declinazioni, sembra modellarsi da un unico volume con una trama laboriosa, a tratti impalpabile, come quella del nido d'ape

SCULPTURAL



SHAPE

charlotte

APPLIQUE
BY DORIANA AND
MASSIMILIANO FUKSAS



Lighting / Illuminazione:
1 x 12W E27/E26 LED Filament Bulb
Size / Dimensioni:
21 x 12,5 x h. 32 cm - 8-1/4" x 5" x h. 12-1/2"



SUSPENSION
p.56



WALL LAMP



CEILING LAMP



TABLE LAMP



FLOOR LAMP
p.60



technical details p. 530

half charlotte

BY DORIANA AND MASSIMILIANO FUKSAS

technical details p. 530



Lighting / Illuminazione:
4 x 12W E27/E26 LED Filament Bulbs
Size / Dimensioni:
Ø79 x h. 55 cm - Ø31-1/4" x h. 21-1/2"



© Is Molas Resort, Sardinia, Italy.

-  SUSPENSION
-  WALL LAMP
p.64
-  CEILING LAMP
-  TABLE LAMP
-  FLOOR LAMP
p.60

SIGNATURE COLLECTIONS

La Traviata, directed by Robert Wilson. Act 1, Myung Joo Lee (Violetta Valéry) Linz, 2015 ©Lucie Jansch.



“WITHOUT LIGHT, THERE IS NO SPACE”



ROBERT
WILSON

Robert Wilson portrait ©Lucie Jansch

la traviata

LIGHT SCULPTURE
BY ROBERT WILSON



Product launch event, Milan's Triennale Teatro dell'Arte, April 2016. Robert Wilson set the stage for the inaugural dinner with a choreography of harmonious chromatic movement; La Traviata illuminated renowned Chef Genaro Esposito's delectable plates.

Evento di lancio presso il Teatro dell'Arte della Triennale di Milano, aprile 2016. Cena placè con scenografia di La Traviata realizzata da Robert Wilson, con colori e movimenti armonizzati con le portate dello chef stellato Gennaro Esposito.



Acropolis Museum, - Athens, Parthenon Gallery



PLAY VIDEO

La Traviata is a complete work of art, blending architecture, light, poetry, dance and music, where Director Robert Wilson transferred his personal dialogue between theater and light to a luminous sculpture.

La Traviata è un'opera d'arte totale: è architettura, è luce, è poesia, è danza, è movimento. Con un dialogo tra design e teatro, il drammaturgo Robert Wilson ha trasferito il suo linguaggio in una scultura luminosa.



" WITHOU + LIgh +
 + there is
 NO SPACE "

robert WILSON

SIGNATURE COLLECTIONS



Dresden Museum of Military History ©Hufton+Crow

“LIGHT IS PURE LOVE”



DANIEL
LIBESKIND

D. Libeskind portrait ©StefanRuizbn

cordoba

BY DANIEL LIBESKIND



Lighting / Illuminazione:
LED 130W-110 ~240 Vac /24 Vdc
15.000 Lumen 3000 Kelvin - CRI >90
Size / Dimensioni:
76 x 104 x h.55 cm - 30" x 41" x h. 21"

-  SUSPENSION
-  WALL LAMP
-  CEILING LAMP
-  TABLE LAMP
-  FLOOR LAMP



technical details p. 532



A mathematical algorithm combines two dimensional technopolymer sheets into a suspension that harmoniously glows. Cordoba is handcrafted, offering endless angles from every viewpoint.
Lastre bidimensionali di tecnopolimeri prendono vita da un algoritmo matematico e diffondono la luce in maniera armonica. Cordoba è allestita completamente a mano, offrendo diversi punti di vista a chi la osserva nella sua interezza.

A HANDCRAFTED



ALGO
RITHM

COMPENDIUM 2023- 2024

MODULAR

COLLECTIONS

SLAMP:

tulip

BY MARC SADLER

technical details p. 553-554

SUSPENSION



SUSPENSION



WALL LAMP



CEILING LAMP



TABLE LAMP
p.334



FLOOR LAMP



2 Tulip 14 Linear

The Linear and Round canopies feature Designer Marc Sadler's predetermined cascading compositions powered by Plug and Play solutions.

Nelle disposizioni Linear e Round le cascate di tulipani sono predeterminate dal Designer Marc Sadler per una soluzione allestitiva Plug & Play.



Tulip 14 Round

TULIP ROUND CANOPY



The 50cm/ 19-1/2" brushed brass canopy hosts 7 to 14 handcrafted blooms. Just like the Linear Canopy, the cascade arrives in a predetermined composition designed by the Designer, featuring a Plug & Play solution. The blooms hang from the ceiling rose on thin steel cables, and their height can be adjusted during installation to fit the space.

Il rosone in ottone spazzolato di 50 cm di diametro ospita 7 o 14 fiori realizzati a mano. Come nella versione Linear Canopy, anche in questa la disposizione dei Tulipani nella cascata di luce è predeterminata dal Designer per una soluzione allestitiva Plug & Play. L'altezza dei fiori, fissati al rosone con sottili cavi d'acciaio, è gestibile in fase di installazione per assecondare lo stile e la necessità dell'ambiente in cui è inserito.

TULIP FREE-STANDING



Multiples of 14 are available to create dramatic installations anchored to the ceiling with small brushed brass fixtures that can be placed where desired. To help with installation, Slamp includes two illustrations of how the 14 blooms can be placed. This system allows for more aesthetic and technical control than the ceiling rose solutions, including connection to a single electrical source and the creation of a multi-point lighting chain using thinly braided copper wires.

Disponibile in multipli di 14 per creare scenografiche installazioni, questa edizione può essere ancorata al soffitto tramite piccoli fissaggi in ottone spazzolato posizionabili alla distanza desiderata. Per facilitare l'installazione, Slamp fornisce due dime con il disegno dei 14 fori. Questa soluzione lascia libertà compositiva pur mantenendo le stesse caratteristiche estetiche e tecniche delle soluzioni con rosone, come la connessione a un unico attacco elettrico e il concatenamento dei vari punti luce tramite il sottile cavo di rame intrecciato.

TULIP LINEAR CANOPY



The Tulip modular system has rectangular blooms and a Plug & Play system. Seven to fourteen Tulips hang from the brushed brass canopy (size ranging from 70 cm / 27-1/4" to 110 cm / 43" depending on the number of blooms) on thin steel cables positioned in an almost weightless, harmonious predetermined composition created by the Designer. Create a personalized flurry of blooms by anchoring the ceiling bracket and connecting the Tulip cluster, adjusting height to the project.

Nella versione con rosone rettangolare, il sistema modulare Tulip è proposto in una composizione Plug & Play. 7 o 14 Tulipani discendono dalla coppetta in ottone spazzolato (di 70 o 110 cm in base al numero di fiori) tramite dei sottili cavi di acciaio posizionati dal Designer in una composizione predeterminata, armonica e leggera. Sarà sufficiente ancorare la staffetta al soffitto e poi sollevare il cluster di Tulip creando una sinusoide di fiori ad altezze variabili secondo il proprio gusto.

EASILY ADJUSTED HEIGHT

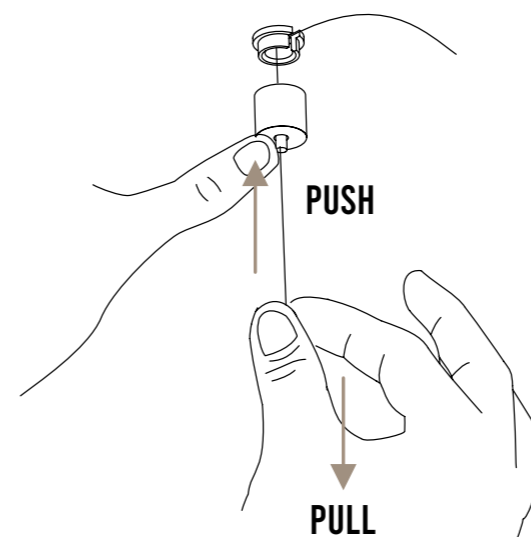

The height of Tulip's blooms can be adjusted using the push and pull system, even after installation. Release the clamp to loosen steel cables, thread them upwards gently until they reach the desired height, and then tighten the clamp.

Tulip dà la possibilità di regolarne l'altezza una volta sospesa, tramite il sistema Push-Pull posto sull'appendimento di ogni singolo Tulipano. Basterà svitare il morsetto per rilasciarlo, spingerlo verso l'alto e tirare delicatamente il cavo in acciaio per poi serrare il morsetto avvitandolo, fissando così il cavo all'altezza desiderata.



This Page: a free-standing cascade of 147 blooms. Next page: a free-standing composition of 154 blooms.
In questa pagina: una composizione free standing da 147 tulipani, nella pagina successiva da 154.



technical details p. 553-554



Slamp's exclusive, unbreakable Lentiflex® technopolymer is manually sculpted at a controlled temperature to create an illuminated bloom.

La modellazione manuale a temperatura controllata del Lentiflex®, tecnopolimero infrangibile di Slamp, dà vita ai boccioli luminosi di Tulip.

HAND
MOLDED



BLO
OMIS



This Page: a free-standing composition of 154 blooms. Next page: a free-standing cascade of 441 blooms.
In questa pagina: una composizione free standing da 154 tulipani, nella pagina successiva una cascata di 441.

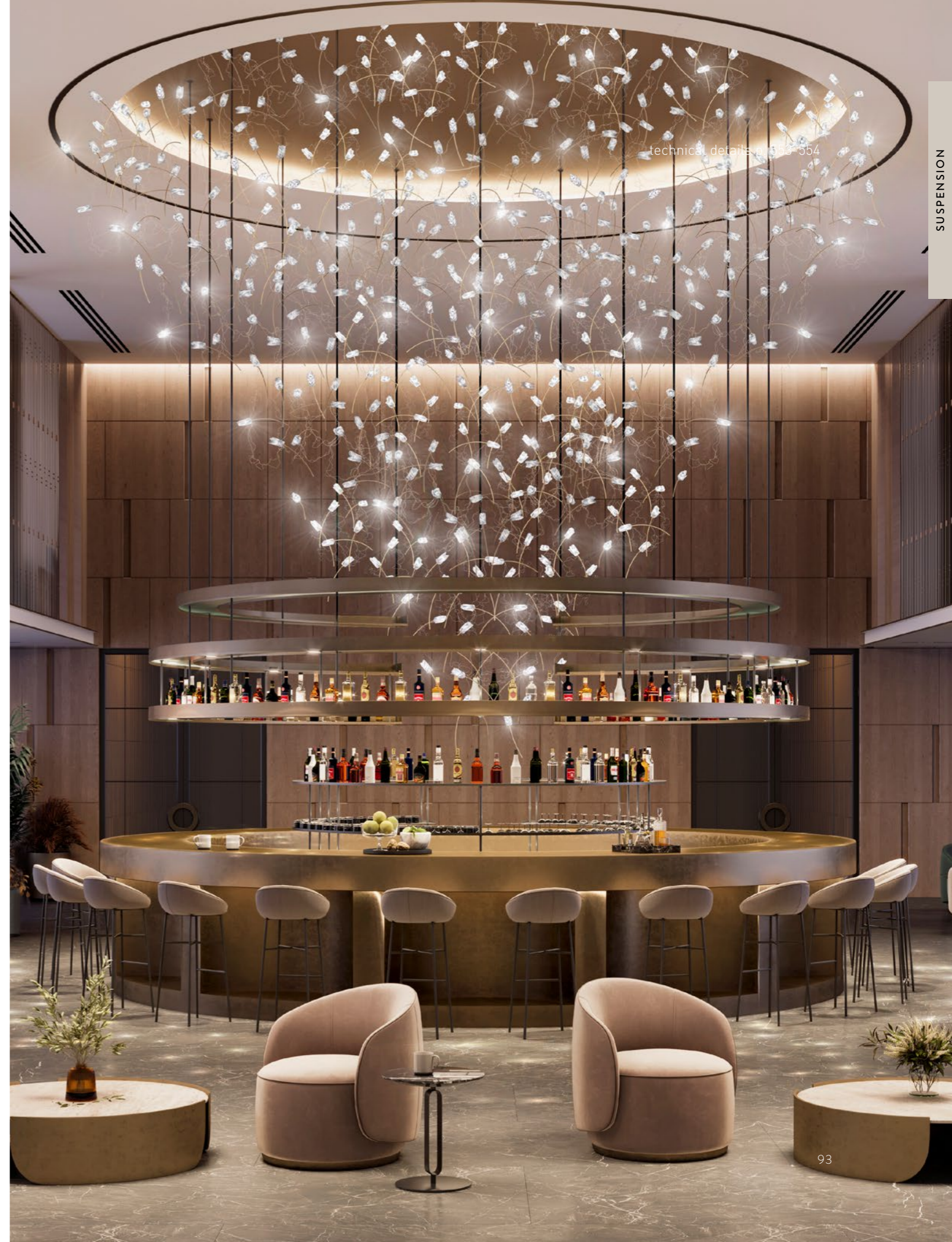

technical details p. 553-554

SUSPENSION

nuvem

MODULAR SYSTEM
BY MIGUEL ARRUDA



Vila Franca de Xira Municipal Library, Portugal.

-  SUSPENSION
-  WALL LAMP
-  CEILING LAMP
-  TABLE LAMP
-  FLOOR LAMP



technical details p. 550

SUSPENSION



Pictured: 3 overlapping bands of Nuvem create a composition of 115 modules in a reception area.

Nella foto: una reception con 3 strati di Nuvem che creano una composizione di 15 moduli.



Pictured: 616 1 sq.m modules with 122 bidirectional spotlights.
Nella foto: 616 moduli da 1 mq con 122 spotlights bidirezionali.

PLAY VIDEO

INFINITE EXTENSIONS IN EVERY DIRECTION

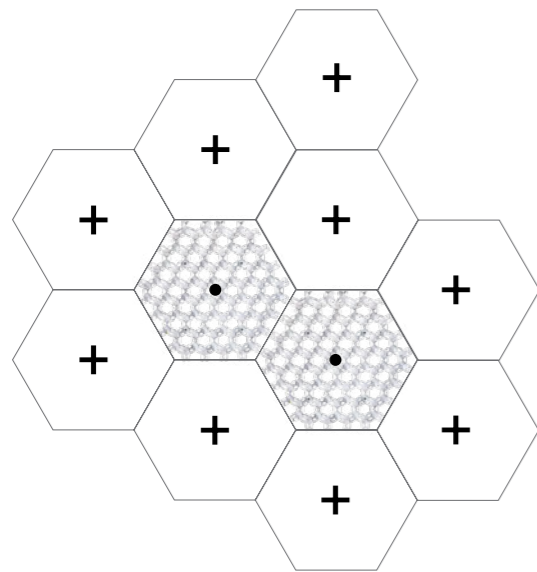

The meter-long hexagonal elements are easily connected by hand using a series of interlocking tabs that allow for limitless omnidirectional installation. The modules facilitate the adaptable and mutable personalization of private and contract spaces, adding a strong artistic note to each.

Gli elementi esagonali di un metro quadro, tramite un semplicissimo sistema di connessioni eseguibili a mano, si uniscono gli uni agli altri espandendosi in ogni direzione, per personalizzare gli ambienti con design sempre diversi e aggiungere una forte connotazione artistica ad abitazioni private e strutture ricettive.

PERSONALIZED SPOTLIGHTS

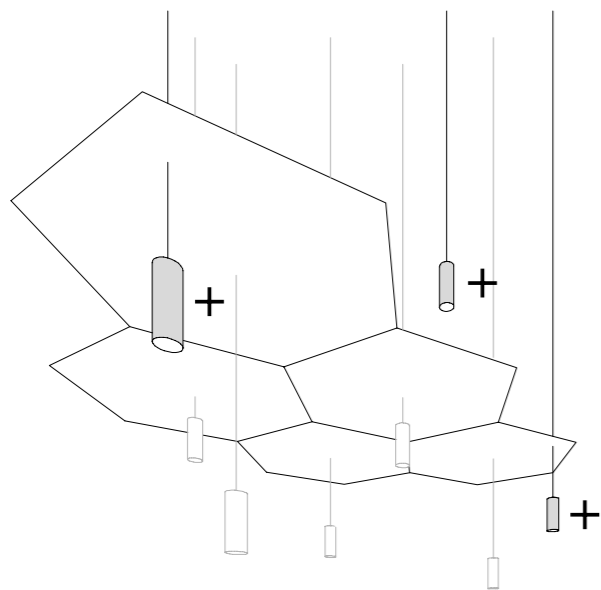

Nuvm's lighting system is a series of bidirectional spotlights (one per square meter) that can be positioned above or below (threaded through the modules' openings). Additional spotlights can be purchased separately for compositions that require amplified illumination.

Il sistema luminoso di Nuvm è composto da una serie di faretti con emissione bidirezionale (uno per ogni mq) che possono essere calati al di sotto del modulo decorativo, passando tramite i fori della composizione, o sollevati al di sopra della struttura. In presenza di particolari necessità compositive, eventuali faretti aggiuntivi possono essere acquistati separatamente.

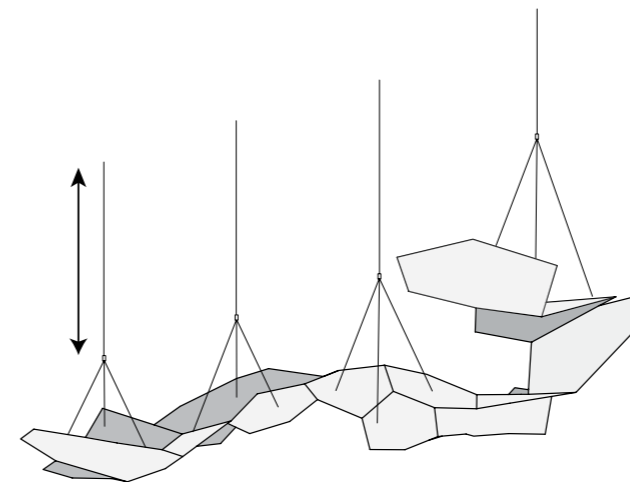

ADJUSTABLE HEIGHT

Nuvm's height can be adjusted using the 6 meter cable, and once suspended, the design can be "molded" using the push and pull system located directly beneath each module. The lamp collapses or tenses when the wires are pushed (released) or pulled, giving the ceiling a fluctuating feeling.

Oltre alla regolazione dei cavi fino a 6 metri, Nuvm dà la possibilità di modulare il design dell'oggetto, una volta sospeso, tramite il sistema "push and pull" posto direttamente al di sotto del modulo decorativo. Tirando o rilasciando i singoli cavi, la lampada si anima – collassando o stirandosi – per dare forma a un "soffitto" fluttuante.

FROM A LAMP TO A VERTICAL DECORATION

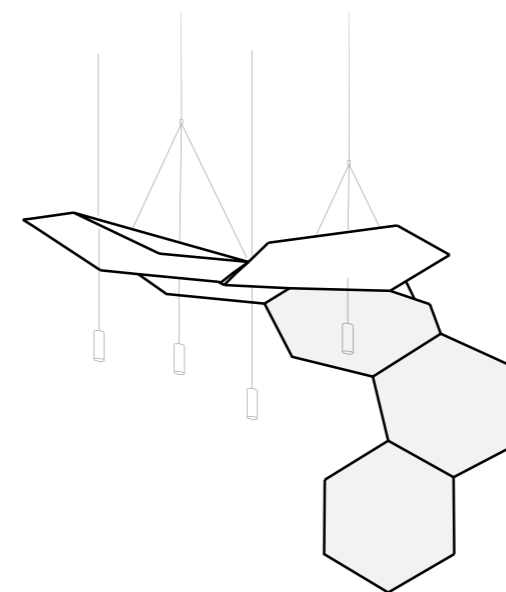

Weightless and free...just like a cloud. Nuvm goes beyond traditional illumination, with agile anatomy that allows it to transform the architectural elements of a space, running across the ceiling and moving down the walls, creating an infinite sky.

Leggera e libera come una nuvola, Nuvm va oltre la semplice illuminazione tradizionale: l'agilità della sua anatomia le permette di enfatizzare gli elementi architettonici trasformandosi da "soffitto" a decoro, calando sulle pareti per eliminare ogni confine tra cielo e terra della stanza



Single module size: 102 x 94 x h. 6 cm - 39-3/4" x 36-1/2" x h 2-1/4". Modules of 1 sq. meter can be joined in infinite combinations; bidirectional illumination. Pictured: 70 velvet modules.

Dimensioni modulo singolo: 102 x 94 x h. 6 cm - 39-3/4" x 36-1/2" x h 2-1/4". Moduli da 1 mq con luce bidirezionale componibili all'infinito. Nella foto 70 moduli velvet.



technical details p. 550

Installation of 17 velvet modules.
Installazione di 17 moduli velvet.



84 modules with 16 bidirectional spotlights. Additional spotlights can be purchased to amplify illumination.
84 moduli con 16 spot bidirezionali. Ulteriori punti luce possono essere acquistati per amplificare l'illuminazione.

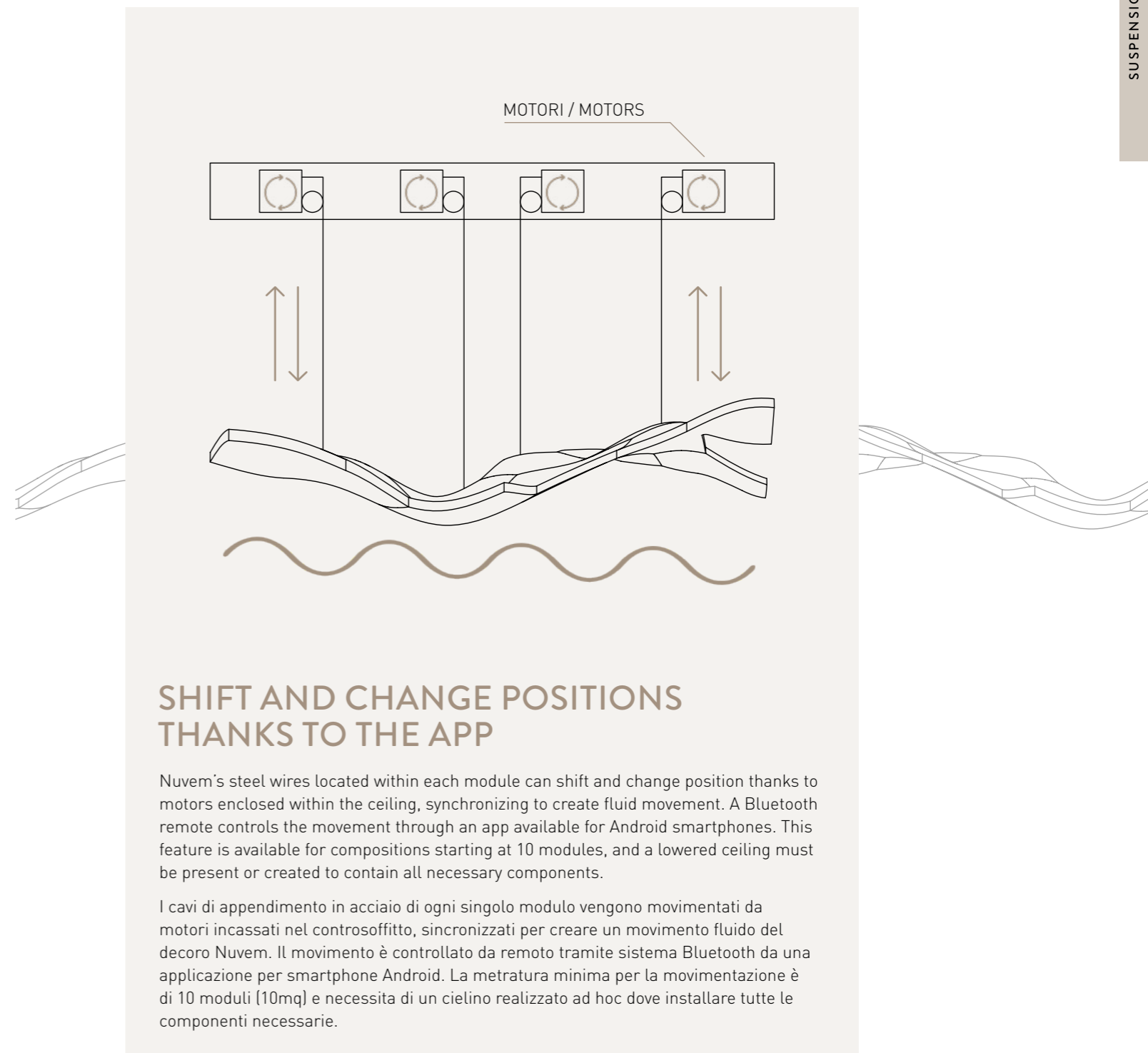



The 1 sqm modules have been handcrafted, really tailored, by Slamp's artisans; each can be connected thanks to a quick, intuitive, easy to install system that uses simple tabs.

I moduli da 1 mq sono pre-allestiti a mano dalle Sarte della Luce di Slamp e si possono collegare l'uno all'altro tramite dei semplici bottoni, rendendo l'installazione rapida e intuitiva.



hugo

BY SLAMP CREATIVE DEPARTMENT



-  SUSPENSION
-  WALL LAMP
-  CEILING LAMP
-  TABLE LAMP
-  FLOOR LAMP
p.492



technical details p. 541

SUSPENSION

Pictured: a composition of 300 modules.
Composizione di 300 moduli



PLAY VIDEO

Pictured: a customized version of Hugo Vertical 50 cm above table surfaces.
 Nella foto una versione customizzata da 50 cm illumina dei tavoli di un ristorante.



technical details p. 541

SUSPENSION

Pictured: 377 vertical modules.
 In foto: 377 moduli verticali.

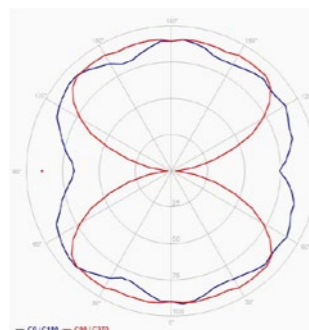

PHOTOMETRIC DIAGRAM, HUGO.
DIAGRAMMA FOTOMETRICO DELLA HUGO.

COMPLIANT WITH THE UNI EN 12464-1:2011 STANDARD

Hugo offers the same qualities of traditional technical lighting without losing Stamp's iconic aesthetic value. The main office requirements established in the UNI EN 12464-1:2011 require an average illumination of 500 lx on work surfaces, a uniformity coefficient U0 greater than 0.6, and a glare value (UGR) of less than 19. Both the Prisma and White versions conform to these requirements, including a CRI (colour rendering index) greater than 90.

Hugo offre una qualità di luce paritetica a quella degli apparecchi per illuminazione tecnica, in aggiunta al valore estetico tipico dei prodotti Stamp. I principali requisiti illuminotecnici per gli uffici, così come stabiliti all'interno della norma UNI EN 12464-1:2011 prevedono un livello di illuminamento medio sul piano di lavoro pari a 500 lx, un coefficiente di uniformità U0 maggiore di 0,6 e un valore di abbagliamento (UGR) minore di 19. I calcoli illuminotecnici eseguiti sia con la fotometria della versione Prisma che della White dimostrano la completa rispondenza dei progetti ai parametri richiesti, incluso l'indice di Resa Cromatica (CRI) > 90.



MAXIMUM FLEXIBILITY

One to seven one-meter luminous modules can be connected through a single electrical output using cables, allowing the flexibility to position modules 28 cm (11") from one another at varying angles.

Da 1 a 7 moduli luminosi da un metro di lunghezza possono essere connessi tra loro tramite un unico attacco elettrico e dei cavi di collegamento. La flessibilità di quest'ultimi permette di posizionare i moduli fino a 28 cm di distanza tra loro e in diverse angolazioni.

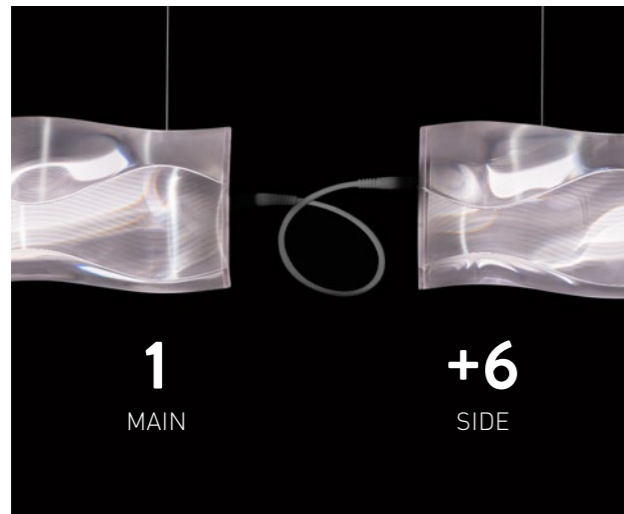

CONNECTION CABLE
28 cm (11")

HOW TO MODULATE THE INSTALLATION

The Hugo collection includes both vertical and horizontal single modules, and the Architectural allows for up to 7 interconnected elements. The wide range of offer allows for creating unique, original, and easily installed solutions that can go beyond any limit.

La collezione Hugo include sia moduli orizzontali e verticali singoli, che il sistema Architectural fino a 7 elementi interconnessi. L'ampiezza della proposta permette di valicare i limiti del "finito" modulando facilmente installazioni originali e uniche.



VERTICAL AND ORIZZONTAL MODULES,
WHITE AND PRISMA FINISHING

COMPLIANT WITH THE UNI EN 12464-1:2011 STANDARD

Hugo offers the same qualities of traditional technical lighting. The main office requirements established in the UNI EN 12464-1:2011 require an average illumination of 500 lx on work surfaces, a uniformity coefficient U0 greater than 0.6, and a glare value (UGR) of less than 19.

Hugo offre una qualità di luce paritetica a quella degli apparecchi per illuminazione tecnica. I principali requisiti illuminotecnici per gli uffici prevedono un livello di illuminamento medio sul piano di lavoro pari a 500 lx, un coefficiente di uniformità U0 maggiore di 0,6 e un valore di abbagliamento (UGR) minore di 19.

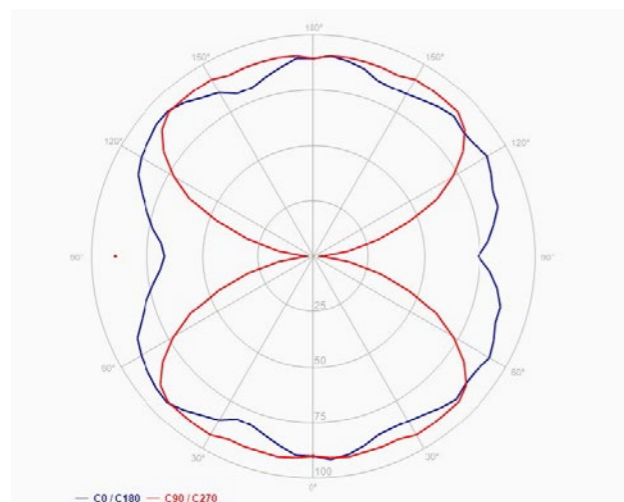

PHOTOMETRIC DIAGRAM, HUGO.
DIAGRAMMA FOTOMETRICO DELLA HUGO.

ALIGNMENT ROD

If the composition requires further stability when the modules are positioned horizontally, 14,5 cm / 5-3/4" magnetic, transparent alignment rod are available.

Se la composizione ideata prevede un maggior rigore e si desidera allineare tra loro i moduli disposti in orizzontale, può essere fornita una barra di allineamento con attacco magnetico trasparente di 14,5 cm di lunghezza.

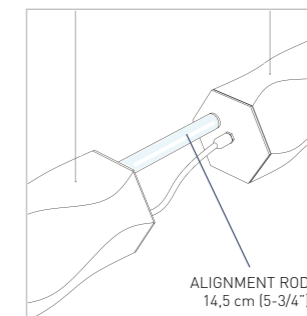



Every module has a co-axis cable that creates clean lines and easy installation.

Ciascun modulo luminoso è dotato di cavo coassiale di appendimento per avere linee pulite e agevolare l'installazione.

HAND
MADE



IN
ITALY



Pictured: 2 Hugo Architectural 2 and Hugo Floor.
In foto: due moduli di Hugo Architectural 2 e Hugo Floor.



Pictured / In foto: Hugo Architectural 2
40W - 100-240V / 24Vdc - 7000 Lumen - 3000 Kelvin
Dimmable with: PWM, 0-10

SUSPENSION

LAMPS

SLAMP:

quantica

BY ADRIANO RACHELE



Size / Dimensioni:
Quantica 120: Ø122 x h.68 cm (Ø48" x h. 26-1/2")
Quantica 75: Ø74 x h.43 cm (Ø29" x h. 16-3/4")

-  SUSPENSION
-  WALL LAMP
-  CEILING LAMP
-  TABLE LAMP
-  FLOOR LAMP



technical details p. 552

Quantica 120



Quantica 120

Lighting / Illuminazione:
Quantica 120: 8 x 12W E26/E27 LED Filament Bulbs - Quantica 75: 4 x 12W E26/E27 LED Filament Bulbs.



Quantica 120

A cold application of gold foil creates a unique texture that printing or paints cannot replicate.
La lamina dorata viene applicata a freddo sul materiale creando un effetto materico irriproducibile con vernici o stampe.



Quantica 75 bottom view

Quantica was inspired by the intangible, delicate energy that connects all things through never-ending ties that follow precise geometric parameters.

Quantica si ispira alla maglia energetica sottile e intangibile che connette tutte le cose, un concatenarsi di infiniti che rispondono a precise regole geometriche.



technical details p. 552

Quantica 120

la belle étoile

BY ADRIANO RACHELE



SUSPENSION



WALL LAMP
p.452



CEILING LAMP
p.308



TABLE LAMP



FLOOR LAMP

technical details p. 543

SUSPENSION



Large

Medium

The finish is a non-toxic silk-screen print on Cristalflex®.

Il decoro è ottenuto mediante stampa serigrafica su Cristalflex® trasparente utilizzando inchiostri atossici.





Size / Dimensioni:

L: Ø90 x h. 55 cm - 35-1/2" x h. 21-3/4" - M: Ø73 x h. 43 cm - 28-1/2" x h. 17-3/4".

Lighting / Illuminazione:

Large and Medium: 21W - 110-240 Vac/40 Vdc - 2.830 Lumen - 2700 Kelvin - CRI 90 - Dimmable



technical details p. 543



MAGNETIC LED SOURCE

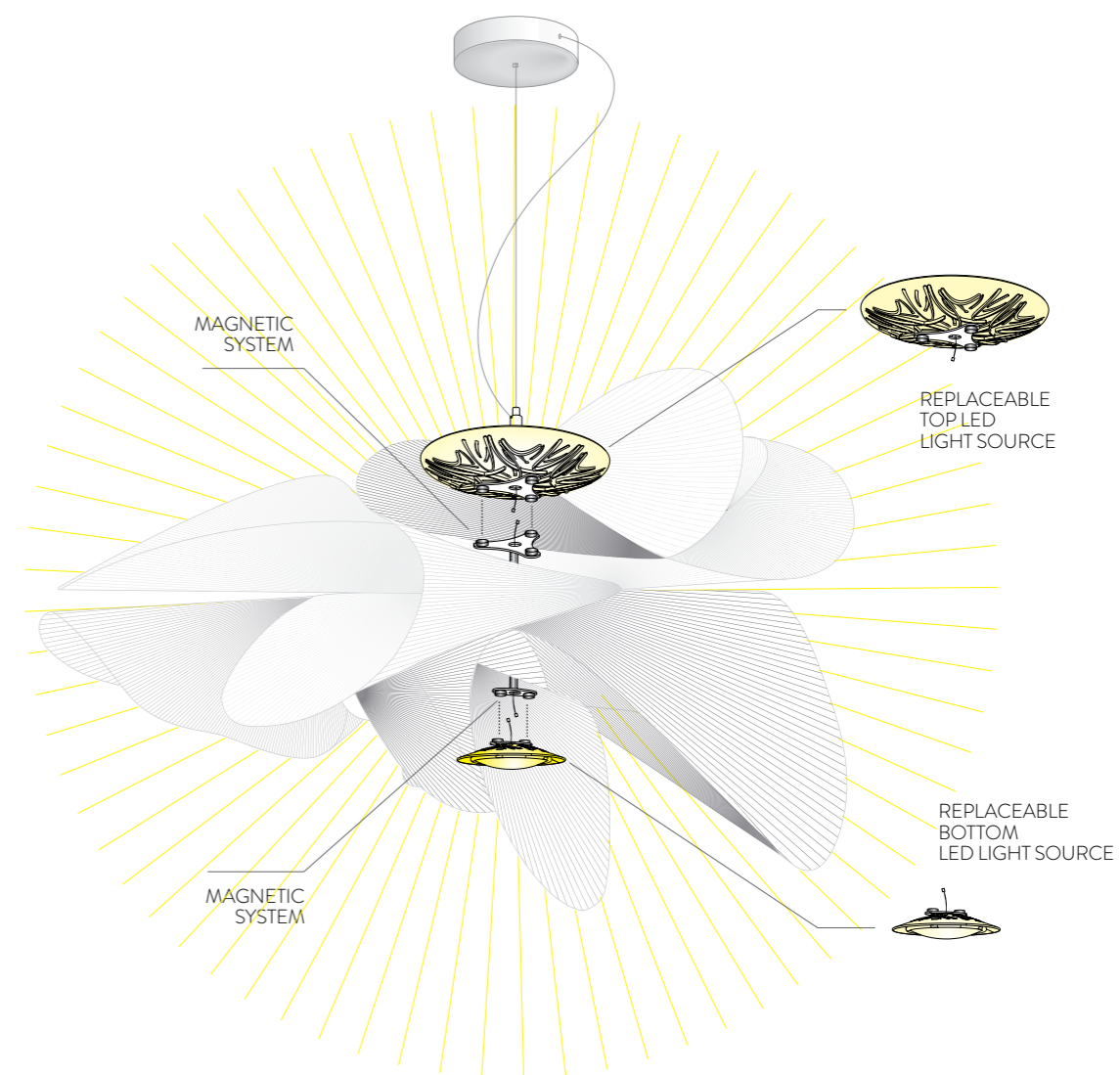

THE LED SOURCE CAN BE **EASILY** AND QUICKLY CHANGED

Light, dynamic, and as elegant as a twirling ballerina. La Belle Étoile is handmade by Slamp's artisans, experts in both manual art and technology. The ad hoc LED source can be easily changed thanks to Slamp's patented magnetic system.

Dinamica, leggera ed elegante come una ballerina dai volteggi aggraziati. La Belle Étoile è realizzata a mano dalle Sarte della Luce di Slamp, unendo artigianalità e tecnologia: il circuito a LED realizzato ad hoc è sostituibile tramite il sistema magnetico brevettato da Slamp.

étoile

BY ADRIANO RACHELE



Size / Dimensioni:
L: Ø90 x h.55 cm - Ø35-1/2" x h. 21-3/4" - M: Ø73 x h. 43 cm - Ø21" x h. 17-



SUSPENSION



WALL LAMP
p.454



CEILING LAMP
p.310



TABLE LAMP



FLOOR LAMP



technical details p. 535

SUSPENSION

Lighting / Illuminazione:
L and M: 21W - 110-240 Vac/40 Vdc
2830 Lumen, 2700 K, CRI 90, Dimmable.

Crystal counter-balance "drop" included.
Contrappeso in cristallo incluso.

clizia

MAMA NON MAMA

BY ADRIANO RACHELE

technical details p. 531

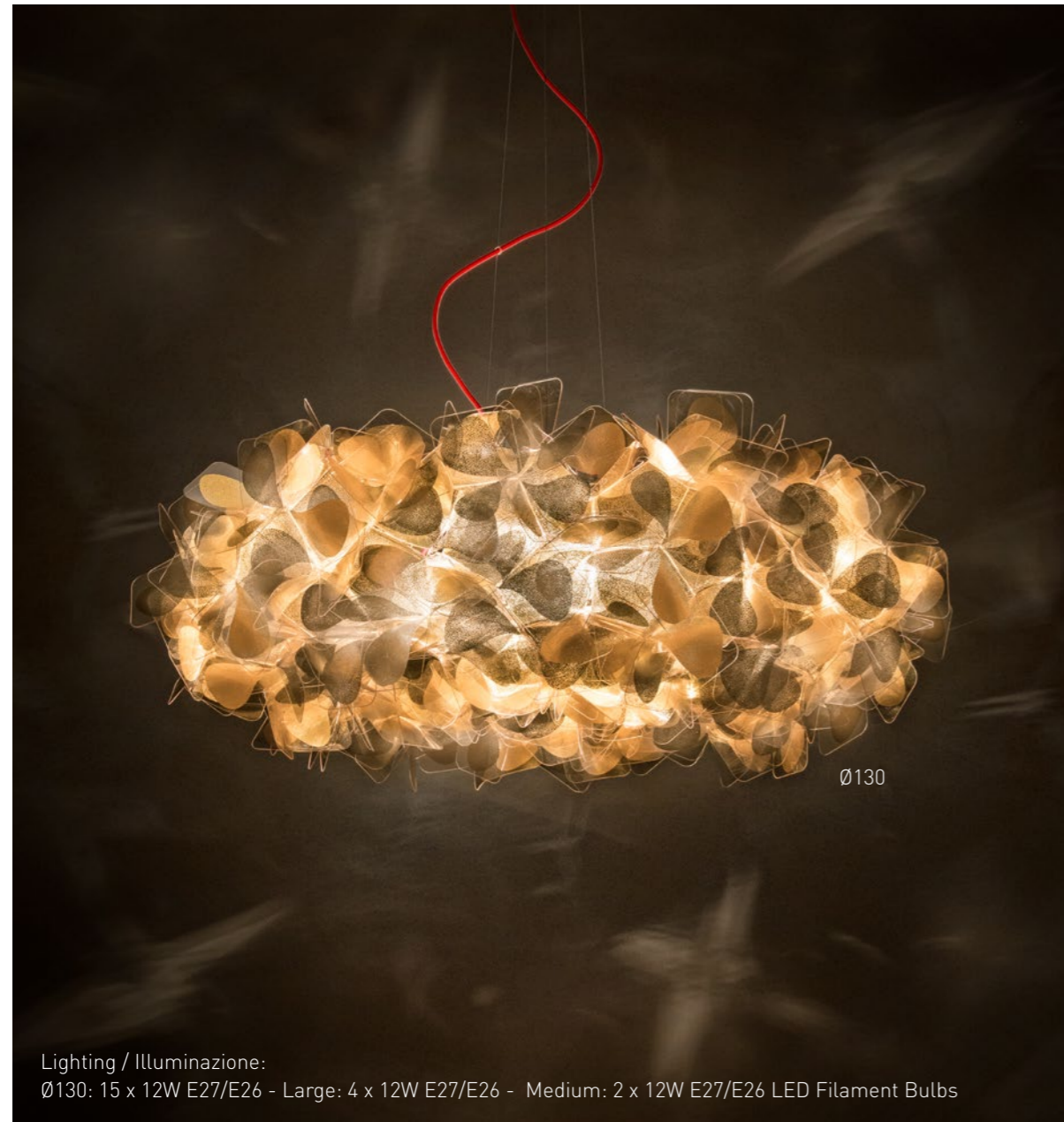

- 
 SUSPENSION
- 
 WALL LAMP
 p.404
- 
 CEILING LAMP
 p.262
- 
 TABLE LAMP
 p.348
- 
 FLOOR LAMP

CHOOSE YOUR CLIZIA



PRECIOUS
MAMA NON MAMA **GOLD**



DELICATE
MAMA NON MAMA **WHITE**



STYLISH
MAMA NON MAMA **BLACK**



M: Ø53

L: Ø78

The red hanging wire gives a creative touch, but for those looking for something minimal, a transparent one is available.
 Il cavo rosso, che aggiunge al prodotto un guizzo creativo, può essere richiesto anche trasparente.



M: Ø53

L: Ø78

Size /Dimensioni:
 L: Ø78 x h. 28 cm
 Ø30-3/4" x h.11"
 M: Ø53 x h. 25 cm
 Ø20-3/4" x h. 9-3/4"



The Clizia 130 touches on the "more is more" approach to installations without compromising the palpable weightlessness that defines Slamp's creations.

La Clizia 130 permette installazioni in spazi più ampi enfatizzando il concetto del "more is more" mantenendo la leggerezza caratteristica di ogni produzione Slamp.



technical details p. 531

Ø130

clizia

FUMÉ
BY ADRIANO RACHELE





L: Ø78

M: Ø53

Cristalflex® is shiny and transparent as crystal, but light, unbreakable and flexible as a polycarbonate.
Il Cristalflex® è brillante e trasparente come il cristallo ma leggero e infrangibile come il policarbonato.



UNIQUE
SHA
PES

clizia

PIXEL
BY ADRIANO RACHELE

technical details p. 531



Lighting / Illuminazione:
Large: 4 x 12W E27/E26
LED Filament Bulbs
Medium: 2 x 12W E27/E26
LED Filament Bulbs

-  SUSPENSION
-  WALL LAMP
p.414
-  CEILING LAMP
p.270
-  TABLE LAMP
-  FLOOR LAMP

clizia

BY ADRIANO RACHELE



Clizia Suspension Blue, exclusively available in a Medium version.
La colorazione Blu è disponibile solo nella versione Clizia Suspension Medium.

- 
 SUSPENSION
- 
 WALL LAMP
p.416
- 
 CEILING LAMP
p.272
- 
 TABLE LAMP
p.360
- 
 FLOOR LAMP



technical details p. 531

modula

BY ELISA GIOVANNONI

technical details p. 549



Modula Black - Plissé



Modula Double Light Gray - Crystal

- 
 SUSPENSION
- 
 WALL LAMP
- 
 CEILING LAMP
- 
 TABLE LAMP
- 
 FLOOR LAMP
 p.474

Size / Dimensioni:
 Single: 96 x 5,5 x h.10 cm - 37-1/2" x 2" x h.4"
 Double: 192 x 5,5 x h.10 cm - 74-3/4" x 2" x h. 4"



The Plissé effect recreates illuminated spiraling columns often used in architecture.
L'effetto "Plissé" ricrea con la luce il disegno a spirale delle colonne tortili utilizzate in architettura.



Lighting / Illuminazione:
 Single: LED 35W - 100-240Vac/24Vdc
 3.771 lumen - 3000 Kelvin
 Dimmable with: PWM, 0-10
 Double: LED 70W - 100-240Vac/24Vdc
 7.542 lumen - 3000 Kelvin
 Dimmable with: PWM, 0-10

Modula Double Black - Crystal



CRYSTAL EFFECT

Size / Dimensioni:
Single: 96 x 5,5 x h.10 cm
37-1/2" x 2" h.4"
Double: 192 x 5,5 x h.10 cm
74-3/4" x 2" x h.4"

The Crystal effect casts a sophisticated, shining jewel-like effect over a soft surface.
L'effetto Crystal ricorda un'impuntura di strass su una superficie morbida, ricreando un effetto brillante e sofisticato.



UPPER LIGHT
LUCE SUPERIORE

PLISSÉ OR CRYSTAL EFFECT DIFFUSOR
DIFFUSORE EFFETTO PLISSÉ O CRYSTAL



technical details p. 549

Modula Double Black - Plissé

SUSPENSION

kalatos

BY ELISA GIOVANNONI



Kalatos Prisma



technical details p. 542

Kalatos Black/Gold

SUSPENSION

-  SUSPENSION
-  WALL LAMP
-  CEILING LAMP
p.286
-  TABLE LAMP
-  FLOOR LAMP



Size /Dimensioni:
Ø63 x h. 30 cm- Ø24-1/2" x h. 11-3/4"



technical details p. 542

SUSPENSION



Kalatos Prisma bottom view / vista dal basso.

Kalatos is clearly inspired by the art of weaving baskets and cane sacks, a traditional domestic art that has been a part of human kind since prehistoric times. The collection is a high-tech take on this artisan craft, using Slamp's unique technopolymers; suspension and ceiling versions are available.

Il design di Kalatos è di chiara ispirazione all'arte dell'intreccio, espressione dell'artigianato artistico tradizionale che l'uomo porta con sé da quando, nella preistoria, intrecciava fibre vegetali per dar vita a cesti e canestri. Rivisitata in chiave high-tech, dato l'utilizzo dei tecnopolimeri di Slamp, la collezione si compone di una versione a sospensione e una plafoniera.

THE
ART OF
WEA
VING



accordéon

BY MARC SADLER



Accordéon White

 SUSPENSION
p.170

 WALL LAMP

 CEILING LAMP

 TABLE LAMP
p.324

 FLOOR LAMP



technical details p. 520

SUSPENSION

Accordéon Gold

Size / Dimensioni:
Ø57 x h. 20 cm - 22-1/4" x h. 7-3/4"



Accordéon Silver



The LED crown, in 2.700 or 3.000 kelvin according to choice, reaches up to 5.700 lumen and can be dimmed.

La corolla di LED - 2700 o 3000 Kelvin in base alle proprie necessità - raggiunge i 5700 lumen ed è completamente dimmerabile.

PLAY VIDEO

A SARTO RIAL



PROCESS

accordéon VERTICAL

BY MARC SADLER

technical details p. 520



Accordéon Vertical Gold



Accordéon Prisma detail.

Multiple suspensions are a perfect fit for restaurant and bars

Disposta in multipli diventa la perfetta illuminazione per bar e ristoranti.





HAND MOLDED

Lighting / Illuminazione:
1 x 10W E14/E12 LED Filament bulb Ømax 5 cm (2")

The collection blends design, fashion, artisan technique, and technology in a contemporary narrative.
Size: Ø11 x h. 30 cm - Ø4-1/4" x h. 11-3/4"

Che risvegli nella memoria il plissé di un tessuto o il mantice di una fisarmonica, questa collezione segna a pieno titolo l'apertura di un nuovo filone narrativo contemporaneo, in cui design, moda, artigianalità e tecnologia si tendono la mano in un liage indissolubile. Dimensione: Ø11 x h. 30 cm.

la lollona

BY LORENZA BOZZOLI

technical details p. 544

SUSPENSION



La Lollona 5 Pewter/White



La Lollona 5 Gradient

A soft finish that was inspired by modern fabric textures.

Inedita finitura ispirata alle texture tessili contemporanee.

SUSPENSION
p.186

WALL LAMP
p.400

CEILING LAMP

TABLE LAMP

FLOOR LAMP
p.480



The suspension's color and size can be customized by request to fit large scale installations.
 This page: a custom version of 3 different rings, white finish: Ø156 cm x h. 85 cm. Next Page: a custom version, gold finish Ø100 cm x h.170 cm.
 Customizzabile su richiesta – sia nei colori che nelle taglie - per progetti di larga scala. In questa pagina: una versione con 3 differenti livelli con finitura white di Ø156 cm x h. 85 cm. Nella pagina successiva una versione personalizzata in gold di Ø100 cm x h.170 cm



technical details p. 544

SUSPENSION



La Lollona 4 and La Lollo Linear 140 Gold

La Lollona arrives in superflat packaging weighing only 30 kg; easy to install, extraordinary to admire!
Imballo superflat e peso massimo di 30 kg: La Lollona è facile da installare, straordinaria da ammirare!



La Lollona 5 White

WEIGHT
LESS
ABUNDANCE

la lollo

LINEAR
BY LORENZA BOZZOLI

technical details p. 544

SUSPENSION



La Lollo Linear 140 - Gold

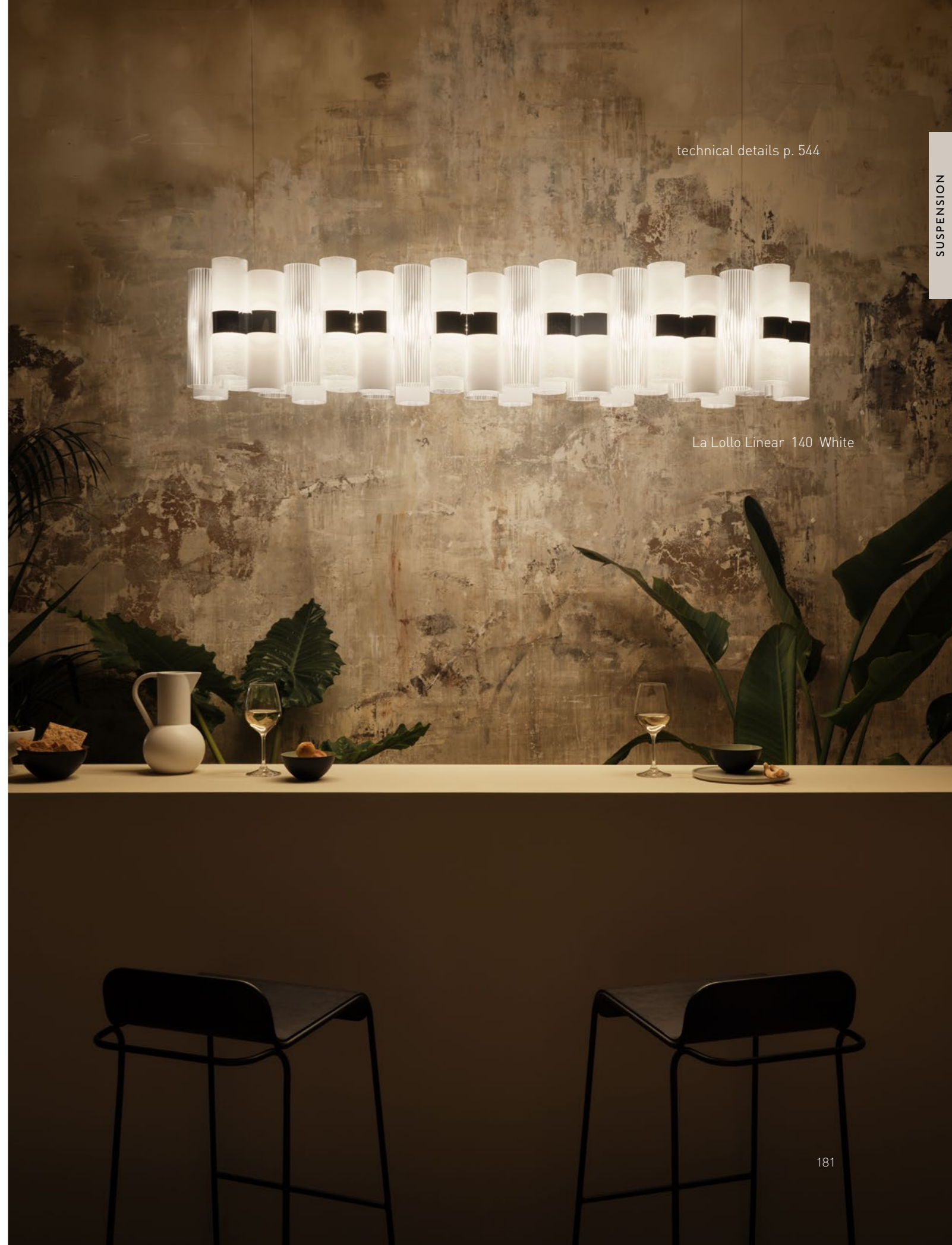

La Lollo Linear 140 White

SUSPENSION
p.186

WALL LAMP
p.400

CEILING LAMP

TABLE LAMP

FLOOR LAMP
p.480



La Lollo Linear 140 - Pewter/White

Lighting /Illuminazione:

Linear 100: 70W - 110-240Vac/24Vdc, 7.820 Lumen - 2700 Kelvin. Dimmable with: PWM, 0-10 or Potentiometer (110V Triac).

Linear 140: 110W - 110-240Vac/24Vdc, 12.420 Lumen - 2700 Kelvin. Dimmable with: PWM, 0-10 or Potentiometer (110V Triac).



La Lollo Linear 140 Gradient



La Lollo Linear 140 - White

Size / Dimensioni:

Linear 100: 93 x 28 x h.28 cm [36-1/4" x 11" x h. 11"]

Linear 140: 142 x 28 x h. 28 cm [55-1/4 x 11" x h.11"]

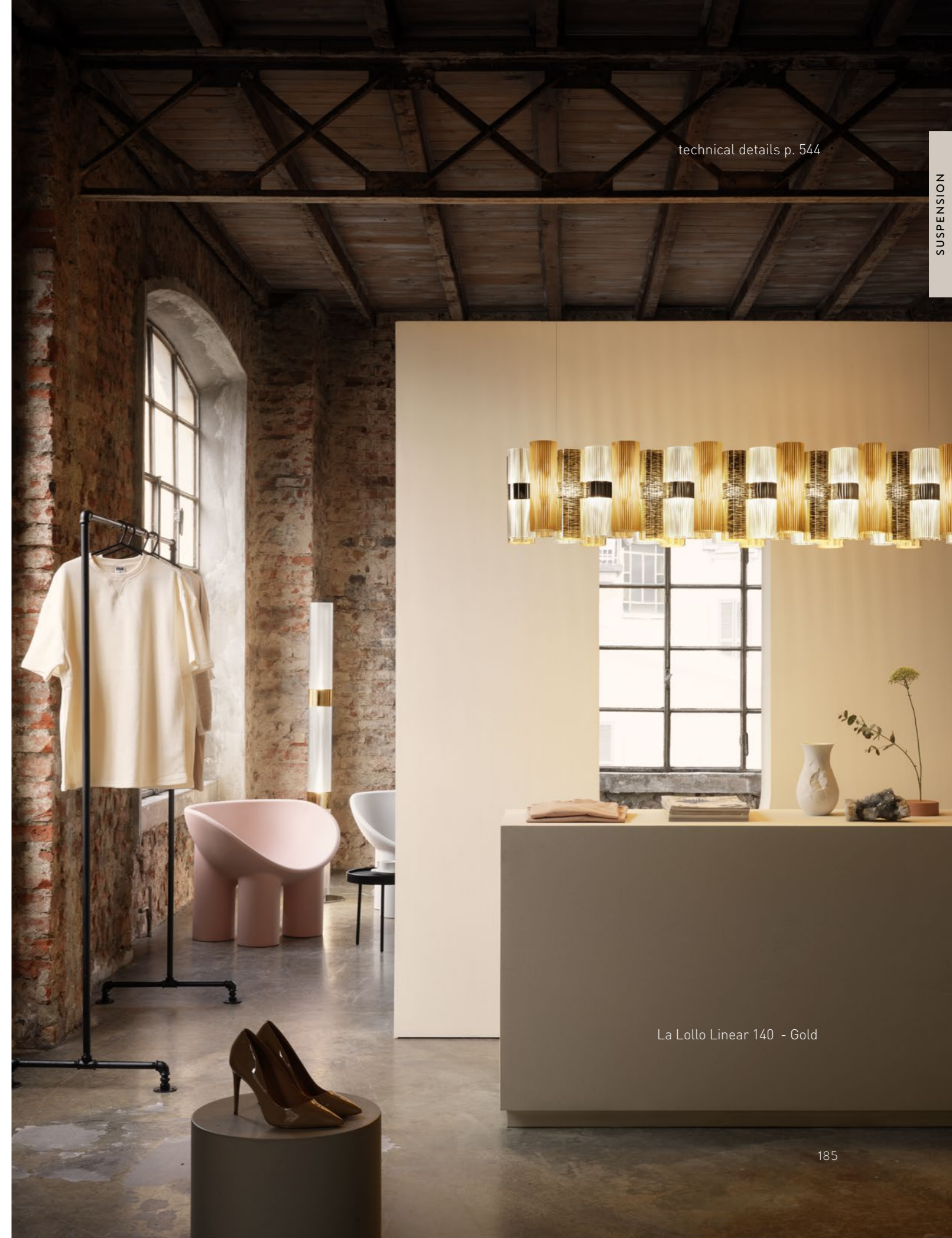

technical details p. 544

SUSPENSION

La Lollo Linear 140 - Gold

la lollo

BY LORENZA BOZZOLI



La Lollo Large Gold



SUSPENSION



WALL LAMP
p.400



CEILING LAMP



TABLE LAMP



FLOOR LAMP
p.480



technical details p. 543

La Lollo Medium Pewter/White



La Lollo Large White

The technopolymer cylinders alternate around a central LED illuminated ring.
 Una serie di cilindri di tecnopolimeri, infrangibili e leggeri sono disposti intorno ad un anello di luce a LED.



La Lollo XL Pewter

Gradient finish detail.



Gold finish detail.

Diameter and number of rings can be personalized. Pictured: a custom version of La Lollo gradient of Ø160 cm x h. 35 cm.
Il diametro di La Lollo è personalizzabile in base alle esigenze, nella foto versione custom gradient di Ø160 cm x h. 35 cm.

veli

FOLIAGE
BY ADRIANO RACHELE

technical details p. 557



SUSPENSION

Size / Dimensioni:
L: Ø55 cm x h. 45 cm Ø21
1/2" x h. 17-1/2"
M: Ø45 cm x h. 35 cm
Ø17-1/2" x h. 13-3/4"

SUSPENSION

WALL LAMP
p.418

CEILING LAMP
p.294

TABLE LAMP
p.376

FLOOR LAMP



Lighting / Illuminazione: L: 4 x12W LED Filament Bulb E27/E26 - M: 2 x12W LED Filament Bulb E27/E26

Available with red wrapped wire or transparent wire.
Disponibile sia con cavo di tessuto rosso calzato che trasparente.

an ODE



to
NATURE

veli

COUTURE
BY ADRIANO RACHELE



Veli Couture with red wrapped wire

technical details p. 556

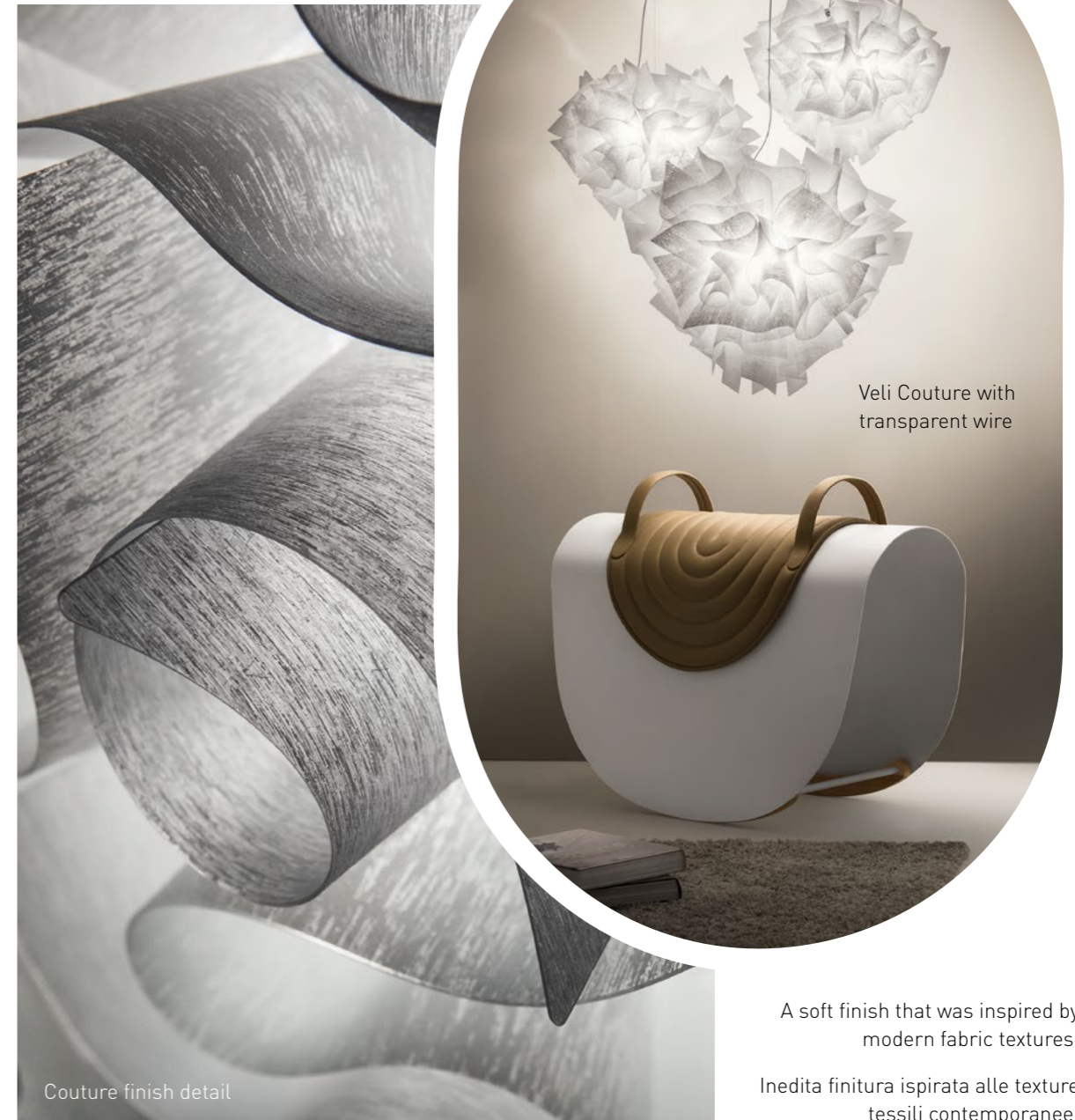

Couture finish detail

Veli Couture with transparent wire

A soft finish that was inspired by modern fabric textures.
Inedita finitura ispirata alle texture tessili contemporanee.

- 
 SUSPENSION
p.198
- 
 WALL LAMP
p.420
- 
 CEILING LAMP
p.296
- 
 TABLE LAMP
p.378
- 
 FLOOR LAMP

veli

MINI
COUTURE
BY ADRIANO RACHELE

technical details p. 555

SUSPENSION



Veli Mini Trio



Veli Mini Quartet



Veli Mini Single



A red wire brings the lamp a touch of irony (but can be replaced with a transparent one on request).
The magnetic hanging system facilitates installation and maintenance.

Il cavo rosso calzato aggiunge un pizzico di ironia (su richiesta può essere sostituito
con cavo trasparente). L'attacco magnetico facilita installazione e manutenzione.



PLAY VIDEO

veli

PRISMA

BY ADRIANO RACHELE

technical details p. 555



Lighting /Illuminazione:
 M: 2 x 12W LED Filament Bulb E27/E26
 L: 4 x 12W LED Filament Bulb E27/E26.
 Integrated magnetic system / Con attacco magnetico.



Prisma finish detail

Size / Dimensioni:
 L: Ø60 cm x h. 50 cm
 Ø23-3/4" x h. 19-3/4"
 M: Ø42 cm x h. 36 cm
 Ø16-1/2" x h. 14-1/4"

- 
 SUSPENSION
- 
 WALL LAMP
 p.422
- 
 CEILING LAMP
 p.298
- 
 TABLE LAMP
- 
 FLOOR LAMP

veli

GOLD, SILVER
& COPPER
BY ADRIANO RACHELE

technical details p. 555



Veli Copper

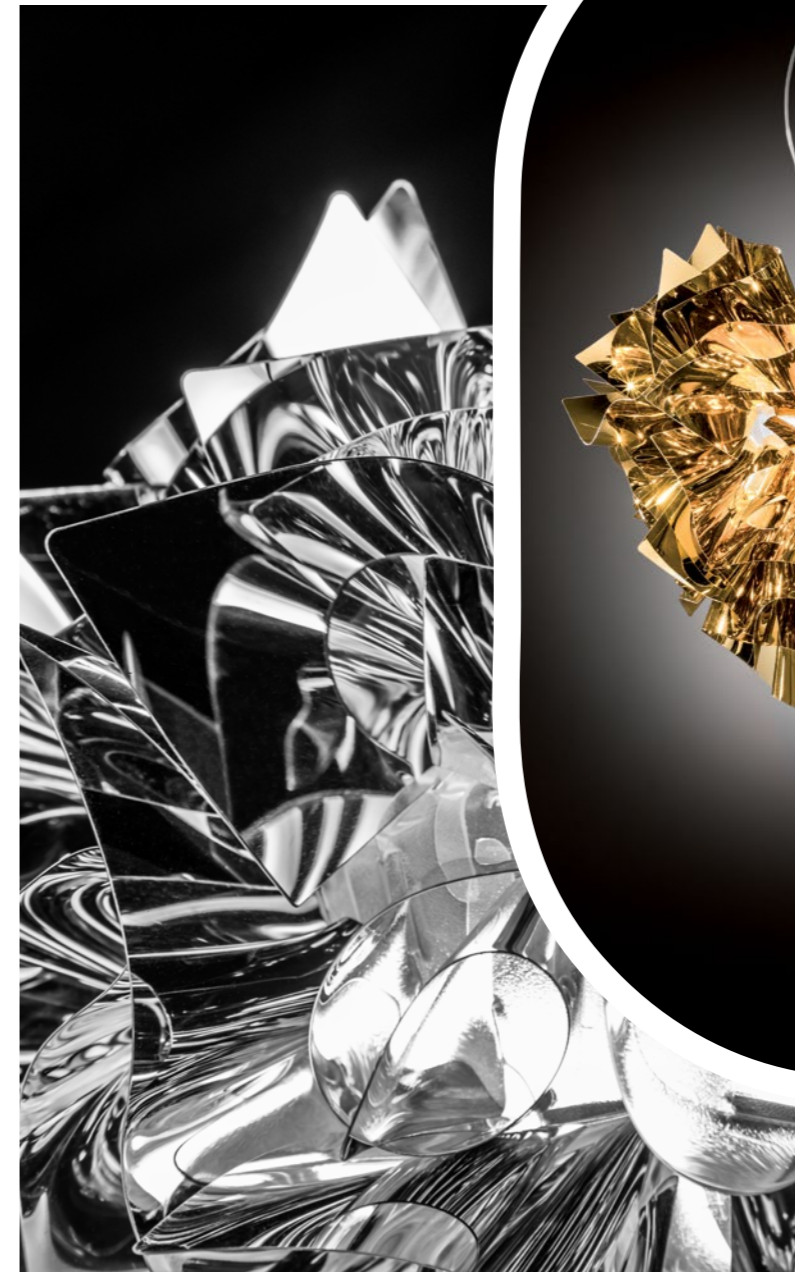

Veli Silver detail



Veli Gold

Handcrafted of noble, luxurious
technopolymers.
Realizzate a mano con tecnopolimeri
nobili, lucenti e preziosi..

- 
 SUSPENSION
- 
 WALL LAMP
p.424
- 
 CEILING LAMP
p.300
- 
 TABLE LAMP
- 
 FLOOR LAMP

veli

BY ADRIANO RACHELE



Veli M Opal

technical details p. 555

Veli L Opal

SUSPENSION

-  SUSPENSION
-  WALL LAMP
p.426
-  CEILING LAMP
p.302
-  TABLE LAMP
p.378
-  FLOOR LAMP



Plum finish detail

Veli Charcoal

Lighting / Illuminazione:
 L: 4x12W LED Filament Bulb E27/E26
 M: 2x12W LED Filament Bulb E27/E26

Integrated magnetic system.
 Dotata di attacco magnetico.

veli 7

BY ADRIANO RACHELE

technical details p. 556



Lighting /Illuminazione: 9 x 12W LED Filament Bulb E27/E26.
Electric wire 400 cm /156"- Cavo elettrico di 400 cm.

- 
 SUSPENSION
p.204
- 
 WALL LAMP
p.426
- 
 CEILING LAMP
p.302
- 
 TABLE LAMP
p.378
- 
 FLOOR LAMP

hanami

BY ADRIANO RACHELE



Hanami Large

- 
 SUSPENSION
- 
 WALL LAMP
 p.450
- 
 CEILING LAMP
 p.306
- 
 TABLE LAMP
- 
 FLOOR LAMP



CHERRY BLOSSOMS

Lighting / Illuminazione:
 L: 10 X 5W G9 LED Bulbs
 M: 5 X 5W G9 LED Bulbs



Flowers folded by hand, each made from Lentiflex®, a noble, unbreakable material that shines like a precious stone.
Fiori plissettati a mano in Lentiflex®, materiale nobile e infrangibile con riflessi di un diamante.



Size / Dimensioni:
L: 96 x 60 x h.26 cm
37-3/4" x 23-1/2" x h.10-1/4"
M: 53 x 35 x h.25 cm
20-3/4" x 13-3/4" x h.9-3/4"

flora

BY ZANINI DE ZANINE

technical details p. 538



Flora Large Gold



Flora Silver bottom view



idea
BRASIL IDSA
'14
AWARD

60 petals surround a hand-finished sphere illuminated from its core.
La sfera luminosa è circondata da 60 petali ed è satinata a mano.

- 
 SUSPENSION
- 
 WALL LAMP
- 
 CEILING LAMP
- 
 TABLE LAMP
- 
 FLOOR LAMP
 p.500

fabula

BY COSTANTINO MOROSIN



Fabula Large

- 
 SUSPENSION
- 
 WALL LAMP
 p.456
- 
 CEILING LAMP
 p.312
- 
 TABLE LAMP
- 
 FLOOR LAMP

technical details p. 535

SUSPENSION



Handmade with Lentiflex®, Fabula appears to be a long, silky piece of fabric wound around itself.

Realizzata a mano concatenando elementi di Lentiflex®, Fabula ricorda una lunga e soffice fascia di seta avvolta su se stessa.



LE GRAND ceremony

BY BRUNO RAINALDI

technical details p. 529

SUSPENSION



CUSTOMIZABLE

Technical and lighting details for custom versions will be adapted to the specific project.

I dettagli illuminotecnici delle versioni customizzate vengono adattati al progetto specifico.





Le Grand Ceremony with black matte ceiling structure.
Le Grand Ceremony con struttura a soffitto nera opaca.

A close-up of printed and richly engraved Cristalflex® decorative elements.
Dettaglio degli elementi decorativi in Cristalflex®, stampati e arricchiti da incisioni

A lowered or false ceiling is necessary to connect the spotlight's electrical elements
contro soffitto o cielino necessario per collegamento elettrico degli spot

spotlights
struttura
struttura
decorative elements
elementi decorativi

Twenty-one spotlights encircle a customizable iron ring (finishing to be determined per project), inserted in the lowered or false ceiling, illuminating the opulent Cristalflex® layers draped below.
21 faretti vengono installati in un contro soffitto seguendo la struttura in ferro circolare (finitura customizzabile in base alla scelta del cliente) ad illuminare gli opulenti drappi in Cristalflex®

Size/Dimensioni: Ø213 x h. 250 cm (Ø83" x h. 97-1/2")

ceremony

BY BRUNO RAINALDI

technical details p. 529



Acquisition Gala Dinner Maxxi Museo Internazionale delle arti del XXI secolo, Rome. Pictured: Ceremony Large.

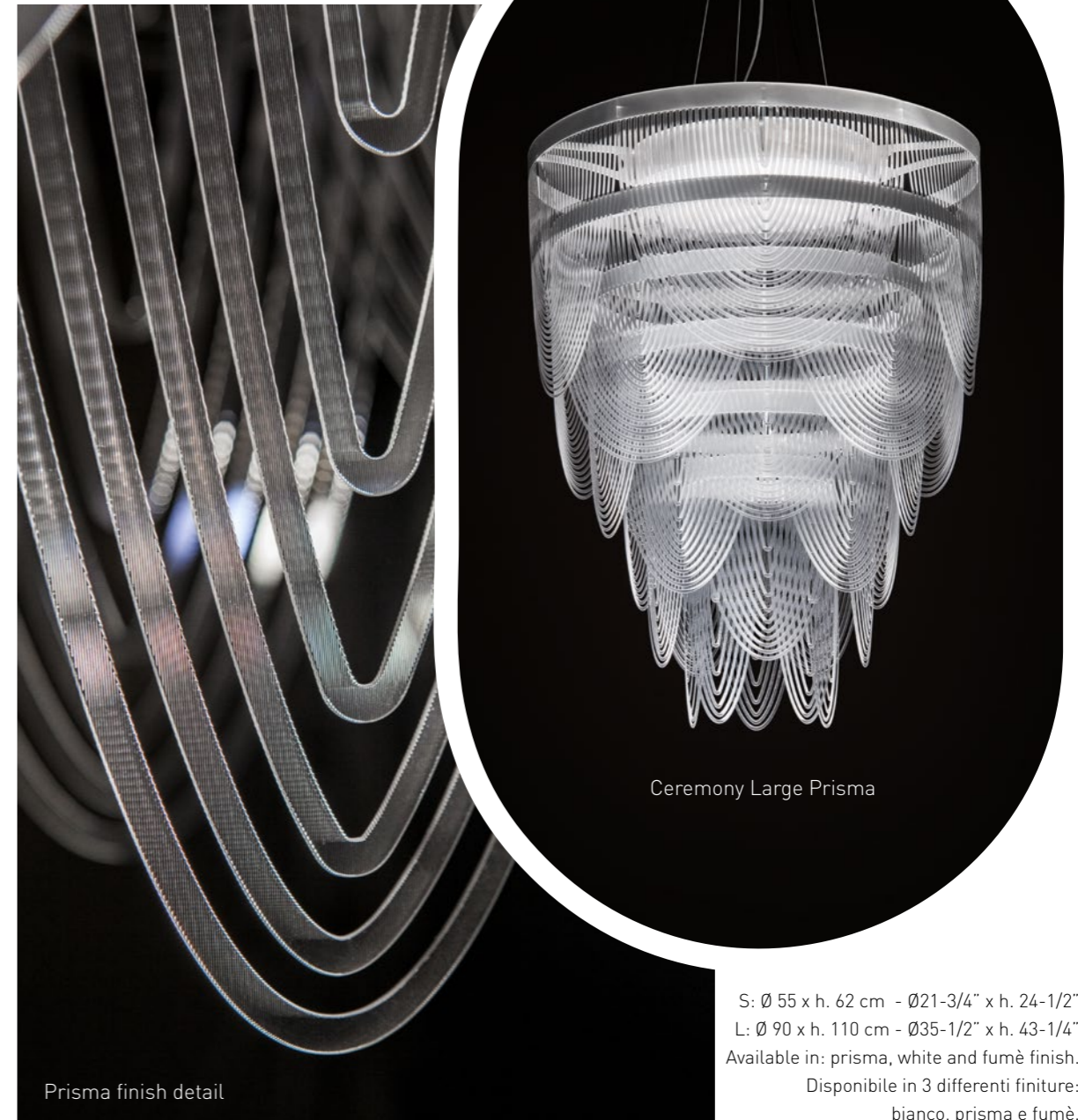

Ceremony Large Prisma

Prisma finish detail

S: Ø 55 x h. 62 cm - Ø21-3/4" x h. 24-1/2"
 L: Ø 90 x h. 110 cm - Ø35-1/2" x h. 43-1/4"
 Available in: prisma, white and fumè finish.
 Disponibile in 3 differenti finiture:
 bianco, prisma e fumè.



SUSPENSION

WALL LAMP

CEILING LAMP

TABLE LAMP

FLOOR LAMP

lilibet

BY NIGEL COATES

technical details p. 547

Lilibet Gold

SUSPENSION



Lilibet Transparent

Lighting / Illuminazione: 1 x 12W E27/E26 LED Filament bulb

Size / Dimensioni: Ø66 x h.47 cm - Ø26" x h.18"

56 Schöler crystals - Con 56 cristalli Schöler - Available in 7 finishes - Disponibili in 7 finiture.



SUSPENSION



WALL LAMP
p.470



CEILING LAMP



TABLE LAMP



FLOOR LAMP



goccia

BY STEFANO PAPI



Goccia Prisma

Available in 7 finishes - Disponibili in 7 finiture.
Lighting / Illuminazione: 1 x 12W E27/E26 LED Filament bulb

-  SUSPENSION
-  WALL LAMP
-  CEILING LAMP
-  TABLE LAMP
-  FLOOR LAMP



Goccia Fire

DROPS OF LIGHT

woody

BY LUCA MAZZA



Lighting / Illuminazione:
1 x 12W E27/E26
LED Filament bulb

- 
SUSPENSION
- 
WALL LAMP
- 
CEILING LAMP
- 
TABLE LAMP
- 
FLOOR LAMP

drusa

BY ADRIANO RACHELE

technical details p. 534



Drusa Velvet at Stella Island Luxury Suites and Spa Creta, Greece



Velvet finish detail



Drusa White

Lighting /Illuminazione:
4 x 12W E27/E26
LED Filament bulb

Dimensions/Dimensione
Ø60 x h. 25 cm
Ø23-1/2" x h. 9-3/4"

- 
 SUSPENSION
- 
 WALL LAMP
p.458
- 
 CEILING LAMP
p.282
- 
 TABLE LAMP
- 
 FLOOR LAMP

cactus

BY ADRIANO RACHELE



Lighting / Illuminazione: 1 x 12W E27/E26 LED Filament bulb
Size / Dimensioni: Ø50 x h. 27 cm - Ø19-3/4" x h. 10-3/4"



SUSPENSION



WALL LAMP



CEILING LAMP



TABLE LAMP
p.388



FLOOR LAMP
p.496



technical details p. 528

atlante

BY NIGEL COATES

technical details p. 523



Lighting / Illuminazione:
8 x 15W max IBC/C E14/E12 bulbs
Size / Dimensioni: Ø51 x h. 38 cm
Ø20" x h. 15"

- 
 SUSPENSION
- 
 WALL LAMP
- 
 CEILING LAMP
- 
 TABLE LAMP
- 
 FLOOR LAMP
 p.516

supermorgana

BY STEFANO PAPI



-  SUSPENSION
-  WALL LAMP
-  CEILING LAMP
-  TABLE LAMP
-  FLOOR LAMP



MAGICAL
REFRACTIONS

ginetta

BY NIGEL COATES

technical details p. 539



A soft finish that was inspired by modern fabric textures.

Inedita finitura ispirata alle texture tessili contemporanee.



SUSPENSION

WALL LAMP

CEILING LAMP

TABLE LAMP

FLOOR LAMP

luis

BY ADRIANO RACHELE



Inspired by the smallest bird in the world, Luis enchants with plays of shadow and reflection, and branches that envelop the light source.
Ispirata all'uccellino più piccolo del mondo Luis incanta per i suoi giochi di ombre e riflessi creati dai tanti rami che avvolgono la fonte luminosa.



PLAYS



OF SHADOWS

fiorella

BY NIGEL COATES



NEVER ENDING
BOUQUET

Fiorella Mini Gold



SUSPENSION



WALL LAMP
p.464



CEILING LAMP



TABLE LAMP
p.380



FLOOR LAMP



technical details p. 536

Fiorella White

SUSPENSION

liza

BY ELISA GIOVANNONI



Size/Dimensioni: Ø45 x 33 cm - Ø17-3/4" x h 12-3/4"



SUSPENSION



WALL LAMP



CEILING LAMP



TABLE LAMP

p.368



FLOOR LAMP

technical details p. 547

SUSPENSION



medusa

BY NIGEL COATES



Medusa Pewter



Restaurant 1718
Deidesheim, Germany

Size / Dimensioni:
Ø83 x h. 61 cm
Ø33-3/4" x h. 24"

- 
SUSPENSION
- 
WALL LAMP
p.468
- 
CEILING LAMP
- 
TABLE LAMP
- 
FLOOR LAMP

atmosfera

BY LORENZA BOZZOLI



Atmosfera Gold

Size /Dimensioni:
 Ø30 x h 44,5cm
 Ø11 3/4" x h. 17 1/4"

- 
 SUSPENSION
- 
 WALL LAMP
- 
 CEILING LAMP
- 
 TABLE LAMP
 p.386
- 
 FLOOR LAMP



technical details p. 523

SUSPENSION

Atmosfera Gold

Mariano Di Vaio
 NOHOW head quarter

gemmy

BY RAGNISCO, SPALLETTA,
CROCE, WIJFFELS



INSPIRED BY DESERT

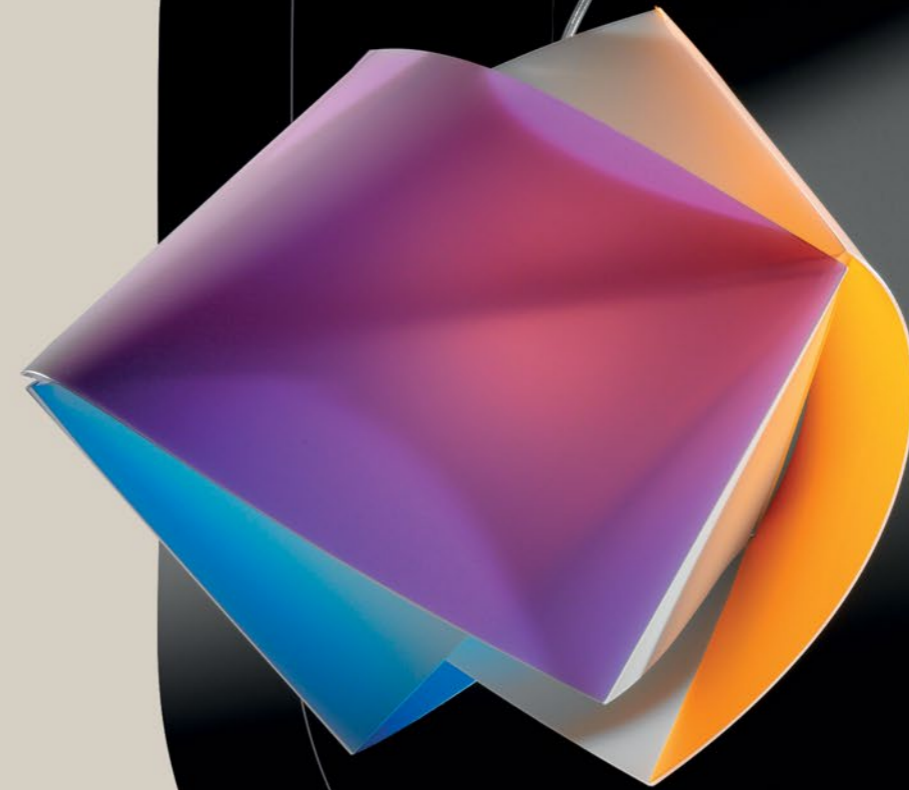

Gemmy Arlecchino

GEMS



SUSPENSION



WALL LAMP



CEILING LAMP



TABLE LAMP
p.392



FLOOR LAMP

gemmy PRISMA

BY RAGNISCO, SPALLETTA,
CROCE, WIJFFELS

technical details p. 538



- 
 SUSPENSION
- 
 WALL LAMP
- 
 CEILING LAMP
- 
 TABLE LAMP
 p.394
- 
 FLOOR LAMP

CEILING

LAMPS

SLAMP:

odeon

BY LORENZA BOZZOLI



- SUSPENSION
- WALL LAMP
- CEILING LAMP
- TABLE LAMP
- FLOOR LAMP

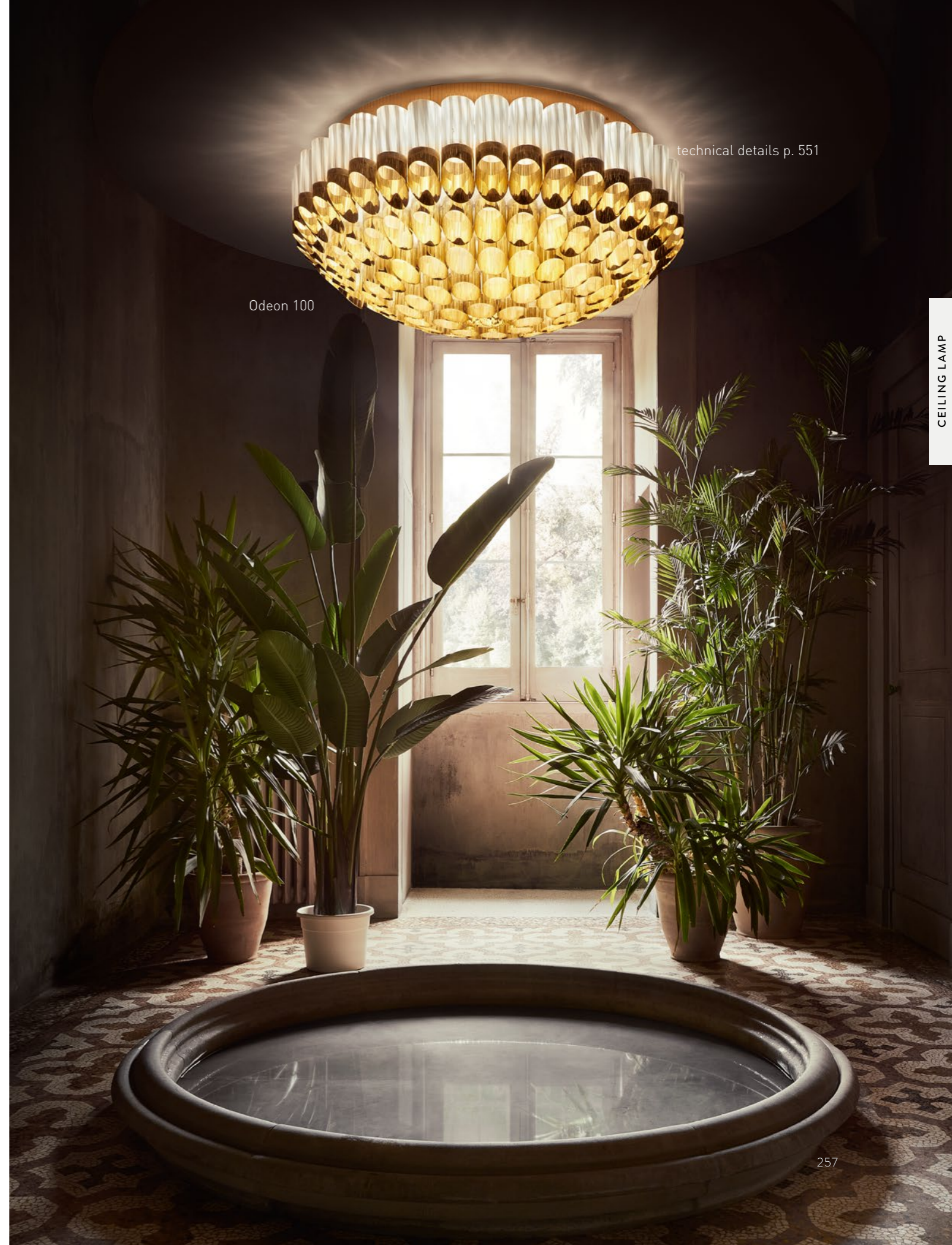



Lighting /Illuminazione:

Odeon 100: 12 x12W E27/E26 LED Filament bulbs + 1 x 6,5W E27/E26 Spot LED, PAR 38 (Ø12,2 cm x h.13 cm)

Odeon 65: 6 x12W E27/E26 LED Filament bulbs + 1 x 6,5W E27/E26 Spot LED, PAR 38 (Ø12,2 cm x h.13 cm)



Odeon 65

Dimensions /Dimensione:

Odeon 100: Ø102 x h.42 cm

Ø39-3/4" x h. 16-1/2"

Odeon 65: Ø65 x h.33 cm

Ø25-1/4" x h. 13"



CUSTOMIZABLE DIAMETER

Odeon can be customized to fit any project, with up to a 210 cm diameter and adaptable technical settings for specific installations.

Odeon può essere personalizzata per adattarsi a qualsiasi progetto, fino a 210 cm di diametro. Le specifiche illuminotecniche sono adattate in base alle specifiche delle installazioni.



technical details p. 551

Odeon 100

clizia

MAMA NON MAMA
BY ADRIANO RACHELE

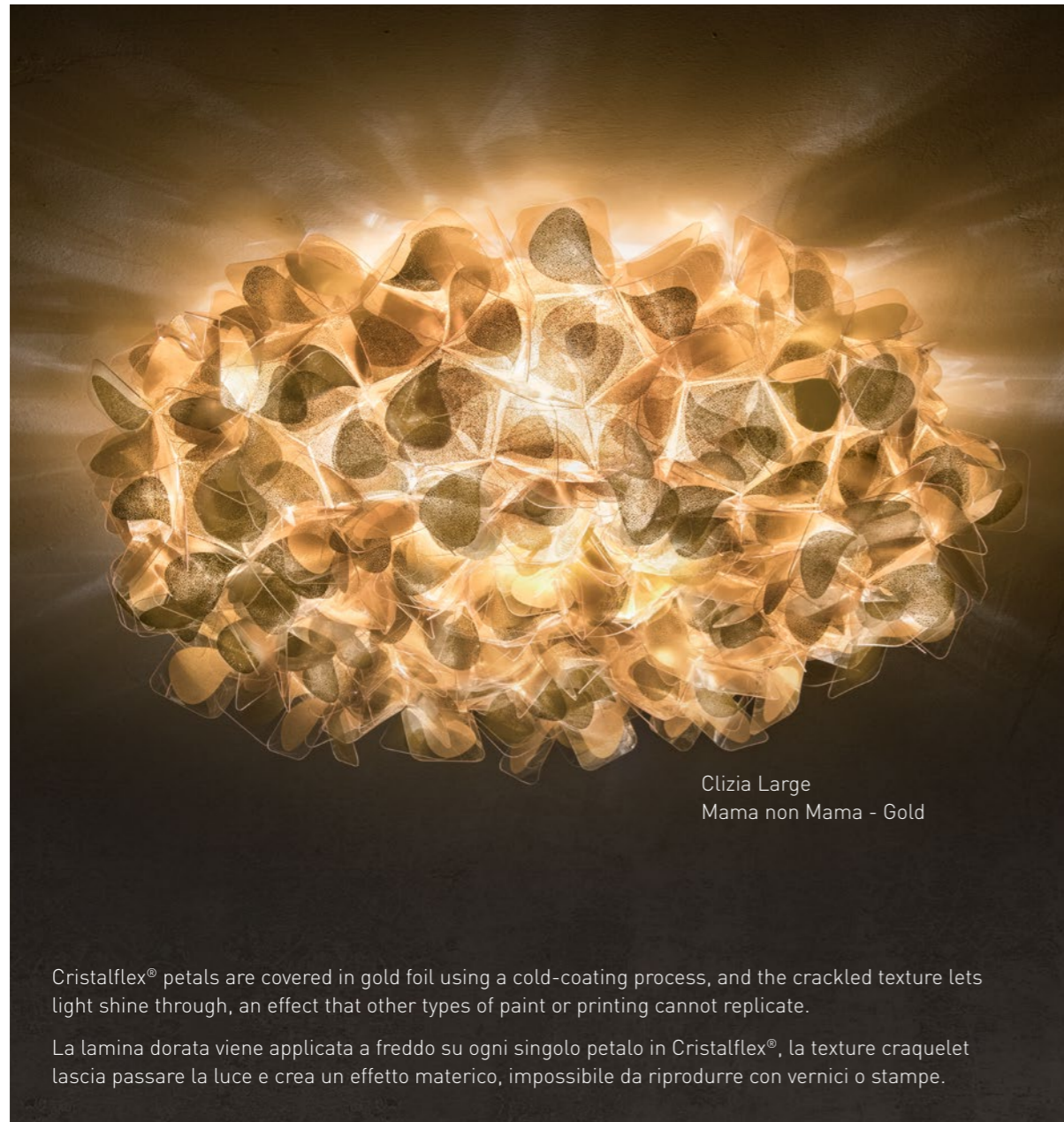

Clizia Large
Mama non Mama - Gold

Cristalflex® petals are covered in gold foil using a cold-coating process, and the crackled texture lets light shine through, an effect that other types of paint or printing cannot replicate.

La lamina dorata viene applicata a freddo su ogni singolo petalo in Cristalflex®, la texture craquelé lascia passare la luce e crea un effetto materico, impossibile da riprodurre con vernici o stampe.



technical details p. 531

Clizia Large
Mama non Mama - Black

CEILING LAMP



Clizia Large Ceiling and Clizia Mini Wall

Lighting / Illuminazione:

Ceiling/Wall Available in 3 sizes with magnetic hanging system - Disponibile in 3 misure con attacco magnetico.

L: 3 x 12W E26/E27 - M: 2 x 12W E26/E27 - Mini: 2 x 6W E12/E14 LED Filament Bulbs.



Gold craquelé detail

Available in 3 sizes.
Disponibile in 3 misure.

L: Ø78 x h.25 cm - Ø30-3/4" x h.9-3/4"

M: Ø53 x h.20 cm - Ø20-3/4" x h.8"

Mini: Ø32 x h.15 cm - Ø12-1/2" x h.5-3/4"

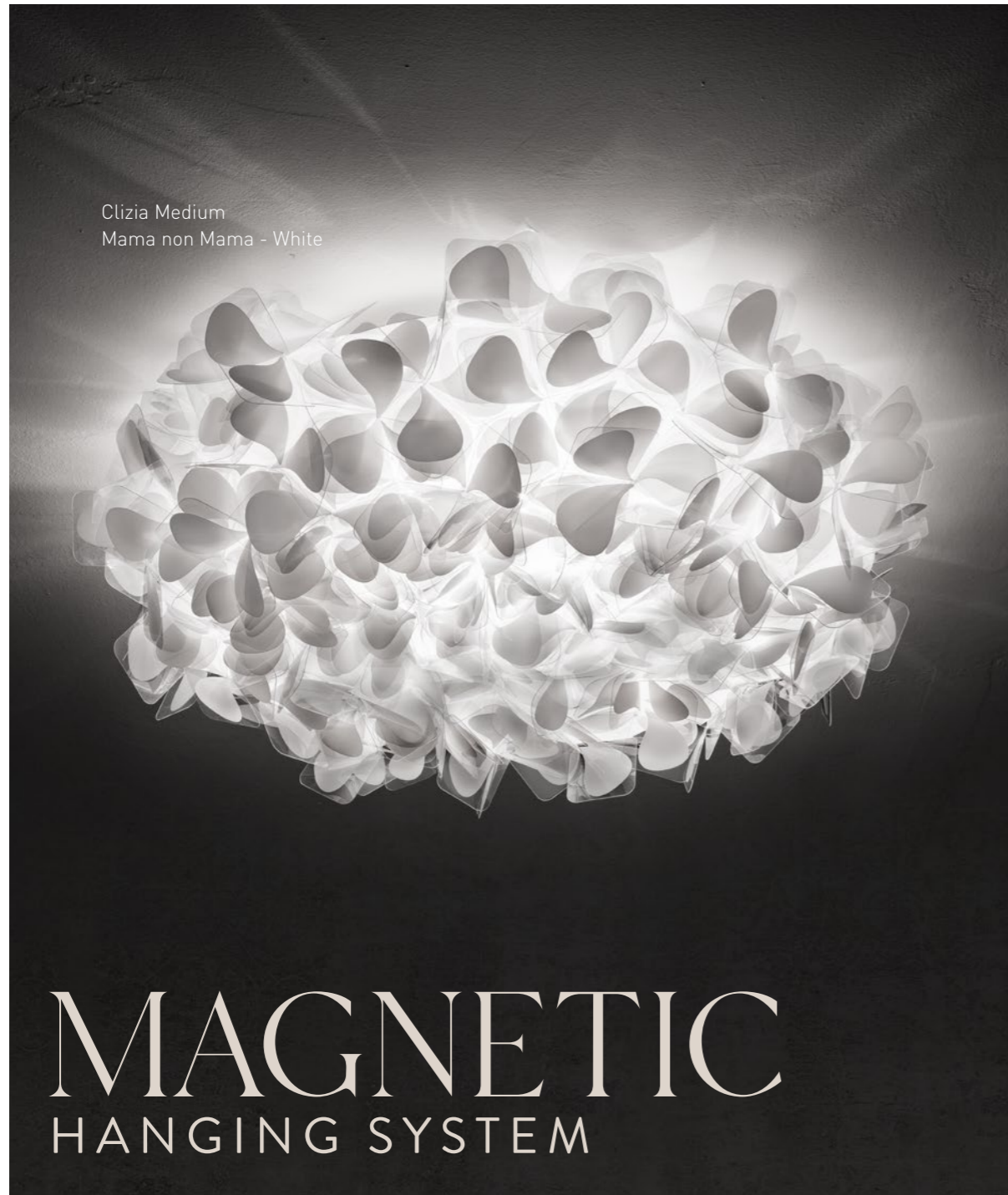

Clizia Medium
Mama non Mama - White

MAGNETIC HANGING SYSTEM

The magnetic hanging system allows the decorative shade to be removed and replaced with a simple click, facilitating installation and maintenance.

Grazie all'attacco magnetico, il decoro si stacca dalla fonte luminosa con un semplice click per facilitare l'installazione e la pulizia del diffusore.

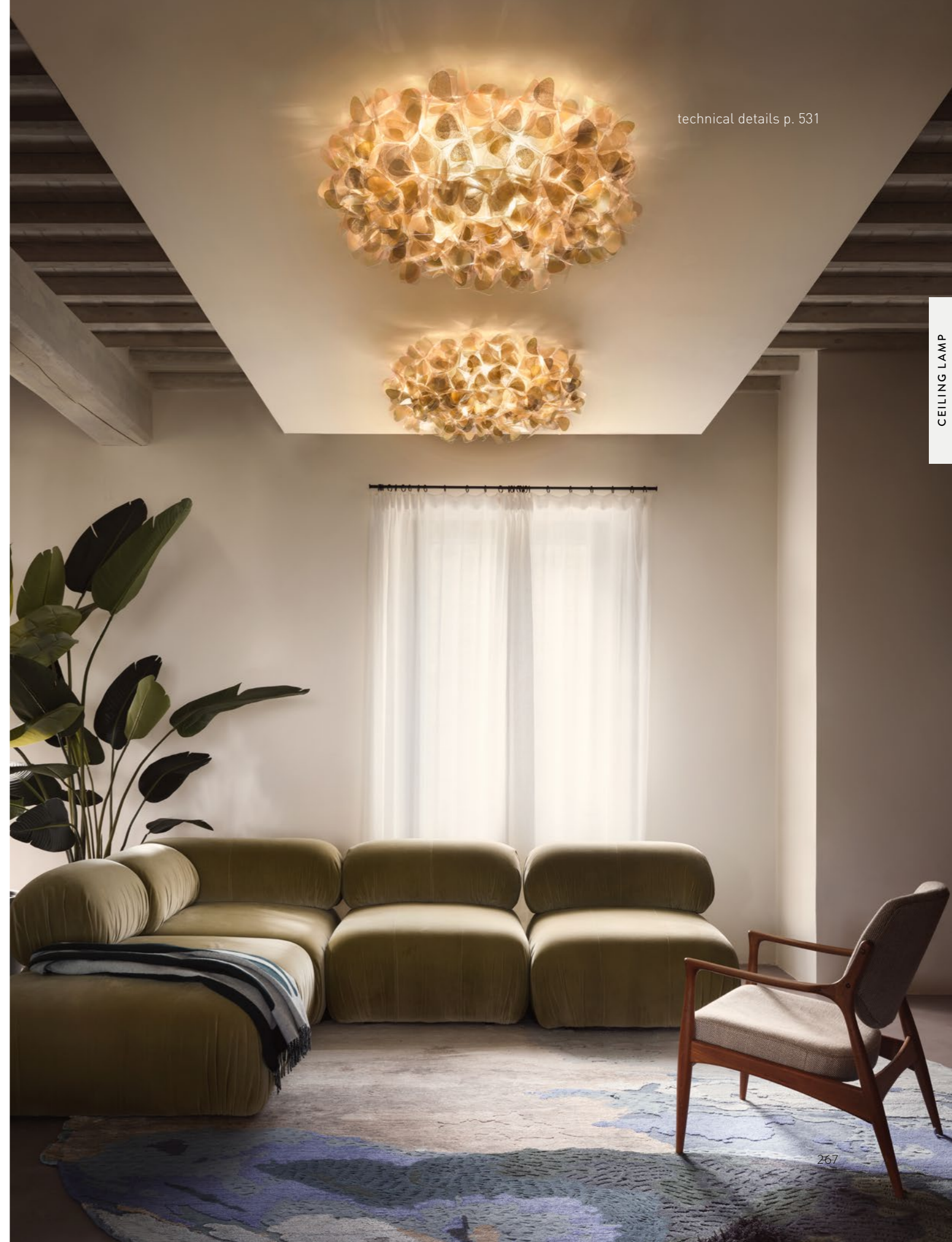

technical details p. 531

CEILING LAMP

clizia

FUMÉ
BY ADRIANO RACHELE

technical details p. 531



Clizia Large Fumè

L: Ø78 x h.25 cm - Ø30-3/4" x h.9-3/4"
 M: Ø53 x h.20 cm - Ø20-3/4" x h.8"
 Mini: Ø32 x h.15 cm - Ø12-1/2" x h.5-3/4"



 SUSPENSION
 p.144

 WALL LAMP
 p.412

 CEILING LAMP

 TABLE LAMP
 p.354

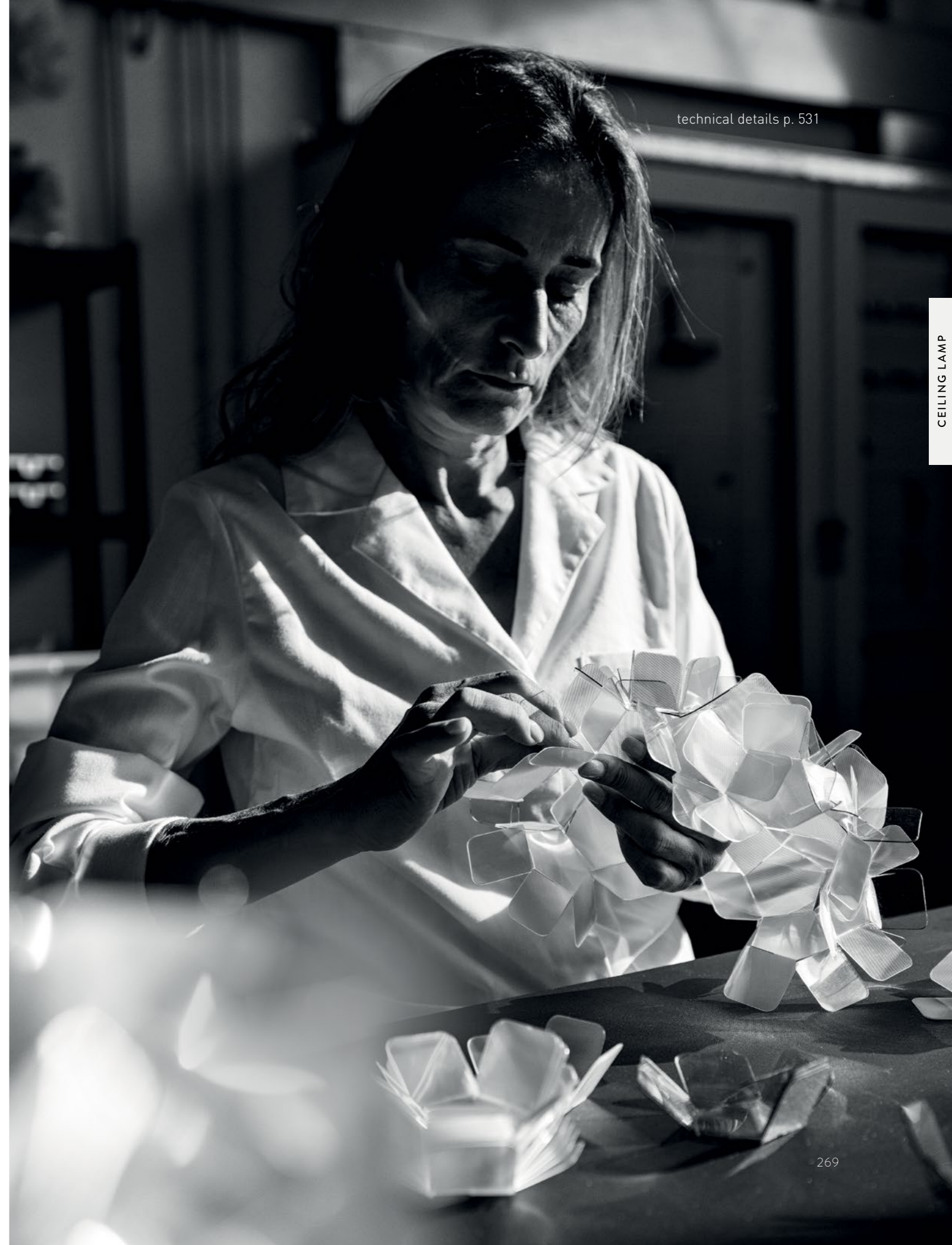
 FLOOR LAMP



clizia

PIXEL
BY ADRIANO RACHELE

technical details p. 531



Clizia Medium Pixel

Clizia Large Pixel



Clizia Large Pixel

Clizia is covered in pixels; a high-tech pattern meets soft tones that enhance the lamp's lush volume. A subtle dusting of white helps to evenly diffuse light without any glare.

Clizia si tinge di Pixel: una decorazione high-tech in tonalità tenui che si dipana sul volume rigoglioso della lampada. La spolverata di bianco all'interno del decoro contribuisce a diffondere uniformemente la luce e evitare l'abbagliamento.

clizia

BY ADRIANO RACHELE

technical details p. 531



Clizia Large White

MAGNETIC
HANGING SYSTEM



Purple finish detail

Clizia Large White

Lighting / Illuminazione:
L: 3 x 12W E27/ E26
M 2 x 12W E27 /E26
Mini: 2 x 6W E14/E12
LED Filament Bulbs



SUSPENSION
p.150



WALL LAMP
p.416



CEILING LAMP



TABLE LAMP
p.360



FLOOR LAMP



Clizia Large Orange

High-quality, non-toxic ink is used for screen printing that creates contemporary colors and textures.

Il processo di colorazione è ottenuto mediante stampa serigrafica con inchiostri di alta qualità e atossici per creare trend cromatici dal gusto contemporaneo.



HAND
MADE
FOLDING

la vie

BY ADRIANO RACHELE

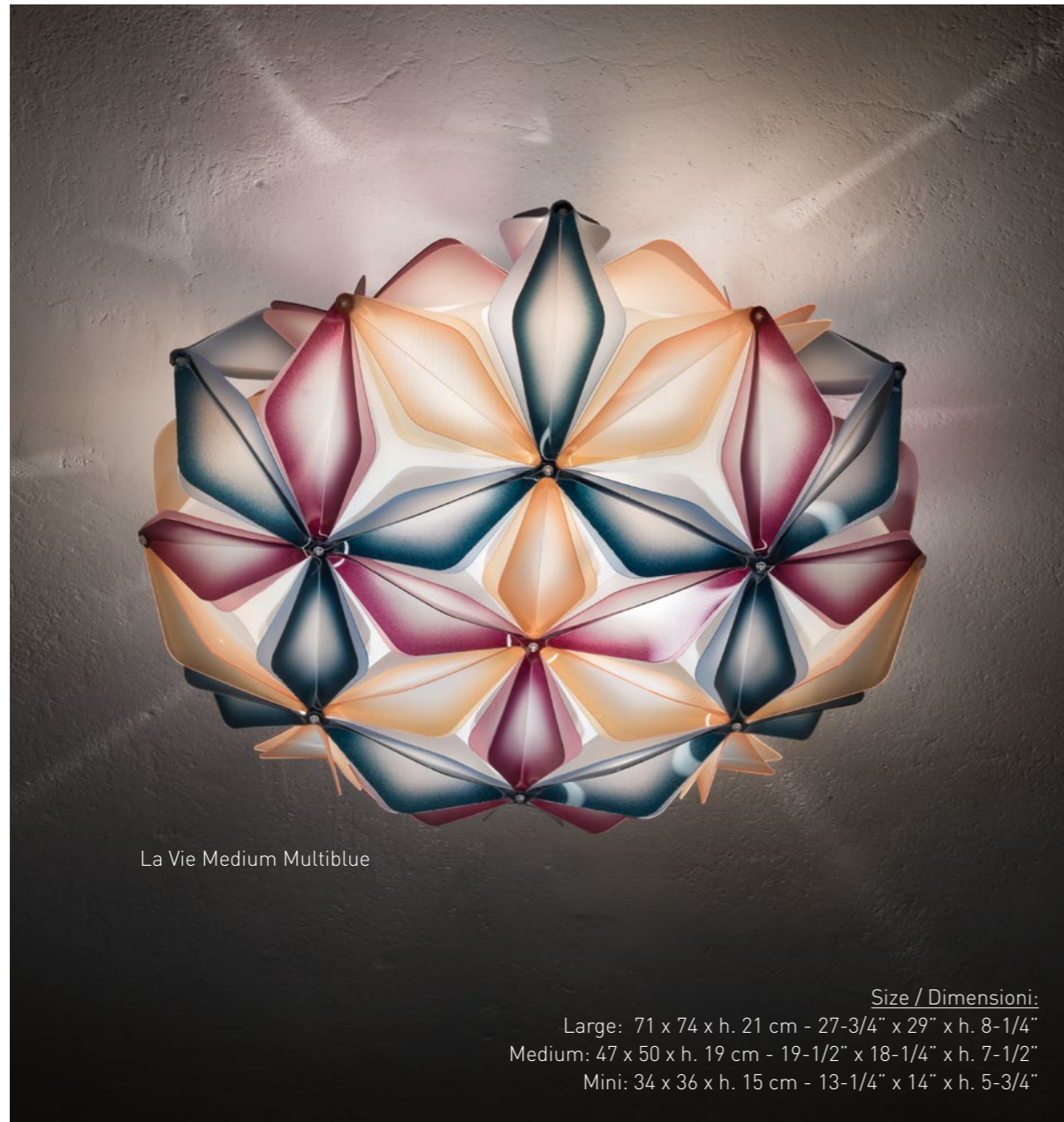

La Vie Medium Multiblue

Size / Dimensioni:

Large: 71 x 74 x h. 21 cm - 27-3/4" x 29" x h. 8-1/4"
Medium: 47 x 50 x h. 19 cm - 19-1/2" x 18-1/4" x h. 7-1/2"
Mini: 34 x 36 x h. 15 cm - 13-1/4" x 14" x h. 5-3/4"



SUSPENSION



WALL LAMP
p.428



CEILING LAMP



TABLE LAMP



FLOOR LAMP



technical details p. 545

La Vie Large White

CEILING LAMP



La Vie Large White



La Vie Multigreen detail



La Vie Large Amber

Lighting / Illuminazione:
Large: 3 x 12W - E27/E26 LED Filament Bulbs ; Medium: 2 x 12W - E27/E26 LED Filament Bulbs
Mini: 2 x 6W E14/E12 LED Filament Bulbs



technical details p. 545

La Vie Large Blue

CEILING LAMP

drusa

BY ADRIANO RACHELE

technical details p. 534

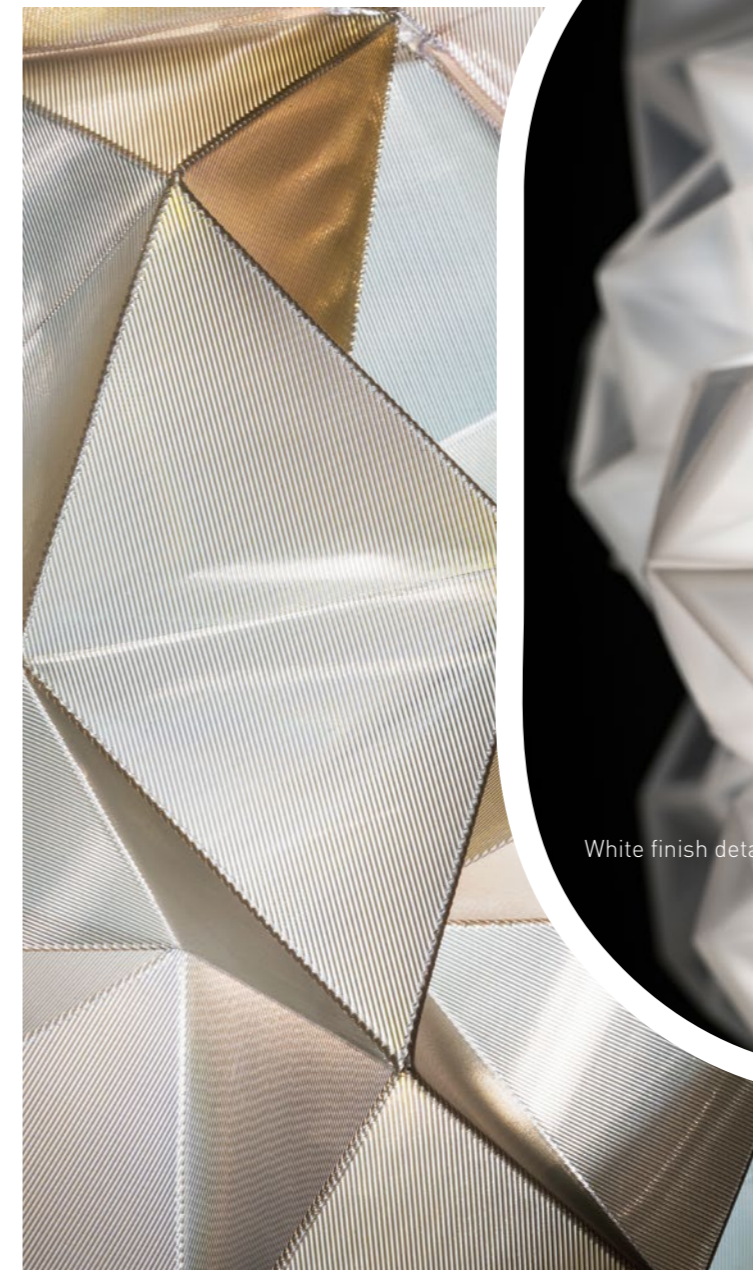

Drusa Velvet is made of printed Lentiflex®, making every iridescent, silky piece unique.
 La stampa di Drusa Velvet è realizzata su Lentiflex® e rende ogni prodotto unico, con una cromia iridescente e setosa.

- 
 SUSPENSION
 p.230
- 
 WALL LAMP
 p.458
- 
 CEILING LAMP
- 
 TABLE LAMP
- 
 FLOOR LAMP



Size / Dimensioni: Ø60 cm x 20 cm - Ø23-1/2" x h. 8"
Lighting / illuminazione: 4 x 12W E27/E26 LED Filament Bulbs

Drusa White

AN IRIDESCENT
GEODE



Drusa Velvet

kalatos

BY ELISA GIOVANNONI



Kalatos Prisma bottom view
Vista dal basso di Kalatos Prisma

-  SUSPENSION
p.160
-  WALL LAMP
-  CEILING LAMP
-  TABLE LAMP
-  FLOOR LAMP



technical details p. 542

Kalatos Prisma

CEILING LAMP



Size / Dimensioni: Ø63 x h. 30 cm - Ø24-1/2" x h. 11-3/4

HANDCRAFTED
WEAVING
VING



Kalatos Black/Gold



mida

BY ADRIANO RACHELE

technical details p. 548



Mida Medium Multicolor

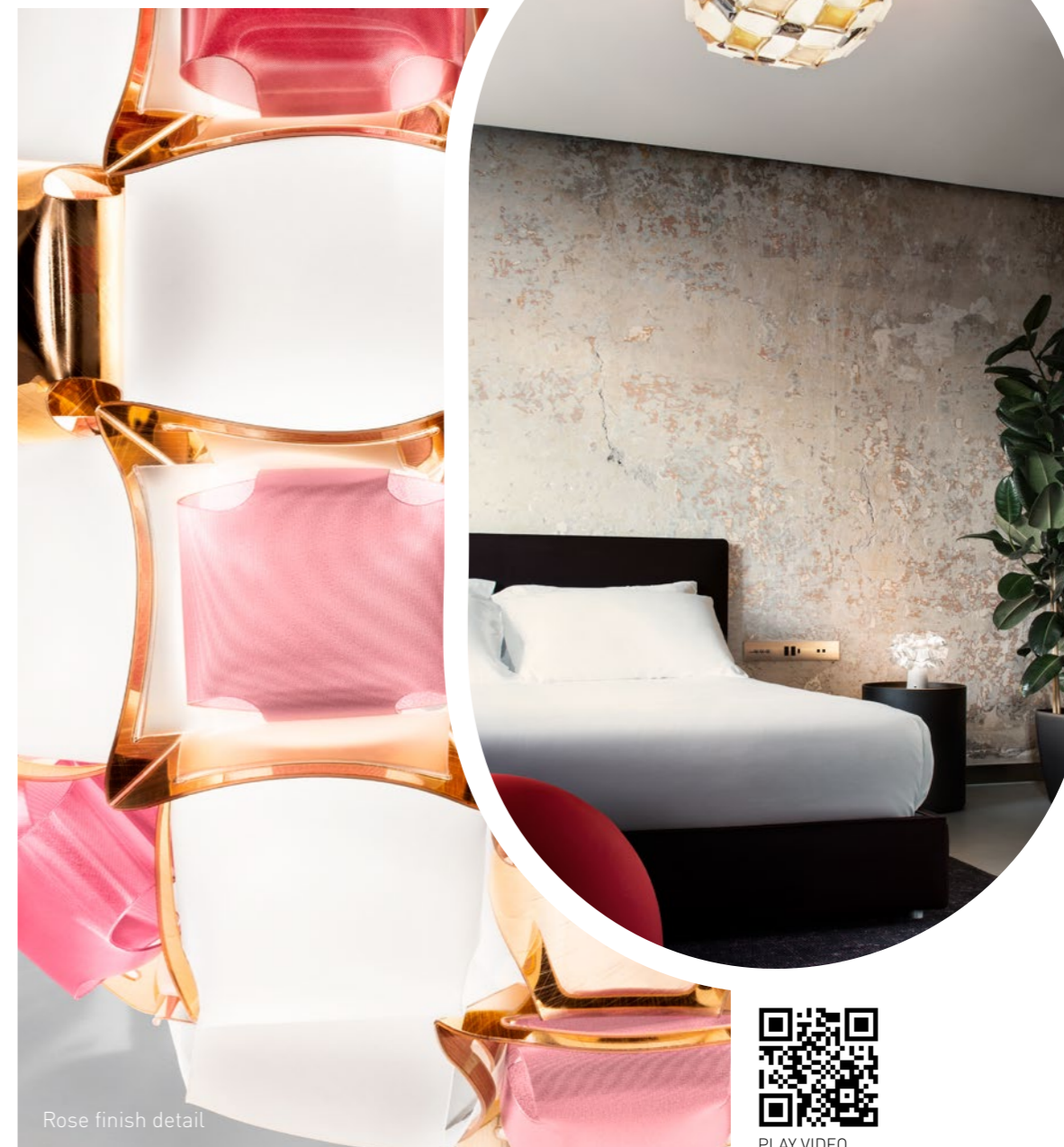

Rose finish detail



PLAY VIDEO

The gems are hand-mounted on a printed Opalflex® and Lentiflex® base.

La gemme sono incastonate su una struttura assemblata a mano realizzata con una combinazione di Opalflex® e Lentiflex® stampato.

- 
 SUSPENSION
- 
 WALL LAMP
 p.444
- 
 CEILING LAMP
- 
 TABLE LAMP
- 
 FLOOR LAMP



Mida Medium - Amber

LIKE A
JEWEL



Mida Medium - White/Platinum

veli

FOLIAGE
BY ADRIANO RACHELE



SUSPENSION
p.192

WALL LAMP
p.418

CEILING LAMP

TABLE LAMP
p.376



FLOOR LAMP



veli

COUTURE
BY ADRIANO RACHELE

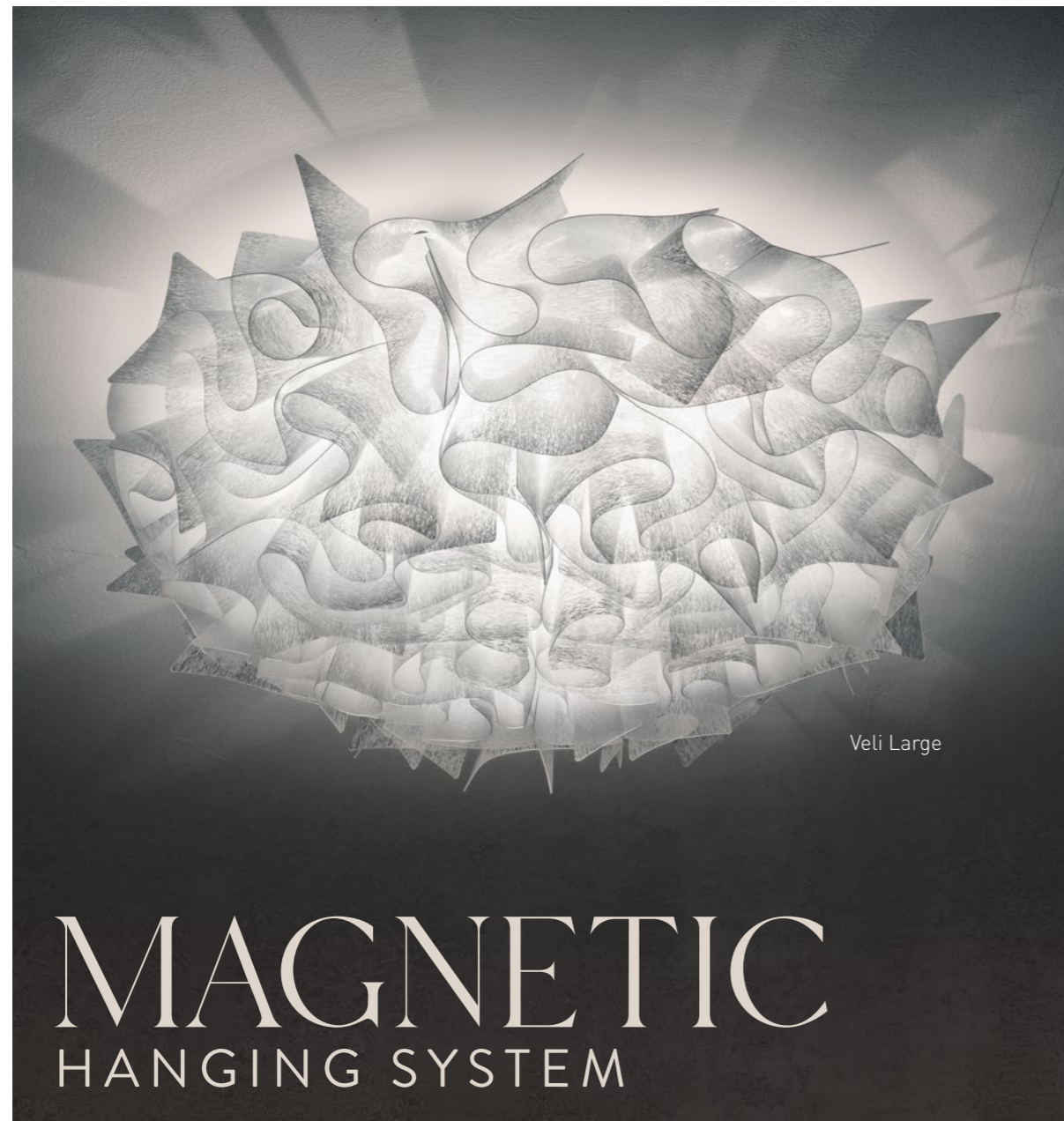
technical details p. 556



CEILING LAMP

A soft finish that was inspired by modern fabric textures.

Inedita finitura ispirata alle texture tessili contemporanee.

- 
 SUSPENSION
p.196
- 
 WALL LAMP
p.420
- 
 CEILING LAMP
- 
 TABLE LAMP
p.378
- 
 FLOOR LAMP

veli

PRISMA
BY ADRIANO RACHELE

technical details p.298

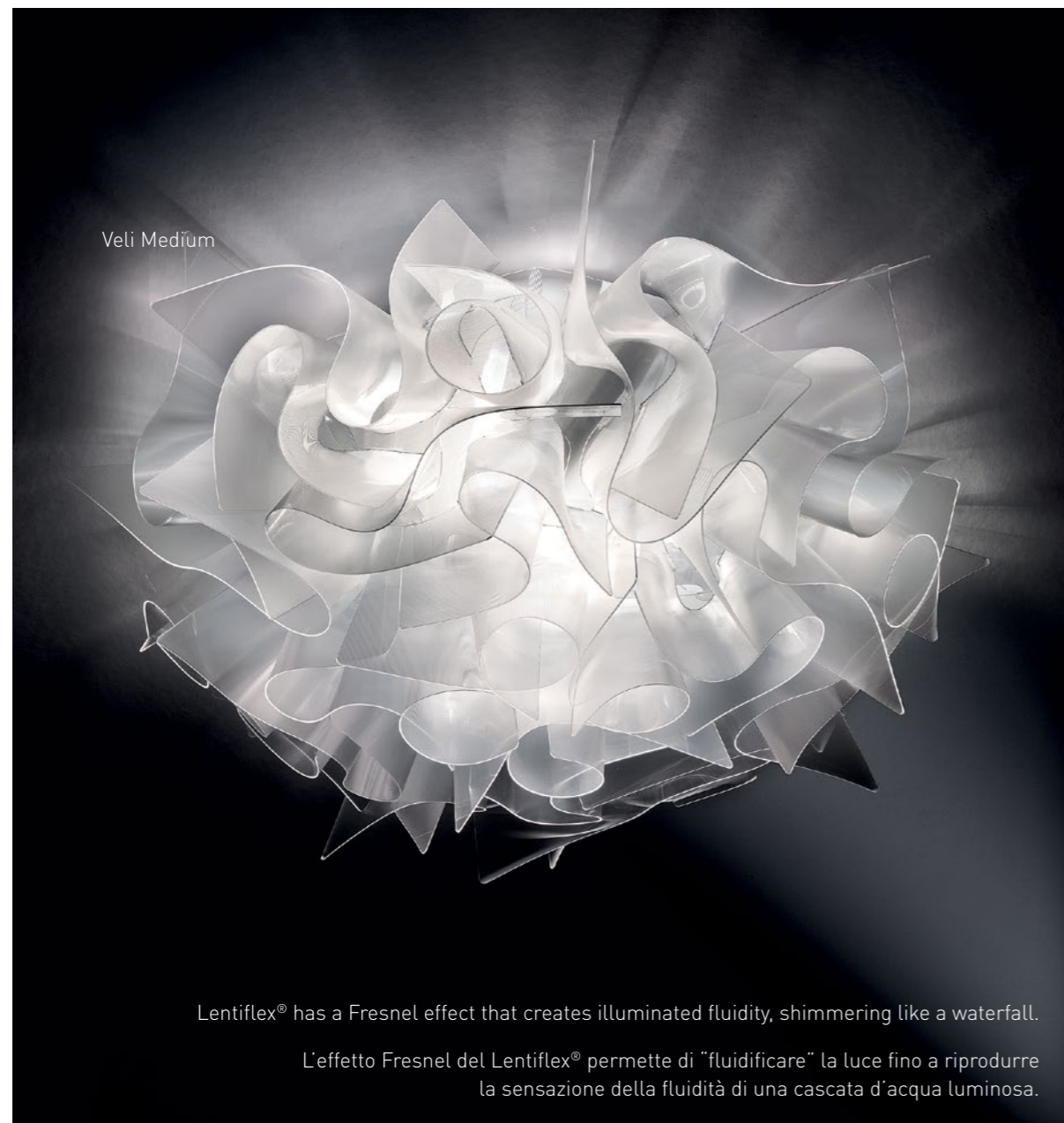

Lentiflex® has a Fresnel effect that creates illuminated fluidity, shimmering like a waterfall.

L'effetto Fresnel del Lentiflex® permette di "fluidificare" la luce fino a riprodurre la sensazione della fluidità di una cascata d'acqua luminosa.



SUSPENSION
p.200



WALL LAMP
p.422



CEILING LAMP



TABLE LAMP



FLOOR LAMP

UNIQUE MATERIALS



LENTIFLEX®

CEILING LAMP

veli

GOLD, SILVER
& COPPER
BY ADRIANO RACHELE

technical details p. 556



Veli Large Silver



Veli Medium Gold

SUSPENSION
p.202

WALL LAMP
p.424

CEILING LAMP
p.300

TABLE LAMP

FLOOR LAMP



Veli Copper

veli

BY ADRIANO RACHELE

technical details p. 556

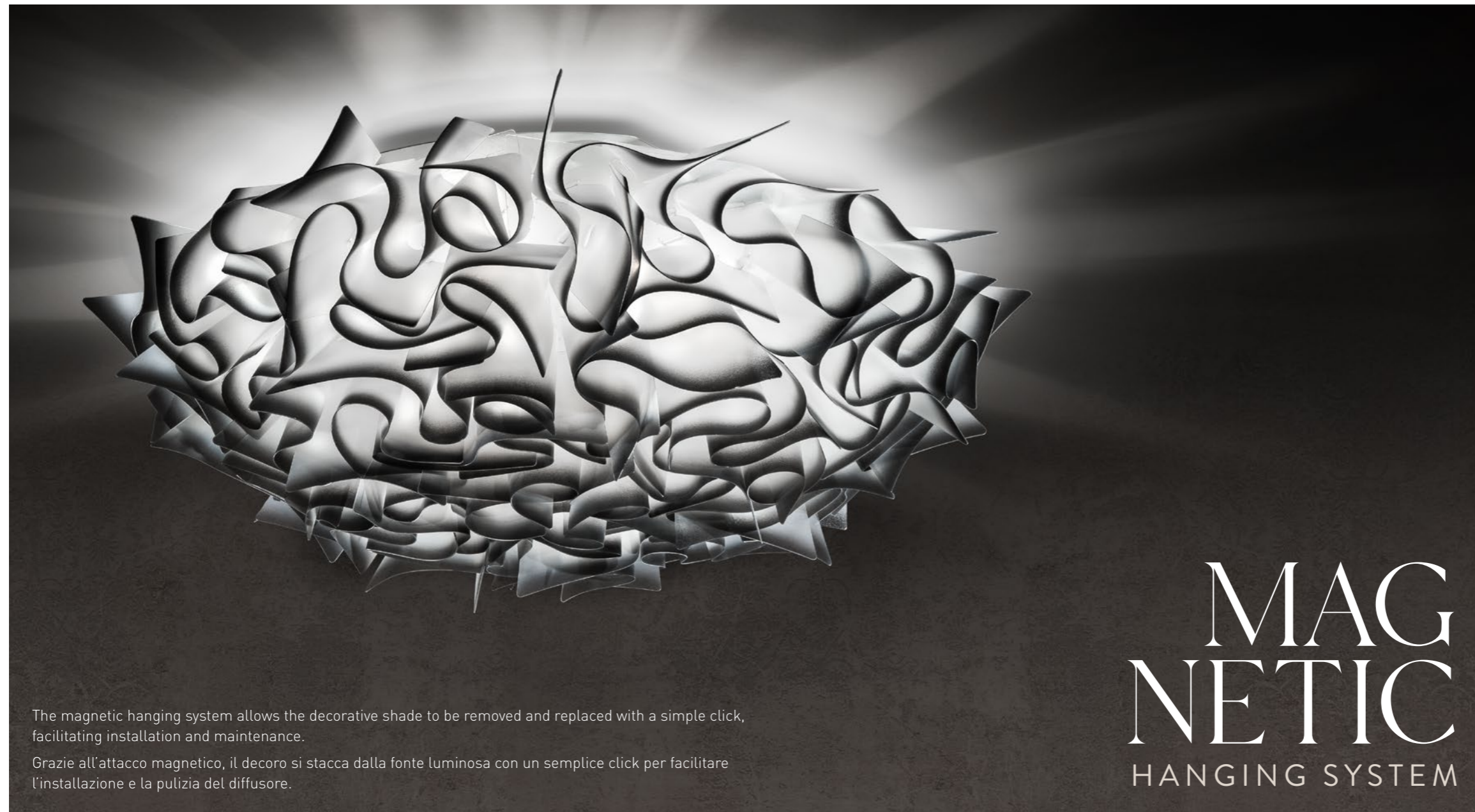

The magnetic hanging system allows the decorative shade to be removed and replaced with a simple click, facilitating installation and maintenance.

Grazie all'attacco magnetico, il decoro si stacca dalla fonte luminosa con un semplice click per facilitare l'installazione e la pulizia del diffusore.

MAGNETIC

HANGING SYSTEM

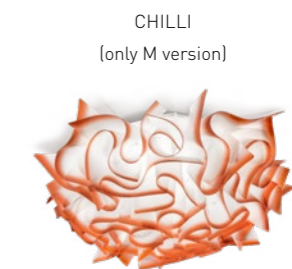
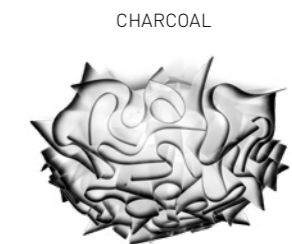
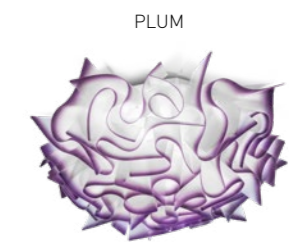
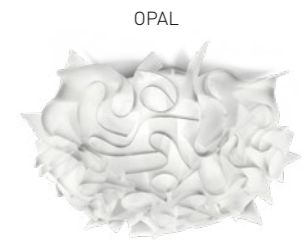

CEILING LAMP





reddot design award
honourable mention 2012

A series of handcrafted elements delicately connect to create sinuous, elegant design. Veli is available in a selection of colors and sizes offering flexible options for every kind of space.

Tramite un sistema di incastri eseguiti a mano, Veli si articola in un design sinuoso ed elegante capace di valorizzare ogni interior.



DECO RATIVE

DETAILS

hanami

BY ADRIANO RACHELE

technical details p. 539



SUSPENSION
p.210

WALL LAMP
p.450

CEILING LAMP

TABLE LAMP

FLOOR LAMP



CEILING LAMP

Every bloom is handcrafted
with 15 folds

Sono necessarie 15 piegature
manuali per realizzare
ciascun fiore.

la belle étoile

BY ADRIANO RACHELE

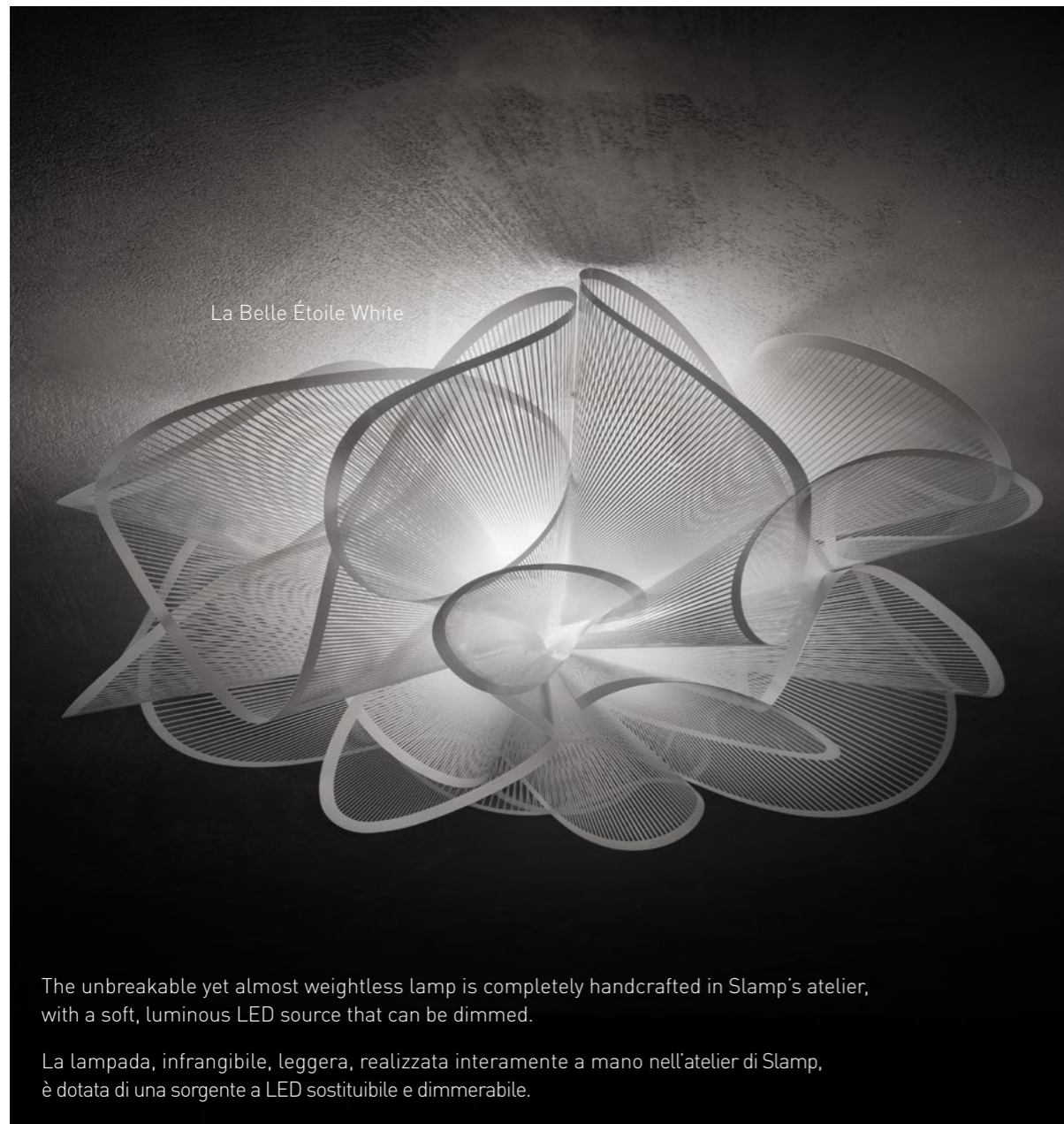

La Belle Étoile White

The unbreakable yet almost weightless lamp is completely handcrafted in Slamp's atelier, with a soft, luminous LED source that can be dimmed.

La lampada, infrangibile, leggera, realizzata interamente a mano nell'atelier di Slamp, è dotata di una sorgente a LED sostituibile e dimmerabile.



SUSPENSION
p.126



WALL LAMP
p.452



CEILING LAMP



TABLE LAMP



FLOOR LAMP



technical details p. 543

La Belle Étoile Black

BLACK
GRA
PHICS

CEILING LAMP

étoile

BY ADRIANO RACHELE

technical details p. 535



Étoile Prisma



fluid Lentiflex® detail

Size/Dimensione:
Ø73 x h. 23 cm - Ø28-1/2" x 8-3/4"
Lighting/Illuminazione:
LED 15W - 220-240 Vac/40 Vdc
2.150 Lumen 2700 Kelvin - CRI 90

-  SUSPENSION
p.134
-  WALL LAMP
p.454
-  CEILING LAMP
-  TABLE LAMP
-  FLOOR LAMP

fabula

BY COSTANTINO MOROSIN

technical details p. 536

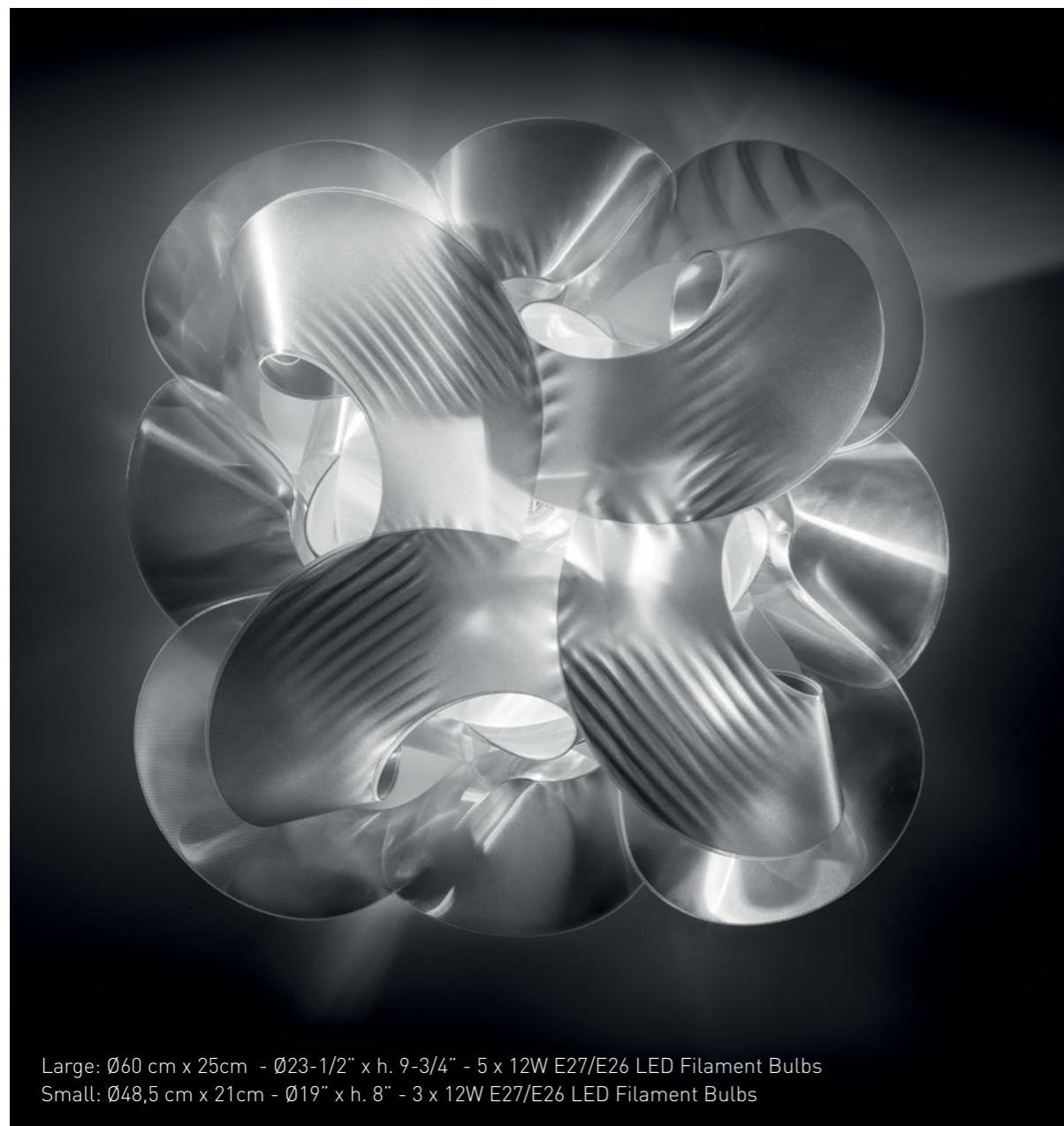

Large: Ø60 cm x 25cm - Ø23-1/2" x h. 9-3/4" - 5 x 12W E27/E26 LED Filament Bulbs
Small: Ø48,5 cm x 21cm - Ø19" x h. 8" - 3 x 12W E27/E26 LED Filament Bulbs



SUSPENSION
p.216



WALL LAMP
p.456



CEILING LAMP



TABLE LAMP



FLOOR LAMP



SILKY
FABRIC

CEILING LAMP

bios

BY NIGEL COATES

technical details p. 526



Available in 3 sizes
 Disponibile in 3 dimensioni:
 L: Ø72 x h. 15 cm - Ø28-1/4" x h. 6"
 M: Ø54 x h. 12 cm - Ø21-1/4" x h. 4-3/4"
 S: Ø36 x h. 8,5 cm - Ø14-1/4" x h. 3-1/4"

- 
 SUSPENSION
- 
 WALL LAMP
 p.460
- 
 CEILING LAMP
- 
 TABLE LAMP
- 
 FLOOR LAMP
 p.504

aurora

BY NIGEL COATES



Aurora Large Black

Core covered in Schöler crystals.
Available in 2 sizes.

Struttura centrale con cristalli
Schöler. Disponibile in 2 misure.



SUSPENSION

WALL LAMP

CEILING LAMP

TABLE LAMP

FLOOR LAMP



Aurora Large White

SCHÖLER
CRYSTALS

CEILING LAMP

dafne

BY NIGEL COATES

technical details p. 533



A nymph transformed into a tree: the myth and images that inspired the name.
 Il nome della lampada porta con sé l'immaginario mitico della trasformazione della Ninfa da donna in arbusto.

- 
 SUSPENSION
 p.250
- 
 WALL LAMP
 p.462
- 
 CEILING LAMP
- 
 TABLE LAMP
- 
 FLOOR LAMP
 p.506

venti

BY ALESSANDRO MENDINI

technical details p. 558



- 
 SUSPENSION
- 
 WALL LAMP
 p.466
- 
 CEILING LAMP
- 
 TABLE LAMP
- 
 FLOOR LAMP
 p.514



Available in 3 sizes / Disponibile in 3 dimensioni:
 Large: Ø72 x h. 15 cm - 28-1/4" x h. 6" ; Medium: Ø54 x h. 12 cm - 21-1/4" x h. 4-3/4"
 Small: Ø36 x h. 8,5 cm - 14-1/4" x h. 3-1/4"

TABLE

LAMPS

SLAMP:

accordéon BATTERY

BY MARC SADLER

technical details p. 520



- 
 SUSPENSION
 p.166
- 
 WALL LAMP
- 
 CEILING LAMP
- 
 TABLE LAMP
 p.330
- 
 FLOOR LAMP



BAT
 TE
 RY
 POWERED

TABLE LAMP

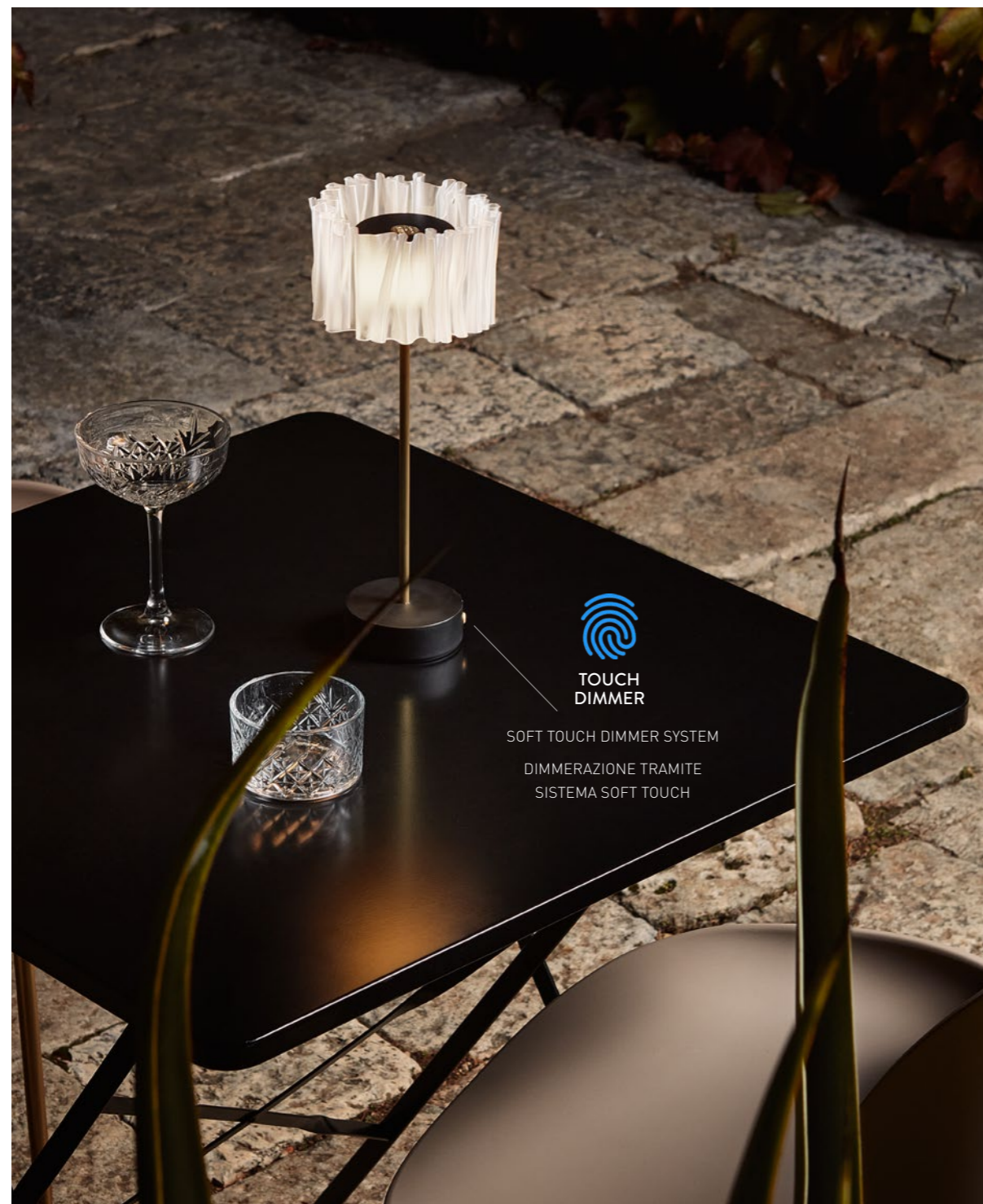

What appears to be pleated, weightless fabric is actually undulating Lentiflex®, lit by a dimmable LED from within, resting on an anodized aluminum stem.

Quella che ricorda una fascia di tessuto impalpabile e plissettato è in realtà una struttura in Lentiflex® ondulato, illuminata dall'interno da una fonte luminosa LED dimmerabile e sorretta da un grazioso stelo in alluminio anodizzato.

HAND MOLDED

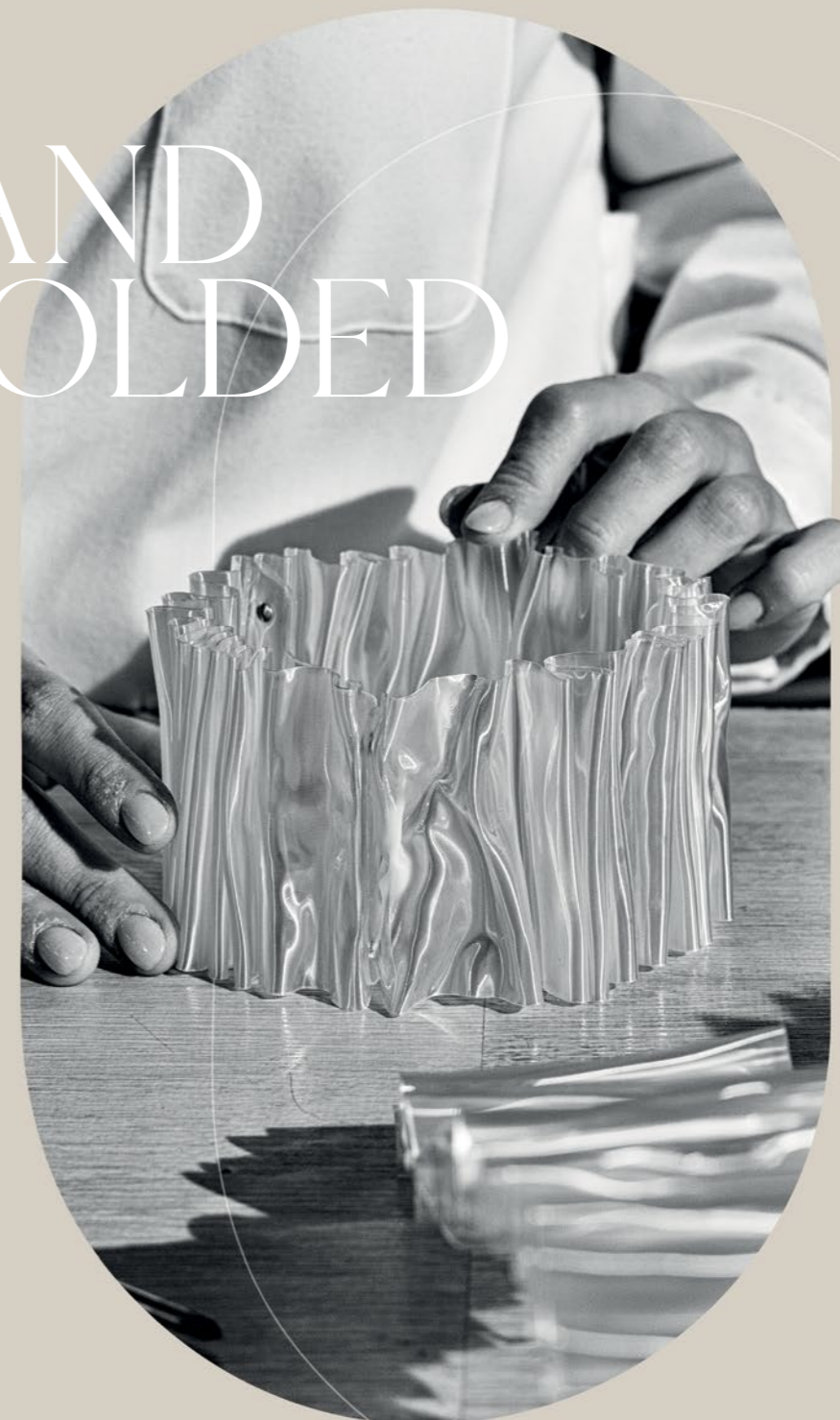



accordéon

BY MARC SADLER



SUSPENSION
p.166



WALL LAMP



CEILING LAMP



TABLE LAMP
p.324



FLOOR LAMP



TABLE LAMP

DUAL POSITION ILLUMINATION

The internal structure and clasp match the fluidity of the external plissé diffusor and prevent the accumulation of dust. The lamp has dual switches, one for the shade and another for the base. Both light sources can be used together, and cast a uniform glow and a cotton-like silhouette. The table lamp's shade and sockets have magnets to facilitate cleaning and changing the bulbs.

La struttura interna e l'elemento di chiusura superiore della lampada da tavolo sono sagomati per assecondare il movimento del plissé ed evitare l'accoglienza della polvere. La lampada è dotata di doppia accensione, permettendo di accendere il diffusore indipendentemente o contestualmente alla base, che si illumina in modo uniforme ricreando la trama di un tessuto di cotone. Sia il diffusore che i portalampane sono dotati di attacco magnetico per agevolare pulizia e sostituzione delle lampadine.



SHADE ON

BASE ON

SHADE AND BASE ON



Size / Dimensione:
 Ø37 x h. 48 cm
 Ø14-1/2" x h. 18-3/4"

A PATENTED



MOLDING PROCESS

tulip

BATTERY
BY MARC SADLER



SUSPENSION
p.82

WALL LAMP

CEILING LAMP

TABLE LAMP

FLOOR LAMP

technical details p. 553



BLACK BASE

WHITE BASE

TABLE LAMP



Battery:
at max. intensity around 6 hours duration,
at min. intensity around 60 hours duration.

Batteria:
al massimo dell'intensità durata di 6 ore,
al minimo dell'intensità 60 ore di durata



Brightness intensity can be regulated using the soft touch system. The battery duration lasts around 6 hours at full brightness, and up to 60 at minimum brightness.

Regolazione intensità luminosa tramite sistema touch a sfioramento – durata della batteria di 6 ore al massimo della potenza e intorno alle 60 ore al minimo d'intensità



A cold application of gold foil creates a unique texture that printing or paints cannot replicate.

La lamina dorata viene applicata a freddo sul materiale creando un effetto materico irripetibile con vernici o stampe.



Slamp's exclusive, unbreakable Lentiflex® technopolymer is manually sculpted at a controlled temperature to create an illuminated bloom.

La modellazione manuale a temperatura controllata del Lentiflex®, tecnopolimero infrangibile di Slamp, dà vita ai boccioli luminosi di Tulip.

BAT TE RY POWERED

technical details p. 553



SIMULTANEOUSLY CHARGE
20 TULIP WITH
THE USB CHARGING STATION
(IDEAL FOR HO.RE.CA)



 BATTERY
POWERED

TABLE LAMP

lafleur

BATTERY
BY MARC SADLER

technical details p. 546



BATTERY

POWERED



-  SUSPENSION
-  WALL LAMP
p.434
-  CEILING LAMP
-  TABLE LAMP
-  FLOOR LAMP



LaFleur is a delicate, rechargeable table lamp, made with thermoformed Lentiflex® and molded by hand to create a soft, poetic crown. The flower's pistils help dissipate the LED warmth.

LaFleur è una delicata lampada da tavolo con batteria ricaricabile, realizzata riscaldando il Lentiflex® e modellandolo a mano fino a creare una corolla morbida e poetica. Il pistillo ha la funzione di dissipare il calore dei LED.

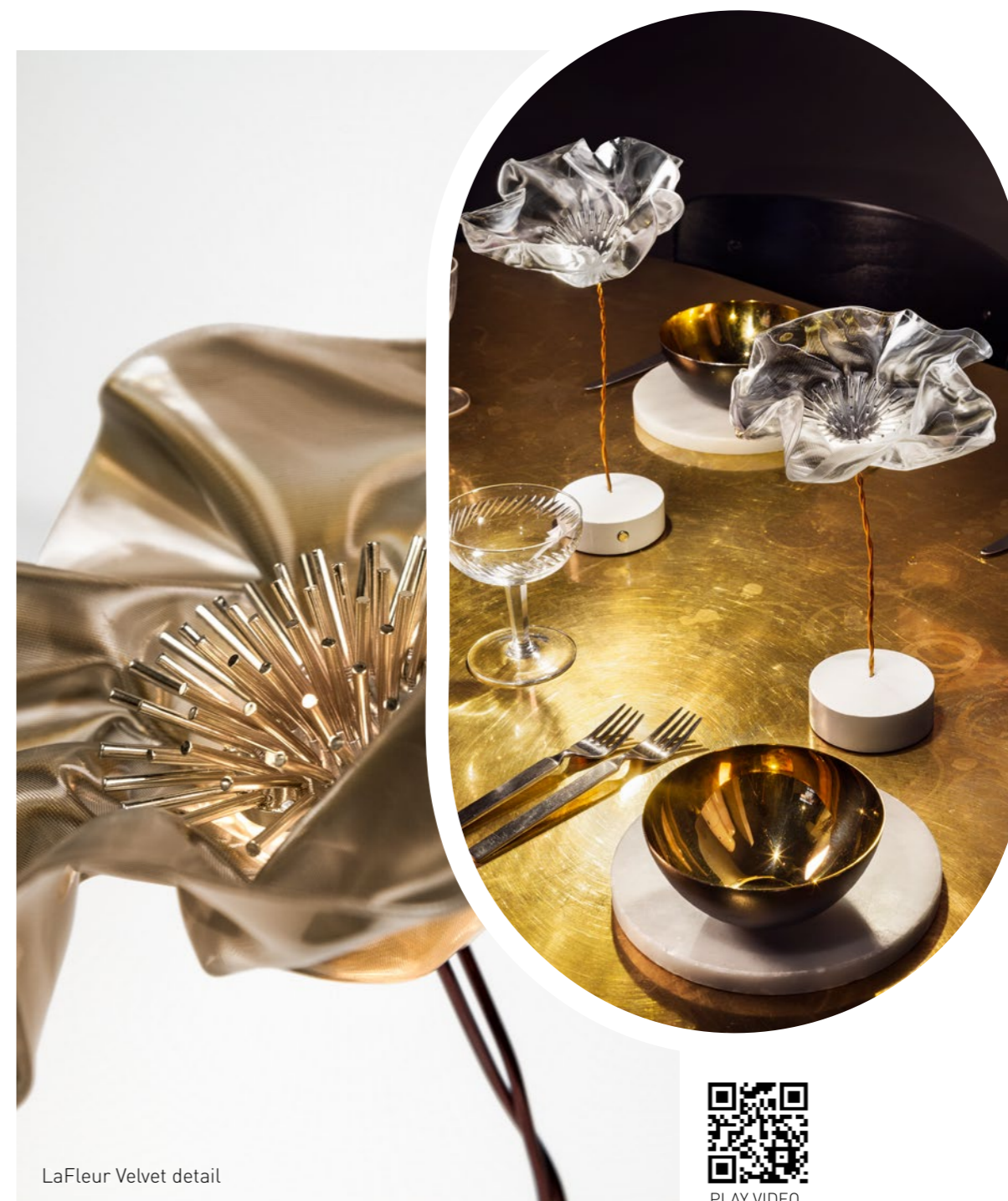

SIMULTANEOUSLY CHARGE
20 LAFLEUR WITH
THE USB CHARGING STATION
(IDEAL FOR HO.RE.CA)



Battery/Batteria:
at max. intensity around 6.5 hours duration, at min. intensity around 60 hours duration.
Al massimo dell'intensità durata di 6.5 ore, al minimo dell'intensità 60 ore di durata

A
PATE
NTED



MOLDING
PROCESS

clizia

BATTERY
MAMA NON MAMA
BY ADRIANO RACHELE

technical details p. 532



SUSPENSION
p.136

WALL LAMP
p.404

CEILING LAMP
p.262

TABLE LAMP

FLOOR LAMP

2013 - 2023
CLIZIA
10th ANNIVERSARY



TABLE LAMP



A cold application of gold foil creates a unique texture that printing or paints cannot replicate.
La lamina dorata viene applicata a freddo sul materiale creando un effetto materico irripetibile con vernici o stampe.



SIMULTANEOUSLY CHARGE
20 CLIZIA WITH
THE USB CHARGING STATION
(IDEAL FOR HO.RE.CA)

From warmer months dining al fresco, to an intimate indoor occasion, a forever-glowing bloom.
Al termine della bella stagione rimane con te, come un prezioso complemento d'arredo.



clizia

BATTERY
BY ADRIANO RACHELE



SUSPENSION
p.144

WALL LAMP
p.412

CEILING LAMP
p.268

TABLE LAMP

FLOOR LAMP

technical details p. 532

HAND



MADE



Brightness intensity can be regulated using the soft touch system. The battery duration lasts around 6.5 hours at full brightness, and up to 60 at minimum brightness.

Regolazione intensita' luminosa tramite sistema touch a sfioramento - durata della batteria di 6,5 ore al massimo della potenza e intorno alle 60 ore al minimo d'intensita'



Prisma finish detail

Alali Restaurant, Astarte Suites, Santorini, Greece

clizia

MAMA NON MAMA
BY ADRIANO RACHELE

technical details p. 532



A comfortably 180 cm (70") long electrical wire.
Comodo cavo elettrico con interruttore lungo 180 cm (70").



TABLE LAMP

- 
 SUSPENSION
p.136
- 
 WALL LAMP
p.404
- 
 CEILING LAMP
p.262
- 
 TABLE LAMP
- 
 FLOOR LAMP

clizia

BY ADRIANO RACHELE

technical details p. 532



Fumè



Clizia Table White



BLACK

ORANGE

PURPLE

WHITE

FUMÉ

TABLE LAMP



SUSPENSION
p.150

WALL LAMP
p.416

CEILING LAMP
p.272

TABLE LAMP

FLOOR LAMP

idea

BY MARCANTONIO

technical details p. 541



SUSPENSION



WALL LAMP
p.438



CEILING LAMP



TABLE LAMP



FLOOR LAMP



MARCANTONIO



Size / Dimensioni: Ø15 x h. 45,5 cm
Ø5-3/4" x h. 17-3/4"

By removing everything structural and decorative, what remains is the distillation of light: a lightbulb with a golden base, "magically" suspended on a brass arm. The G9 light source is easily changed by simply unscrewing it from the base.

Eliminato tutto ciò che in un corpo luminoso è un surplus di elementi decorativi, ciò che ne rimane è la vera essenza della luce: una lampadina con virola dorata "magicamente" sospesa su un'asta di ottone spazzolato. La fonte luminosa G9 all'interno della virola è svitabile per essere sostituita agevolmente.

The bulb angle can differ from lamp to lamp and is not predetermined.

L'inclinazione del bulbo sull'asta potrebbe differire tra un pezzo e l'altro e non è predeterminabile.

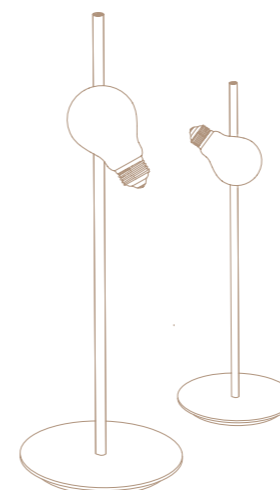

Lighting / Illuminazione: 1 x 5W G9 LED Bulb

moon

25TH ANNIVERSARY
BY SLAMP CREATIVE DEPARTMENT



Size / Dimensioni: 30 x 14 x h 57cm - 11-3/4" x 5-1/2" x h. 22-1/4"
Brushed brass sides. Printed marble texture facade.
Profili in ottone spazzolato. Texture effetto marmo stampata sul fronte.

- 
SUSPENSION
- 
WALL LAMP
- 
CEILING LAMP
- 
TABLE LAMP
- 
FLOOR LAMP



WHITE

technical details p. 548

BLACK

PINK

TABLE LAMP

liza

BY ELISA GIOVANNONI

technical details p. 547



Liza Pewter

Size / Dimensioni:
Ø35 cm x h. 70 cm
Ø13" x h. 27"

TABLE LAMP

-  SUSPENSION
p.244
-  WALL LAMP
-  CEILING LAMP
-  TABLE LAMP
-  FLOOR LAMP



A baroque-inspired masterpiece that unites tradition with haute design, using Slamp's technopolymers; the dual illumination includes a E27/E26 LED bulb in the main diffuser and a courtesy G9 LED bulb in the base, and each can be used independently.



Masterpiece d'ispirazione barocca che unisce un design dal sapore tradizionale all'uso dei tecnopolimeri di Slamp. Dotata di un sistema di doppia illuminazione: lampadina G9 LED di cortesia nella base e lampadina E27/E26 nel cappello, con accensione indipendente.

overlay

BY ANALOGIA PROJECT



Size / Dimensioni:
43 x 17 cm x h. 52 cm - 17" x 6-1/2" x h. 20-1/2"

**MONT
BLANC**

-  SUSPENSION
-  WALL LAMP
-  CEILING LAMP
-  TABLE LAMP
-  FLOOR LAMP

technical details p. 551

MUL TIPL



LAYERS

TABLE LAMP



OVERLAY AND MONTBLANC
MEISTERSTÜCK SET

The ballpoint pen is sold with the lamp
in an elegant personalized case

Venduta in combinata alla penna a sfera
in un cofanetto personalizzato

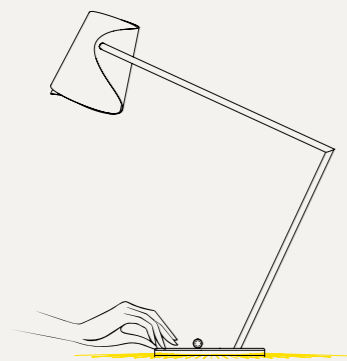

The sensitive touch system turns on the LED
courtesy light in the brass base.
Il pulsante a sfioramento accende la luce LED
di cortesia nella base in ottone.

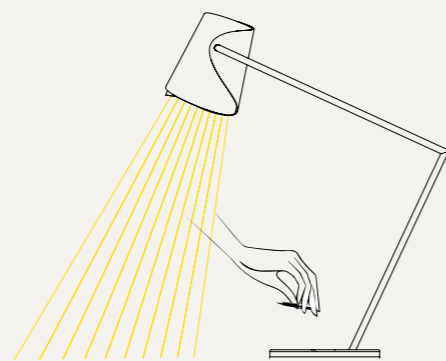

Lifting the writing instrument from the leather rest
turns on the main LED light in the Copperflex® shade.
Sollevando lo strumento da scrittura dall'alloggio in pelle,
si accende la luce LED nel diffusore in Copperflex®.



The best gift to give passionate writers is the freedom to create without having to do anything else, without interrupting their inspirational flow: lift the pen and begin. Overlay was born of this concept. The perfect writing lamp's shade is illuminated the moment one lifts the Montblanc Meisterstück Le Grand, included with the lamp. The only thing left to do is choose the type of pen stroke.

Il più grande regalo che si può fare agli appassionati di scrittura è lasciare che, colti dall'ispirazione, non debbano pensare ad altro che a sollevare la penna e incidere per sempre sulla carta i loro pensieri. E così nasce Overlay, la perfetta lampada da scrittura, il cui diffusore si accende semplicemente sollevando la Montblanc Meisterstück Le Grand fornita in combinata con la lampada. Basta solo scegliere quale tratto di scrittura si preferisce.

veli

FOLIAGE
BY ADRIANO RACHELE

technical details p. 557



Veli is handcrafted with 268 petals; no glue, and no screws.

Il diffusore di Veli conta fino a 268 incastri manuali, senza colle o viti

- 
 SUSPENSION
p.192
- 
 WALL LAMP
p.420
- 
 CEILING LAMP
p.294
- 
 TABLE LAMP
- 
 FLOOR LAMP

TABLE LAMP

veli

BY ADRIANO RACHELE

technical details p. 556



Veli Table Couture



Veli Table Opal

TABLE LAMP

- 
 SUSPENSION
 p.196
- 
 WALL LAMP
 p.420
- 
 CEILING LAMP
 p.296
- 
 TABLE LAMP
- 
 FLOOR LAMP

Size / Dimensione:
 Ø32 cm x h. 25 cm - Ø12-1/2" x h. 8-3/4"
 Integrated magnetic system. Dotata di attacco magnetico.

fiorellina

BY NIGEL COATES

technical details p. 537



Size / Dimensioni:
 Ø33 cm x h. 34 cm - Ø13" x h. 13"

- 
 SUSPENSION
 p.242
- 
 WALL LAMP
 p.464
- 
 CEILING LAMP
- 
 TABLE LAMP
- 
 FLOOR LAMP



Available in 3 metallized versions (Gold, Silver, Copper) and a White version.
Disponibile in 3 versioni metallizzate (Gold, Silver, Copper) e una bianca.



bach

BY FRANCESCO PARETTI



Gold



SUSPENSION



WALL LAMP



CEILING LAMP



TABLE LAMP



FLOOR LAMP
p.484

technical details p. 526

AN ILLUMINATED COLU MN



White

Available in Gold and White.
Table (2 sizes) and floor (3 sizes)
versions available. Disponibile in Gold e
White. 2 misure da tavolo 3 da terra.

atmosfera

BY LORENZA BOZZOLI

technical details p. 523



TABLE LAMP

- 
 SUSPENSION
 p.248
- 
 WALL LAMP
- 
 CEILING LAMP
- 
 TABLE LAMP
- 
 FLOOR LAMP

cactus

BY ADRIANO RACHELE

technical details p. 528



Cactus S Gold



Constructed using a hand folded system. This page: XM and XS Prisma version. Previous: Cactus Small Gold.

Sistema di incastri eseguito a mano. In questa pagina la versione Prisma XM e XS. Nella pagina precedente la versione Small Gold

Cactus XM Prisma

Cactus XS Prisma

SUSPENSION
p.232

WALL LAMP

CEILING LAMP

TABLE LAMP

FLOOR LAMP
p.496

diamond

BY PAOLUCCI / STATERA

technical details p. 534



Diamond Small



Diamond Small

Diamond features illuminated geometric facets.
Diamond ha un design geometrico che, incontrando la luce, ne accentua le forme sfaccettate.

-  SUSPENSION
 -  WALL LAMP
 -  CEILING LAMP
 -  TABLE LAMP
 -  FLOOR LAMP
- p.512

TABLE LAMP

gemmy

BY RAGNISCO, SPALLETTA,
CROCE, WIJFFELS



Gemmy Multicolor



SUSPENSION
p.250



WALL LAMP



CEILING LAMP



TABLE LAMP



FLOOR LAMP



POLY EDRICH

FACETS

Gemmy Arlecchino

TABLE LAMP

gemmy PRISMA

BY RAGNISCO, SPALLETTA,
CROCE, WIJFFELS

technical details p. 538



TABLE LAMP

PRISMA GOLD

PRISMA

AMBER

EMERALD

AMETHYST

Size / Dimensioni:
 Ø22 cm x h. 33 cm - Ø8-3/4" x h. 13"
 White steel base. Base in acciaio
 bianco verniciato

- 
 SUSPENSION
 p.252
- 
 WALL LAMP
- 
 CEILING LAMP
- 
 TABLE LAMP
- 
 FLOOR LAMP

las palmas

BY PAOLUCCI
STATERA

technical details p. 546

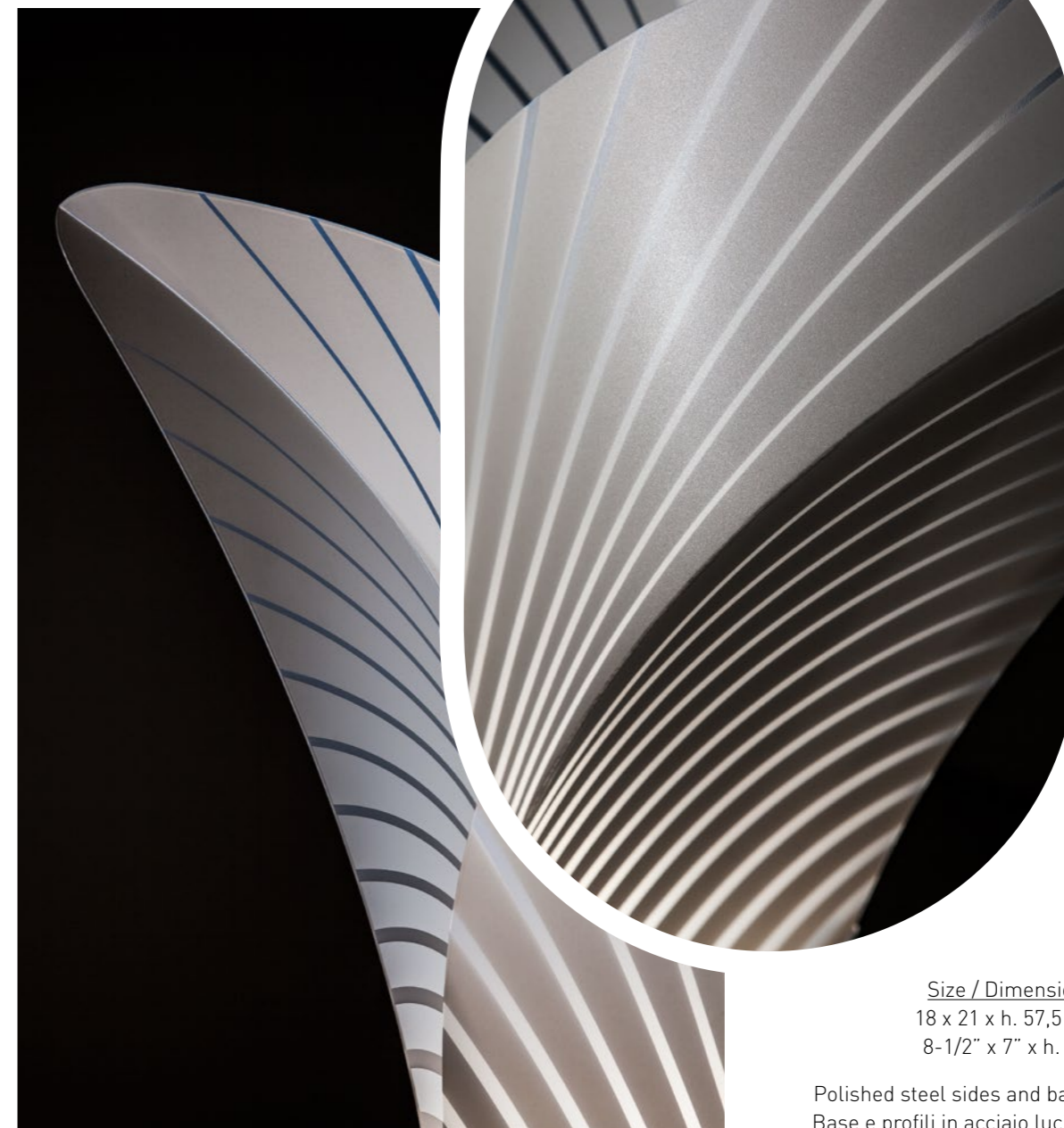

Size / Dimensioni:
18 x 21 x h. 57,5 cm
8-1/2" x 7" x h. 22"

Polished steel sides and base.
Base e profili in acciaio lucido.



WALL

LAMPS

SLAMP:

la lollo

BY LORENZA BOZZOLI



La Lollo Applique Gold

-  SUSPENSION
p.180
-  WALL LAMP
-  CEILING LAMP
-  TABLE LAMP
-  FLOOR LAMP
p.480

technical details p. 544



A TRIBUTE TO THE
**ROA
RING**
'50S



La Lollo Gradient



La Lollo Pewter/White

Size / Dimensioni: 28 x 16 x h.30 cm
11" x 6-1/4" x h. 11 3/4".

Lighting/Illuminazione: 2 x 6W LED
Filament Bulbs E14/E12.

clizia

MAMA NON MAMA
BY ADRIANO RACHELE



Clizia Medium Mama non Mama - Gold

-  SUSPENSION
p.136
-  WALL LAMP
-  CEILING LAMP
p.262
-  TABLE LAMP
p.348
-  FLOOR LAMP

technical details p. 531



Clizia Medium Mama non Mama - White

MAGNETIC

HANGING SYSTEM

WALL LAMP



Clizia Large and Medium Mama non Mama - Black

Lighting / Illuminazione:

Ceiling/Wall Available in 3 sizes - Disponibile in 3 misure.

L: 3 x 12W E26/E27 - M: 2 x 12W E26/E27 - Mini: 2 x 6W E12/E14 LED Filament Bulbs.



Couture finish detail

Clizia Mini Mama non
Mama - Gold

The integrated magnetic system facilitates cleaning and maintenance.

Dotata di attacco magnetico per veloce pulizia e manutenzione.

clizia

APPLIQUE
MAMA NON MAMA
BY ADRIANO RACHELE



Clizia Applique Mama non Mama - White

-  SUSPENSION
p.136
-  WALL LAMP
p.404
-  CEILING LAMP
p.262
-  TABLE LAMP
p.348
-  FLOOR LAMP



technical details p. 532

Clizia Applique
Mama non Mama -Black

WALL LAMP



Clizia Applique Mama non Mama - Gold



Size / Dimensione: 32 x 15 x h. 28 cm
2-1/2" x 5-3/4" x h. 9-3/4"

Lighting/Illuminazione: 2 x 6W LED
Filament Bulbs E12/E14.

clizia

FUMÉ
BY ADRIANO RACHELE



SUSPENSION
p.144



WALL LAMP



CEILING LAMP
p.268



TABLE LAMP
p.354



FLOOR LAMP

technical details p. 531

MAGNETIC

HANGING SYSTEM

WALL LAMP

clizia

PIXEL
BY ADRIANO RACHELE



Clizia Large Pixel

Clizia Medium Pixel

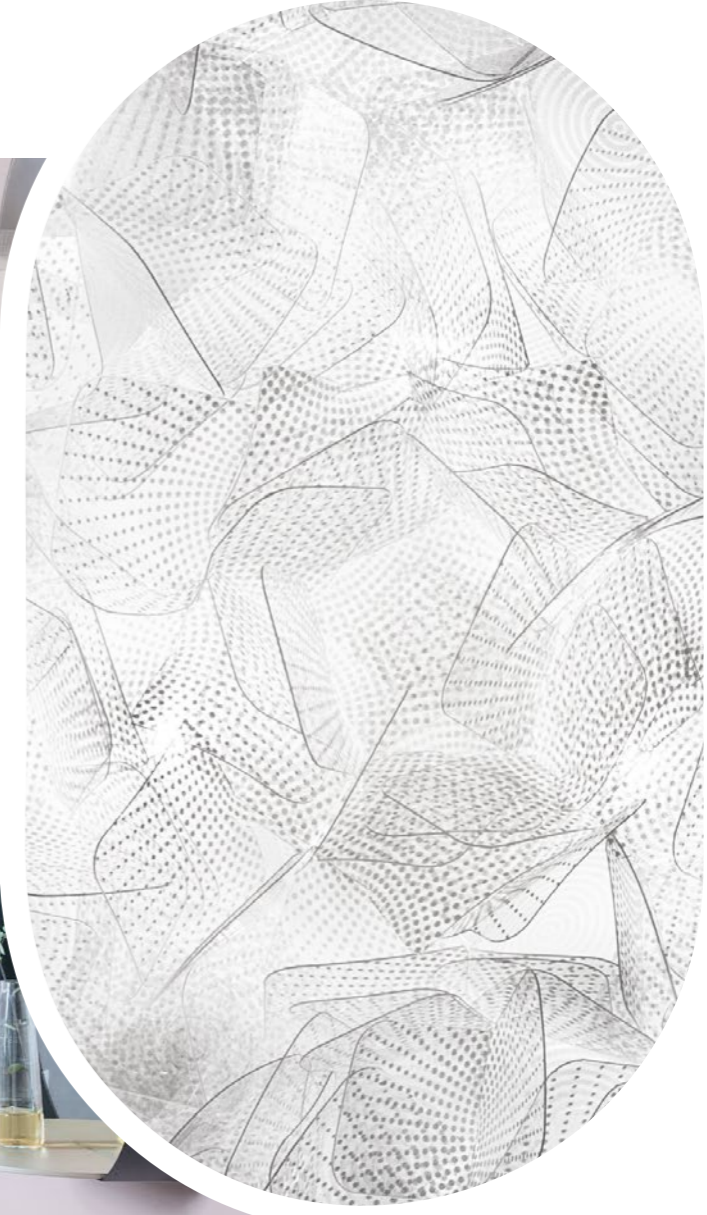

Clizia is covered in pixel: a high-tech pattern meets soft tones that enhance the lamp's lush volume.
Clizia si tinge di Pixel: una decorazione high-tech in tonalità tenui che si dipana sul volume rigoglioso della lampada.

- 
SUSPENSION
p.148
- 
WALL LAMP
- 
CEILING LAMP
p.270
- 
TABLE LAMP
- 
FLOOR LAMP

clizia

BY ADRIANO RACHELE



Clizia Large White



SUSPENSION
p.150



WALL LAMP



CEILING LAMP
p.272



TABLE LAMP
p.360



FLOOR LAMP



Clizia Mini White

HAND
FOLDED

WALL LAMP

veli

FOLIAGE
BY ADRIANO RACHELE

technical details p. 557



Veli Large



WALL LAMP

Integrated magnetic hanging system. Available in 3 sizes: L, M, Mini.

Dotata di attacco magnetico, disponibile in 3 misure: L, M, Mini.

- 

SUSPENSION
p.192
- 

WALL LAMP
- 

CEILING LAMP
p.294
- 

TABLE LAMP
p.376
- 

FLOOR LAMP

veli COUTURE

BY ADRIANO RACHELE

technical details p. 556



Veli Large Couture



Veli Medium Couture

Couture finish detail

A soft finish that was inspired by modern fabric textures.
Inedita finitura ispirata alle texture tessili contemporanee.

- 
 SUSPENSION
p.196
- 
 WALL LAMP
- 
 CEILING LAMP
p.296
- 
 TABLE LAMP
p.378
- 
 FLOOR LAMP

veli

PRISMA
BY ADRIANO RACHELE

technical details p. 556

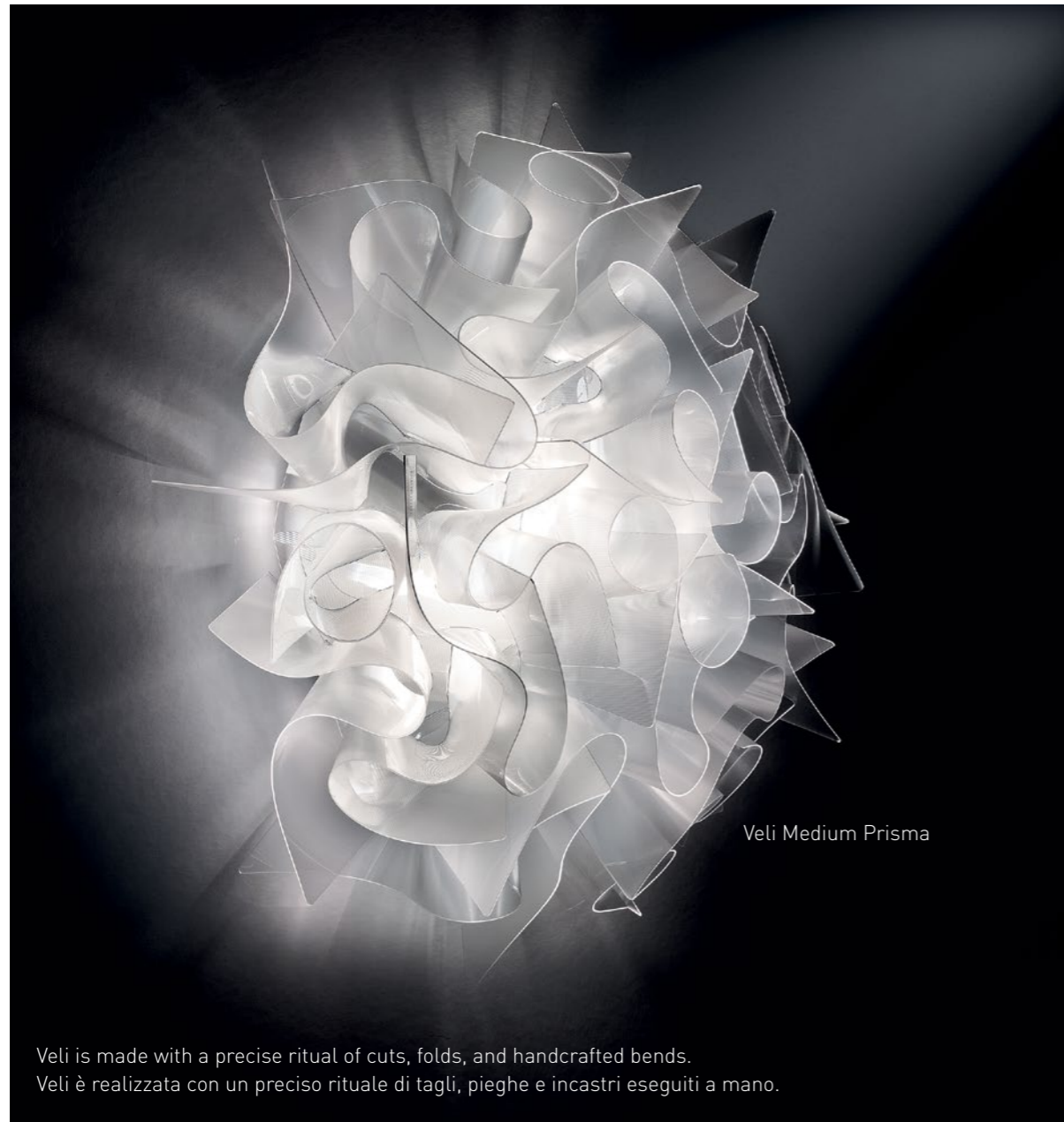

Veli Medium Prisma

Veli is made with a precise ritual of cuts, folds, and handcrafted bends.
Veli è realizzata con un preciso rituale di tagli, pieghe e incastri eseguiti a mano.



SUSPENSION
p.200



WALL LAMP



CEILING LAMP
p.298



TABLE LAMP



FLOOR LAMP

PRECISE
FOLD
ING
RITUAL



Veli Medium Prisma

WALL LAMP

veli

GOLD, SILVER
& COPPER
BY ADRIANO RACHELE

technical details p. 556



WALL LAMP

- 
 SUSPENSION
p.202
- 
 WALL LAMP
- 
 CEILING LAMP
p.300
- 
 TABLE LAMP
- 
 FLOOR LAMP

Slamp's unique, flexible technopolymers undergo metallisation through an exclusive process of aluminium vapourisation that guarantees resistance and shine.

I tecnopolimeri flessibili e unici di Slamp subiscono un esclusivo processo di metallizzazione a vapori di alluminio che garantisce brillantezza e resistenza.

veli

BY ADRIANO RACHELE

technical details p. 556

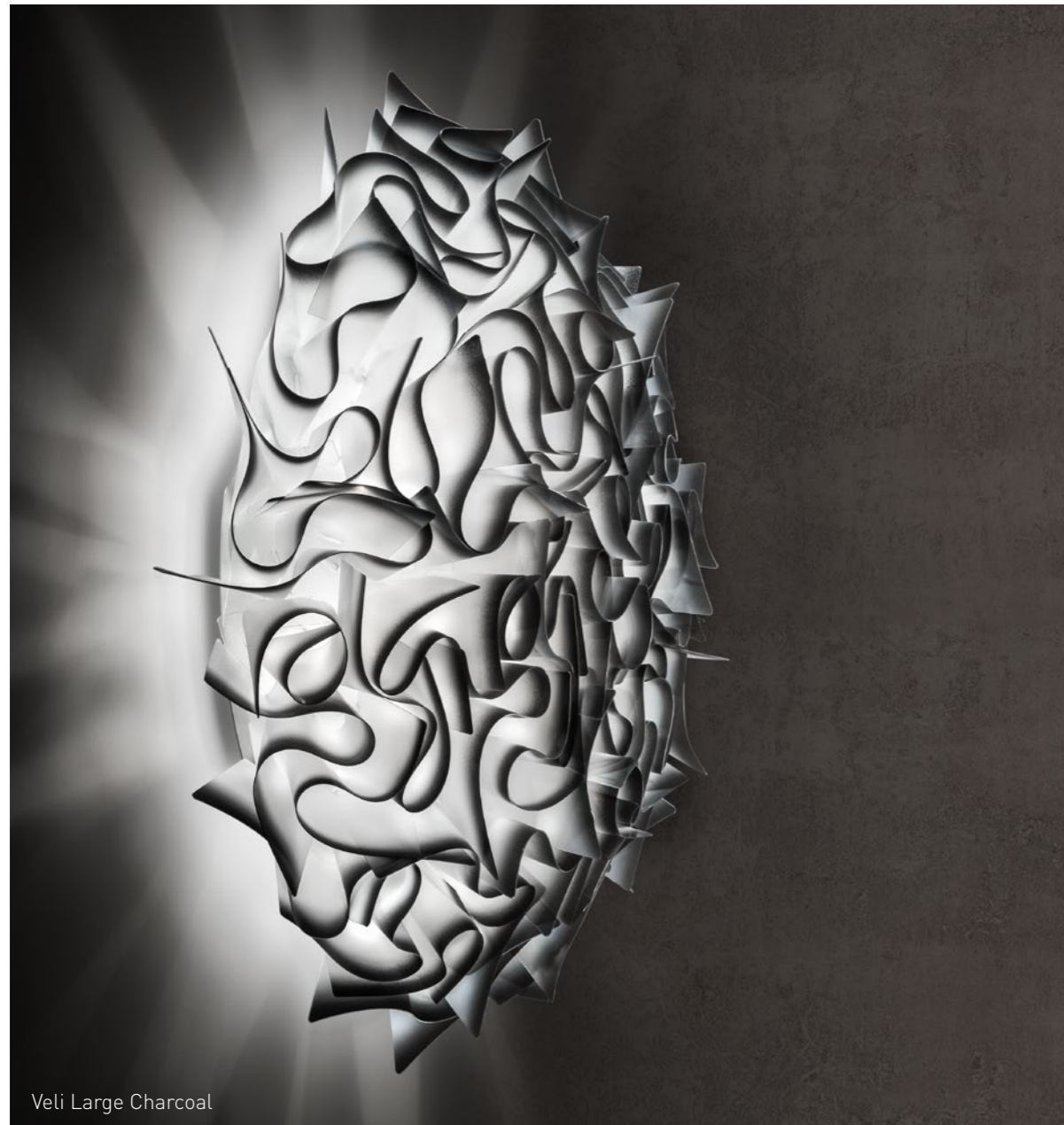

- 
 SUSPENSION
p.204
- 
 WALL LAMP
- 
 CEILING LAMP
p.302
- 
 TABLE LAMP
p.378
- 
 FLOOR LAMP

reddot design award
 honourable mention 2012

A series of handcrafted elements delicately connect to create sinuous, elegant design. Veli is available in a selection of colors and sizes offering flexible options for every kind of space.

Tramite un sistema di incastri eseguiti a mano, Veli si articola in un design sinuoso ed elegante capace di valorizzare ogni interior.

la vie

BY ADRIANO RACHELE



La Vie Medium Multigreen

-  SUSPENSION
-  WALL LAMP
-  CEILING LAMP
p.276
-  TABLE LAMP
-  FLOOR LAMP



technical details p. 545

La Vie Mini Amber

WALL LAMP



The ladies who tailor light quickly form a relationship with the product they specialise in, and this evolving know-how goes hand in hand with the pride and affection they feel for each piece produced.

Le Sarte della Luce acquisiscono una tale capacità di dialogare con il prodotto che già dopo poche settimane sentono una forte affezione nei confronti del modello di cui sono incaricate di seguire la manifattura.

MAGNETIC HANGING SYSTEM



La Vie Medium White





Size / Dimensioni:

Large: 71 x 74 x h. 21 cm - 27-3/4" x 29" x h. 8-1/4"

Medium: 47 x 50 x h. 19 cm - 19-1/2" x 18-1/4" x h. 7-1/2"

Mini: 34 x 36 x h. 15 cm - 13-1/4" x 14" x h. 5-3/4"

BLUE

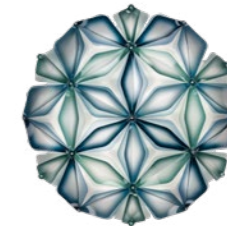

WHITE



AMBER



MULTIGREEN

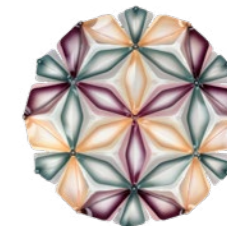

MULTIBLUE

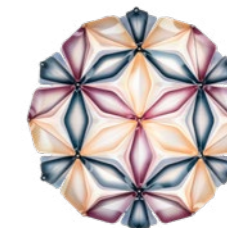

lafleur

BY MARC SADLER

technical details p. 546



LaFleur Prisma



Prisma detail

The G4 LED bulb can be dimmed with a Triac system, creating a soft glow.

La lampadina G4 LED, dimmerabile con sistema Triac, genera una morbida luce soffusa.

- 
 SUSPENSION
- 
 WALL LAMP
- 
 CEILING LAMP
- 
 TABLE LAMP
 p.342
- 
 FLOOR LAMP



LaFleur Velvet

The stem is made of dual painted copper wires, designed to bend perfectly under the blossom.
Lo stelo, composto da 2 cavi in rame smaltato, segue la curva studiata dal designer, per conferire alla corolla/diffusore l'inclinazione perfetta.



technical details p. 546

WALL LAMP

idea

RECESSED
BY MARCANTONIO

technical details p. 542



The recessed version can be placed within drywall for a floating effect. Dimmable G9 LED bulbs make for easy substitution.

La versione Recessed può essere incassata per un effetto a scomparsa. Lampadina G9 a LED dimmerabile e facilmente sostituibile.



SUSPENSION



WALL LAMP



CEILING LAMP



TABLE LAMP
p.362



FLOOR LAMP

MAGI
CAL
EFFECTS





idea

APPLIQUE
BY MARCANTONIO

technical details p. 542



INSPIRATION COMES LIKE A LIGHTBULB GOING OFF IN YOUR HEAD

They say inspiration comes like a lightbulb going off in your head. They also say good things come in small packages. Reinventing this universal archetype required genius, folly, and sartorial expertise.

Dicono che l'ispirazione si accenda all'improvviso come una lampadina sulla testa. Dicono anche che le cose migliori arrivano in pacchetti piccoli. Reinventare questi archetipi richiede una certa dose di geniale follia e di esperienza manifatturiera.

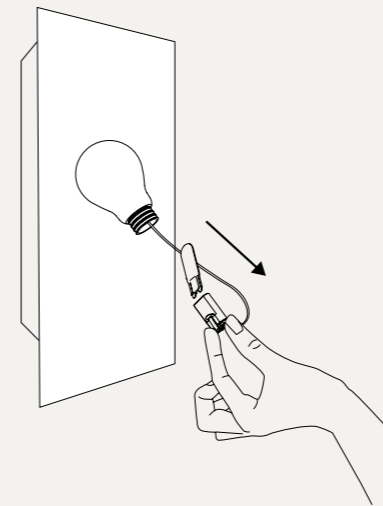

Size / Dimensione:
21 x 8,5 h. 26,5 cm
8-1/4" x 3-1/4" h. 10-1/4"



mida

BY ADRIANO RACHELE

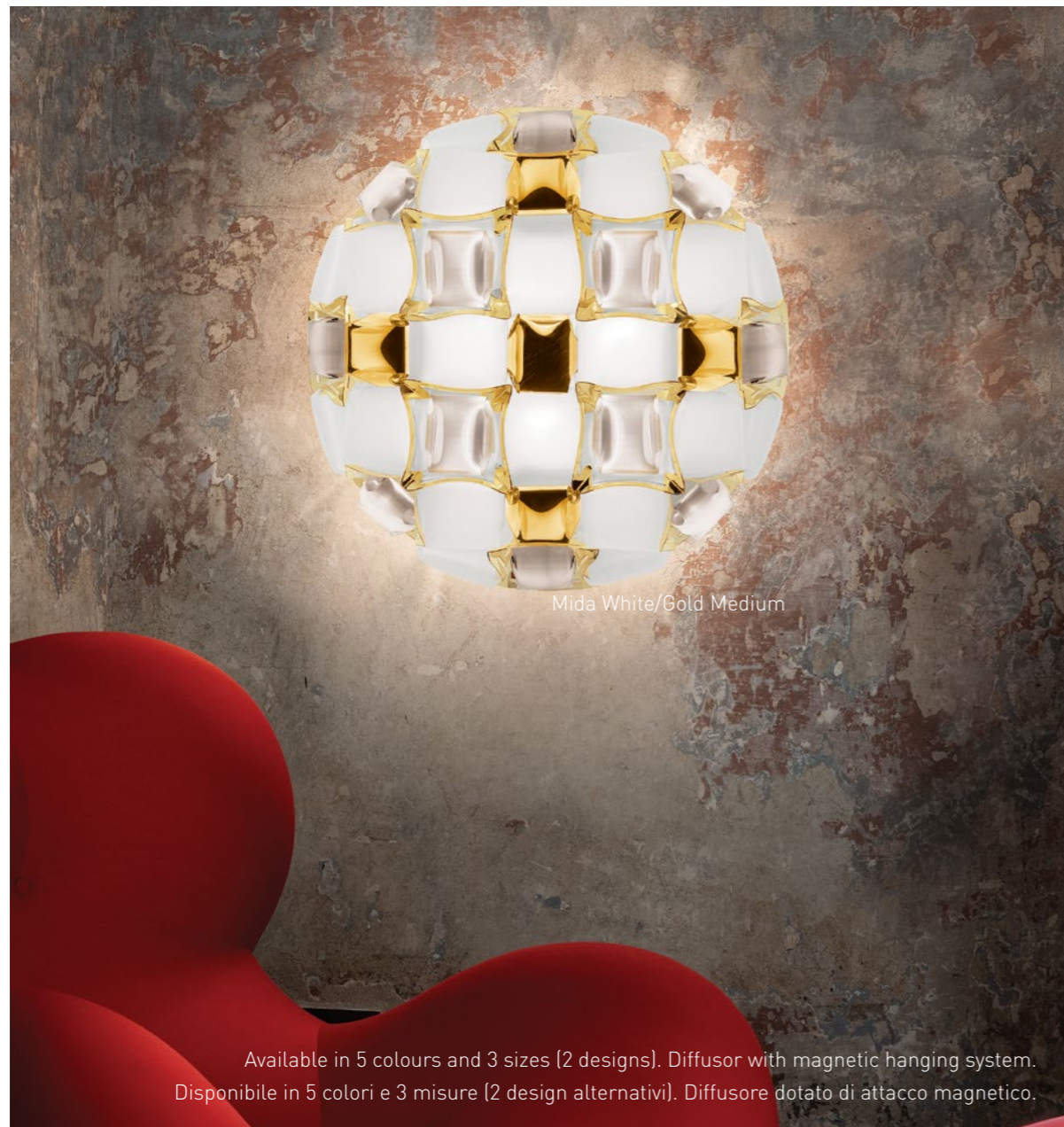

Mida White/Gold Medium

Available in 5 colours and 3 sizes (2 designs). Diffusor with magnetic hanging system.
Disponibile in 5 colori e 3 misure (2 design alternativi). Diffusore dotato di attacco magnetico.



SUSPENSION



WALL LAMP
p.448



CEILING LAMP
p.290



TABLE LAMP



FLOOR LAMP



technical details p. 548

Mida White/Platinum Large

WALL LAMP



Mida Multicolor Medium

Mida is a ceiling/wall lamp with our exclusive magnetic system for easy installation and maintenance, inspired by polished cabochon geometrically placed across a floral corolla with silky, iridescent stones.

Dotata di attacco magnetico per una facile installazione e semplice manutenzione, Mida si ispira ai cabochon lisci e levigati che si dispongono in maniera ordinata a disegnare la corolla di un fiore dai colori cangianti e setosi.



Mida Rose Medium

Mida amber detail

Size / Dimensioni:
L: Ø67 cm x h. 21 cm
Ø26" x 8-1/4"
M: Ø50 cm x h. 16 cm
Ø19" x 6-1/4"

mida

APPLIQUE
BY ADRIANO RACHELE



Mida Applique Amber

Size / Dimensioni:
Ø32 cm x h. 12 cm - Ø12 -1/2" x h. 4-1/2"

4 coloured gems and 5 metallic gems / 4 gemme colorate e 5 metallizzate.



SUSPENSION



WALL LAMP
p.444



CEILING LAMP
p.290



TABLE LAMP



FLOOR LAMP

INSPIRED BY
CABO
CHON

hanami

BY ADRIANO RACHELE

technical details p. 539



Size / Dimensione:
Ø65 x h. 21 cm - 25-1/2" x h. 8-1/4"

Lighting / Illuminazione:
7 x 5W G9 LED Dimmable Bulbs

SUSPENSION
p.210

WALL LAMP



CEILING LAMP
p.306

TABLE LAMP

FLOOR LAMP

la belle étoile

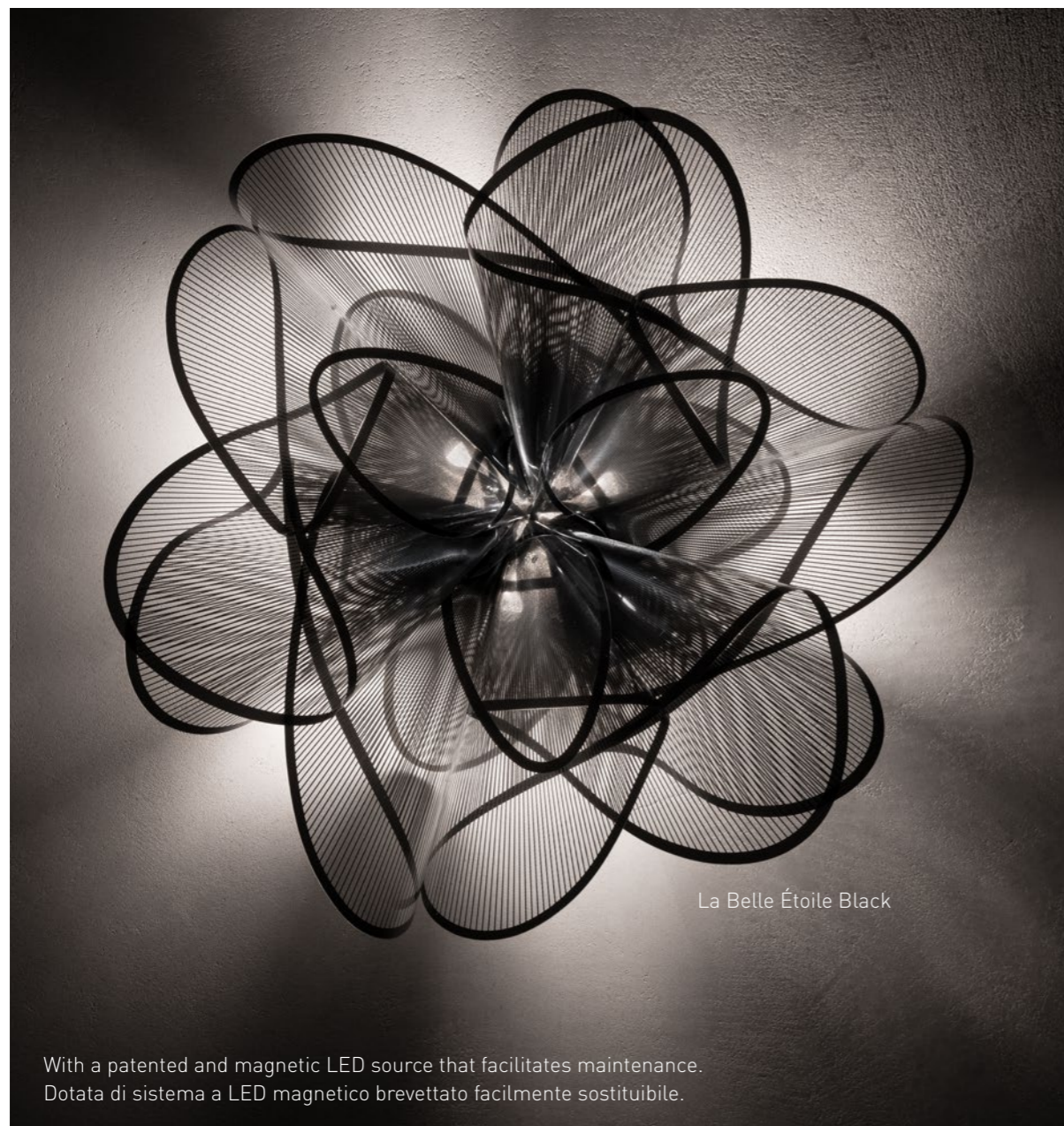
BY ADRIANO RACHELE



La Belle Étoile Black

With a patented and magnetic LED source that facilitates maintenance.
Dotata di sistema a LED magnetico brevettato facilmente sostituibile.



SUSPENSION
p.126



WALL LAMP



CEILING LAMP
p.308



TABLE LAMP



FLOOR LAMP

technical details p. 543



La Belle Étoile White

WALL LAMP

étoile

BY ADRIANO RACHELE

technical details p. 535



Size / Dimensioni:
Ø73 cm x h. 23 cm - Ø28-1/2" x 8-3/4"
Integrated Magnetic System and changeable LED source.
Dotata di Attacco Magnetico e sistema LED sostituibile.



Prisma detail

Lighting/Illuminazione:
LED 15W - 220~240 Vac / 40 Vdc - 2150
Lumen 2700 K (warm white) - CRI 90

-  SUSPENSION
p.134
-  WALL LAMP
-  CEILING LAMP
p.310
-  TABLE LAMP
-  FLOOR LAMP

fabula

BY COSTANTINO MOROSIN

technical details p. 536

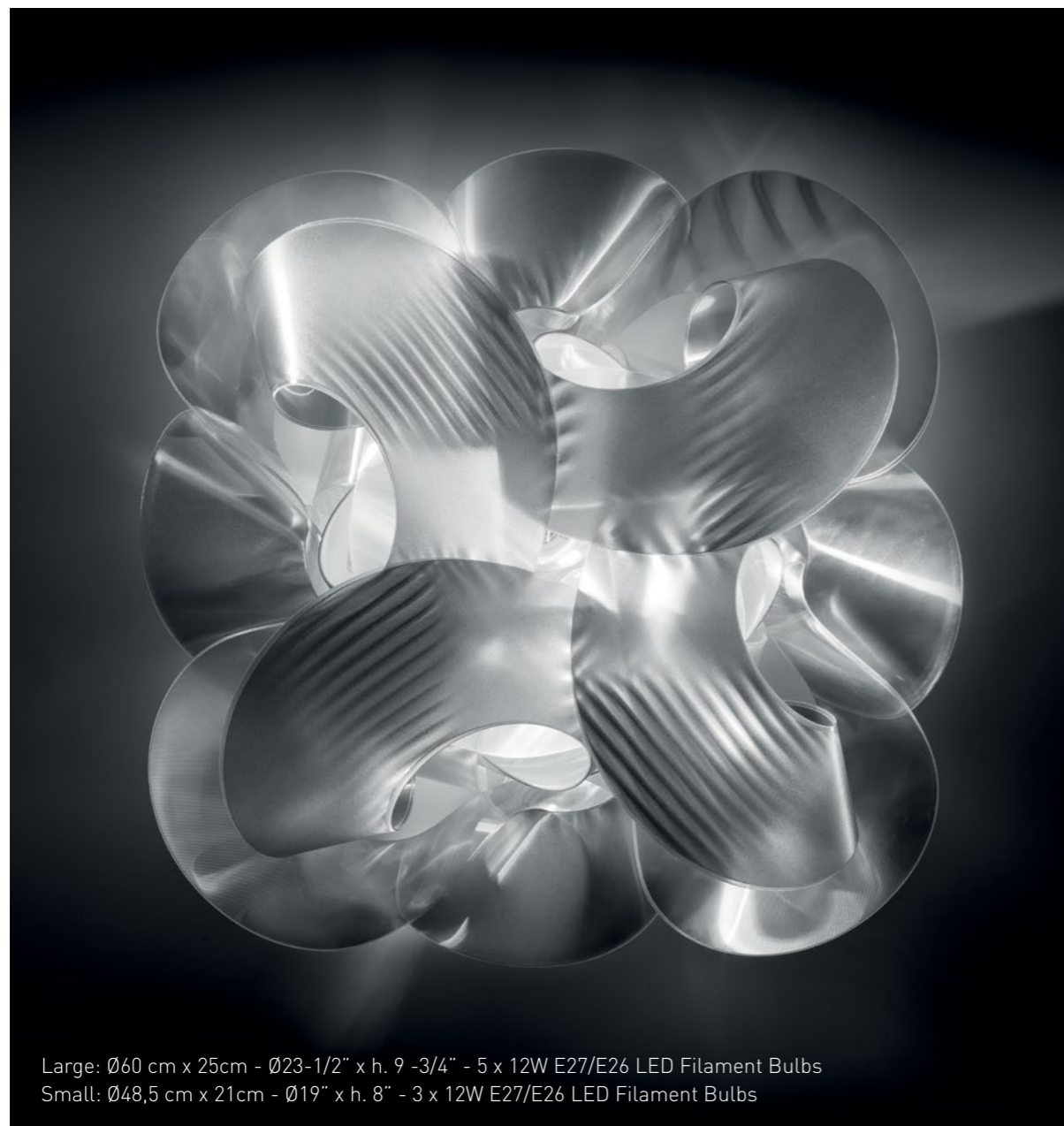

Large: Ø60 cm x 25cm - Ø23-1/2" x h. 9 -3/4" - 5 x 12W E27/E26 LED Filament Bulbs
Small: Ø48,5 cm x 21cm - Ø19" x h. 8" - 3 x 12W E27/E26 LED Filament Bulbs

-  SUSPENSION
p.216
-  WALL LAMP
-  CEILING LAMP
p.312
-  TABLE LAMP
-  FLOOR LAMP

SILKY

FABRIC

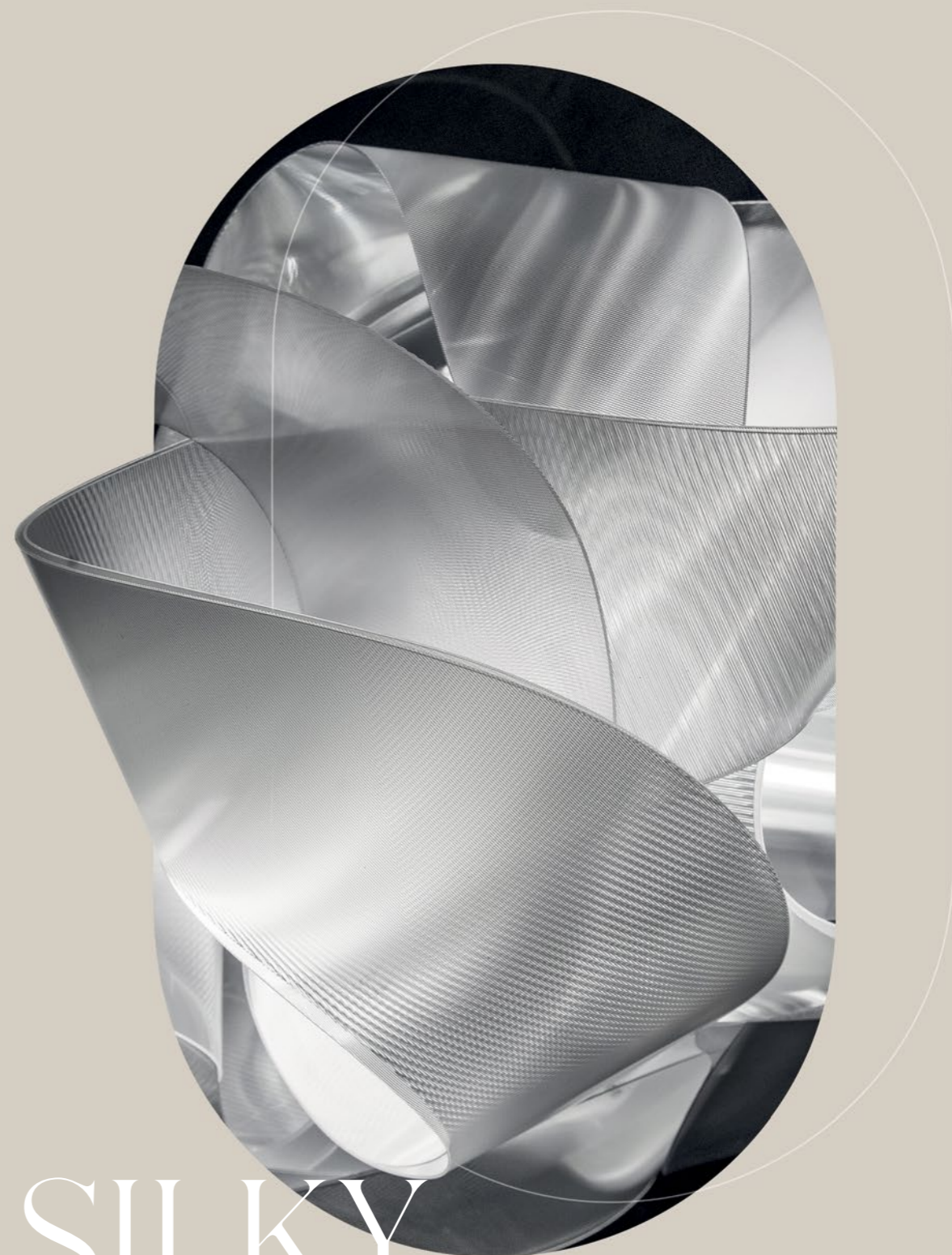

drusa

BY ADRIANO RACHELE



Drusa Velvet



SUSPENSION
p.230

WALL LAMP

CEILING LAMP
p.282

TABLE LAMP

FLOOR LAMP

technical details p. 534



Drusa White

Size / Dimensioni:
Ø60 cm x h. 20 cm - Ø23-1/2" x h. 8"

Lighting / Illuminazione:
4 x 12W E27/E26 LED Filament Bulbs

bios

BY NIGEL COATES

technical details p. 526



WALL LAMP

- 
 SUSPENSION
- 
 WALL LAMP
- 
 CEILING LAMP
 p.314
- 
 TABLE LAMP
- 
 FLOOR LAMP
 p.504

dafne

BY NIGEL COATES



SUSPENSION
p.250

WALL LAMP

CEILING LAMP
p.318

TABLE LAMP

FLOOR LAMP
p.506

META



MORPHIC LIGHT

fiorella

BY NIGEL COATES

technical details p. 537



Size / Dimensioni:
34 x 22 x h.19 cm
13-1/2" x 8-3/4" x h. 7-1/2"

SUSPENSION
p.242

WALL LAMP

CEILING LAMP

TABLE LAMP
p.380

FLOOR LAMP

venti

BY ALESSANDRO MENDINI



Available in 3 dimensions / Disponibile in 3 dimensioni:
Large: Ø72 x h. 15 cm - Ø28-1/4" x h. 6"; Medium: Ø54 x h. 12 cm - Ø21-1/4" x h. 4-3/4"
Small: Ø36 x h. 8,5 cm - Ø14-1/4" x h. 3-1/4"



SUSPENSION



WALL LAMP



CEILING LAMP
p.320



TABLE LAMP



FLOOR LAMP
p.514



medusa

BY NIGEL COATES

technical details p. 548

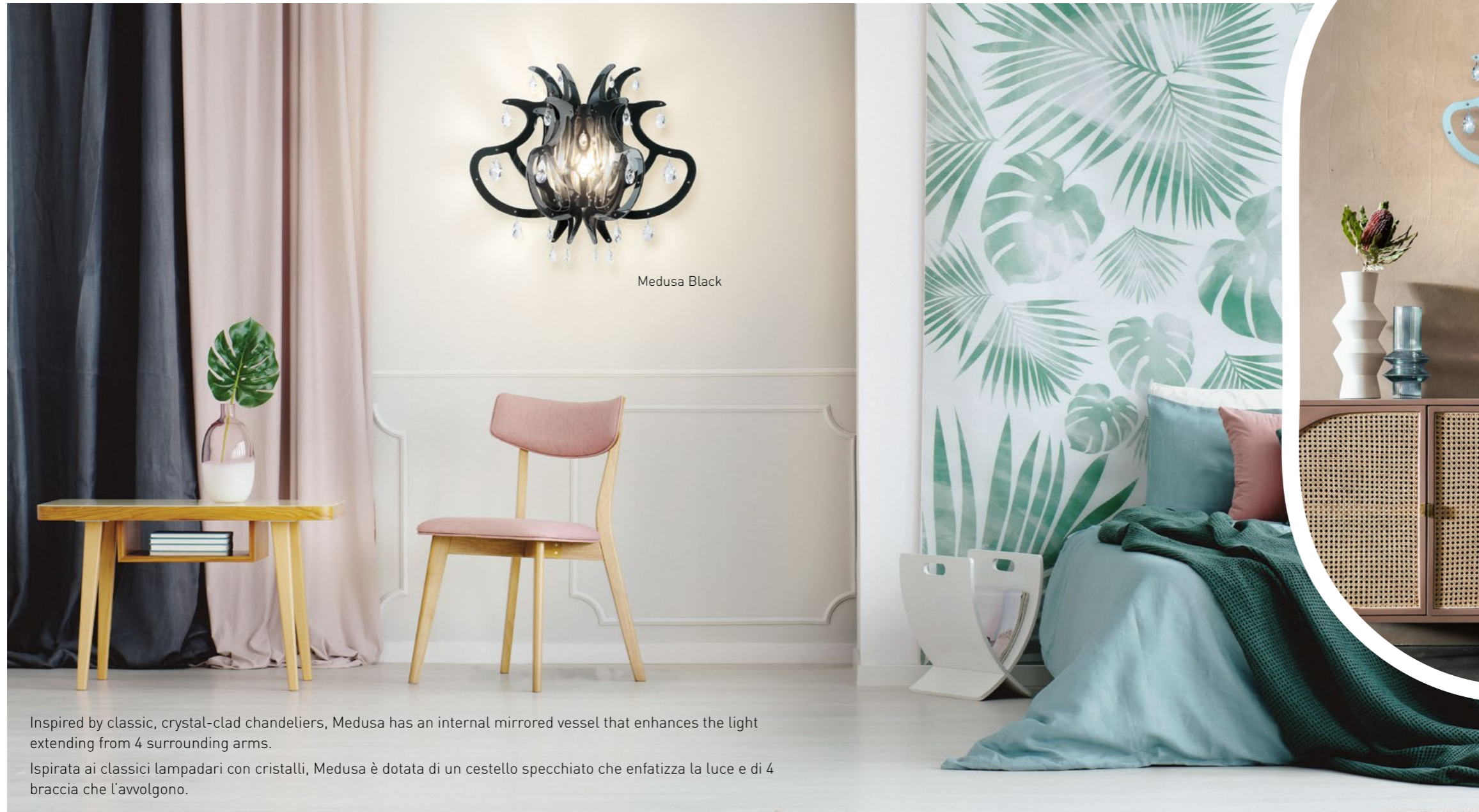

Medusa Black

Medusa Blue Gel

Inspired by classic, crystal-clad chandeliers, Medusa has an internal mirrored vessel that enhances the light extending from 4 surrounding arms.

Ispirata ai classici lampadari con cristalli, Medusa è dotata di un cestello specchiato che enfatizza la luce e di 4 braccia che l'avvolgono.

-  SUSPENSION
p.246
-  WALL LAMP
-  CEILING LAMP
-  TABLE LAMP
-  FLOOR LAMP

lilibet

BY NIGEL COATES

technical details p. 547



Lilibet Transparent



Lilibet White

The radial structure easily connects to the central Cristalflex® cylinder, reflecting Lilibet's luxurious transparent crystals.

Lilibet è realizzata con una struttura radiale che si aggancia facilmente al cestello centrale in Cristalflex®.

- 
 SUSPENSION
 p.224
- 
 WALL LAMP
- 
 CEILING LAMP
- 
 TABLE LAMP
- 
 FLOOR LAMP

FLOOR

LAMPS

SLAMP:

modula

BY ELISA GIOVANNONI



Modula Twisted Light Gray - Crystal



SUSPENSION
p.152



WALL LAMP



CEILING LAMP



TABLE LAMP



FLOOR LAMP



Lighting /Illuminazione:
LED: 70W - 100-240Vac/24Vdc
7.542 lumen - 3000 Kelvin - Dimmable
Pictured: Modula Twisted Black - Plissé

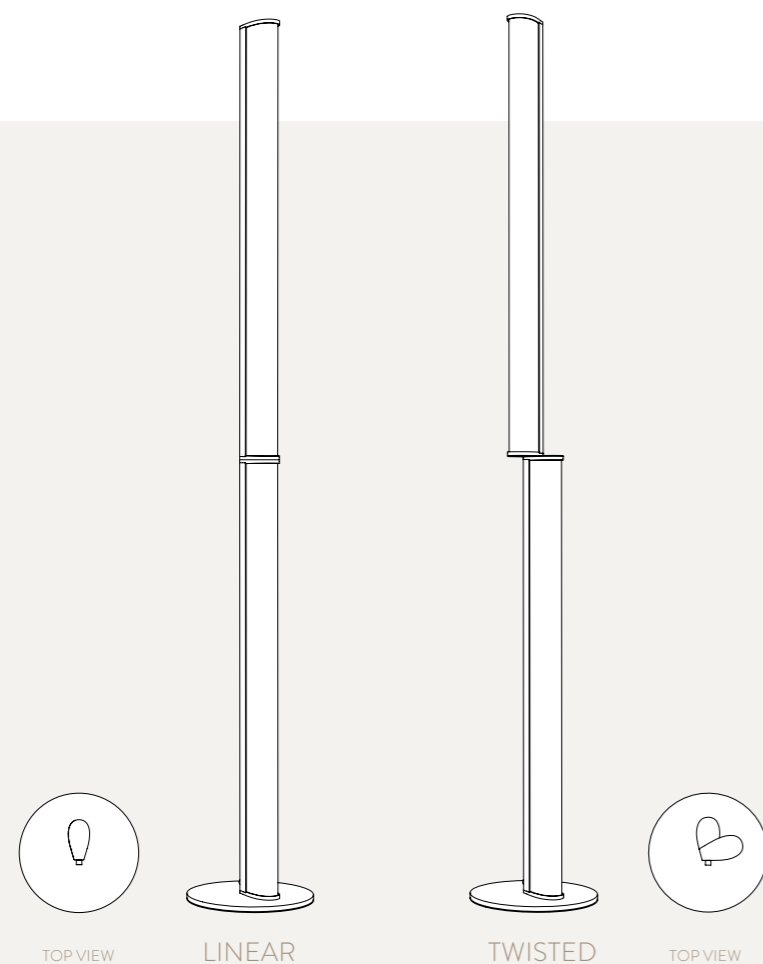

TWISTED OR LINEAR?

The lamp is available in both pre-positioned linear and slightly rotated versions. The full structure (profile and base) is available in light grey or black shades. The dimmable source is housed in a Lentiflex® diffuser available in two effects: Plissé or Crystal.

La lampada è disponibile in una versione lineare e una leggermente ruotata, entrambe fisse. La struttura (profili e base) è disponibile in grigio chiaro o nero. È possibile scegliere fra due effetti luminosi del diffusore in Lentiflex®, entrambi dimmerabili, Plissé e Crystal.

Size / Dimensioni:

Base: Ø30 cm (Ø11-3/4") - Diffusor: 10 x h.194 cm (4" x h.75-3/4")



Even illumination runs throughout the floor lamp's structure.

Una linea di luce omogenea corre lungo tutta la dorsale della piantana.

Modula Twisted Black - Plissé

PLISSÉ



The Plissé effect recreates illuminated spiraling columns often used in architecture.
L'effetto "Plissé" ricrea con la luce il disegno a spirale delle colonne tortili utilizzate in architettura.

CRYSTAL



The Crystal effect casts a sophisticated, shining jewel-like effect over a soft surface.
L'effetto Crystal ricorda un'impuntura di strass su una superficie morbida, ricreando un effetto brillante e sofisticato.

la lollo

BY LORENZA BOZZOLI

technical details p. 544



La Lollo Gold



La Lollo Silver detail

Size / Dimensioni:
Base: Ø29 cm - Ø11-1/4"
Diffusor: Ø13 x h. 163 cm
Ø5" x h. 63-1/2"

-  SUSPENSION
p.180
-  WALL LAMP
p.400
-  CEILING LAMP
-  TABLE LAMP
-  FLOOR LAMP

UNBREAKABLE AND HIGHLY SOPHISTICATED

An elegant, refined column that resembles blown glass from Murano: high tech, unbreakable, easily transported, and highly sophisticated.

Una colonna di luce elegante e raffinata, che ricorda la trama del vetro cannettato della tradizione muranese in una versione high-tech, infrangibile, facilmente trasportabile e sofisticata.

Size / Dimensioni:

Base: Ø29 cm - Ø11-1/4"

Diffusor: Ø13 x h. 163 cm - Ø5" x h. 63-1/2"

12W LED FILAMENT BULB

12W LED FILAMENT BULB

12W LED FILAMENT BULB



WEIGHT
LESS
ABUNDANCE



bach

BY FRANCESCO PARETTI



-  SUSPENSION
-  WALL LAMP
-  CEILING LAMP
-  TABLE LAMP
p.384
-  FLOOR LAMP



STATUARY
ELEGANCE



Bach is statuary, with elegant yet rigorous curves, bringing fluid, linear movement and illumination to any interior. Bach è uno corpo statuario e dalle tinte chiare. Le sue eleganti ma rigorose forme si legano alle moderne curvature capaci di seguire perfettamente le linee di ogni ambiente.



Size / Dimensioni:
XXL: Ø31,5 cm x h. 184 cm
Ø12-1/2" x h. 72-1/2";
XL: Ø31,5 cm x h. 161 cm
Ø12-1/2" x h. 63-1/2"

the lightning archives

OF STUDIO JOB



Love Peace Joy



Perished

-  SUSPENSION
-  WALL LAMP
-  CEILING LAMP
-  TABLE LAMP
-  FLOOR LAMP



technical details p. 552

ICONOGRAPHIC GRAMMAR

Faena Art

FLOOR LAMP



Bananas

Labyrinth

L' Afrique

Love Peace Joy

Faena Art

Perished



Peace Skull

Size / Dimensioni:
37 x 21 x h. 160 cm
14-1/2" x 8-1/4" x h. 62"

hugo

BY SLAMP CREATIVE DEPARTMENT

technical details p. 541



2021 HONORABLE MENTION
**EUROPEAN
PRODUCT
DESIGN
AWARD**

Size / Dimensioni:
9 x h. 207 cm, base Ø32 cm
3-1/2" x h. 80-3/4", base Ø12-1/2"



SUSPENSION
p.106



WALL LAMP



CEILING LAMP



TABLE LAMP



FLOOR LAMP



FLOOR LAMP



Soft touch dimming system (0-100) with ergonomically placed button.
Sistema di dimmerazione 0-100 con pulsante soft touch in posizione ergonomica



The design and bend of the floor lamp were inspired by the outreached hands of Michelangelo's "Last Judgement" in the Sistine Chapel. The light touch dimming system is ergonomically placed, and blinks when the lamp is at minimum and maximum brightness.

L'inclinazione e il design della lampada da terra sono ispirati al tocco delle mani dei protagonisti del Giudizio Universale, il dipinto di Michelangelo nella Cappella Sistina. Il sistema di dimmerazione a sfioramento, collocato in posizione ergonomica, lampeggia quando raggiunge il punto massimo e minimo d'intensità luminosa.

cactus

GOLD
BY ADRIANO RACHELE

technical details p. 527



Hand-inserted folds transform into an ironic, irreverent lamp, available in two floor and two table sizes.

Incastri eseguiti a mano per una lampada ironica e irriverente disponibile in 2 misure da terra e 2 da tavolo.

SUSPENSION
p.232

WALL LAMP

CEILING LAMP

TABLE LAMP
p.388

FLOOR LAMP

cactus

PRISMA
BY ADRIANO RACHELE

technical details p. 527



Cactus XXL



Size / Dimensioni:
Ø28 x h 155 cm - Ø11" x h. 61"

Lighting / Illuminazione:
2 x 12W E27/E26
LED Filament bulbs



flora

BY ZANINI DE ZANINE

technical details p. 537



Flora Gold



3X12W LED FILAMENT BULBS

Size / Dimensioni:
 Ø50 cm x h. 170 cm - Ø19-3/4" x h. 67"

Flora Pewter

- 
 SUSPENSION
 p.214
- 
 WALL LAMP
- 
 CEILING LAMP
- 
 TABLE LAMP
- 
 FLOOR LAMP



Flora White

Sixty petals surround a satin sphere illuminated from its core. The lamp is available in both a suspension as well as floor version resting on thin legs that resemble a flower's pistils.

60 petali avvolgono la sfera satinata, cuore lucente della lampada disponibile sia in versione a sospensione, che nella versione da terra dotata di sottili steli che ricordano i pistilli di un fiore.



INSPIRED BY THE
MONSTERA
DELICIOSA PLANT

bios

BY NIGEL COATES

technical details p. 527



Diamond Small

- 
 SUSPENSION
- 
 WALL LAMP
 p.460
- 
 CEILING LAMP
 p.314
- 
 TABLE LAMP
- 
 FLOOR LAMP



Bios has two layers of Opalflex®, both with carefully selected incisions that let the light shine through, creating suggestive reflections and shadows.

Bios nasce dalla sovrapposizione di due strati di Opalflex® dai quali, attraverso i fori irregolari, filtra una luce che crea suggestivi giochi di luci e di ombre.

dafne

BY NIGEL COATES



Size / Dimensioni:
37 x 21 x h. 160 cm - 14-1/2" x 8-1/4" x h. 63"

-  SUSPENSION
p.250
-  WALL LAMP
p.462
-  CEILING LAMP
p.318
-  TABLE LAMP
-  FLOOR LAMP



META MORPHIC LIGHT

las palmas

BY PAOLUCCI
STATERA

technical details p. 546

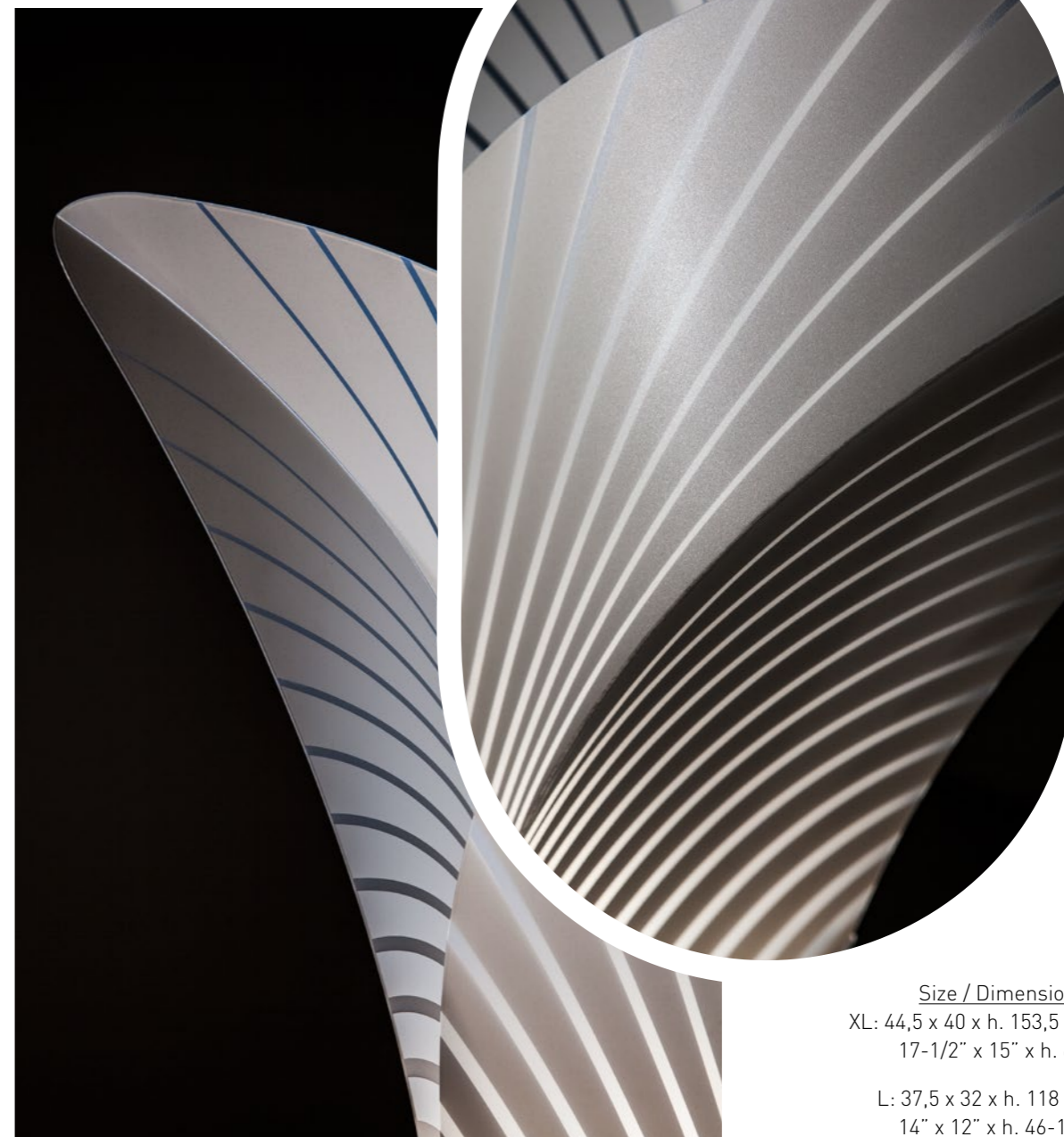

Size / Dimensione:
 XL: 44,5 x 40 x h. 153,5 cm
 17-1/2" x 15" x h. 60"
 L: 37,5 x 32 x h. 118 cm
 14" x 12" x h. 46-1/2"

- 
 SUSPENSION
- 
 WALL LAMP
- 
 CEILING LAMP
- 
 TABLE LAMP
 p.396
- 
 FLOOR LAMP

ecstacity

BY NIGEL COATES

technical details p. 534

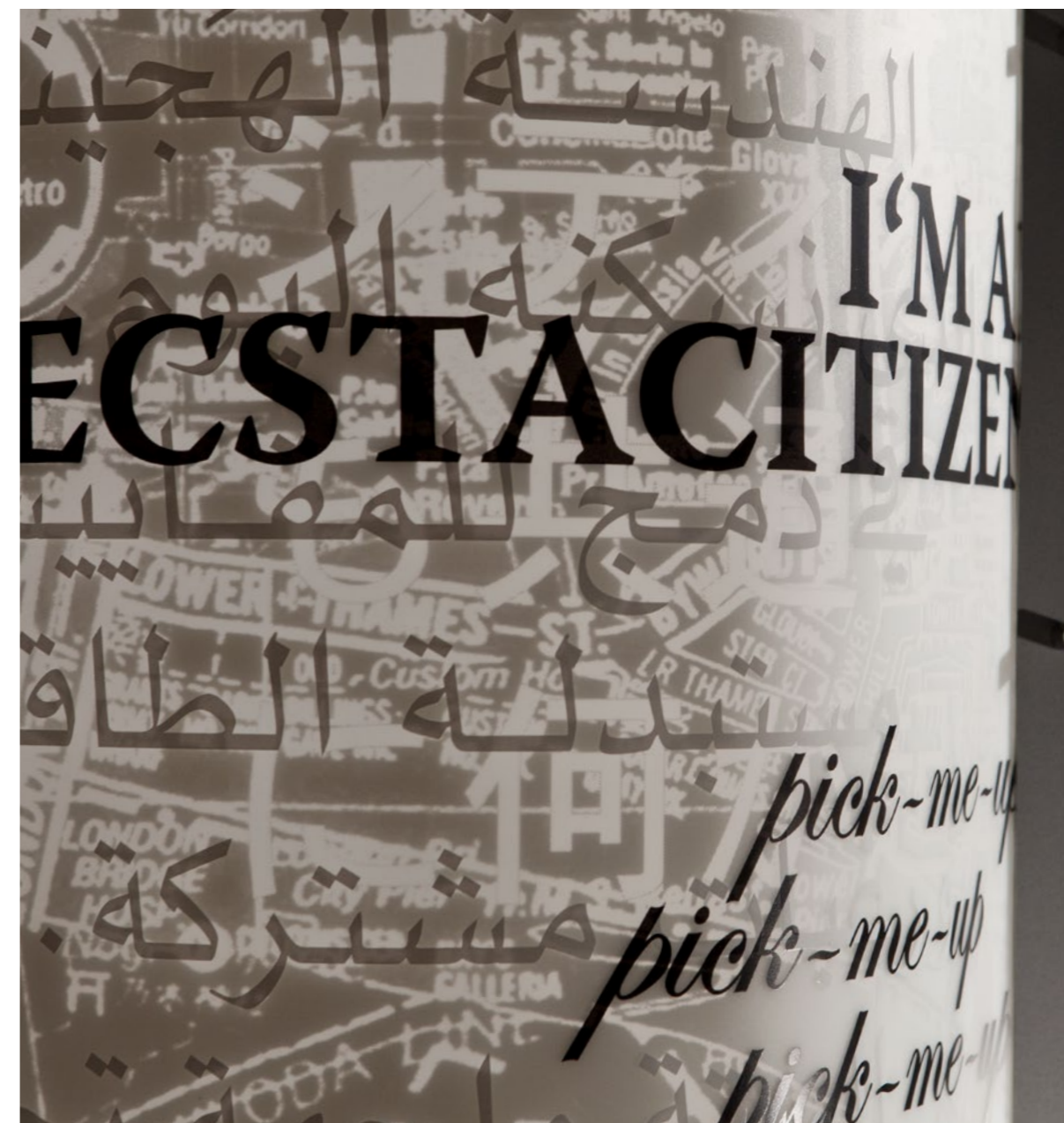

Aluminium sides. Dimmer included / Profili in alluminio. Dimmer incluso.
 Size/Dimensioni: 37 x 21 x h. 160 cm - 14-1/2" x 8-1/4" x h. 63"



SUSPENSION WALL LAMP CEILING LAMP TABLE LAMP FLOOR LAMP

diamond

BY PAOLUCCI / STATERA

technical details p. 533



Diamond's geometric design allows the light to accentuate its various facets and angles.

Diamond ha un design geometrico che, incontrando la luce, ne accentua le forme sfaccettate.



SUSPENSION



WALL LAMP



CEILING LAMP



TABLE LAMP
p.390



FLOOR LAMP

venti

BY ALESSANDRO MENDINI

technical details p. 558



Aluminium sides and dimmer included. - Profili in alluminio e dimmer incluso.

Size/Dimensioni: 37 x 21 x h. 160 cm - 14-1/2" x 8-1/4" x h. 63"



atlante

BY NIGEL COATES



Lighting / Illuminazione: 8 X 15W max
E14/E12 IBC/C bulbs



SUSPENSION
p.234



WALL LAMP



CEILING LAMP



TABLE LAMP



FLOOR LAMP

AN
ILLU
MINA
TED
ATLAS





TECHNICAL details

SLAMP:

ACCORDÉON SUSPENSION

LED: 52W 100 ~ 240V - 5.900 Lumen

2700 Kelvin or 3000 Kelvin

220V version dimmable with PWM / 0-10

110V version Dimmable with: Triac

Additional dimming system Dali, Bluetooth, Casambi, Triac upon request

MADE OF: Lentiflex® / Goldflex® / Steelflex®

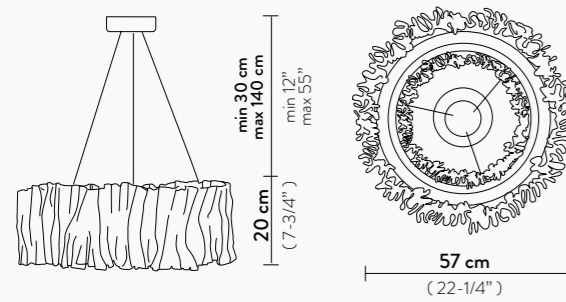

COLOURS:

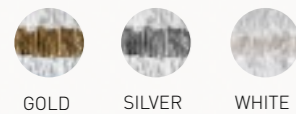

ACCORDÉON VERTICAL SUSPENSION

1 X 10W LED Filament Bulb E14/E12

Dimmable with dimmable bulbs (max dim.Ø5 cm - 2")

MADE OF: Lentiflex® / Brushed Goldflex®

WITH: Hand molded diffuser, black wrapped electric wire

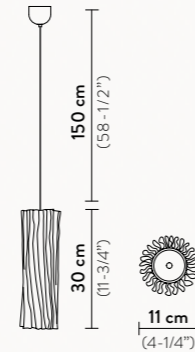

COLOURS:

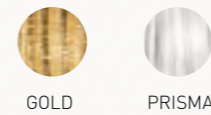

ARIA APPLIQUE

2 X 6W LED Filament Bulbs E14/E12

+ 1 X 6W Spot LED Bulb E14/E12

Dimmable with dimmable bulbs

MADE OF: Cristalflex® and Lentiflex®

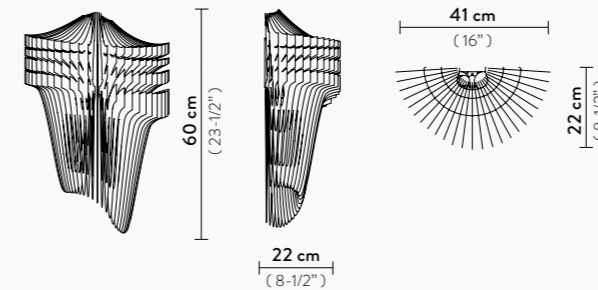

COLOURS:

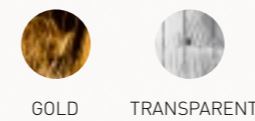

ARIA SUSPENSION XL

6 X 12W LED Filament Bulbs E27/E26

+ 1 X 11W Spot LED Par 30 E27/E26

Dimmable with dimmable bulbs

MADE OF: Cristalflex® and Lentiflex®

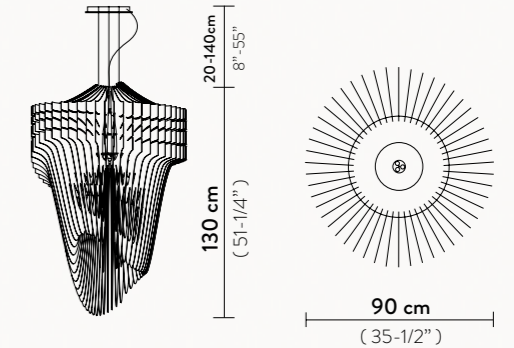

COLOURS:

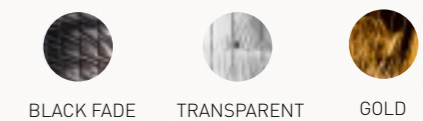

ACCORDÉON TABLE

2 X 12W LED Filament Bulbs E27/E26

+ 1 X 6W LED Filament Bulbs E14/E12

MADE OF: Lentiflex® / Cristalflex®

WITH: Two Position Light Switch - Magnetic System®

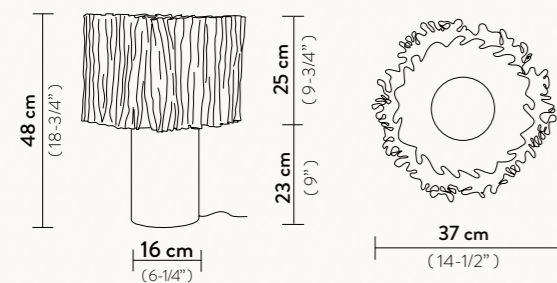

COLOURS:



ACCORDÉON BATTERY TABLE

LED: 1.3W dimmable- 150 Lumen - 2700 Kelvin

Rechargeable Li-ion Polymer Cell 3.7 Vdc 2500mAh Charge 5 Vdc 1A.

BATTERY DURATION: at max intensity around 6.5 hours duration, at min intensity around 60 hours duration.

MADE OF: Lentiflex®, Anodized aluminium

USB Multicharger station (20 ports) upon request

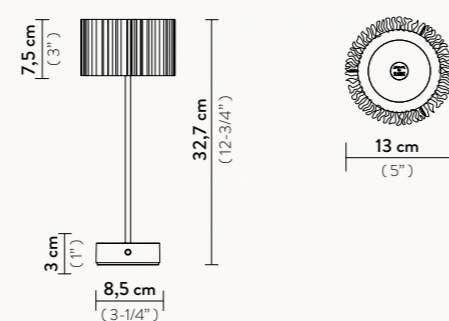

COLOURS:

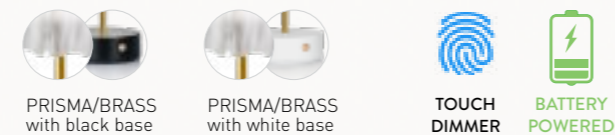

ARIA SUSPENSION L

4 X 12W LED Filament Bulbs E27/E26

+ 1 X 11W Spot LED Par 30 E27/E26

Dimmable with dimmable bulbs

MADE OF: Cristalflex® / Lentiflex®

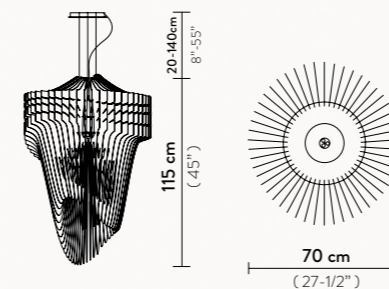

COLOURS:

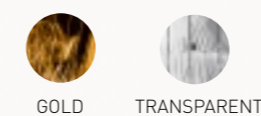

ARIA SUSPENSION M

3 X 12W LED Filament Bulbs E27/E26

+ 1 X 7W Spot LED Par 20 E27/E26

Dimmable with dimmable bulbs

MADE OF: Cristalflex® / Lentiflex®

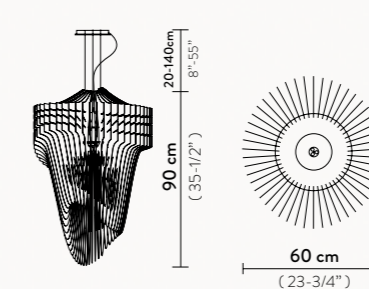

ARIA SUSPENSION S

2 X 12W LED Filament Bulbs E27/E26

+ 1 X 7W Spot LED Par 20 E27/E26

Dimmable with dimmable bulbs

MADE OF: Cristalflex® / Lentiflex®

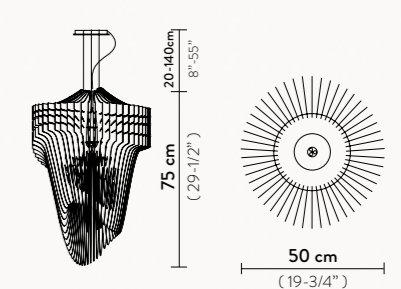

ARIA INFINITA SUSPENSION

The Slamp Team can customize solutions to any space, working alongside designers.

Il team di Slamp è pronto ad offrire soluzioni su misura, lavorando a quattro mani con il progettista e sulla base delle caratteristiche dello spazio da allestire.

3 ARRANGEMENTS SHOW SLAMP & ZAHA HADID STUDIO PRODUCT'S DECOR POSSIBILITIES

ARIA INFINITA ARRANGEMENT 1

30 X 12W LED Filament Bulbs + 8 x 12W Spot LED Par 38



ARIA INFINITA ARRANGEMENT 2

54 X 12W LED Filament Bulbs + 14 x 12W Spot LED Par 38

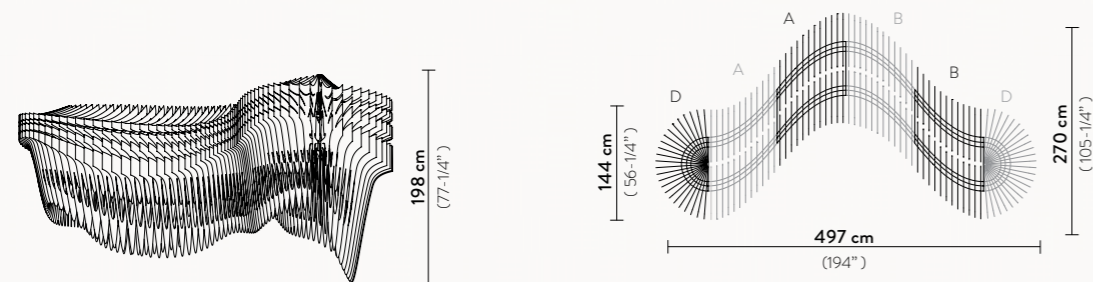

ARIA INFINITA ARRANGEMENT 3

78 X 12W LED Filament Bulbs + 22 x 12W Spot LED Par 38

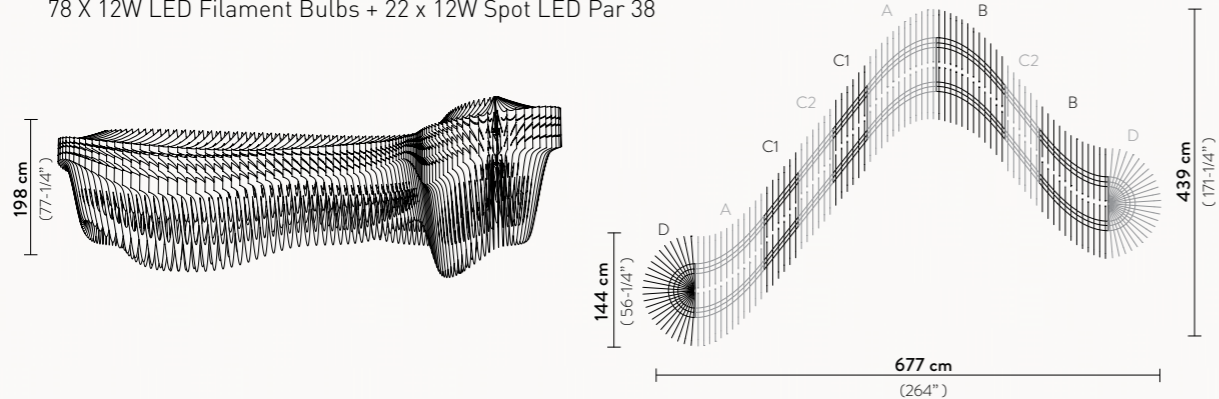

ATLANTE SUSPENSION

8 X 15W max IBC/C Bulbs E14/E12

MADE OF: Cristalflex®

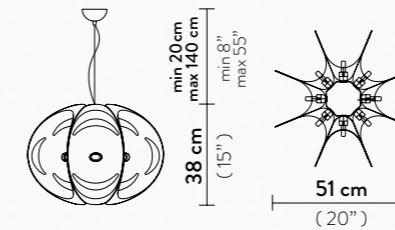

COLOURS:



FUMÉ

ATLANTE FLOOR

8 X 15W max IBC/C Bulbs E14/E12

MADE OF: Cristalflex®

WITH: Stainless Steel structure

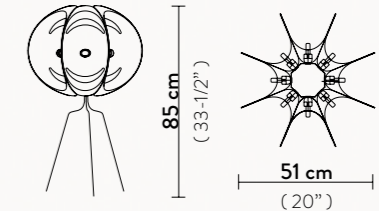

COLOURS:



FUMÉ

ATMOSFERA SUSPENSION

2 X 12W LED Filament Bulbs E27/E26

Dimmable with dimmable bulbs

MADE OF: Methacrylate / Goldflex®

or Pewterflex® / Lentiflex®

WITH: Hand - finished Sphere

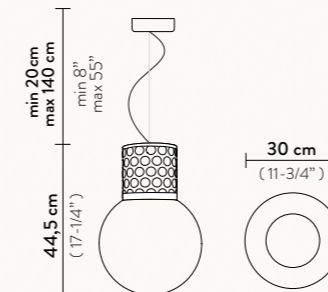

COLOURS:



GOLD



PEWTER

ATMOSFERA TABLE MEDIUM

2 X 12W LED Filament Bulbs E27/E26

MADE OF: Methacrylate / Goldflex®

or Pewterflex® / Lentiflex®

WITH: Hand - finished Sphere

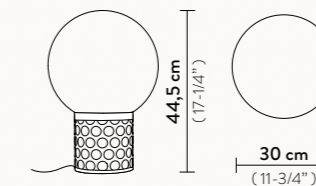

COLOURS:



GOLD



PEWTER

ATMOSFERA TABLE SMALL

2 X 6 W LED Bulbs G9

MADE OF: Methacrylate / Goldflex®

or Pewterflex® / Lentiflex®

WITH: Hand - finished Sphere

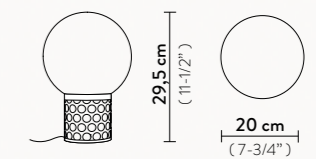

2 INDEPENDENT LIGHT SOURCES

AURORA CEILING LARGE

1 X 12W LED Filament Bulb E27/E26
Dimmable with dimmable bulbs
MADE OF: Plainflex® / 97 Crystals
WITH: Magnetic System®

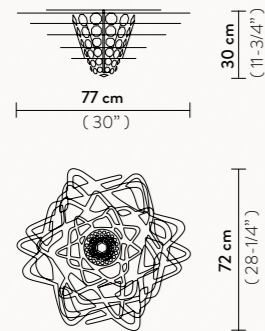

COLOURS:

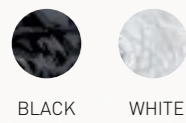

AURORA CEILING MINI

1 X 12W LED Filament Bulb E27/E26
Dimmable with dimmable bulbs
MADE OF: Plainflex® / 61 Crystals
WITH: Magnetic System®

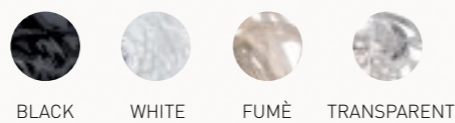
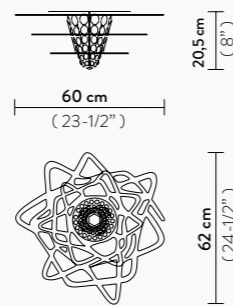

AVIA SUSPENSION S

2 X 12W LED Filament Bulbs E27/E26
+ 1 X 7W Spot LED Par 20 E27/E26
Dimmable with dimmable bulbs
MADE OF: Cristalflex® / Lentiflex®

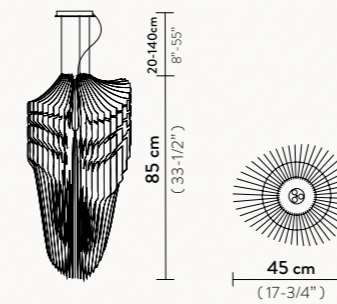

COLOURS:

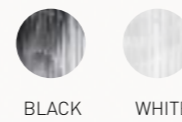

AVIA EDITION M

3 X 12W LED Filament Bulbs E27/E26
+ 1 X 7W Spot LED Par 20 E27/E26
Dimmable with dimmable bulbs
MADE OF: Cristalflex® / Lentiflex®

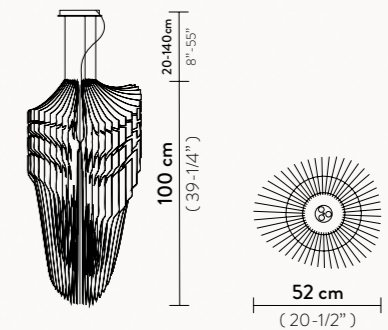

COLOURS:

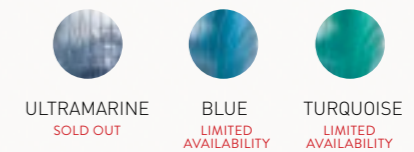

AVIA SUSPENSION XL

6 X 12W LED Filament Bulbs E27/E26
+ 1 X 11W Spot Par 30 E27/E26
Dimmable with dimmable bulbs
MADE OF: Cristalflex® / Lentiflex®

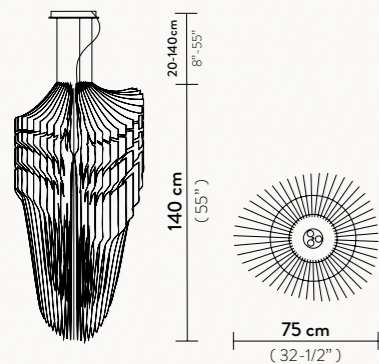

COLOURS:

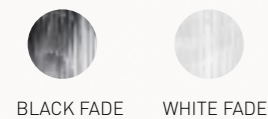

AVIA SUSPENSION L

4 X 12W LED Filament Bulbs E27/E26
+ 1 X 11W Spot Par 30 E27/E26
Dimmable with dimmable bulbs
MADE OF: Cristalflex® / Lentiflex®

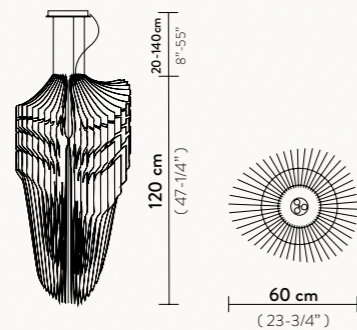

AVIA SUSPENSION M

3 X 12W LED Filament Bulbs E27/E26
+ 1 X 7W Spot LED Par 20 E27/E26
Dimmable with dimmable bulbs
MADE OF: Cristalflex® / Lentiflex®

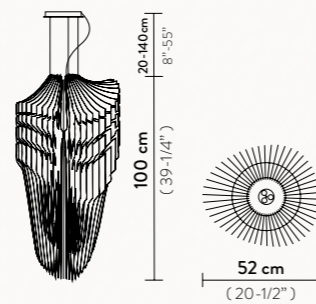

BACH FLOOR XXL

3 X 12W LED Filament Bulbs E27/E26
MADE OF: Opalflex®
WITH: Stainless Steel base - Dimmer

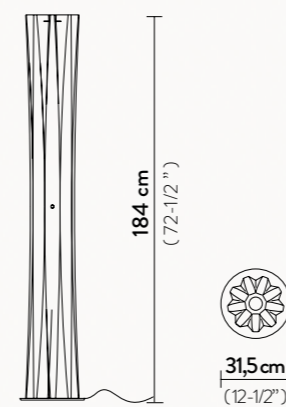

COLOURS:

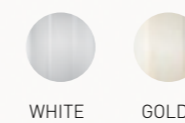

BACH FLOOR XL

3 X 12W LED Filament Bulbs E27/E26
MADE OF: Opalflex®
WITH: Stainless Steel base - Dimmer

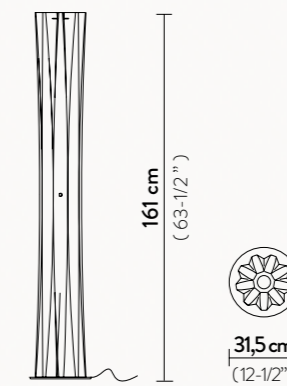

BACH FLOOR L

2 X 12W LED Filament Bulbs E27/E26
MADE OF: Opalflex®
WITH: Stainless Steel base

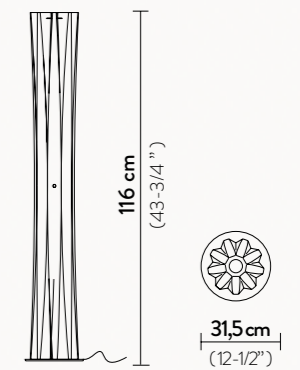

BACH TABLE M

1 X 12W LED Filament Bulb E27/E26
MADE OF: Opalflex®
WITH: Stainless Steel base

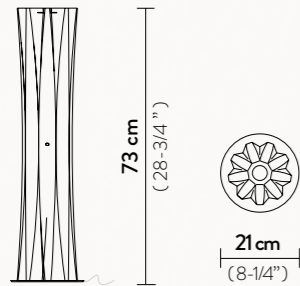

BACH TABLE S

1 X 6W LED Filament Bulb E14/E12
MADE OF: Opalflex®
WITH: Stainless Steel base

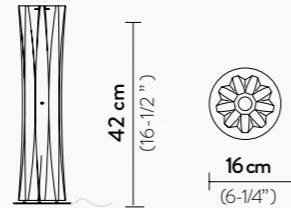

COLOURS:

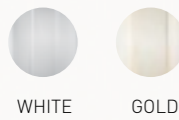

BIOS FLOOR

3 X 12W LED Filament Bulbs E27/E26
MADE OF: Opalflex®
WITH: Dimmer

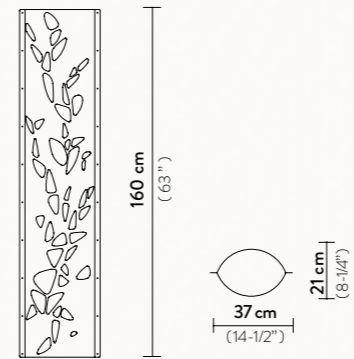

COLOURS:

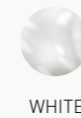

CACTUS SUSPENSION

1 X 12W LED Filament Bulb E27/E26
Dimmable with dimmable bulbs
MADE OF: Opalflex®

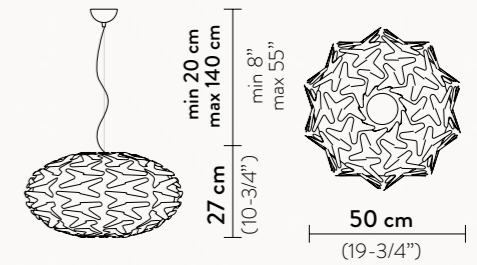

COLOURS:

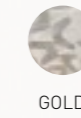

BIOS CEILING/WALL L

4 X 12W LED Filament Bulbs E27/E26
Dimmable with dimmable bulbs
MADE OF: Opalflex®
WITH: Magnetic System®
(Bayonet mount for North America)

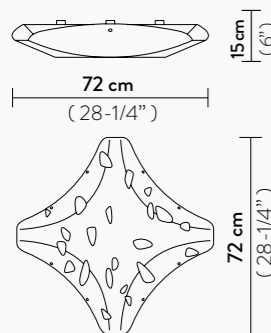

BIOS CEILING/WALL M

3 X 12W LED Filament Bulbs E27/E26
Dimmable with dimmable bulbs
MADE OF: Opalflex®
WITH: Magnetic System®

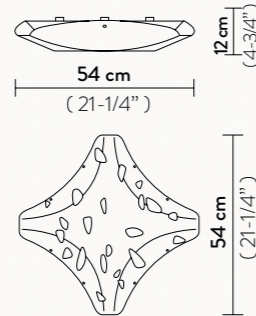

BIOS CEILING/WALL S

2 X 12W LED Filament Bulbs E27/E26
Dimmable with dimmable bulbs
MADE OF: Opalflex®
WITH: Magnetic System®

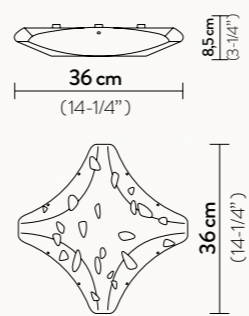

COLOURS:

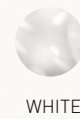

CACTUS PRISMA FLOOR XL

2 X 12W LED Filament Bulbs E27/E26
MADE OF: Lentiflex®
WITH: Stainless Steel base - Dimmer

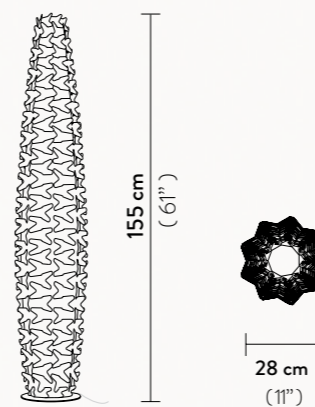

COLOURS:

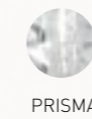

CACTUS FLOOR XXL

2 X 12W LED Filament Bulbs E27/E26
MADE OF: Opalflex®
WITH: Stainless Steel base

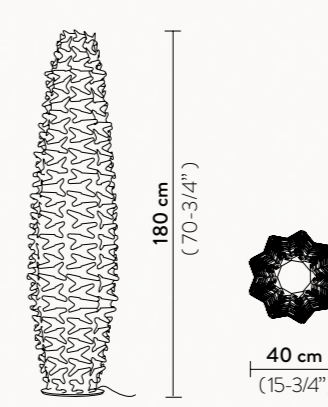

COLOURS:

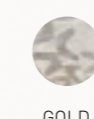

CACTUS FLOOR XL

2 X 12W LED Filament Bulbs E27/E26
MADE OF: Opalflex®
WITH: Stainless Steel base

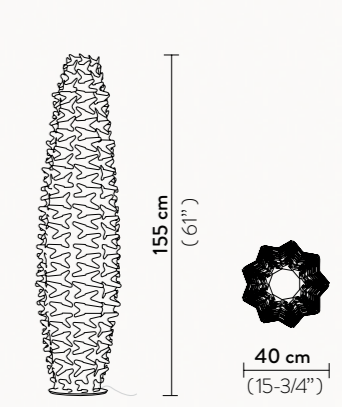

COLOURS:

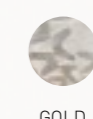

CACTUS TABLE M

1 X 6W LED Filament Bulb E14/E12
 MADE OF: Opalflex®
 WITH: Stainless Steel base



COLOURS:



GOLD

CACTUS TABLE S

1 X 6W LED Filament Bulb E14/E12
 MADE OF: Opalflex®
 WITH: Stainless Steel base

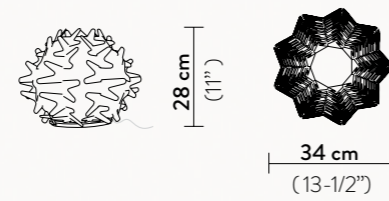

CACTUS PRISMA TABLE XM

1 X 6W LED Filament Bulb E14/E12
 MADE OF: Lentiflex®
 WITH: Stainless Steel base

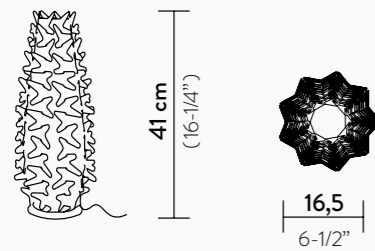

COLOURS:



PRISMA

CACTUS PRISMA TABLE XS

1 X 6W LED Filament Bulb E14/E12
 MADE OF: Lentiflex®
 WITH: Stainless Steel base

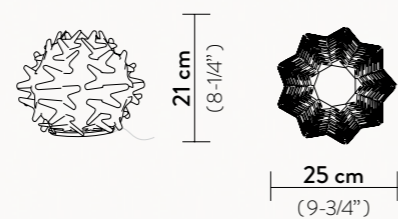

LE GRAND CEREMONY

20 x 8 W - GU10 LED spots
 suggested dim. max Ø5 x h 5 cm (1,96" x h. 1,96")
 + 1 x 15 W - E26/E27 LED spot
 suggested dimension max Ø 6,5 x h 9 cm (2,55" x h. 3,54")
 Dimmable with dimmable bulbs
 MADE OF: Cristalflex® with digital printing
 Structure finishing upon request

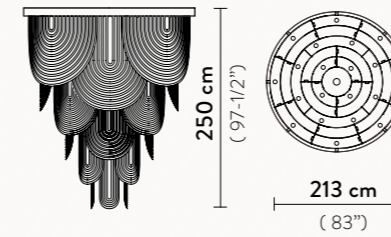

COLOURS:



WHITE

CEREMONY LARGE

4 X 12W LED Filament Bulbs E27/E26
 + 1 X 8W GU10 Spot LED Bulb E27/E26
 Dimmable with dimmable bulbs
 MADE OF: Lentiflex® / Cristalflex® / Opalflex®

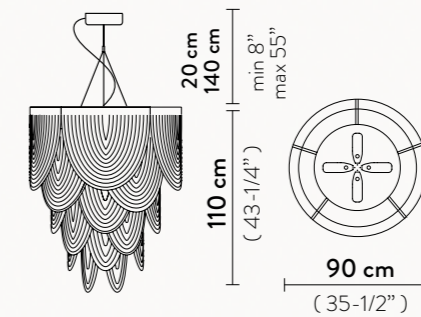

COLOURS:



PRISMA



FUMÉ



WHITE

CEREMONY SMALL

3 X 12W LED Filament Bulbs E27/E26
 + 1 X 8W GU10 Spot LED Bulb E27/E26
 Dimmable with dimmable bulbs
 MADE OF: Lentiflex® / Cristalflex® / Opalflex®

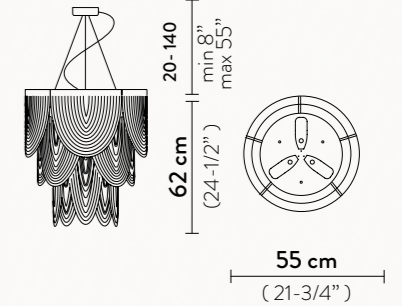

CHANTAL SUSPENSION M

7 X 12W LED Filament Bulbs E27/E26
 Dimmable with dimmable bulbs
 MADE OF: Cristalflex® / Lentiflex®

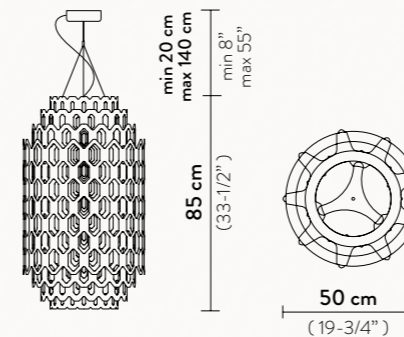

COLOURS:



ORANGE



BLUE



WHITE

CHANTAL SUSPENSION S

4 X 12W LED Filament Bulbs E27/E26
 Dimmable with dimmable bulbs
 MADE OF: Cristalflex® / Lentiflex®
 WITH: Magnetic System®

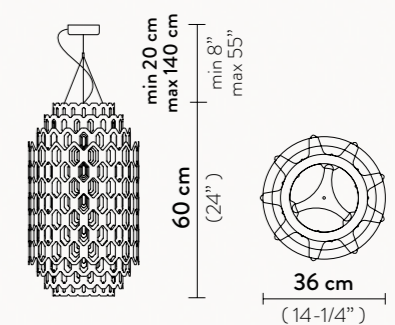

MAGNETIC SYSTEM

CHARLOTTE GLOBE

4 X 12W LED Filament Bulbs E27/E26
Dimmable with dimmable bulbs
MADE OF: Cristalflex® / Lentiflex®
WITH: Magnetic System®

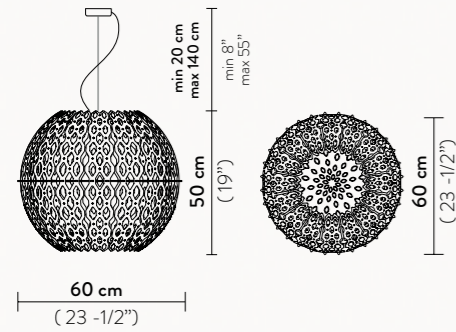

COLOURS:



WHITE



HALF CHARLOTTE SUSPENSION

4 X 12W LED Filament Bulbs E27/E26
Dimmable with dimmable bulbs
MADE OF: Cristalflex® / Lentiflex®

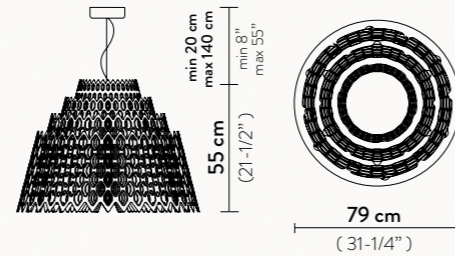

COLOURS:



WHITE

CHARLOTTE WALL LAMP

1 X 12W LED Filament Bulb E27/E26
Dimmable with dimmable bulbs
MADE OF: Cristalflex® / Lentiflex®

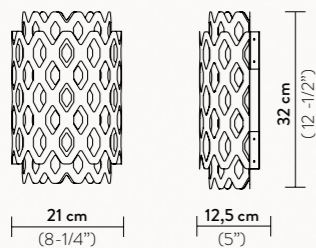

COLOURS:



WHITE

CHARLOTTE FLOOR

2 X 12W - LED Dimmable Bulbs (filament or Spot)
E27/E26
MADE OF: Cristalflex® / Lentiflex®
WITH: Dimmer

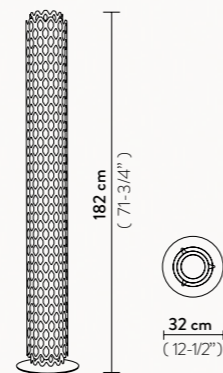

COLOURS:



WHITE

CLIZIA CEILING-WALL L

3 X 12W LED Filament Bulbs E27/E26
Dimmable with dimmable bulbs
MADE OF: Opalflex® / Cristalflex® / Lentiflex®
WITH: Magnetic System®
(Bayonet mount for North America)

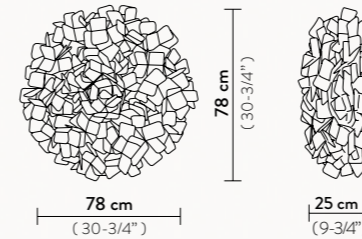

MAMA NON
MAMA - white



MAMA NON
MAMA - black



MAMA NON
MAMA - gold



FUMÉ



WHITE



ORANGE



PURPLE



PIXEL



BLUE
(only M size)

CLIZIA CEILING-WALL M

2 X 12W LED Filament Bulbs E27/E26
Dimmable with dimmable bulbs
MADE OF: Opalflex® / Cristalflex® / Lentiflex®
WITH: Magnetic System®

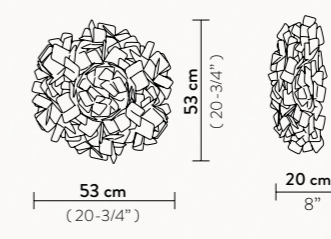

FUMÉ



WHITE



ORANGE



PURPLE



PIXEL



BLUE
(only M size)

CLIZIA CEILING-WALL MINI

2 X 6W LED Filament Bulbs E14/E12
Dimmable with dimmable bulbs
MADE OF: Opalflex® / Cristalflex® / Lentiflex®
WITH: Magnetic System®

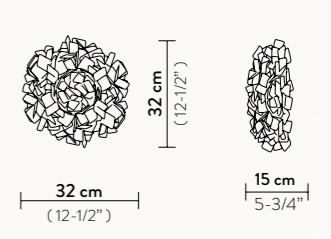

PIXEL



BLUE
(only M size)

CLIZIA SUSPENSION 130

15 X 12W LED Filament Bulbs E27/E26
Dimmable with dimmable bulbs
MADE OF: Polycarbonate
WITH: Magnetic System®

Mama non Mama White, Gold and Clizia Pixel
available with Red wrapped or Transparent cable.

Mama non Mama black available with black wrapped
or transparent cable

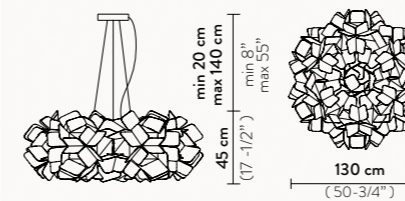

MAMA NON
MAMA - white



MAMA NON
MAMA - black



MAMA NON
MAMA - gold



FUMÉ



WHITE



ORANGE



PURPLE



PIXEL



BLUE
(only M size)

CLIZIA SUSPENSION LARGE

4 X 12W LED Filament Bulbs E27/E26
Dimmable with dimmable bulbs
MADE OF: Opalflex® / Cristalflex® / Lentiflex®
WITH: Magnetic System®

Mama non Mama White, Gold and Clizia Pixel
available with Red wrapped or Transparent cable.

Mama non Mama black available with black wrapped
or transparent cable

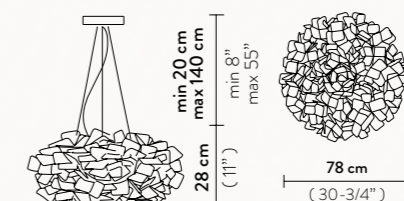

FUMÉ



WHITE



ORANGE



PURPLE



PIXEL



BLUE
(only M size)

CLIZIA SUSPENSION

2 X 12W LED Filament Bulbs E27/E26
Dimmable with dimmable bulbs
MADE OF: Opalflex® / Cristalflex® / Lentiflex®
WITH: Magnetic System®

Mama non Mama White, Gold and Clizia Pixel
available with Red wrapped or Transparent cable.

Mama non Mama black available with black wrapped
or transparent cable

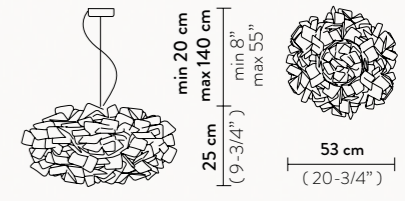

PIXEL



BLUE
(only M size)

CLIZIA APPLIQUE

2 X 6W LED Filament Bulbs E14/E12
Dimmable with dimmable bulbs
MADE OF: Cristalflex®
WITH: Magnetic System®

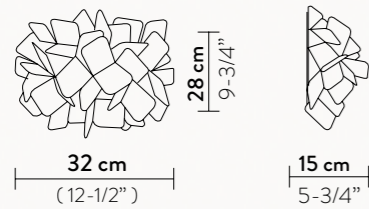

COLOURS:



MAMA NON
MAMA - white



MAMA NON
MAMA - black



MAMA NON
MAMA - gold



MAGNETIC
SYSTEM

CLIZIA BATTERY

LED: 1.3W dimmable- 150 Lumen - 2700 Kelvin
Rechargeable Li-ion Polymer Cell 3.7 Vdc 2500mAh Charge 5 Vdc 1A.
BATTERY DURATION: at max intensity around 6.5 hours duration,
at min intensity around 60 hours duration.
MADE OF: Lentiflex® / Cristalflex®
USB Multicharger station (20 ports) upon request

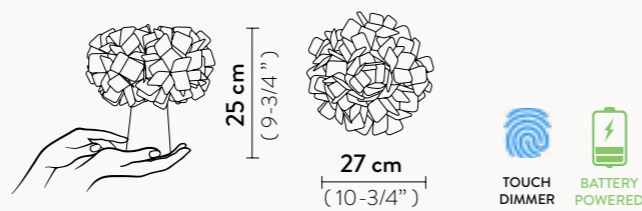

COLOURS:



MAMA NON
MAMA WHITE
(light base)



MAMA NON
MAMA BLACK
(dark base)



FUMÉ
(light base)



MAMA NON
MAMA GOLD
(light base)



MAMA NON
MAMA GOLD
(dark base)

DAFNE CEILING/WALL L

4 X 12W LED Filament Bulbs E27/E26
Dimmable with dimmable bulbs
MADE OF: Opalflex®
WITH: Magnetic System®
(Bayonet mount for North America)

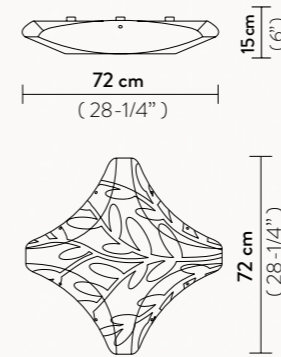

COLOURS:



WHITE



MAGNETIC
SYSTEM

DAFNE CEILING/WALL M

3 X 12W LED Filament Bulbs E27/E26
Dimmable with dimmable bulbs
MADE OF: Opalflex®
WITH: Magnetic System®

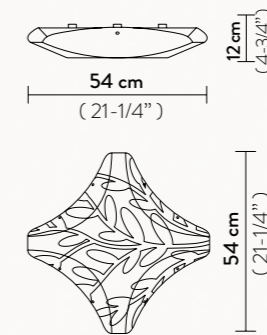

DAFNE CEILING/WALL S

2 X 12W LED Filament Bulbs E27/E26
Dimmable with dimmable bulbs
MADE OF: Opalflex®
WITH: Magnetic System®

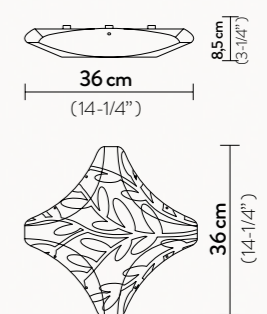

CLIZIA TABLE

1 X 6W LED Filament Bulb E14/E12
MADE OF: Lentiflex® / Cristalflex®
WITH: Magnetic System®

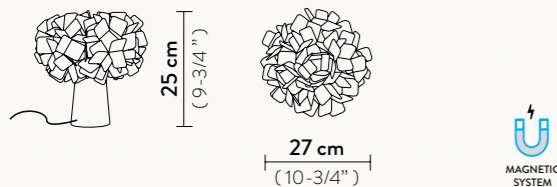

MAMA NON
MAMA GOLD
(light base)



MAMA NON
MAMA GOLD
(black base)



MAMA NON
MAMA BLACK
(dark base)



MAMA NON
MAMA WHITE
(light base)



WHITE (light base)



ORANGE (light base)



PURPLE (purple base)



FUMÉ (light base)



BLACK (dark base)

CORDOBA SUSPENSION

LED: 130W -110-240 Vac /24 Vdc - 15.000 Lumen - 3000 Kelvin
CRI > 90 Dimmable with: PWM / 1-10 or Potentiometer
(110V-220V version)
Additional dimming system Dali, Bluetooth, Casambi, Triac upon request.
MADE OF: Cristalflex®

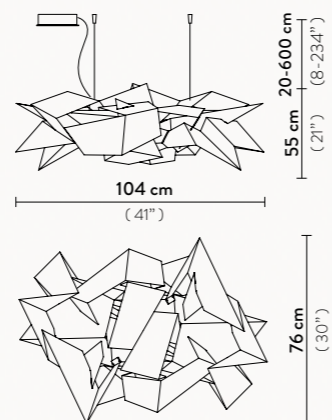

COLOURS:



WHITE

DAFNE FLOOR

3 X 12W LED Filament Bulbs E27/E26
MADE OF: Opalflex®
WITH: Dimmer - Aluminum profiles

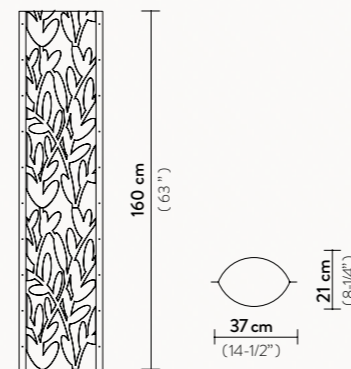

COLOURS:



WHITE

DIAMOND FLOOR L

1 X 12W LED Filament Bulbs E27/E26
MADE OF: Opalflex®
WITH: Aluminium base

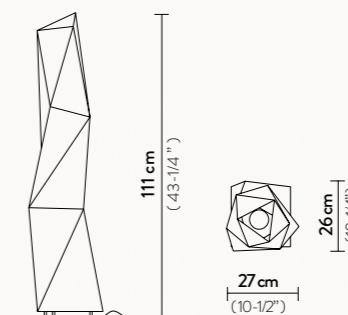

COLOURS:



WHITE

DIAMOND FLOOR M

1 X 12W LED Filament Bulbs E27/E26
MADE OF: Opalflex®
WITH: Aluminium base

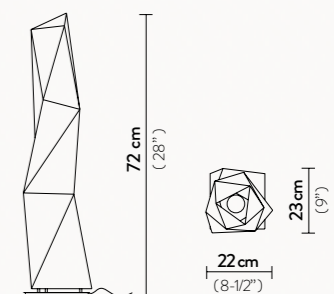

DIAMOND TABLE S

1 X 6W LED Filament Bulb E14/E12
 MADE OF: Opalflex®
 WITH: Aluminium base

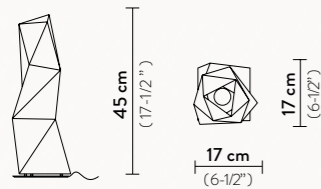

COLOURS:



WHITE

DRUSA SUSPENSION

4 X 12W LED Filament Bulbs E27/E26 - Dimmable with dimmable bulbs
 MADE OF: Lentiflex®
 WITH: Magnetic System®

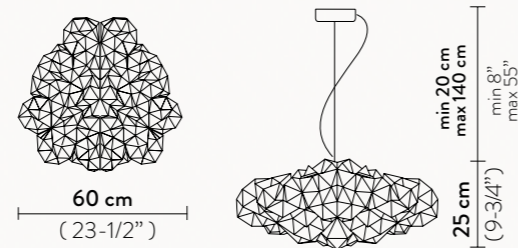

COLOURS:



WHITE



VELVET



ÉTOILE LARGE

LED: 21W - 110-240 Vac /40 Vdc - 2830 Lumen
 2700 Kelvin CRI 90
 220V version dimmable with: PWM / 0-10,
 110V version dimmable with: Triac Trailing Edge
 Additional dimming system Dali, Bluetooth, Casambi, Triac upon request.
 MADE OF: Lentiflex®
 WITH: Patented LED Light Source with Magnetic System®

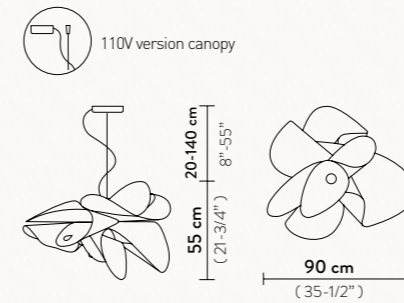

COLOURS:



PRISMA

ÉTOILE

LED: 21W - 110-240 Vac /40 Vdc - 2830 Lumen
 2700 Kelvin CRI 90
 220V version dimmable with: PWM / 0-10,
 110V version dimmable with: Triac Trailing Edge
 Additional dimming system Dali, Bluetooth, Casambi, Triac upon request.
 MADE OF: Lentiflex®
 WITH: Patented LED Light Source with Magnetic System®

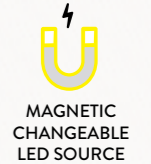
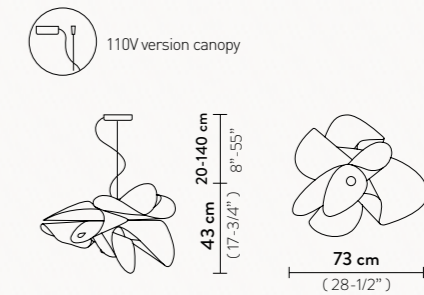

DRUSA CEILING - WALL

4 X 12W LED Filament Bulbs E27/E26
 Dimmable with dimmable bulbs
 MADE OF: Lentiflex®
 WITH: Magnetic System®
 [Bayonet mount for North America]

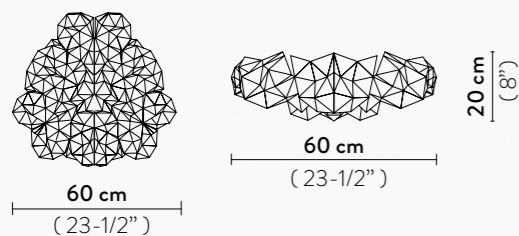

COLOURS:



WHITE



VELVET



ECSTACITY FLOOR

3 X 12W LED Filament Bulbs E27/E26
 MADE OF: Opalflex®
 WITH: Dimmer - Aluminium profiles

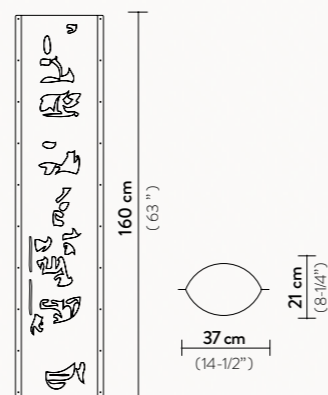

COLOURS:



WHITE

ÉTOILE CEILING / WALL

LED: 15W - 200-240Vac / 40 Vdc - 2150 Lumen
 2700 Kelvin - CRI 90
 Dimmable with Triac Trailing Edge (110V-220V)
 Additional dimming system Dali, Bluetooth, Casambi, PWM 0/10 - 1/10 upon request
 MADE OF: Lentiflex®
 WITH: MagneticSystem®

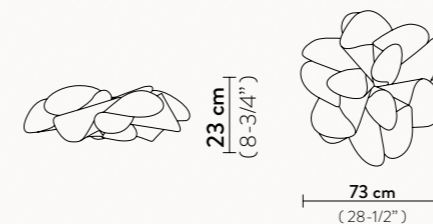

COLOURS:



PRISMA



FABULA SUSPENSION LARGE

5 X 12W LED Filament Bulb E27/E26
 Dimmable with dimmable bulbs
 MADE OF: Lentiflex®
 WITH: Magnetic System®

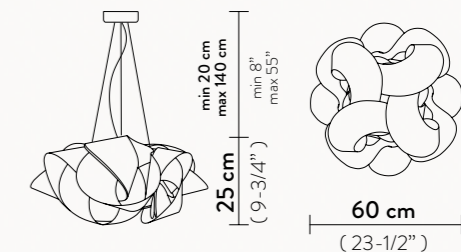

COLOURS:



PRISMA

FABULA SUSPENSION

3 X 12W LED Filament Bulbs E27/E26
Dimmable with dimmable bulbs
MADE OF: Lentiflex®
WITH: Magnetic System®

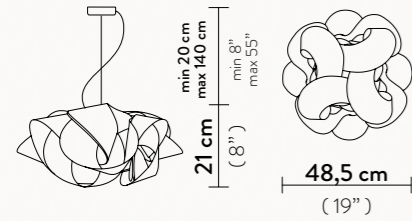

COLOURS:



PRISMA



FABULA CEILING/WALL LARGE

5 X 12W LED Filament Bulbs E27/E26
Dimmable with dimmable bulbs
MADE OF: Lentiflex®
WITH: Magnetic System®

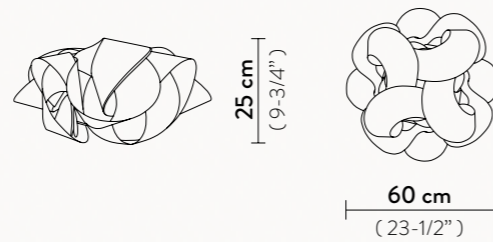

COLOURS:



PRISMA

FIGRELLA SUSPENSION MINI

1 X 12W LED Filament Bulb E27/E26
Dimmable with dimmable bulbs
MADE OF: Opalflex® / Cristalflex® / Goldflex® / Steelflex®
Copperflex®

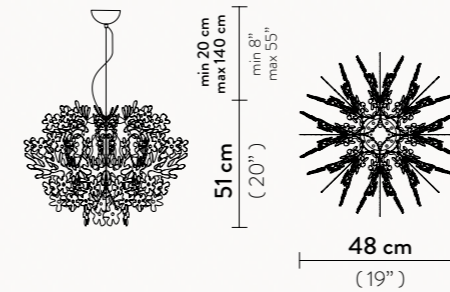

COLOURS:



WHITE



GOLD



SILVER



COPPER

FIGRELLA MINI APPLIQUE

1 X 6W LED Filament Bulb E14/E12
Dimmable with dimmable bulbs
MADE OF: Opalflex® / Cristalflex®
WITH: Stainless Steel Support

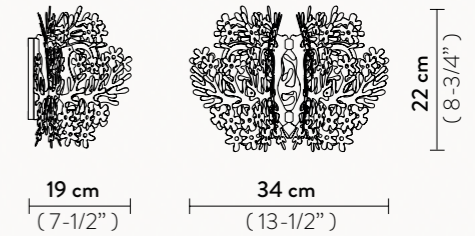

COLOURS:



WHITE

FABULA CEILING/WALL

3 X 12W LED Filament Bulb E27/E26
Dimmable with dimmable bulbs
MADE OF: Lentiflex®
WITH: Magnetic System®

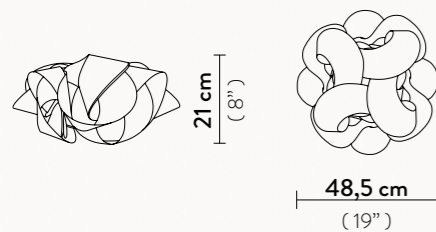

COLOURS:



PRISMA



FIGRELLA SUSPENSION

1 X 12W LED Filament Bulb E27/E26
Dimmable with dimmable bulbs
MADE OF: Opalflex® / Cristalflex®

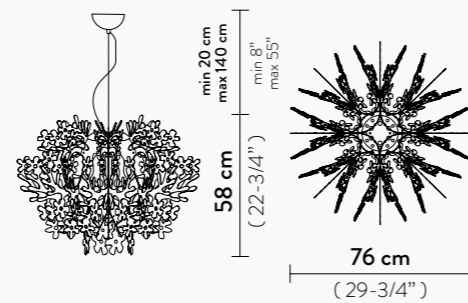

COLOURS:



WHITE

FIGRELLINA TABLE

1 X 6W LED Filament Bulb E14/E12
MADE OF: Opalflex® / Cristalflex®
Goldflex® / Steelflex® / Copperflex®
WITH: Base matching colour

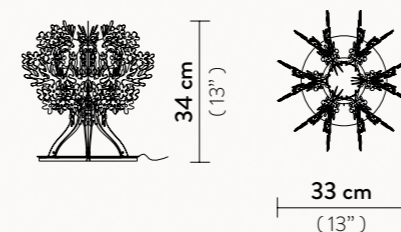

COLOURS:



WHITE



GOLD



SILVER



COPPER

FLORA FLOOR

3 X 12W LED Filament Bulbs E27/E26
MADE OF: Lentiflex® - Methacrylate
Goldflex® / Steelflex® / Copperflex® Pewterflex®
WITH: Magnetic System®
Hand finished Sphere - Dimmer

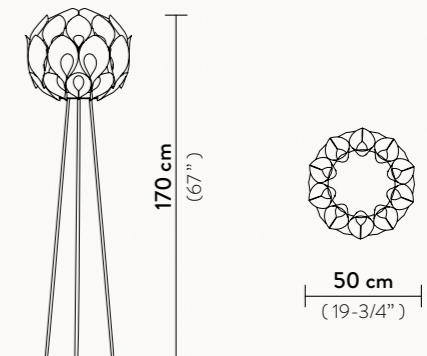

COLOURS:



WHITE



GOLD



SILVER



COPPER



PEWTER



FLORA SUSPENSION M

3 X 12W LED Filament Bulbs E27/E26
Dimmable with dimmable bulbs
MADE OF: Lentiflex® - Methacrylate / Goldflex®
Steelflex®/ Copperflex® / Pewterflex®
WITH: Magnetic System®
Hand - finished Sphere

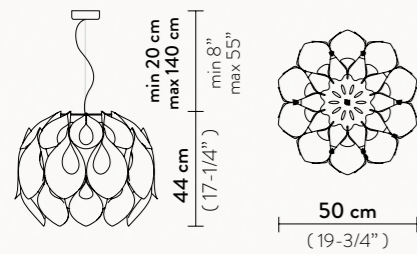

COLOURS:

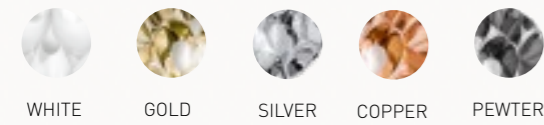

FLORA SUSPENSION S

1 X 12W LED Filament Bulbs E27/E26
Dimmable with dimmable bulbs
MADE OF: Lentiflex® - Methacrylate / Goldflex® / Steelflex®
Copperflex® / Pewterflex®
WITH: Magnetic System®
Hand - finished Sphere

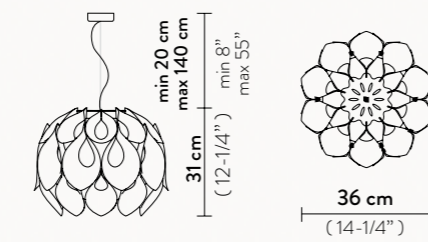

GEMMY SUSPENSION

1 X 12W LED Filament Bulb E27/E26 Dimmable with dimmable bulbs - MADE OF: Opalflex® or Lentiflex®

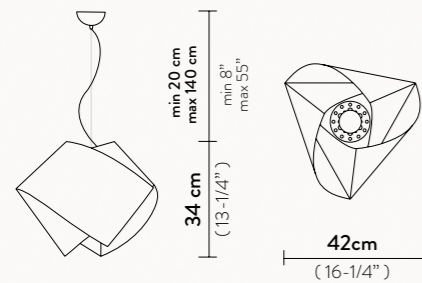

GEMMY TABLE

1 X 6W LED Filament Bulb E14/E12
MADE OF: Opalflex® or Lentiflex®

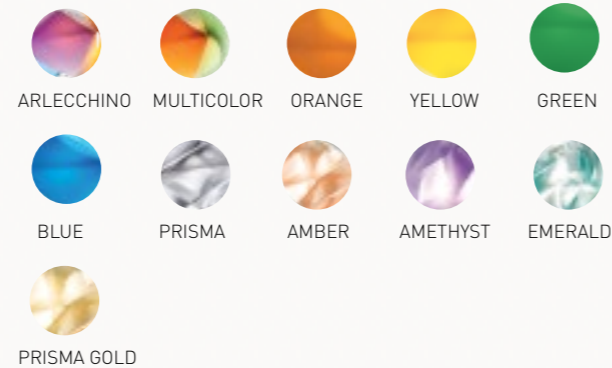
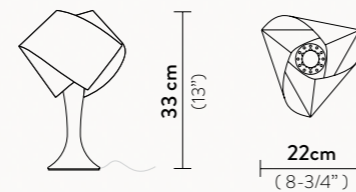

GINETTA SUSPENSION

1 X 12W LED Filament Bulb E27/E26
Dimmable with dimmable bulbs
MADE OF: Opalflex® / Cristalflex® / Steelflex® / Lentiflex®
WITH: Iridescent bulb screen and
Magnetic System® (Prisma version)

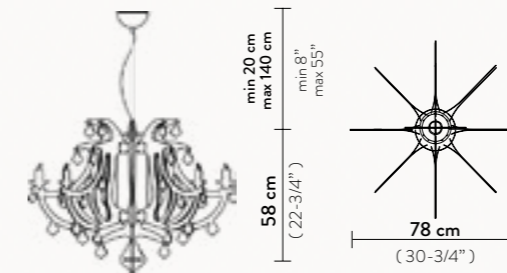

COLOURS:

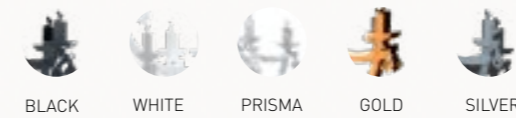

GOCCIA SUSPENSION

1 X 12W LED Filament Bulb E27/E26
Dimmable with dimmable bulbs
MADE OF: Opalflex® / Lentiflex®

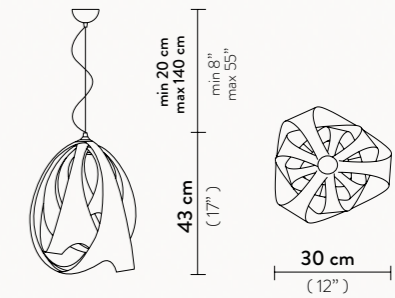

COLOURS:

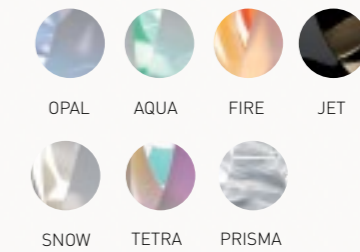

HANAMI SUSPENSION L

10 X 5W LED Dimmable Bulbs G9
MADE OF: Lentiflex® / Polycarbonate
Stainless Steel
WITH: Red wrapped electric wire
and Bulbs included
Available also with transparent cable

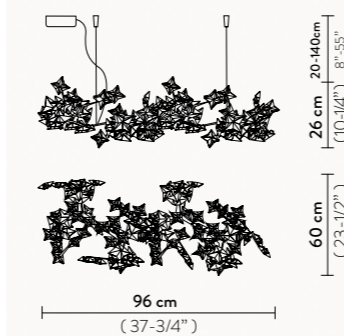

COLOURS:

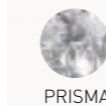

HANAMI SUSPENSION

5 X 5W LED Dimmable Bulbs G9
MADE OF: Lentiflex® / Polycarbonate
Stainless Steel
WITH: Red wrapped electric wire
and Bulbs included
Available also with transparent cable

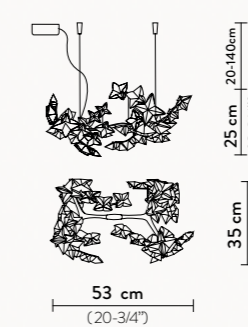

HANAMI CEILING/WALL

7 X 5W LED Dimmable Bulbs G9
MADE OF: Lentiflex® / Polycarbonate and
Stainless Steel
WITH: Bulbs included

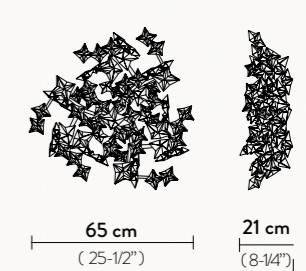

COLOURS:

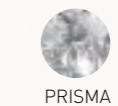

HUGO ARCHITECTURAL SYSTEM

COMPONENTS:

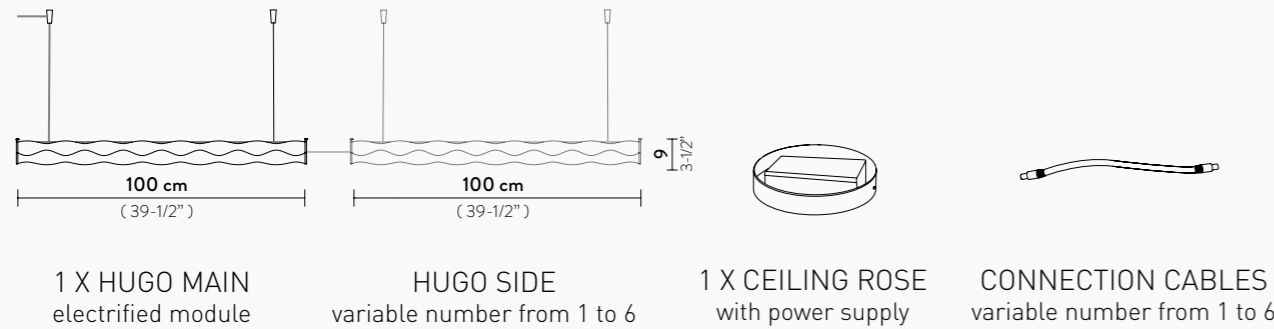

ARCHITECTURAL SYSTEM 2

40W-100~240V/24Vdc - 7000 Lumen
3000 Kelvin (4000 upon request)
Dimmable with: PWM, 0-10 (110V-220V)
Additional dimming system Dali, Bluetooth, Casambi, Triac upon request

ARCHITECTURAL SYSTEM 5

100W-100~240V/24Vdc-17.500 Lumen
3000 Kelvin (4000 upon request)
Dimmable with: PWM, 0-10 or Potentiometer (110V-220V)
Additional dimming system Dali, Bluetooth, Casambi, Triac upon request

ARCHITECTURAL SYSTEM 3

60W-100~240V / 24Vdc - 10.500 Lumen
3000 Kelvin (4000 upon request)
Dimmable with: PWM, 0-10 or Potentiometer (110V-220V)
Additional dimming system Dali, Bluetooth, Casambi, Triac upon request

ARCHITECTURAL SYSTEM 6

120W-100~240V/24Vdc - 21.000 Lumen
3000 Kelvin (4000 upon request)
Dimmable with: PWM, 1-10 or Potentiometer (110V-220V)
Additional dimming system Dali, Bluetooth, Casambi, Triac upon request

ARCHITECTURAL SYSTEM 4

80W-100~240V/24Vdc-14.000 Lumen
3000 Kelvin (4000 upon request)
Dimmable with: PWM, 0-10 or Potentiometer (110V-220V)
Additional dimming system Dali, Bluetooth, Casambi, Triac upon request

ARCHITECTURAL SYSTEM 7

140W-100~240V/24Vdc-24.500 Lumen
3000 Kelvin (4000 upon request)
Dimmable with: PWM, 1-10 or Potentiometer (110V-220V)
Additional dimming system Dali, Bluetooth, Casambi, Triac upon request

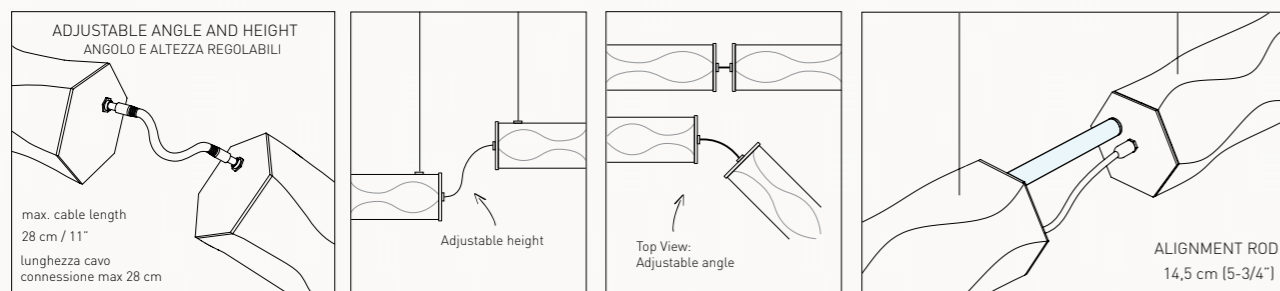

Transparent magnetic alignment rod to perfectly align modules are available upon request

Disponibile su richiesta una barretta trasparente con estremità magnetiche per tenere i moduli perfettamente allineati.

COLOURS:



PRISMA WHITE

HUGO SUSPENSION

LED: 25W - 100 ~ 240 Vac /24 Vdc - 3.500 Lumen
3000 Kelvin (4000 upon request) - CRI >90
Dimmable with: PWM / 0-10 (110V-220V)

Additional dimming system Dali, Bluetooth, Casambi, Triac upon request

MADE OF: Lentiflex®

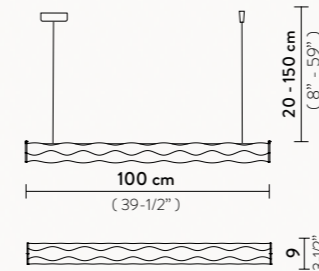

COLOURS:

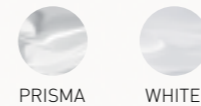

PRISMA WHITE

HUGO FLOOR

LED: 40W -100~240Vac/24Vdc - 7.000 lumen
3000 Kelvin - Dimmable
MADE OF: Lentiflex® - Stainless steel
With: Integrated Dimmer

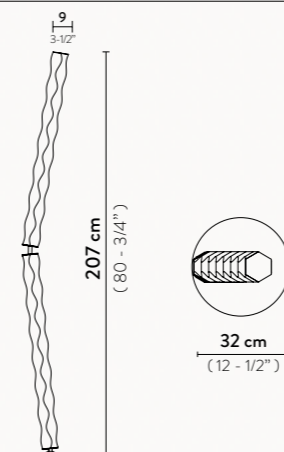

COLOURS:



PRISMA



HUGO VERTICAL

LED: 25W - 100 ~ 240 Vac /24 Vdc - 3.500 Lumen
3000 Kelvin (4000 upon request) - CRI >90
Dimmable with: PWM / 0-10 (110V-220V)

Additional dimming system Dali, Bluetooth, Casambi, Triac upon request

MADE OF: Lentiflex®

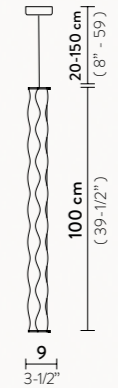

COLOURS:

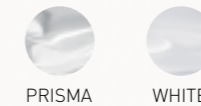

PRISMA WHITE

IDEA TABLE LAMP

1 X 5W G9 LED - 500 Lumen
MADE OF: Technopolymer / Brushed Brass
WITH: Bulb included

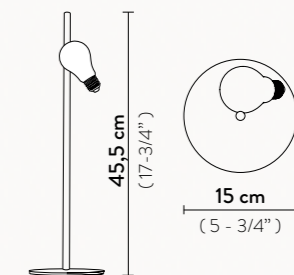
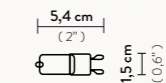

COLOURS:



BRASS

IDEA APPLIQUE

1 X 5W G9 LED Dimmable bulb - 500 Lumen
 MADE OF: Technopolymer / Stainless Steel
 or White coated Steel
 WITH: Bulb included

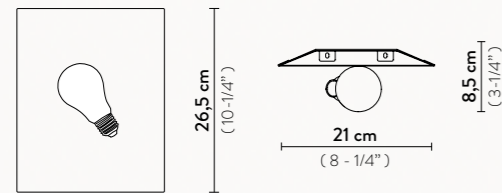
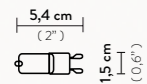

COLOURS:



IDEA RECESSED WALL LAMP

1 X 5W G9 LED Dimmable bulb - 500 Lumen
 MADE OF: Technopolymer /Plaster
 WITH: Bulb included

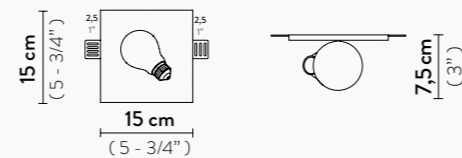
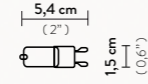

KALATOS CEILING/WALL

4 X 12W LED Filament Bulbs E27/E26
 Dimmable with dimmable bulbs
 MADE OF: Lentiflex® / Polycarbonate
 or Metallized Polycarbonate

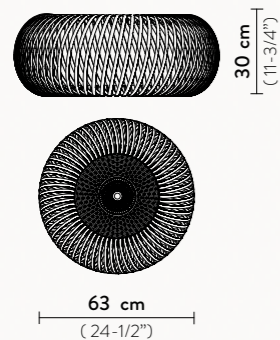

COLOURS:

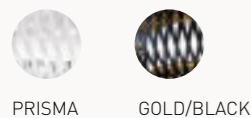

KALATOS SUSPENSION

4 X 12W LED Filament Bulbs E27/E26
 Dimmable with dimmable bulbs
 MADE OF: Lentiflex® / Polycarbonate
 or Metallized Polycarbonate

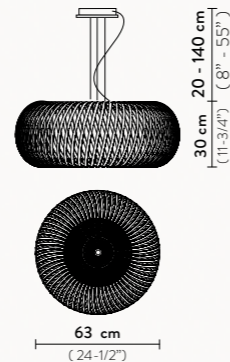

COLOURS:

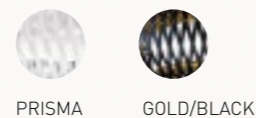

LA BELLE ÉTOILE LARGE

LED: 21W - 110-240 Vac /40 Vdc - 2830 Lumen - 2700 Kelvin CRI 90
 220V version dimmable with: PWM / 0-10, 110V version dimmable with: Triac Trail. Edge
 Additional dimming system Dali, Bluetooth, Casambi, Triac upon request.
 MADE OF: Cristalflex®
 WITH: Patented LED Light Source with Magnetic System®

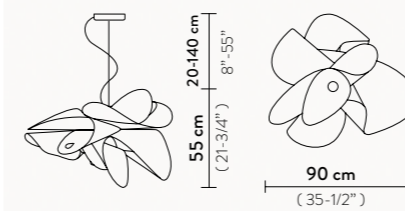
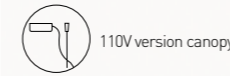

COLOURS:

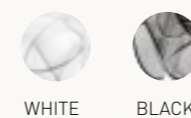

LA BELLE ÉTOILE

LED: 21W - 110-240 Vac /40 Vdc - 2830 Lumen - 2700 Kelvin CRI 90
 220V version dimmable with: PWM / 0-10, 110V version dimmable with: Triac Trail. Edge
 Additional dimming system Dali, Bluetooth, Casambi, Triac upon request.
 MADE OF: Cristalflex®
 WITH: Patented LED Light Source with Magnetic System®

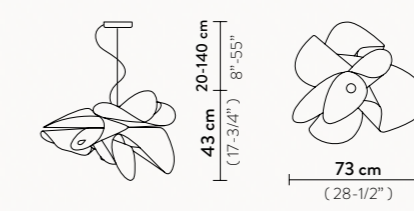

LA BELLE ÉTOILE CEILING / WALL

LED: 15W -200-240Vac / 40 Vdc
 2150 Lumen - 2700 Kelvin - CRI 90
 Dimmable with Triac Trailing Edge (220V-110V)
 Additional dimming system Dali, Bluetooth, Casambi, PWM 010 - 1/10 upon request
 MADE OF: Cristalflex®
 WITH: Magnetic System®



COLOURS:

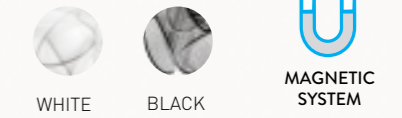

LA LOLLO XL

LED: 130W - 110-240Vac/ 24Vdc
 15.000 Lumen - 2700 Kelvin - CRI >90
 220V version dimmable with: PWM / 0-10 or Potentiometer
 110V version dimmable with: Triac
 Additional dimming system Dali, Bluetooth, Casambi, Triac upon request

MADE OF: Cristalflex® / Lentiflex® / Opalflex® Brushed Goldflex® or Pewterflex®

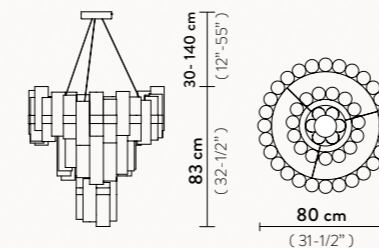

COLOURS:

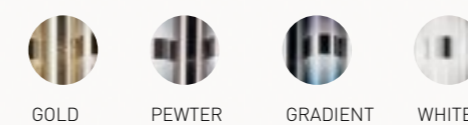

LA LOLLO L

LED: 80W - 110-240Vac/ 24Vdc
 9.000 Lumen - 2700 Kelvin - CRI >90
 220V version dimmable with: PWM / 0-10 or Potentiometer
 110V version dimmable with: Triac
 Additional dimming system Dali, Bluetooth, Casambi, Triac upon request

MADE OF: Cristalflex® / Lentiflex® / Opalflex® Brushed Goldflex® or Pewterflex®

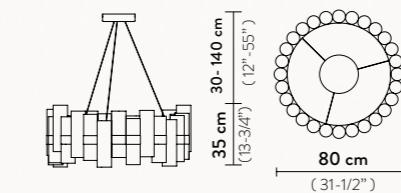

CUSTOMIZABLE:

Product's diameter can be customized for the project
 Technical lighting details will be adapted to the specific project.

LA LOLLO M

LED: 40W - 110-240Vac/ 24Vdc
 4.600 Lumen - 2700 Kelvin - CRI >90
 220V version dimmable with: PWM / 0-10 or Potentiometer
 110V version dimmable with: Triac
 Additional dimming system Dali, Bluetooth, Casambi, Triac upon request

MADE OF: Cristalflex® / Lentiflex® / Opalflex® Brushed Goldflex® or Pewterflex®

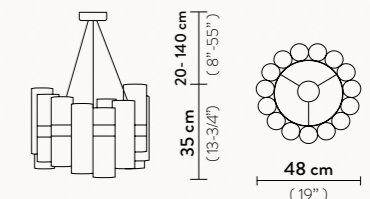

LA LOLLO APPLIQUE

2 X 6W LED Filament Bulbs E14/E12
Dimmable with dimmable bulbs

MADE OF: Cristalflex® / Lentiflex®
Opalflex® Brushed Goldflex® or
Pewterflex®

WITH: Stainless Steel Support

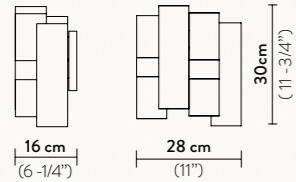

COLOURS:

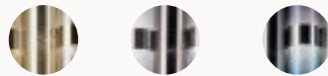

GOLD PEWTER GRADIENT



WHITE

LA LOLLO LINEAR 140

LED: 110W - 110~240Vac /24Vdc
12.420 Lumen - 2700 Kelvin - CRI > 90
Dimmable with: PWM, 0-10 or Potentiometer
110V version dimmable with: Triac
Additional dimming system Dali, Bluetooth,
Casambi, Triac upon request

MADE OF: Cristalflex® / Lentiflex® /
Opalflex® Brushed Goldflex® or Pewterflex®

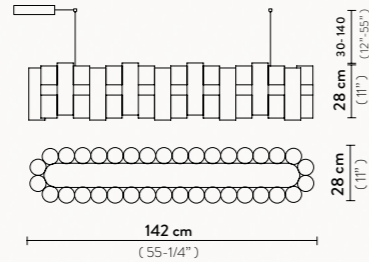

COLOURS:



GOLD PEWTER GRADIENT WHITE

LA LOLLO LINEAR 100

LED: 70W - 110~240Vac /24Vdc
7.820 Lumen - 2700 Kelvin - CRI > 90
Dimmable with: PWM, 0-10 or Potentiometer
110V version dimmable with: Triac
Additional dimming system Dali, Bluetooth,
Casambi, Triac upon request

MADE OF: Cristalflex® / Lentiflex® /
Opalflex® Brushed Goldflex® or Pewterflex®

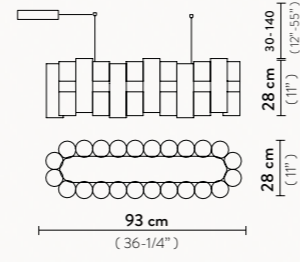

CUSTOMIZABLE:

Product can be customized for the
project, Technical lighting details will
be adapted to the specific project.

LA TRAVIATA 220

13 individually dimmable RGB + 1 White LED Main Light
MAIN LED: 86.4W - 100-240V
7500 Lumen - 3000 Kelvin
WITH: Casambi, DMX Control

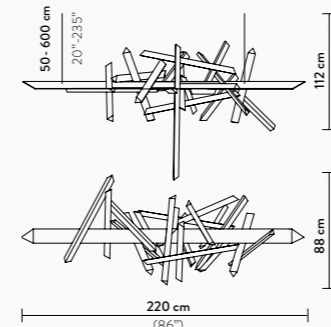

COLOURS:



PRISMA + RGB LIGHTS

LA TRAVIATA 180

9 individually dimmable RGB + 1 White LED Main Light
MAIN LED: 70.8W - 100-240V
6150 Lumen - 3000 Kelvin
WITH: Casambi, DMX Control

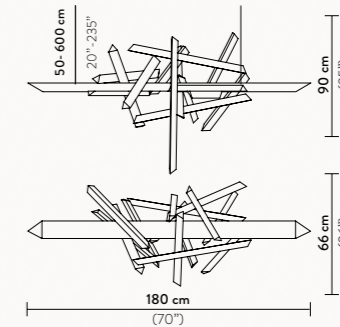

LA LOLLONA 5

LED: 390 W - 100~240Vac/ 24Vdc
44.555 Lumen - 2700 Kelvin - CRI >90
Dimmable with PWM / 0-10 or
Potentiometer (110V-220V)

Additional dimming system Dali, Casambi
upon request

MADE OF: Cristalflex® / Lentiflex® / Opalflex®
Brushed Goldflex® or Pewterflex®

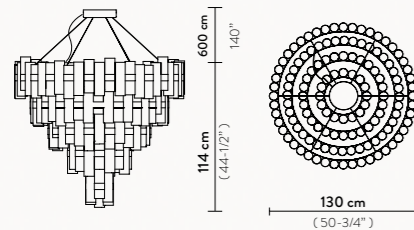

COLOURS:

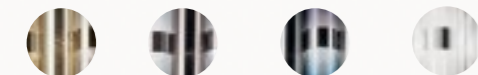

GOLD PEWTER GRADIENT WHITE

LA LOLLONA 4

LED: 242 W - 100~240Vac/ 24Vdc
28.140 Lumen - 2700 Kelvin - CRI >90
Dimmable with PWM / 0-10 or
Potentiometer (110V-220V)

Additional dimming system Dali, Casambi
upon request

MADE OF: Cristalflex® / Lentiflex® / Opalflex®
Brushed Goldflex® or Pewterflex®

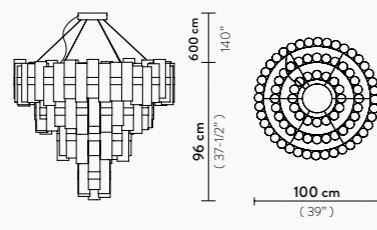

CUSTOMIZABLE:

Product's diameter can be customized
for the project. Technical lighting
details will be adapted to the specific
project.

LA LOLLO FLOOR

3 X 12W LED Dimmable Filament
Bulbs E27/E26

MADE OF: Cristalflex® / Lentiflex® /
Steelflex® or Goldflex®

WITH: Stainless Steel Base - Dimmer

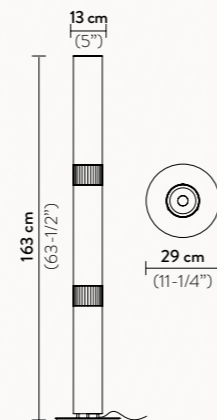

COLOURS:



PRISMA with silver band PRISMA with gold band

LAVIE CEILING-WALL L

3 X 12W LED Filament Bulbs E27/E26
Dimmable with dimmable bulbs
MADE OF: Opalflex® /Lentiflex®
WITH: Magnetic System®
(Bayonet mount for North America)

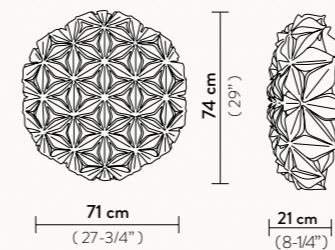

COLOURS:

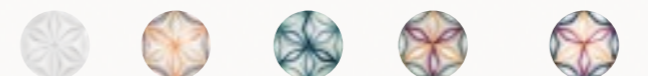

WHITE AMBER BLUE MULTIGREEN (only M version) MULTIBLUE (only M version)

LAVIE CEILING-WALL M

2 X 12W LED Filament Bulbs E27/E26
Dimmable with dimmable bulbs
MADE OF: Opalflex® /Lentiflex®
WITH: Magnetic System®

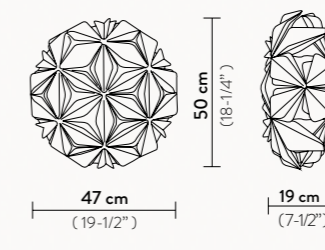

LAVIE CEILING-WALL MINI

2 X 6W LED Filament Bulbs E14/E12
Dimmable with dimmable bulbs
MADE OF: Opalflex® /Lentiflex®
WITH: Magnetic System®

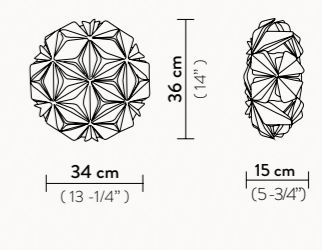

MAGNETIC SYSTEM

LAFLEUR BATTERY

LED: 1.3W dimmable- 150 Lumen - 2700 Kelvin
 Rechargeable Li-ion Polymer Cell 3.7 Vdc 2500mAh
 Charge 5 Vdc 1A.

BATTERY DURATION: at max intensity around 6.5 hours duration, at min intensity around 60 hours duration.

Magnetic Base and Complementary Steel Anchor

MADE OF: Lentiflex® / Copper Wires

USB Multicharger station (20 ports) upon request

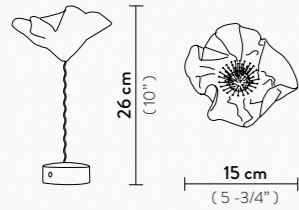

COLOURS:



VELVET
with black base



PRISMA
with white base



LAFLEUR APPLIQUE

1 X 3W G4 LED - 450 Lumen - 2900 / 3000 Kelvin

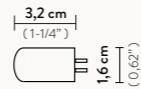

Power Supply 110-220Vac / 12 Vdc - Dimmable with Triac

Additional dimming system Dali, Bluetooth, Casambi, upon request

MADE OF: Lentiflex® / Copper Wires / Painted iron structure

WITH: Bulb included

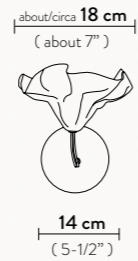

about/circa 16 cm
(about 6 inches)

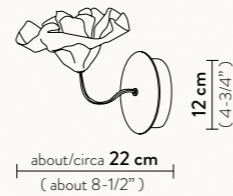

about/circa 22 cm
(about 8-1/2 inches)

Stated dimension may vary by several cm/inches as the blossom-decor is handcrafted.

COLOURS:



VELVET
with black structure



PRISMA
with white structure

LILLIBET

1 X 12W LED Filament Bulb E27/E26

Dimmable with dimmable bulbs

MADE OF: Opalflex® / Cristalflex®

Steelflex® / Goldflex® / Copperflex®

WITH: 56 Schöler® Crystals

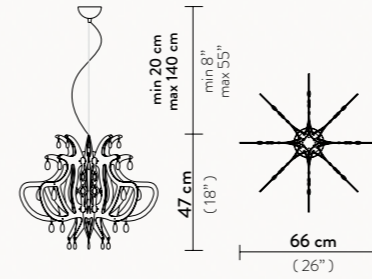

COLOURS:

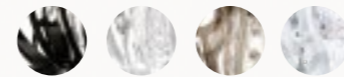

BLACK WHITE FUMÉ TRANSPARENT

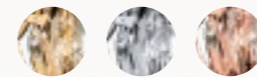

GOLD SILVER COPPER

LILLIBET MINI

1 X 6W LED Filament Bulb E14/E12

Dimmable with dimmable bulbs

MADE OF: Opalflex® / Cristalflex®

WITH: 42 Schöler® Crystals

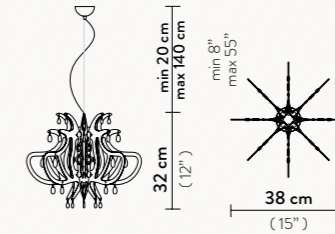

COLOURS:



BLACK WHITE

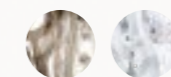

FUMÉ TRANSPARENT

LILLIBET MINI WALL

1 X 6W LED Filament Bulb E14/E12

Dimmable with dimmable bulbs

MADE OF: Opalflex® / Cristalflex®

WITH: 26 Schöler® Crystals

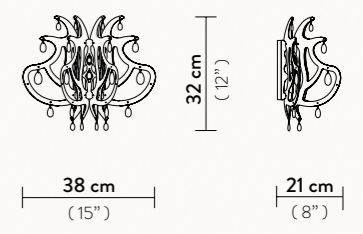

COLOURS:

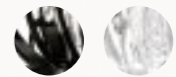

BLACK WHITE

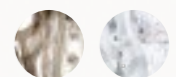

FUMÉ TRANSPARENT

LAS PALMAS FLOOR XL

3 X 12W LED Filament Bulbs E27/E26

MADE OF: Opalflex® / Polycarbonate

WITH: Stainless Steel Base and profiles

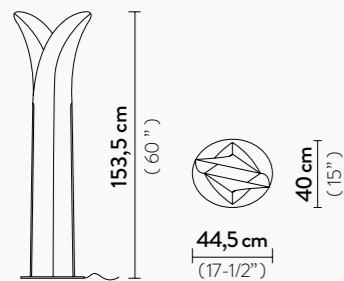

COLOURS:



WHITE

LAS PALMAS FLOOR L

2 X 12W LED Filament Bulbs E27/E26

MADE OF: Opalflex® / Polycarbonate

WITH: Stainless Steel Base and profiles

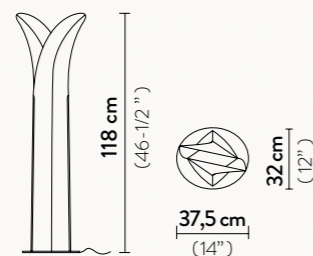

COLOURS:



WHITE

LAS PALMAS TABLE S

1 X 6W LED Filament Bulb E14/E12

MADE OF: Opalflex® / Polycarbonate

WITH: Stainless Steel Base and profiles

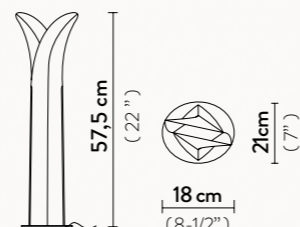

COLOURS:



WHITE

LIZA TABLE

1 X 12W LED Filament Bulb E27/E26

BASE LED: 1 X 2,5W G9 LED

MADE OF: Lentiflex® or Pewterflex®

Polycarbonate and Cristalflex®

WITH: 2 Positions light switch

Courtesy base LED bulb included

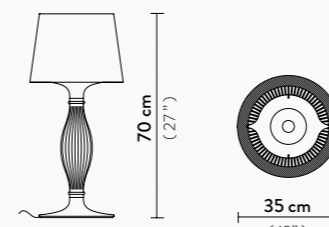

COLOURS:

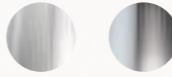

PRISMA PEWTER



2 INDEPENDENT
LIGHT SOURCES

LIZA SUSPENSION

1 X 12W LED Filament Bulb E27/E26

Dimmable with dimmable bulbs

MADE OF: Lentiflex®

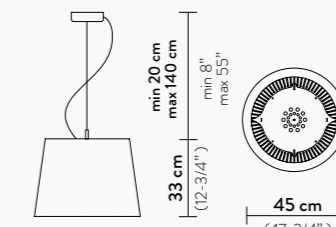

COLOURS:



PRISMA

LUIS SUSPENSION

1 X 12W LED Filament Bulb E27/E26

Dimmable with dimmable bulbs

MADE OF: Lentiflex® / Opalflex®

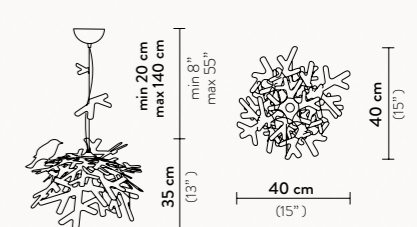

COLOURS:

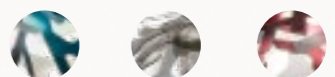

BLUE GOLD PURPLE

MEDUSA SUSPENSION

1 X 12W LED Filament Bulbs E27/E26
Dimmable with dimmable bulbs
MADE OF: Opalflex® / Cristalflex®
Pewterflex®
WITH: 56 Crystals

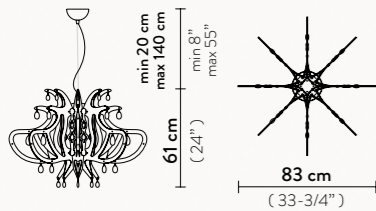

COLOURS:



PRISMA BLUE GEL PEWTER

MEDUSA APPLIQUE

1 X 12W LED Filament Bulb E27/E26
Dimmable with dimmable bulbs
MADE OF: Opalflex® / Cristalflex®
Pewterflex®
WITH: 26 Crystals

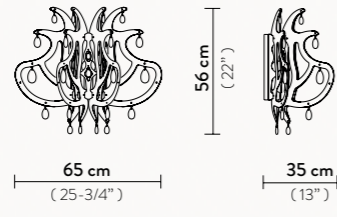

COLOURS:

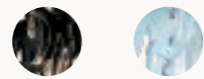

PRISMA BLUE GEL

MIDA APPLIQUE

2 X 6W LED Filament Bulbs E14/E12
Dimmable with dimmable bulbs
MADE OF: Opalflex® / Lentiflex® /
Steelflex® Copperflex® / Brushed
Goldflex®
WITH: Magnetic System®

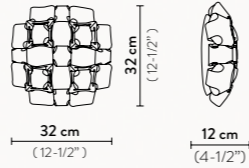

COLOURS:



AMBER WHITE/ PLATINUM ROSE

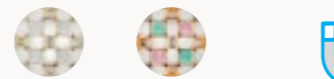

WHITE/ GOLD MULTICOLOR MAGNETIC SYSTEM

MODULA LINEAR FLOOR

LED: 70W - 100-240Vac/24Vdc
7.542 Lumen - 3000 Kelvin
MADE OF: Diffuser in Lentiflex® - Abs structure
WITH: Steel base, Dimmer

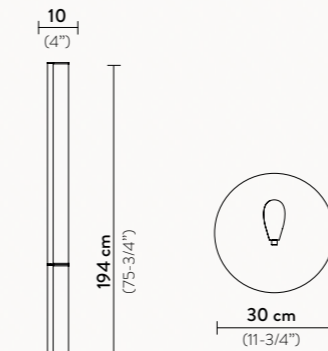

LIGHT GREY CRYSTAL LIGHT GREY PLISSÉ BLACK CRYSTAL BLACK PLISSÉ

MODULA TWISTED FLOOR

LED: 70W - 100-240Vac/24Vdc
7.542 Lumen - 3000 Kelvin
MADE OF: Diffuser in Lentiflex® - Abs structure
WITH: Steel base, Dimmer

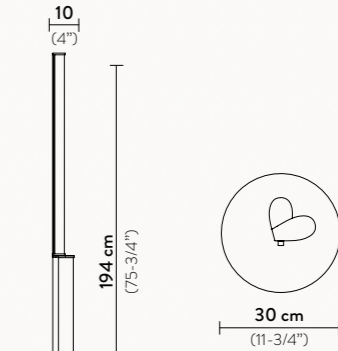

MIDA CEILING-WALL L

4 X 12W LED Filament Bulbs E27/E26
Dimmable with dimmable bulbs
MADE OF: Opalflex® / Lentiflex® /
Steelflex® Copperflex® / Brushed
Goldflex®
WITH: Magnetic System®

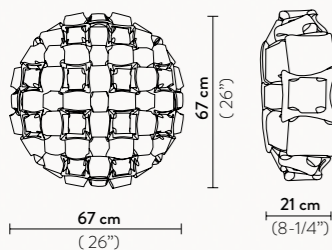

COLOURS:

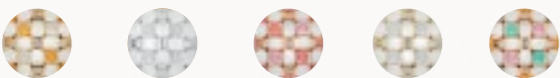

AMBER WHITE/ PLATINUM ROSE WHITE/ GOLD MULTICOLOR



MIDA CEILING-WALL M

3 X 12W LED Filament Bulbs E27/E26
Dimmable with dimmable bulbs
MADE OF: Opalflex® / Lentiflex® /
Steelflex® Copperflex® / Brushed
Goldflex®
WITH: Magnetic System®

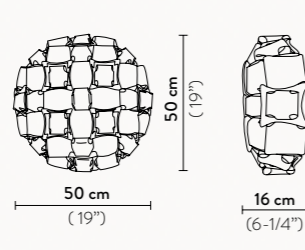

MOON TABLE

1 X 12W LED Filament Bulb E27/E26
MADE OF: Opalflex®
WITH: Aluminium profiles brass finish,
Digital Marble Texture

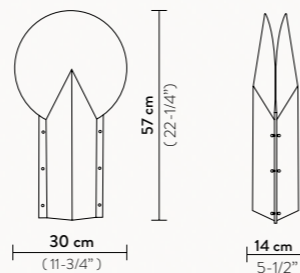

COLOURS:



BLACK WHITE PINK

MODULA SUSPENSION

LED: 35W - 100-240Vac/24Vdc
3.771 Lumen - 3000 Kelvin
Dimmable with: PWM, 0-10 - Additional dimming
system Dali, Bluetooth, Casambi, Triac upon request
MADE OF: Lentiflex® / Abs

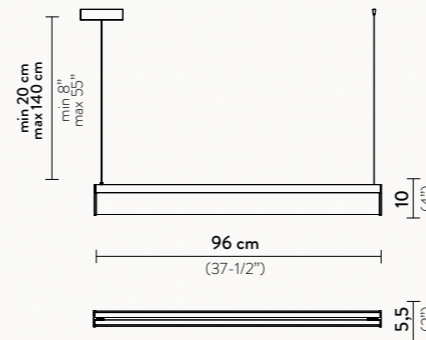

COLOURS:



LIGHT GREY CRYSTAL LIGHT GREY PLISSÉ BLACK CRYSTAL BLACK PLISSÉ

MODULA DOUBLE SUSPENSION

LED: 70W - 100-240Vac/24Vdc
7.542 Lumen - 3000 Kelvin
Dimmable with: PWM, 0-10 - Additional dimming system Dali,
Bluetooth, Casambi, Triac upon request
MADE OF: Lentiflex® / Abs

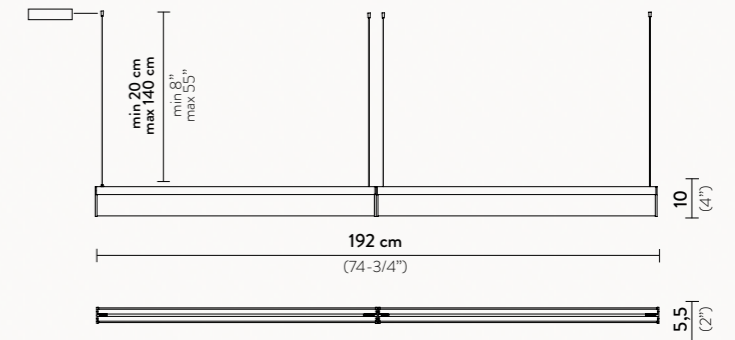

NUVEM MODULAR

2 X 8W LED GU10
 Bidirectional Spot Light
 Dimmable with: dimmable bulbs
 MADE OF: Opalflex® / Lentiflex®

>> Modules of 1 sq. meter can be joined
 in infinite combinations;

>> Moduli da 1 mq
 componibili all'infinito.

>> Available additional modules
 without spotlight

>> Disponibili moduli aggiuntivi senza spotlight

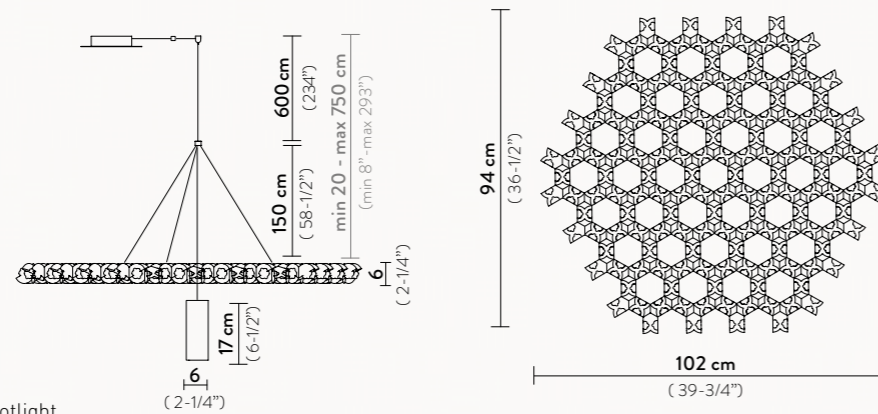

ADDITIONAL SUSPENSION SPOTLIGHT

2 X 8W LED GU10 - Bidirectional Spot Light
 MADE OF: Steel - white RAL 9016 (white version)

Steel - Brushed Brass finish (velvet version)

WHIT: 6 m electric wires
 6 m steel cable

>> GU10 bulbs on request

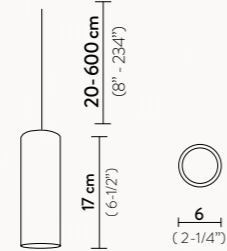

WIRE CEILING ANCHOR INCLUDED



ADDITIONAL CEILING/WALL SPOTLIGHT

LED 10W - 220-240Vac/ 24Vdc

3000 Kelvin- 1550 Lumen - Dimmable

MADE OF: Steel - matte white RAL 9016

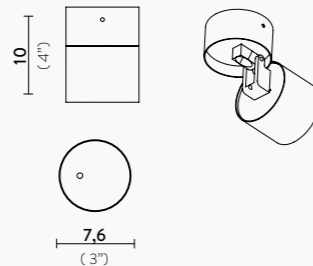

NUVEM CANOPY

Canopy max 6 electric wires

Coppetta con alloggiamento di max 6 cavi

MADE OF: Steel - white RAL 9016

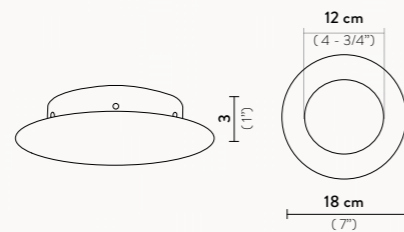

THE CANOPY FITS
 FROM 1 TO 6 MODULES

MODULE COLOUR



WHITE VELVET

BIDIRECTIONAL SUSP. SPOTLIGHT



WHITE - RAL 9016 VELVET - brushed brass finish

CANOPY AND CEILING SPOT AND ANCHOR



WHITE - RAL 9016

ODEON 100 CEILING

12 X 12W LED Filament Bulbs E27/E26

+ 1 X 6,5W Spot LED E27/E26 PAR 38 (Ø12,2 cm x h.13 cm)

Dimmable with dimmable bulbs

MADE OF: Lentiflex® / Goldflex®

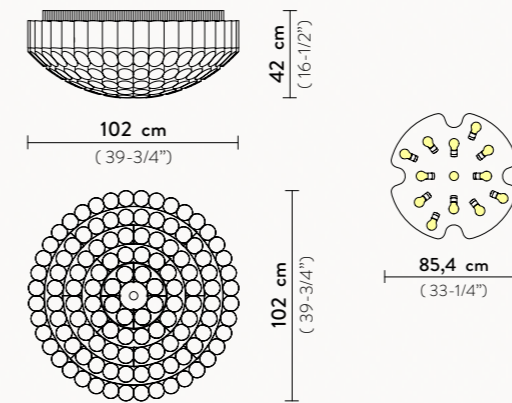

COLOURS:



GOLD

CUSTOMIZABLE:

Product's diameter can be customized for the project, reaching up to 210 cm max (82")
 Technical lighting details will be adapted to the specific project.

ODEON 65 CEILING

6 X 12W LED Filament Bulbs E27/E26

+ 1 X 6,5W Spot LED E27/E26 PAR 38 (Ø12,2 cm x h.13 cm)

Dimmable with dimmable bulbs

MADE OF: Lentiflex® / Goldflex®

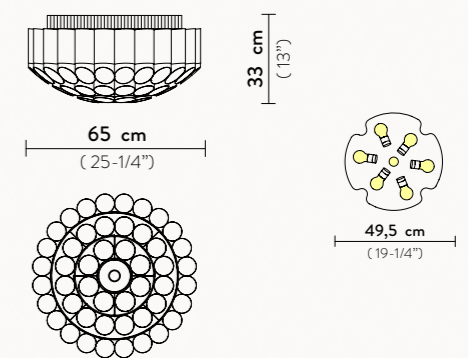

OVERLAY TABLE

Shade LED: 4W - 24Vdc - 500 Lumen - 2700 Kelvin - CRI >90

Base LED: 1,5W - 24Vdc - 90 Lumen - 2700 Kelvin - CRI >90

Made of: Brass, Brushed Copperflex® and Lentiflex®

WITH: LED courtesy light in the base, independent from the principle light source and Montblanc Meisterstück LeGrand writing instrument

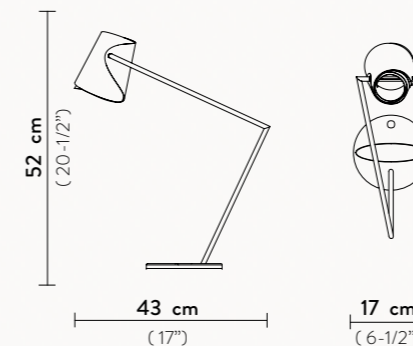

Available with
 Meisterstück LeGrand
 Ballpoint Pen Gold-Coated



COLOURS:



BRASS



2 INDEPENDENT
 LIGHT SOURCES

QUANTICA 120 SUSPENSION

8 X 12W LED Filament Bulb E26/E27

MADE OF: Opalflex®

WITH: cold-coating gold foil

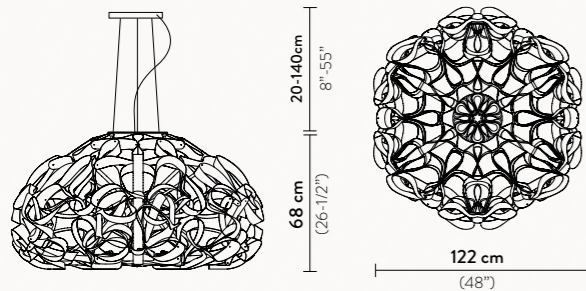

QUANTICA 75 SUSPENSION

4 X 12W LED Filament Bulb E26/E27

MADE OF: Opalflex®

WITH: cold-coating gold foil

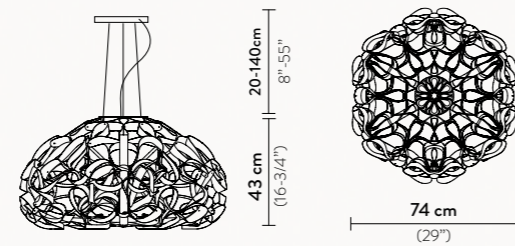

COLOURS:



GOLD

SUPERMORGANA

1 X 5W LED Bulb G9

Dimmable with dimmable bulbs

MADE OF: Metallized Polycarbonate

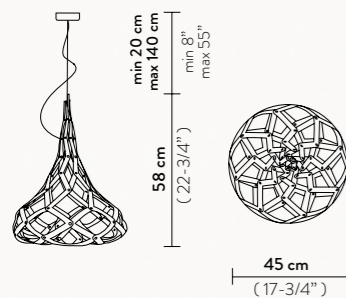

COLOURS:



GOLD/BLACK



MIRROR/BLACK

THE LIGHTNING ARCHIVES FLOOR

3 X 12W LED Filament Dimmable Bulbs E27/E26

MADE OF: Cristalflex® / Opalflex®

WITH: Dimmer - Brass or Coloured finish profiles

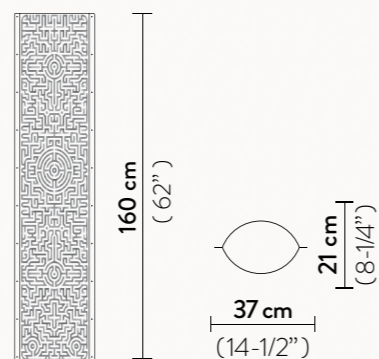

COLOURS:



FAENA



L'AFRIQUE



BANANAS



LABYRINTH



PEACE SKULL



PERISHED



LOVE PEACE JOY

TULIP BATTERY

LED: 1.3W dimmable – 150 Lumen – 2700 Kelvin

Rechargeable Li-ion Polymer Cell 3.7 Vdc 2500mAh Charge 5 Vdc 1A.

BATTERY DURATION: at max intensity around 6 hours duration, at min intensity around 60 h.duration.

MADE OF: Lentiflex® / Cristalflex® / Anodised aluminium

USB Multicharger station (20 ports) upon request

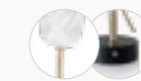
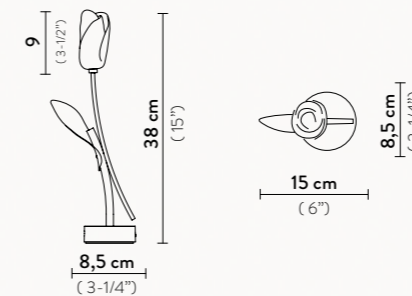

PRISMA
with black base



PRISMA
with white base



TOUCH
DIMMER



BATTERY
POWERED

TULIP 7 ROUND SUSPENSION

LED: 7 x 3.2W LED - 3150 Lumen – 2700 Kelvin

Power Supply: 110 ~220Vac / 24Vdc

Dimmable with: PWM / 0-10

Additional dimming sistem Dali, Bluetooth, Casambi upon request

MADE OF: Lentiflex® / Matte Brushed Brass

WITH: Matte Brushed Brass finish canopy
and copper electric wire

TULIP 14 ROUND SUSPENSION

LED: 14 x 3.2W LED - 6300 Lumen – 2700 Kelvin

Power Supply: 110 ~220Vac / 24Vdc

Dimmable with: PWM / 0-10

Additional dimming sistem Dali, Bluetooth, Casambi upon request

MADE OF: Lentiflex® / Matte Brushed Brass

WITH: Matte Brushed Brass finish canopy
and copper electric wire

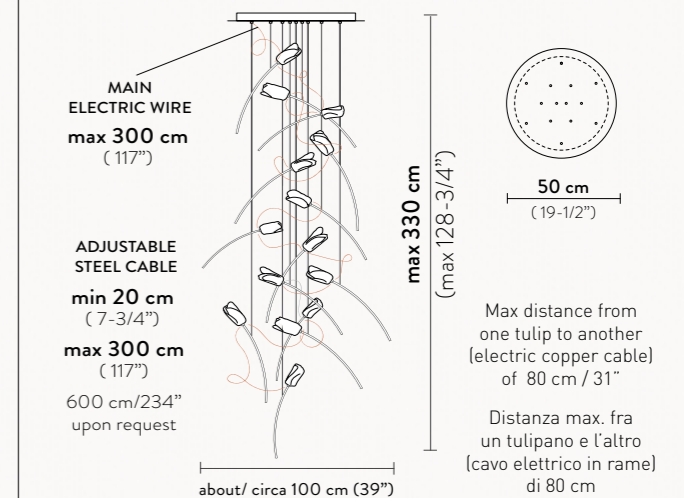
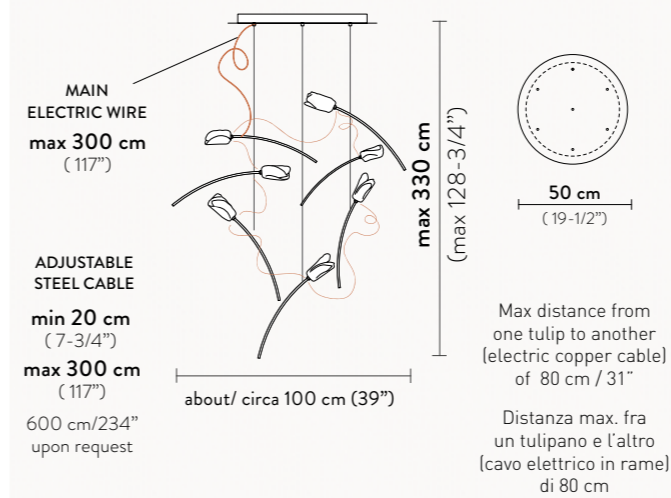

TULIP 7 LINEAR SUSPENSION

LED: 7 x 3.2W LED - 3150 Lumen - 2700 Kelvin
 Power Supply: 110 ~220Vac / 24Vdc
 Dimmable with: PWM / 0-10
 Additional dimming sistem Dali, Bluetooth, Casambi upon request
 MADE OF: Lentiflex® / Matte Brushed Brass
 WITH: Matte Brushed Brass finish canopy and copper electric wire

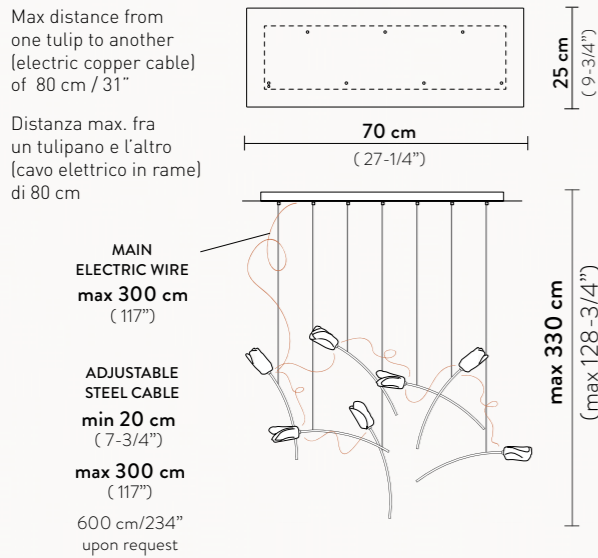

TULIP 14 LINEAR SUSPENSION

LED: 14 x 3.2W LED - 6300 Lumen - 2700 Kelvin
 Power Supply: 110 ~220Vac / 24Vdc
 Dimmable with: PWM / 0-10
 Additional dimming sistem Dali, Bluetooth, Casambi upon request
 MADE OF: Lentiflex® / Matte Brushed Brass
 WITH: Matte Brushed Brass finish canopy and copper electric wire

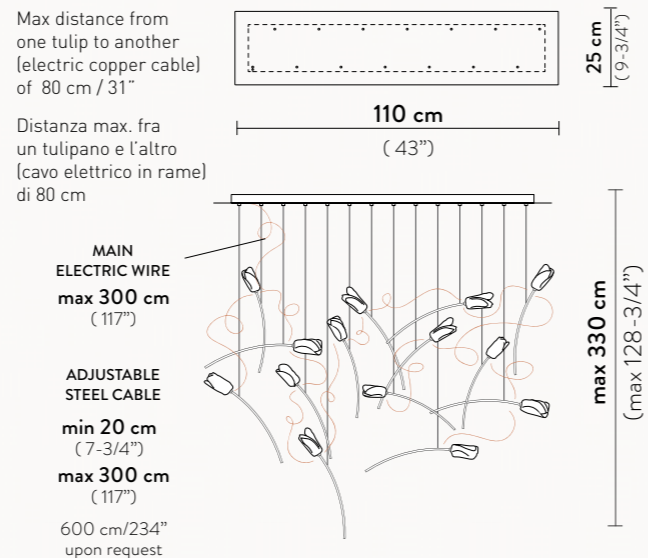

TULIP 14 FREE-STANDING SUSPENSION

LED: 14 x 3.2W LED - 6300 Lumen - 2700 Kelvin
 Power Supply: 110 ~220Vac / 24Vdc
 Dimmable with: PWM / 0-10
 Additional dimming sistem Dali, Bluetooth, Casambi upon request
 MADE OF: Lentiflex® / Matte Brushed Brass
 WITH: Matte Brushed Brass finish canopy and copper electric wire

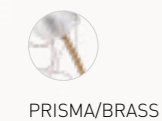
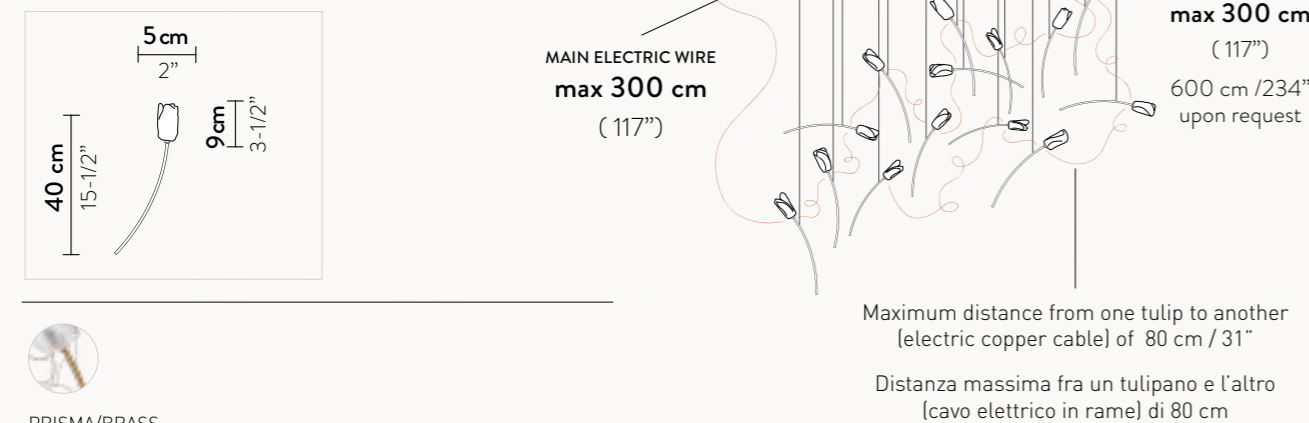

VELI SUSPENSION L

4 X12W LED Filament Bulbs E27/E26
 Dimmable with dimmable bulbs
 MADE OF: Opalflex® / Lentiflex® / Steelflex® Goldflex® / Copperflex®
 WITH: Magnetic System®
 Couture with Red wrapped cable, available also with transparent cable

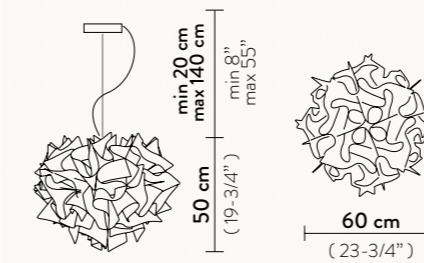

COLOURS:

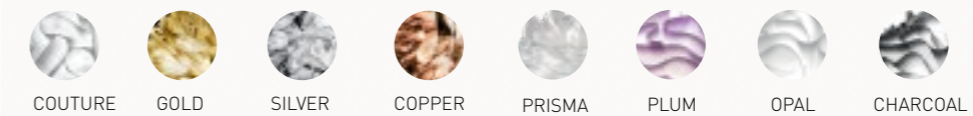

VELI SUSPENSION

2 X12W LED Filament Bulbs E27/E26
 Dimmable with dimmable bulbs
 MADE OF: Opalflex® / Lentiflex® / Steelflex® Goldflex® / Copperflex®
 WITH: Magnetic System®
 Couture with Red wrapped cable, available also with transparent cable

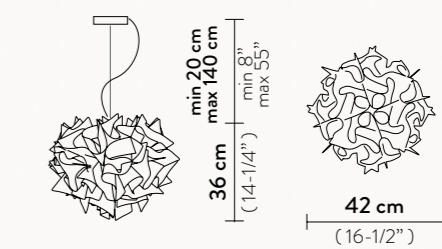

VELI MINI SINGLE

1X 12W LED Filament Bulb E27/E26
 Dimmable with dimmable bulbs
 MADE OF: Opalflex®
 WITH: Magnetic System®
 Red wrapped cable, available also with transparent cable

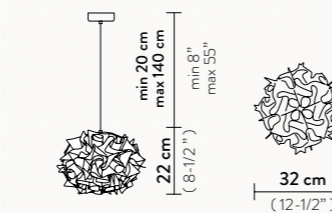

COLOURS:



VELI MINI TRIO

3 X 12W LED Filament Bulbs E27/E26
 Dimmable with dimmable bulbs
 MADE OF: Opalflex®
 WITH: Magnetic System®
 Red wrapped cable, available also with transparent cable

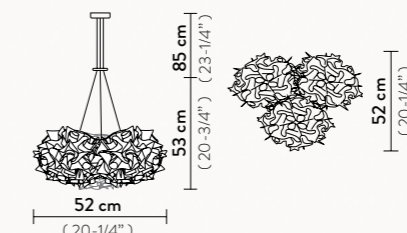

COLOURS:

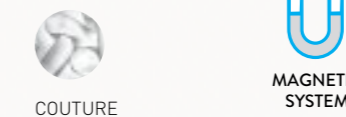

VELI MINI QUARTET

4 X 12W LED Filament Bulbs E27/E26
 Dimmable with dimmable bulbs
 MADE OF: Opalflex®
 WITH: Magnetic System®
 Red wrapped cable, available also with transparent cable

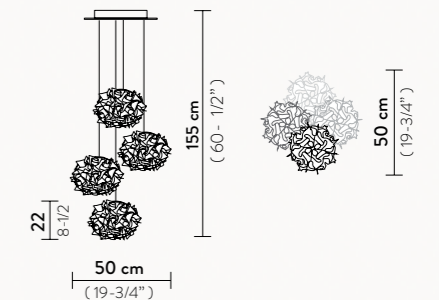

COLOURS:

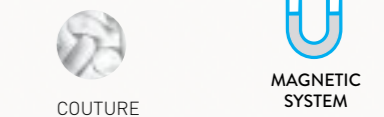

VELI CEILING-WALL L

3 X 12W LED Filament Bulbs E27/E26
Dimmable with dimmable bulbs
MADE OF: Opalflex® / Lentiflex®
Steelflex® / Goldflex® / Copperflex®
WITH: Magnetic System®
(Bayonet mount for North America)

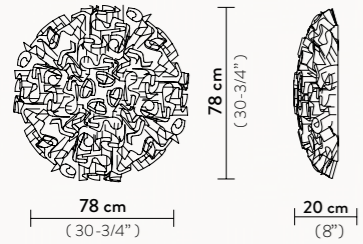

COLOURS:



VELI CEILING-WALL M

2 X 12W LED Filament Bulbs E27/E26
Dimmable with dimmable bulbs
MADE OF: Opalflex® / Lentiflex®
Steelflex® / Goldflex® / Copperflex®
WITH: Magnetic System®

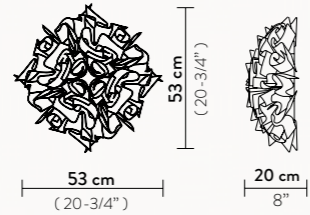

COLOURS:



VELI CEILING-WALL MINI

2 X 6W LED Filament Bulbs E14/E12
Dimmable with dimmable bulbs
MADE OF: Opalflex® / Lentiflex®
Steelflex® / Goldflex® / Copperflex®
WITH: Magnetic System®

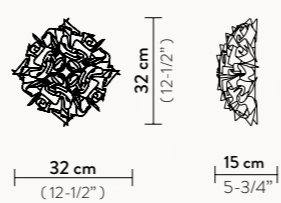

COLOURS:



VELI SUSP FOLIAGE L

4 X 12W LED Filament Bulbs E27/E26
Dimmable with dimmable bulbs
MADE OF: Opalflex®
WITH: Magnetic System®
Couture with Red wrapped cable,
available also with transparent cable

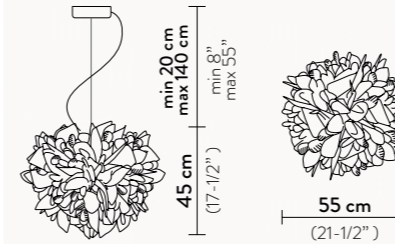

COLOURS:



VELI SUSP FOLIAGE

2 X 12W LED Filament Bulbs E27/E26
Dimmable with dimmable bulbs
MADE OF: Opalflex®
WITH: Magnetic System®
Couture with Red wrapped cable,
available also with transparent cable

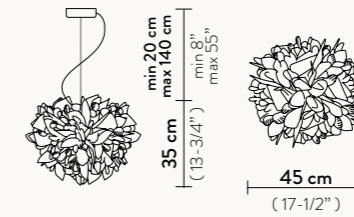

VELI TABLE FOLIAGE

1 X 6W LED Filament Bulb E14/E12
MADE OF: Opalflex® / Metacrylate base
WITH: Magnetic System®

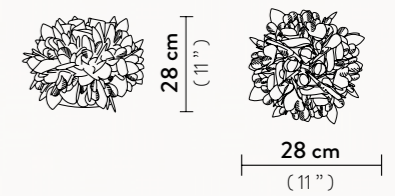

COLOURS:

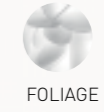

VELI TABLE

1 X 6W LED Filament Bulb E14/E12
MADE OF: Opalflex® / Metacrylate base
WITH: Magnetic System®

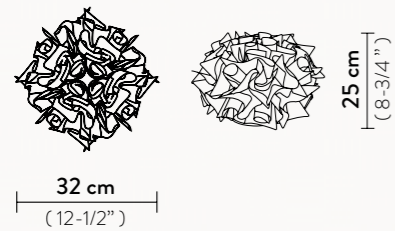

COLOURS:

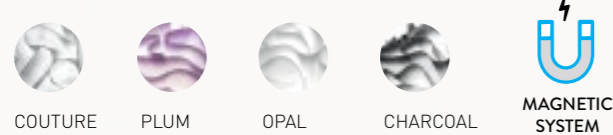

VELI 7

9 X 12W LED Filament Bulb E27/E26
Dimmable with dimmable bulbs
MADE OF: Opalflex®
WITH: Magnetic System®

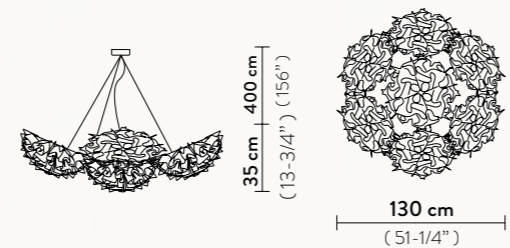

COLOURS:

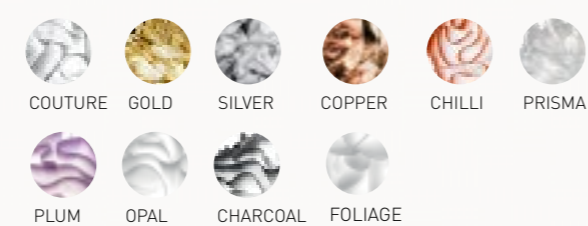

VELI CEILING-WALL FOLIAGE L

3 X 12W LED Filament Bulbs E27/E26
Dimmable with dimmable bulbs
MADE OF: Opalflex®
WITH: Magnetic System®
(Bayonet mount for North America)

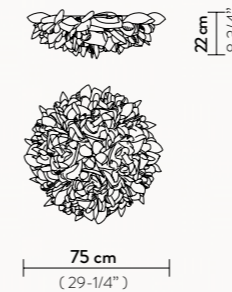

COLOURS:

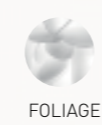

VELI CEILING-WALL FOLIAGE M

2 X 12W LED Filament Bulbs E27/E26
Dimmable with dimmable bulbs
MADE OF: Opalflex®
WITH: Magnetic System®

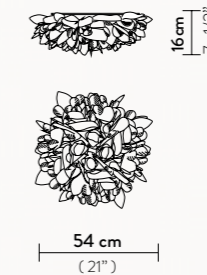

COLOURS:



VELI CEILING-WALL FOLIAGE MINI

2 X 6W LED Filament Bulbs E14/E12
Dimmable with dimmable bulbs
MADE OF: Opalflex®
WITH: Magnetic System®

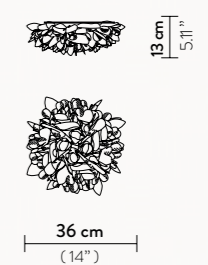

COLOURS:



VENTI CEILING/WALL L

4 X 12W LED Filament Bulbs E27/E26
Dimmable with dimmable bulbs
MADE OF: Opalflex®
WITH: Magnetic System®
[Bayonet mount for North America]

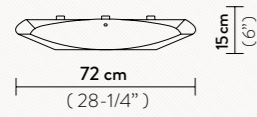

VENTI CEILING/WALL M

3 X 12W LED Filament Bulbs E27/E26
Dimmable with dimmable bulbs
MADE OF: Opalflex®
WITH: Magnetic System®

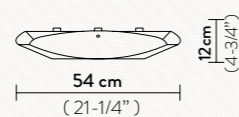

VENTI CEILING/WALL S

2 X 12W LED Filament Bulbs E27/E26
Dimmable with dimmable bulbs
MADE OF: Opalflex®
WITH: Magnetic System®

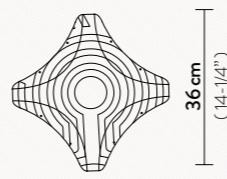
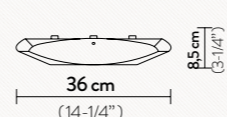

COLOURS:



WHITE



MAGNETIC SYSTEM

VENTI FLOOR

3 X 12W LED Filament Bulbs E27/E26
MADE OF: Opalflex®
WITH: Dimmer - Aluminum profiles

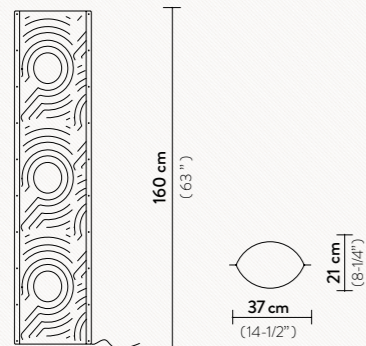

COLOURS:



WHITE

WOODY SUSPENSION

1 X 12W LED Filament Bulb E27/E26
Dimmable with dimmable bulbs
MADE OF: Polycarbonate / Wood

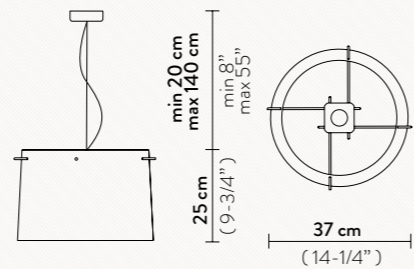

COLOURS:



WHITE



ORANGE



PURPLE



BLUE



SLAMP®

THE LEADING LIGHT

ALL SLAMP PRODUCTS ARE PRODUCED AND ASSEMBLED IN ITALY

WWW.SLAMP.IT

The company in this catalogue suggests the lightbulb wattage for an optimal balance of illumination and aesthetic output per product, as well as bulb size: E27/E26: Ø6 cm (2-1/4") E14/E12: Ø4,5cm (1-1/2"). Higher wattage can be used as long as the bulb is exclusively LED and matches the required size.

Il wattaggio delle lampadine sul seguente catalogo è suggerito dall'azienda per un ottimale balance fra resa luminosa ed estetica del prodotto oltre che alla dimensione del bulbo E27: Ø6 cm - E14: Ø4,5cm. Possono essere utilizzati wattaggi superiori purchè si utilizzino esclusivamente lampadine LED con una dimensione del bulbo adeguata.

Products are patented throughout the world and conform to the leading electrical safety standards. For any further info please ask your Slamp representative.

CE IP 20            CB REPORT AVAILABLE ON REQUEST

 All Slamp lamps are RAEE Standards compliant
Tutte le lampade Slamp sono conformi alla Normativa RAEE

SLAMP S.p.A.
reserves the right to modify products without notice
in the event of commercial conditions rendering this necessary.
Slight differences of colour in some products in this catalogue
are due to the processes involved in printing.

SLAMP S.p.A.
si riserva il diritto di apportare modifiche ai prodotti senza
alcun preavviso, qualora le condizioni commerciali lo rendessero
necessario. Difformità di colore di alcuni prodotti sul presente
catalogo sono dovute a processi di stampa.

SPECIAL THANKS TO



ENTANGLEMENT IS THE PRINCIPLE OF INVOLVEMENT
AND THEN SEPARATION, WHERE PARTICLES INTERACT
FOR A TIME, AND THEN NO LONGER DO SO.

WHEN ONE IS ACTIVATED, THE SECOND,
REGARDLESS OF DISTANCE,
IS INDIVIDUALLY ACTIVATED AS WELL.

WHEN WE SPEND TIME WITH ANOTHER,
OR SELECT AN OBJECT FOR OURSELVES OR OUR SPACE,
WE'VE INNATELY CHOSEN THIS PRINCIPLE THAT OVER TIME,
GREATLY INFLUENCES OUR INDIVIDUAL PATHWAYS.

**THIS IS WHY WE MUST SURROUND
OURSELVES WITH BEAUTY.**

LUCA MAZZA
Slamp Creative Director

HANDMADE IN ITALY
WWW.SLAMP.COM



ENTANGLED LIGHT

SLAMP: