

Novelties 2023

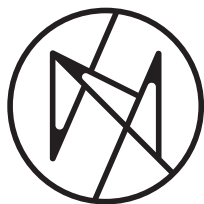

Nowodvorski
LIGHTING



Nowodvorski
LIGHTING

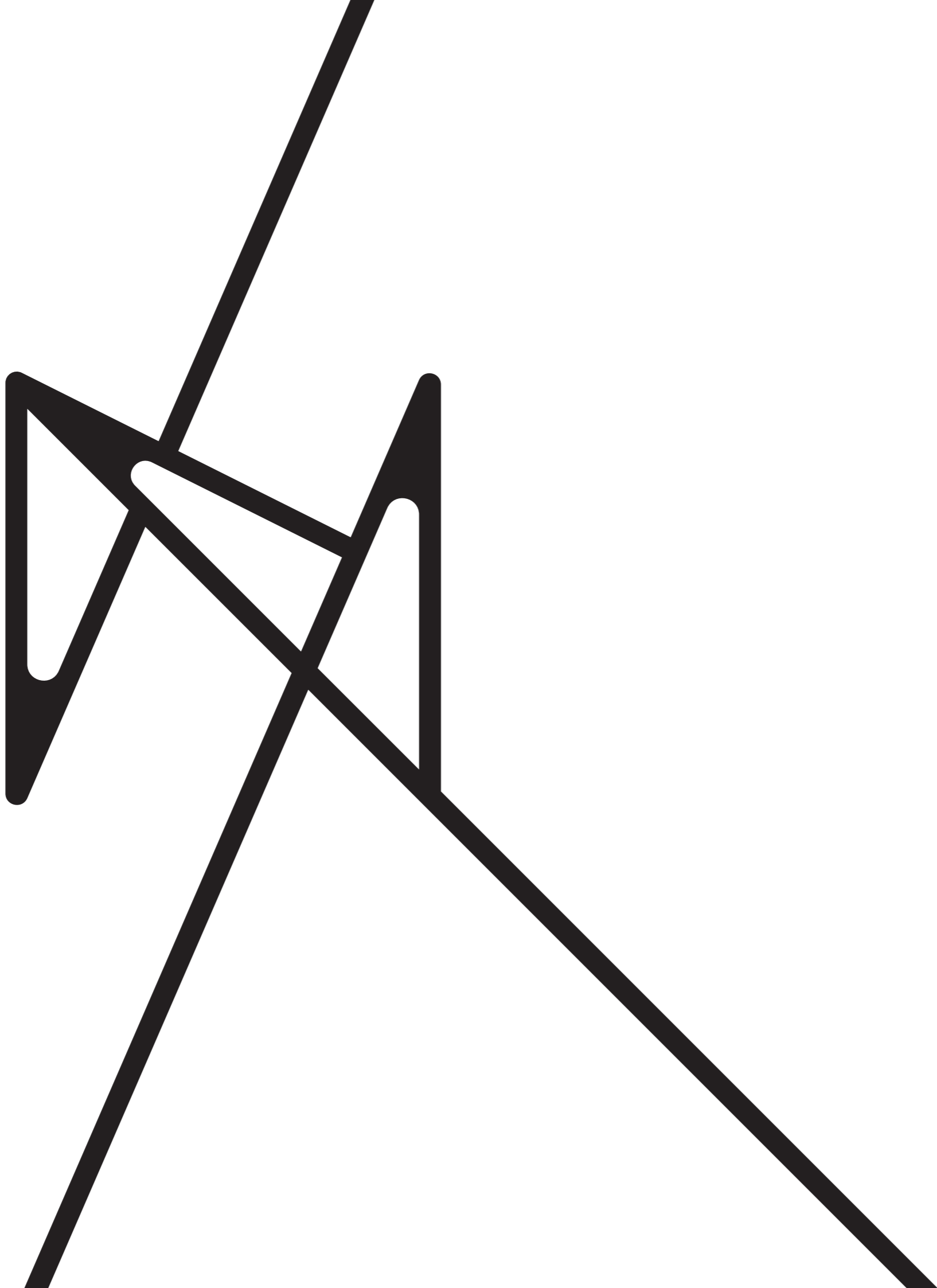

Novelties
01.2023



LVM TRACK 2M
10163

LVM FOCUS OUT LED 15 W
10151

LVM LINE LED 9W
10143

LVM RECESSED TRACK 2M
10157

LVM TRACK 2M
10163

LVM - LOW VOLTAGE MAGNETIC TRACK LIGHT SYSTEM



LVM FOCUS LED 15W
10150



LVM FOCUS LED 9W
10144

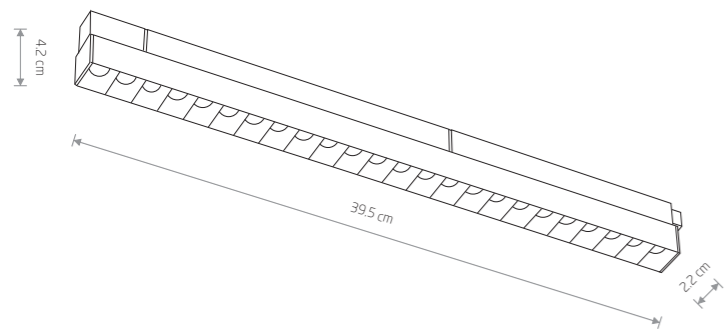

LVM FOCUS LED 15W

■ painted aluminum, plastic

■ 10150

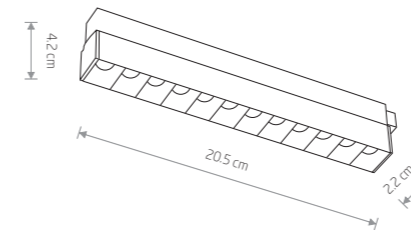

LVM FOCUS LED 9W

■ painted aluminum, plastic

■ 10144



Item No.	Power	Colour temp.	Luminous flux	Beam angle	Colour Rendering Index (CRI)	Voltage DC	Safety type	Ingress protection	Lifetime
10150	15W LED	3000K	1300 lm	30°	>90	48V	⚡	IP20	30000h

Item No.	Power	Colour temp.	Luminous flux	Beam angle	Colour Rendering Index (CRI)	Voltage DC	Safety type	Ingress protection	Lifetime
10144	9W LED	3000K	800 lm	30°	>90	48V	⚡	IP20	30000h

■ BLACK

■ BLACK



LVM FOCUS OUT LED 15W
10151



LVM FOCUS OUT LED 9W
10145

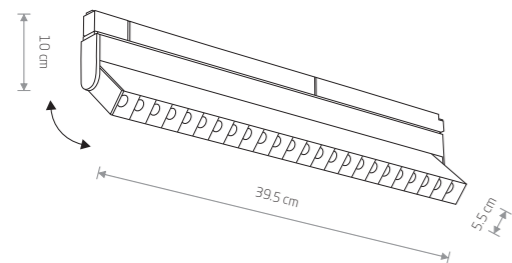

LVM FOCUS OUT LED 15W

■ painted aluminum, plastic

■ 10151

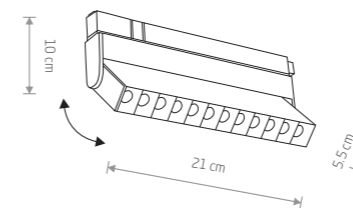

LVM FOCUS OUT LED 9W

■ painted aluminum, plastic

■ 10145



Item No.	Power	Colour temp.	Luminous flux	Beam angle	Colour Rendering Index (CRI)	Voltage DC	Safety type	Ingress protection	Lifetime
10151	15W LED	3000K	1300 lm	30°	>90	48V	⚡	IP20	30000h

Item No.	Power	Colour temp.	Luminous flux	Beam angle	Colour Rendering Index (CRI)	Voltage DC	Safety type	Ingress protection	Lifetime
10145	9W LED	3000K	800 lm	30°	>90	48V	⚡	IP20	30000h

■ BLACK

■ BLACK

LVM LINE LED 15W
10148

LVM LINE LED 9W
10143

LVM LID LED 8W
10152

LVM TRUCK 2M
10163





LVM LINE LED 15W
10148



LVM LINE LED 9W
10143

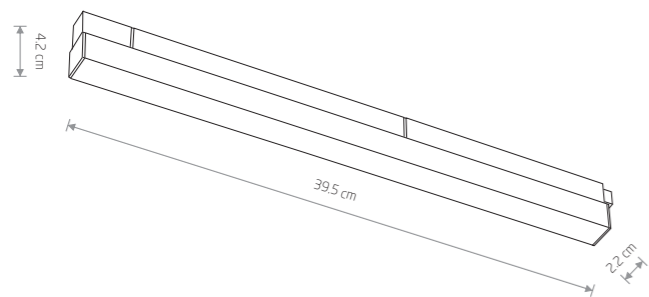

LVM LINE LED 15W
painted aluminum, plastic

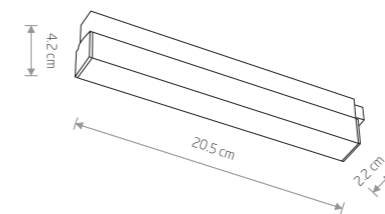
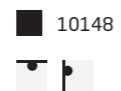

LVM LINE LED 9W
painted aluminum, plastic

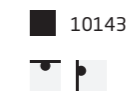

Item No.	Power	Colour temp.	Luminous flux	Beam angle	Colour Rendering Index (CRI)	Voltage DC	Safety type	Ingress protection	Lifetime
10148	15W LED	3000K	700 lm	110°	>90	48V	⚡	IP20	30000h

Item No.	Power	Colour temp.	Luminous flux	Beam angle	Colour Rendering Index (CRI)	Voltage DC	Safety type	Ingress protection	Lifetime
10143	9W LED	3000K	400 lm	110°	>90	48V	⚡	IP20	30000h



LVM SPOT LED 15W
10147



LVM SPOT LED 9W
10142

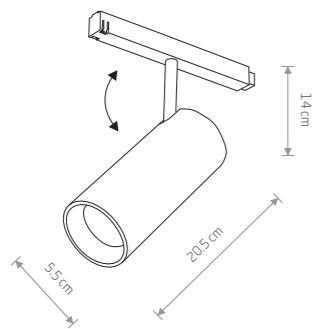

LVM SPOT LED 15W

painting aluminum, plastic

■ 10147

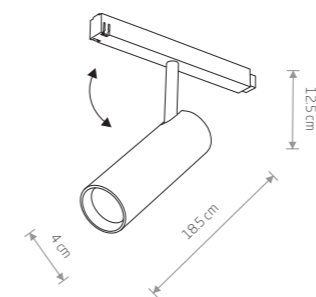

LVM SPOT LED 9W

painting aluminum, plastic

■ 10142



Item No.	Power	Colour temp.	Luminous flux	Beam angle	Colour Rendering Index (CRI)	Voltage DC	Safety type	Ingress protection	Lifetime
10147	15W LED	3000K	1020 lm	30°	>90	48V	⚡	IP20	30000h

Item No.	Power	Colour temp.	Luminous flux	Beam angle	Colour Rendering Index (CRI)	Voltage DC	Safety type	Ingress protection	Lifetime
10142	9W LED	3000K	780 lm	30°	>90	48V	⚡	IP20	30000h

■ BLACK

■ BLACK

LVM RECESSED TRACK 2M
10157

LVM FOCUS OUT LED 9W
10145

LVM FOCUS OUT LED 15W
10151

LVM ROLLER LED 9W
10146



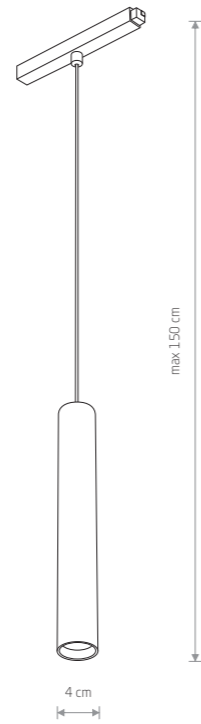
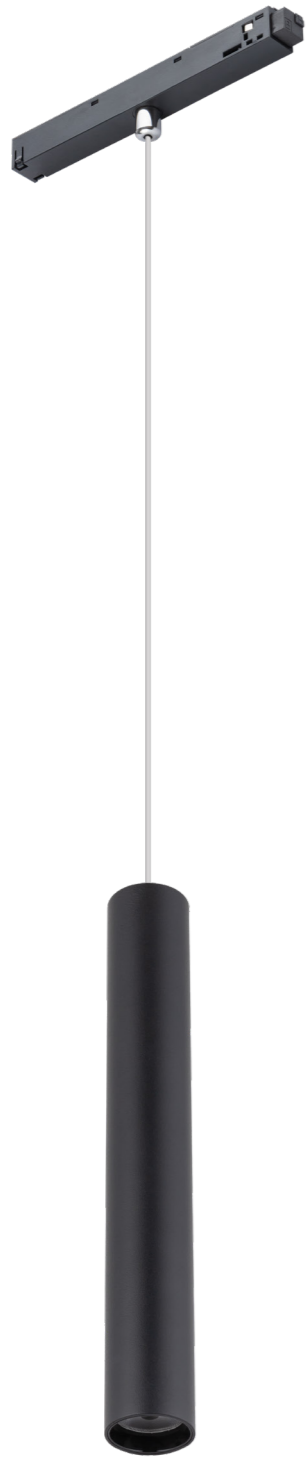

LVM ROLLER LED 9W
 painted aluminum, plastic

■ 10146



LVM ROLLER LED 9W
 10146



Item No.	Power	Colour temp.	Luminous flux	Beam angle	Colour Rendering Index (CRI)	Voltage DC	Safety type	Ingress protection	Lifetime
10146	9W LED	3000K	620 lm	36°	>90	48V	⚡	IP20	30000h

■ BLACK

LVM FOCUS OUT LED 15W
10151

LVM SPOT LED 15W
10147

LVM FOCUS OUT LED 9W
10145

LVM SLOT LED 5W
10154



LVM SLOT LED 5W
10154



LVM SLOT LED 8W
10155

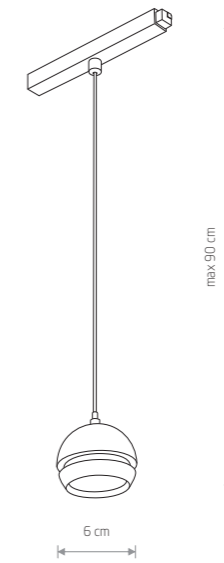
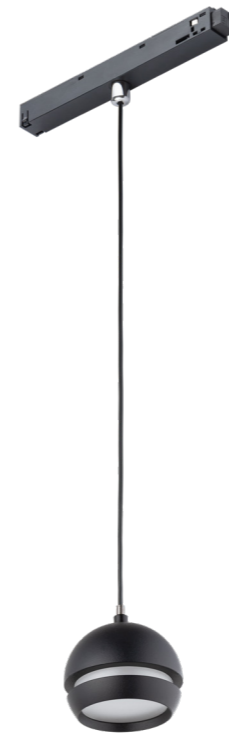

LVM SLOT LED 5W
painted aluminum, plastic PMMA

■ 10154

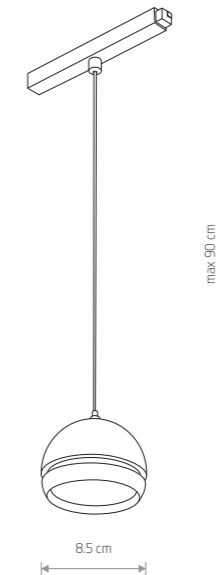

LVM SLOT LED 8W
painted aluminum, plastic PMMA

■ 10155



Item No.	Power	Colour temp.	Luminous flux	Beam angle	Colour Rendering Index (CRI)	Voltage DC	Safety type	Ingress protection	Lifetime
10154	5W LED	3000K	210 lm	100°	>90	48V	⚡	IP20	30000h
10155	8W LED	3000K	370 lm	100°	>90	48V	⚡	IP20	30000h

■ BLACK

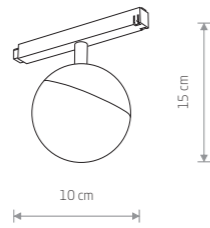

LVM LID LED 8W
 painted aluminum, plastic PMMA

■ 10152

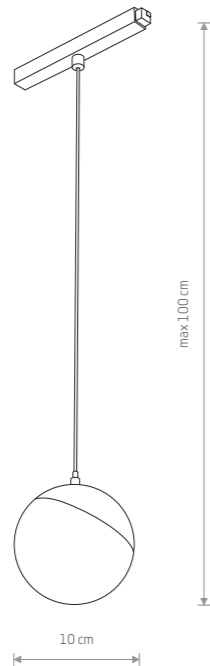
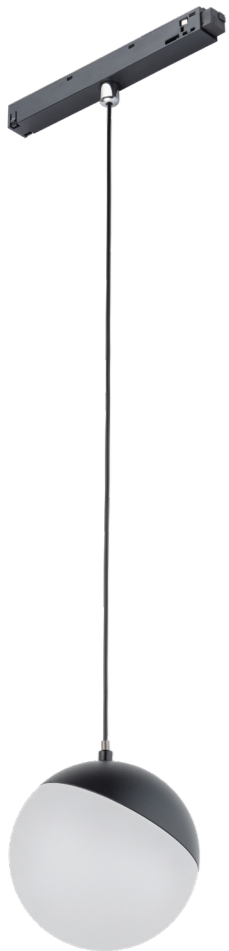

LVM LID LED 8W
 painted aluminum, plastic PMMA

■ 10153



LVM LID LED 8W
 10153

Item No.	Power	Colour temp.	Luminous flux	Beam angle	Colour Rendering Index (CRI)	Voltage DC	Safety type	Ingress protection	Lifetime
10152	8W LED	3000K	650 lm	160°	>90	48V	⚡	IP20	30000h
10153	8W LED	3000K	650 lm	160°	>90	48V	⚡	IP20	30000h

■ BLACK □ WHITE

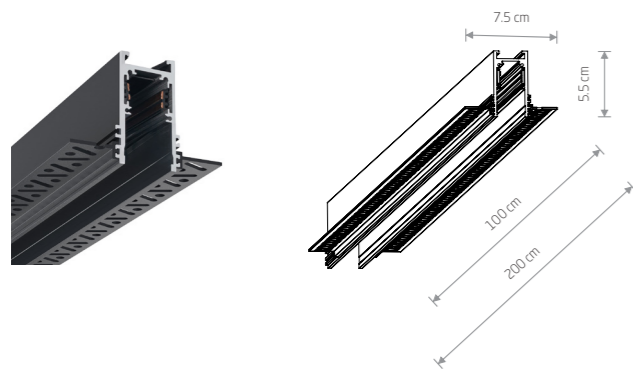

LVM RECESSED TRACK 1M

aluminum

■ 10156

LVM RECESSED TRACK 2M

aluminum

■ 10157

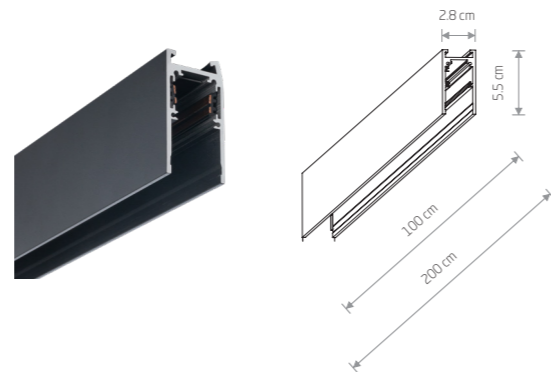

LVM TRACK 1M

aluminum

■ 10162

LVM TRACK 2M

aluminum

■ 10163

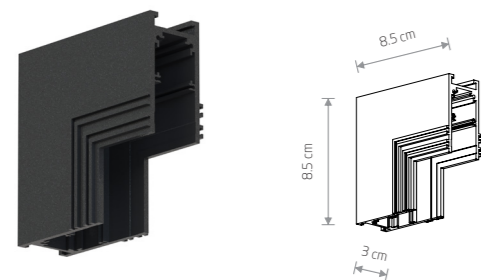

LVM RECESSED INSIDE CORNER

aluminum

■ 10160

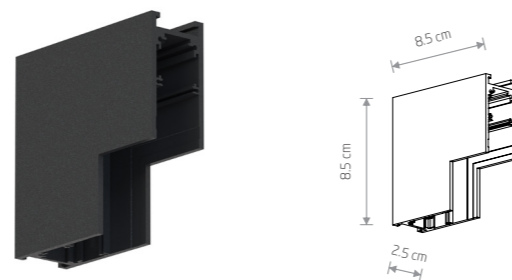

LVM INSIDE CORNER

aluminum

■ 10165

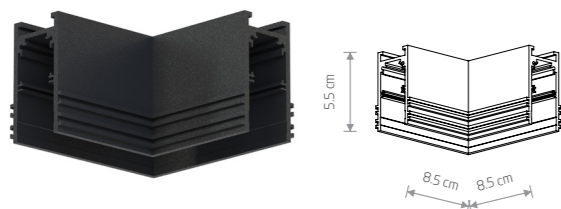

LVM RECESSED HORIZONTAL CORNER

aluminum

■ 10158

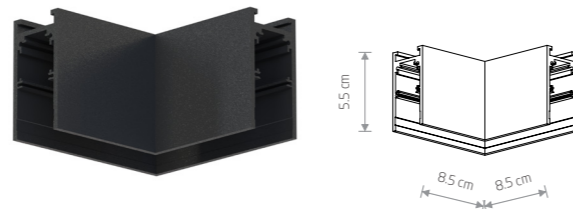

LVM HORIZONTAL CORNER

aluminum

■ 10164

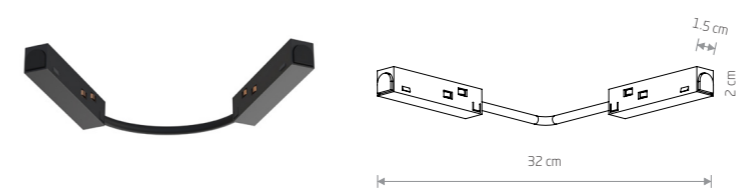

LVM CORNER CONDUCTIVE MODULE

plastic

■ 10166

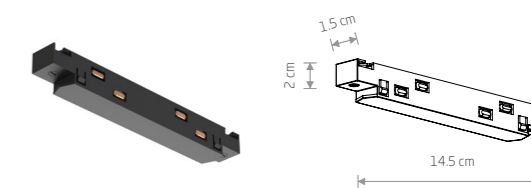

LVM STRAIGHT CONDUCTIVE MODULE

plastic

■ 10167

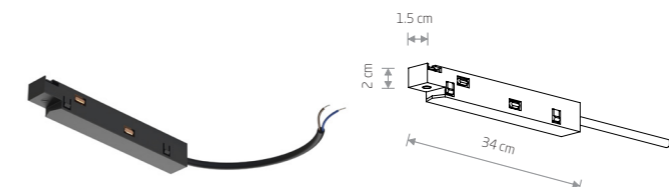

LVM OUTSIDE POWER SUPPLY CONDUCTIVE MODULE

plastic

■ 10168

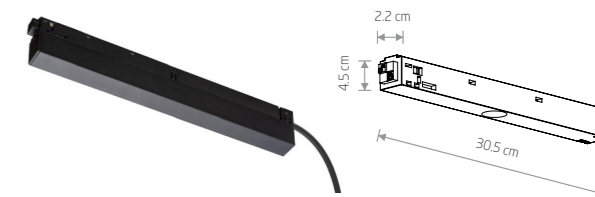

LVM 48V, 150W, INSIDE POWER SUPPLY

aluminum

■ 10161

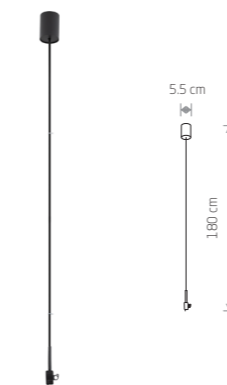

LVM POWER SUPPLY KIT

plastic, painted steel

■ 10597

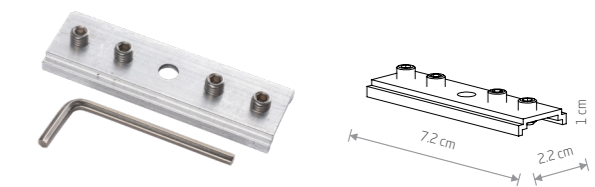

LVM TRUCK BUCKLE CONNECTOR

steel

■ 10171



LVM SUSPENSION KIT

steel

■ 10170

MIDI LED 10055



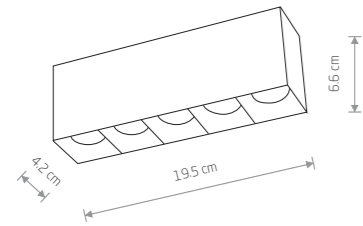

MIDI LED

painted aluminum

10048 3000K 10052 4000K

10055 3000K 10058 4000K

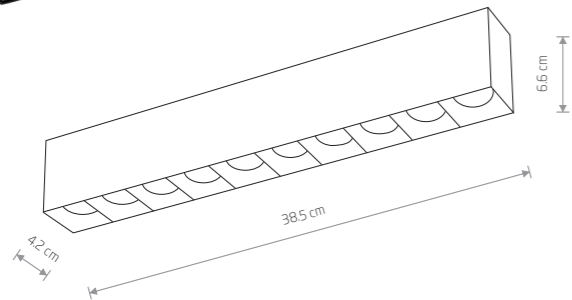

MIDI LED

painted aluminum

10050 3000K 10053 4000K

10056 3000K 10060 4000K



Item No.	Power	Colour temp.	Luminous flux	Beam angle	Colour Rendering Index (CRI)	Input	Safety type	Power factor	Ingress protection	Lifetime
10048	20W LED	3000K	1700 lm	36°	>90	220-230 V, 50/60 Hz	☐	>0.5	IP20	30000h
10052	20W LED	4000K	1800 lm	36°	>90	220-230 V, 50/60 Hz	☐	>0.5	IP20	30000h
10055	20W LED	3000K	1700 lm	36°	>90	220-230 V, 50/60 Hz	☐	>0.5	IP20	30000h
10058	20W LED	4000K	1700 lm	36°	>90	220-230 V, 50/60 Hz	☐	>0.5	IP20	30000h
10050	40W LED	3000K	3500 lm	36°	>90	220-230 V, 50/60 Hz	☐	>0.9	IP20	30000h
10053	40W LED	4000K	3500 lm	36°	>90	220-230 V, 50/60 Hz	☐	>0.9	IP20	30000h
10056	40W LED	3000K	3500 lm	36°	>90	220-230 V, 50/60 Hz	☐	>0.9	IP20	30000h
10060	40W LED	4000K	3500 lm	36°	>90	220-230 V, 50/60 Hz	☐	>0.9	IP20	30000h

☐ WHITE ■ BLACK





MIDI LED 10047

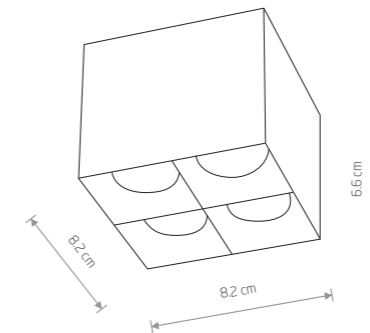

MIDI LED

painted aluminum

10047 3000K 10051 4000K

10054 3000K 10057 4000K



Item No.	Power	Colour temp.	Luminous flux	Beam angle	Colour Rendering Index (CRI)	Input	Safety type	Power factor	Ingress protection	Lifetime
10047	16W LED	3000K	1500 lm	36°	>90	220-230 V, 50/60 Hz	□	>0.5	IP20	30000h
10051	16W LED	4000K	1540 lm	36°	>90	220-230 V, 50/60 Hz	□	>0.5	IP20	30000h
10054	16W LED	3000K	1500 lm	36°	>90	220-230 V, 50/60 Hz	□	>0.5	IP20	30000h
10057	16W LED	4000K	1540 lm	36°	>90	220-230 V, 50/60 Hz	□	>0.5	IP20	30000h

□ WHITE ■ BLACK

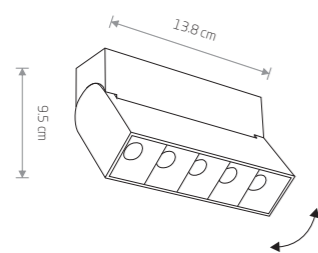

FOCUS MINI LED

painting aluminum

- 10067 3000K
 10070 4000K
- 10068 3000K
 10071 4000K



FOCUS MINI LED
10071

Item No.	Power	Colour temp.	Luminous flux	Beam angle	Colour Rendering Index (CRI)	Input	Safety type	Power factor	Ingress protection	Lifetime
10067	10W LED	3000K	600 lm	36 °	>90	220-230 V, 50/60 Hz	☐	>0,9	IP20	30000h
10070	10W LED	4000K	600 lm	36 °	>90	220-230V V, 50/60 Hz	☐	>0,9	IP20	30000h
10068	10W LED	3000K	600 lm	36 °	>90	220-230 V, 50/60 Hz	☐	>0,9	IP20	30000h
10071	10W LED	4000K	600 lm	36 °	>90	220-230 V, 50/60 Hz	☐	>0,9	IP20	30000h

WHITE
 BLACK



MINI LED RECESSED
10042

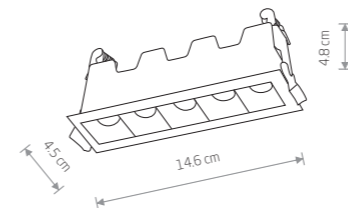

MINI LED RECESSED

painting aluminum

10042 3000K 10043 4000K



cut out 140x35 mm

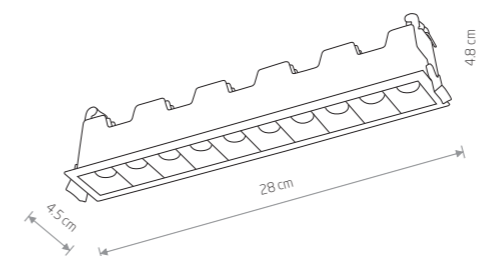

MINI LED RECESSED

painting aluminum

10045 3000K 10046 4000K



cut out 275x35 mm

Item No.	Power	Colour temp.	Luminous flux	Beam angle	Colour Rendering Index (CRI)	Input	Safety type	Power factor	Ingress protection	Lifetime
10042	10W LED	3000K	600 lm	30°	>90	~220-230 V, 50/60 Hz	□	>0.5	IP20	30000h
10043	10W LED	4000K	660 lm	30°	>90	~220-230 V, 50/60 Hz	□	>0.5	IP20	30000h
10045	20W LED	3000K	1220 lm	30°	>90	220-230 V, 50/60 Hz	□	>0.9	IP20	30000h
10046	20W LED	4000K	1280 lm	30°	>90	~220-230 V, 50/60 Hz	□	>0.9	IP20	30000h

WHITE BLACK

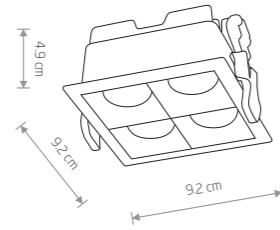

MIDI LED RECESSED

■ painted aluminum

■ 10061 3000K ■ 10064 4000K



✓ cut out 85×85 mm

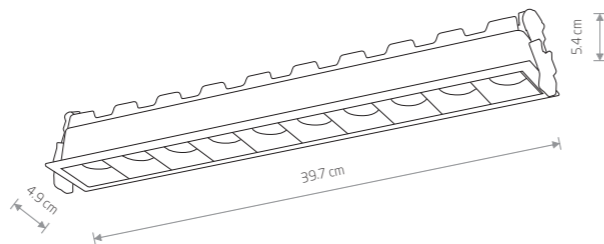
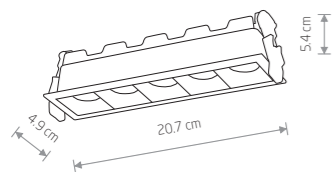
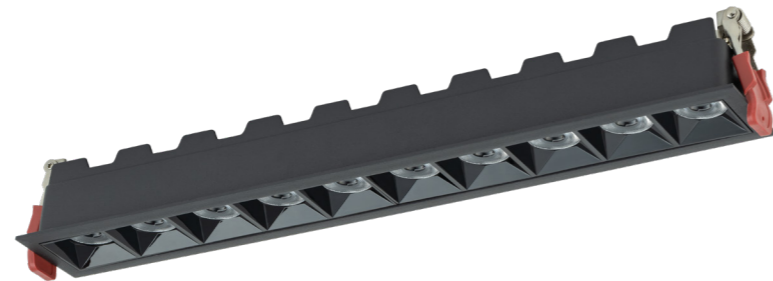

MIDI LED RECESSED

■ painted aluminum

■ 10062 3000K ■ 10065 4000K



✓ cut out 200×45 mm

MIDI LED RECESSED

■ painted aluminum

■ 10063 3000K ■ 10066 4000K



✓ cut out 390×45 mm

Item No.	Power	Colour temp.	Luminous flux	Beam angle	Colour Rendering Index (CRI)	Input	Safety type	Power factor	Ingress protection	Lifetime
10061	16W LED	3000K	1400 lm	36°	>90	220-230 V, 50/60 Hz	☐	>0.5	IP20	30000h
10064	16W LED	4000K	1400 lm	36°	>90	220-230 V, 50/60 Hz	☐	>0.5	IP20	30000h
10062	20W LED	3000K	1800 lm	36°	>90	220-230 V, 50/60 Hz	☐	>0.5	IP20	30000h
10065	20W LED	4000K	1830 lm	36°	>90	220-230 V, 50/60 Hz	☐	>0.5	IP20	30000h
10063	40W LED	3000K	3300 lm	36°	>90	220-230 V, 50/60 Hz	☐	>0.9	IP20	30000h
10066	40W LED	4000K	3300 lm	36°	>90	220-230 V, 50/60 Hz	☐	>0.9	IP20	30000h

■ BLACK



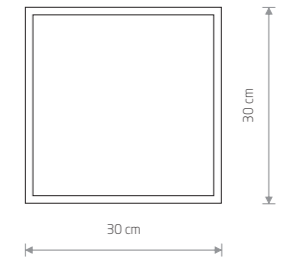

QUAD

painted steel, plastic PMMA

□ 10470 ■ 10471

☐ 4xGX53, max 10W only LED

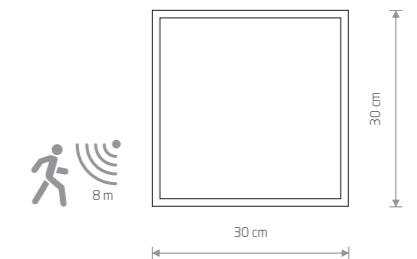

QUAD SENSOR

painted steel, plastic PMMA

□ 10472 ■ 10473

☐ 4xGX53, max 10W only LED

□ WHITE P004 RAL 9003 ■ BLACK P013 RAL 9005



MONO DEEP 10466

MONO DEEP 10468

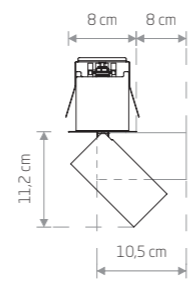
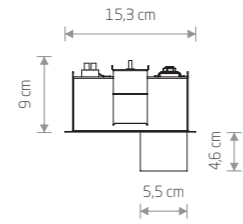

MONO DEEP

painted steel, plastic PC

10464 10458

1xGU10, max 10W only LED

cut out 64x138 mm

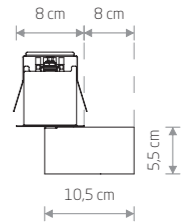

MONO DEEP

chrome plated steel, plastic PC

10467 10462

4xGU10, max 10W only LED

cut out 64x685 mm

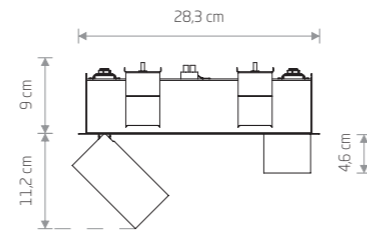
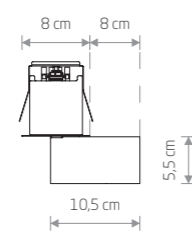
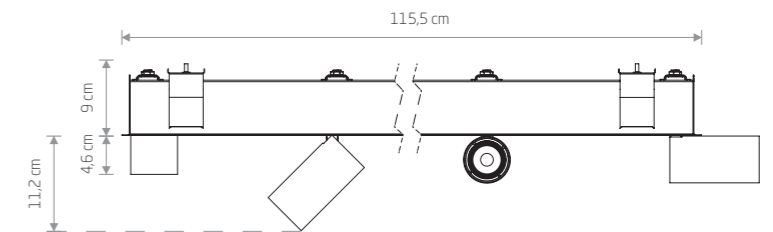

MONO DEEP

painted steel, plastic PC

10465 10460

2xGU10, max 10W only LED

cut out 64x268 mm

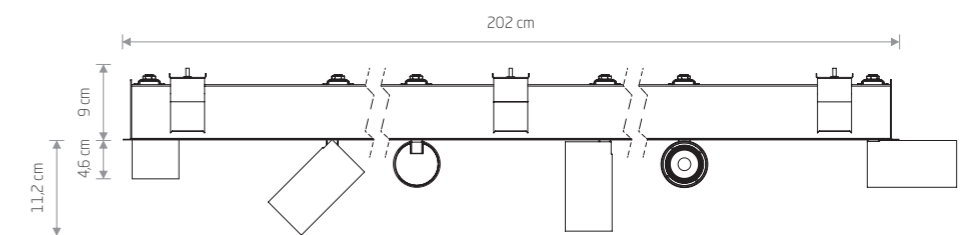
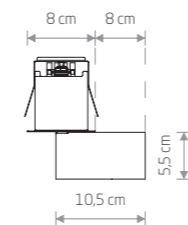
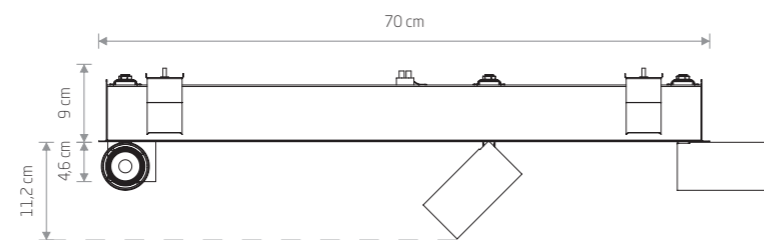
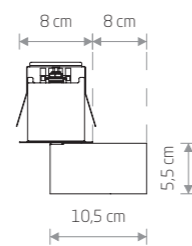

MONO DEEP

painted steel, plastic PC

10466 10461

3xGU10, max 10W only LED

cut out 64x685 mm

MONO DEEP

painted steel, plastic PC

10468 10463

6xGU10, max 10W only LED

cut out 64x2002 mm



CAMELEON ADAPTER CTLS
8281

CTLS TRACK 8716

CTLS MONO 10237

CAMELEON CABLE G9
8632

CAMELEON LASER 490
10248

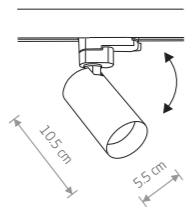

CTLS MONO

painting steel, plastic ABS

- 10235
- 10236
- 10238
- 10239

1xGU10, max 10W only LED

solid brass, plastic ABS

- 10237

1xGU10, max 10W only LED

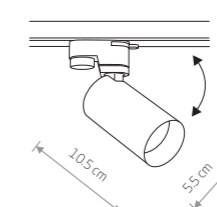

PROFILE MONO

painting steel, plastic ABS

- 7581
- 7582
- 7584
- 7585

1xGU10, max 10W only LED

solid brass, painting steel, plastic ABS

- 7583

1xGU10, max 10W only LED

PROFILE PUCK
10358

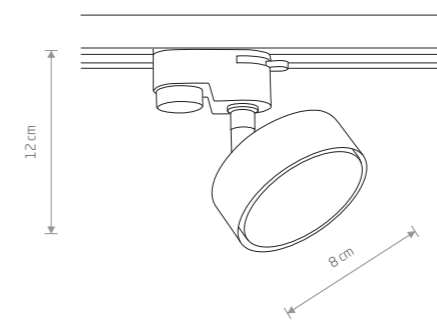
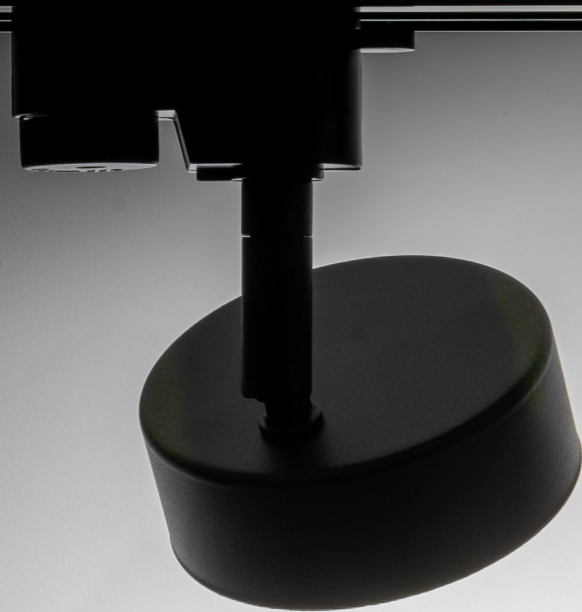

PROFILE PUCK
painted steel, plastic PC

■ 10358

☐ 1xGX53, max 8W



VERTIC LED 10362

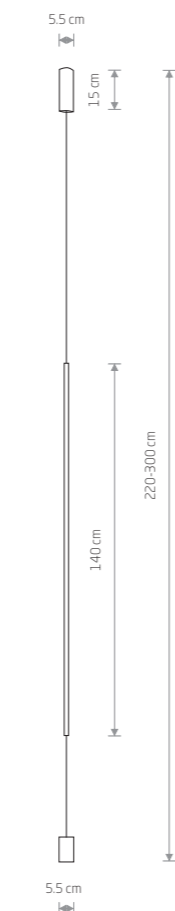

VERTIC LED

■ painted aluminum, plastic PP

■ 10362



SPIN LED M 10370

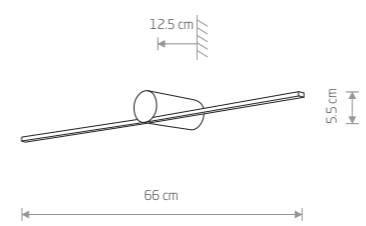

SPIN LED S

■ painted aluminum, plastic PP

■ 10368

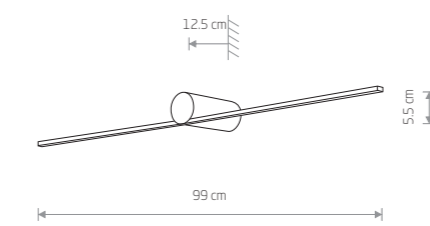

SPIN LED M

■ painted aluminum, plastic PP

■ 10370

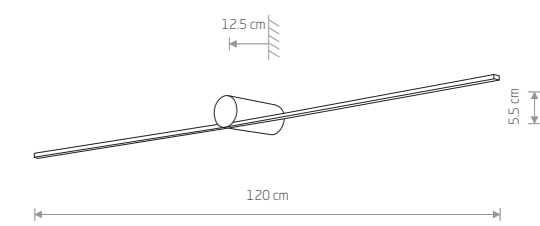

SPIN LED L

■ painted aluminum, plastic PP

■ 10371



Item No.	Power	Colour temp.	Luminous flux	Beam angle	Colour Rendering Index (CRI)	Input	Safety type	Power factor	Ingress protection	Lifetime
10368	9W LED	3000K	270 lm	100°	>90	~220-230 V, 50/60 Hz	☐	>0.5	IP20	50000h
10370	14W LED	3000K	420 lm	100°	>90	~220-230 V, 50/60 Hz	☐	>0.5	IP20	50000h
10371	17W LED	3000K	510 lm	100°	>90	~220-230 V, 50/60 Hz	☐	>0.5	IP20	50000h
10362	20W LED	3000K	600 lm	100°	>90	~220-230V V, 50/60 Hz	☐	>0.5	IP20	50000h

■ BLACK P013 RAL 9005

MOTIVE LED L 10313

MOTIVE LED M 10311

BAR LED M 10364

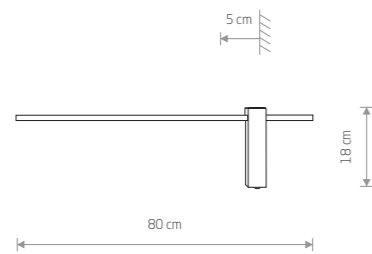

MOTIVE LED M

■ painted aluminum, plastic PP

■ 10311

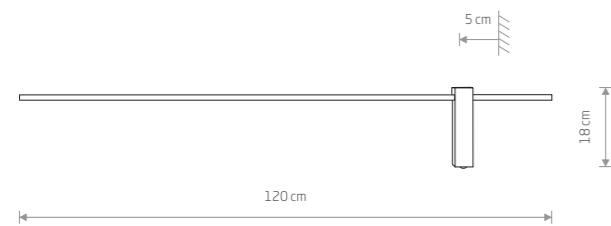

MOTIVE LED L

■ painted aluminum, plastic PP

■ 10313

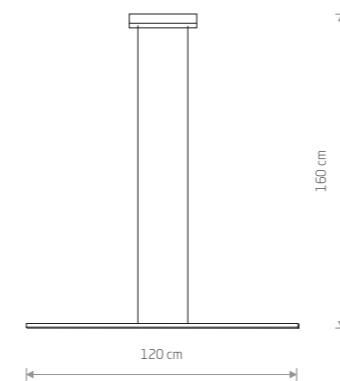

BAR LED S

■ painted aluminum, plastic PP

■ 10363

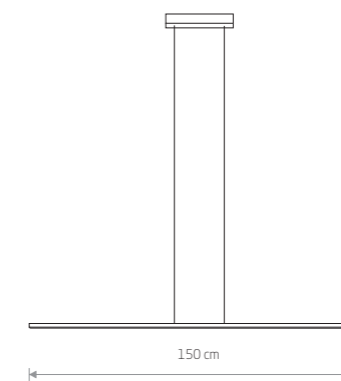

BAR LED M

■ painted aluminum, plastic PP

■ 10364

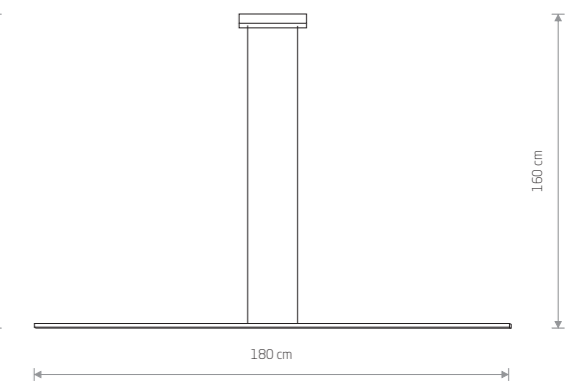

BAR LED L

■ painted aluminum, plastic PP

■ 10365



Item No.	Power	Colour temp.	Luminous flux	Beam angle	Colour Rendering Index (CRI)	Input	Safety type	Power factor	Ingress protection	Lifetime
10311	11W LED	3000K	330 lm	100°	>90	~220-230 V, 50/60 Hz	■	>0.5	IP20	50000h
10313	17W LED	3000K	510 lm	100°	>90	~220-230 V, 50/60 Hz	■	>0.5	IP20	50000h

Item No.	Power	Colour temp.	Luminous flux	Beam angle	Colour Rendering Index (CRI)	Input	Safety type	Power factor	Ingress protection	Lifetime
10363	24W LED	3000K	800 lm	100°	>80	~220-230V V, 50/60 Hz	■	>0.5	IP20	50000h
10364	30W LED	3000K	1000 lm	100°	>80	~220-230V V, 50/60 Hz	■	>0.5	IP20	50000h
10365	36W LED	3000K	1200 lm	100°	>80	~220-230V V, 50/60 Hz	■	>0.5	IP20	50000h

LASER 750
10447

LASER 490
10453

LASER 1000
10446

LASER 1000
10444



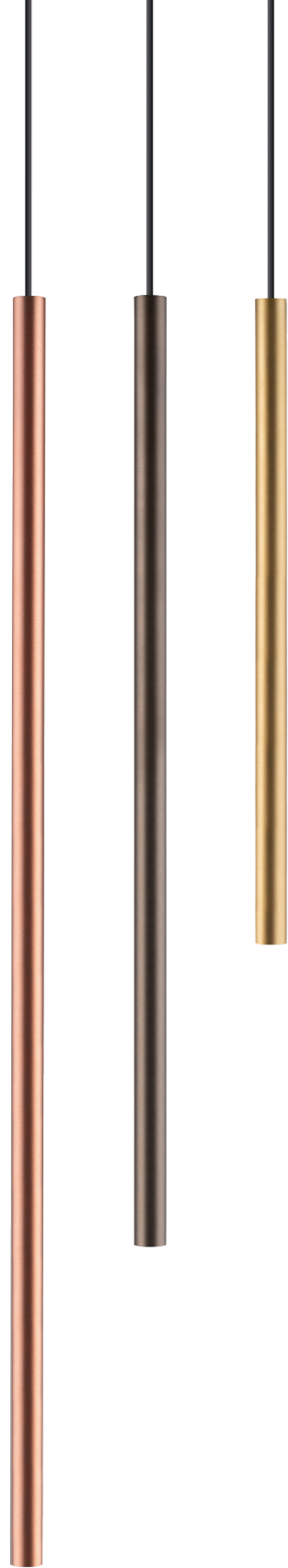

LASER 490

painting steel

- 10451
- 10452
- 10453

1xG9, max 10W only LED

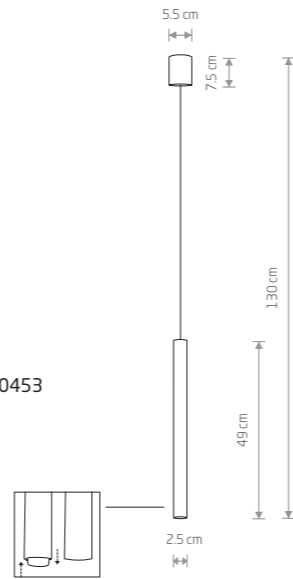

LASER 1000

painting steel

- 10444
- 10445
- 10446

1xG9, max 10W only LED

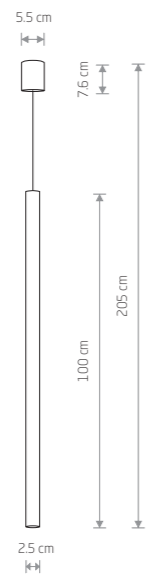

LASER 750

painting steel

- 10447
- 10448
- 10450

1xG9, max 10W only LED

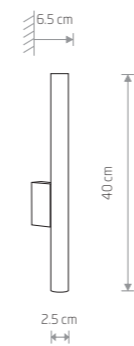
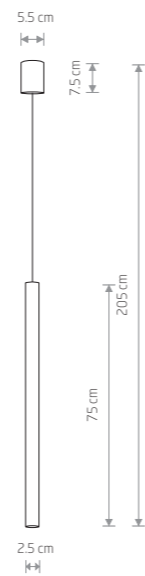

LASER WALL

painting steel

- 10563
- 10564
- 10562

2xG9, max 10W only LED

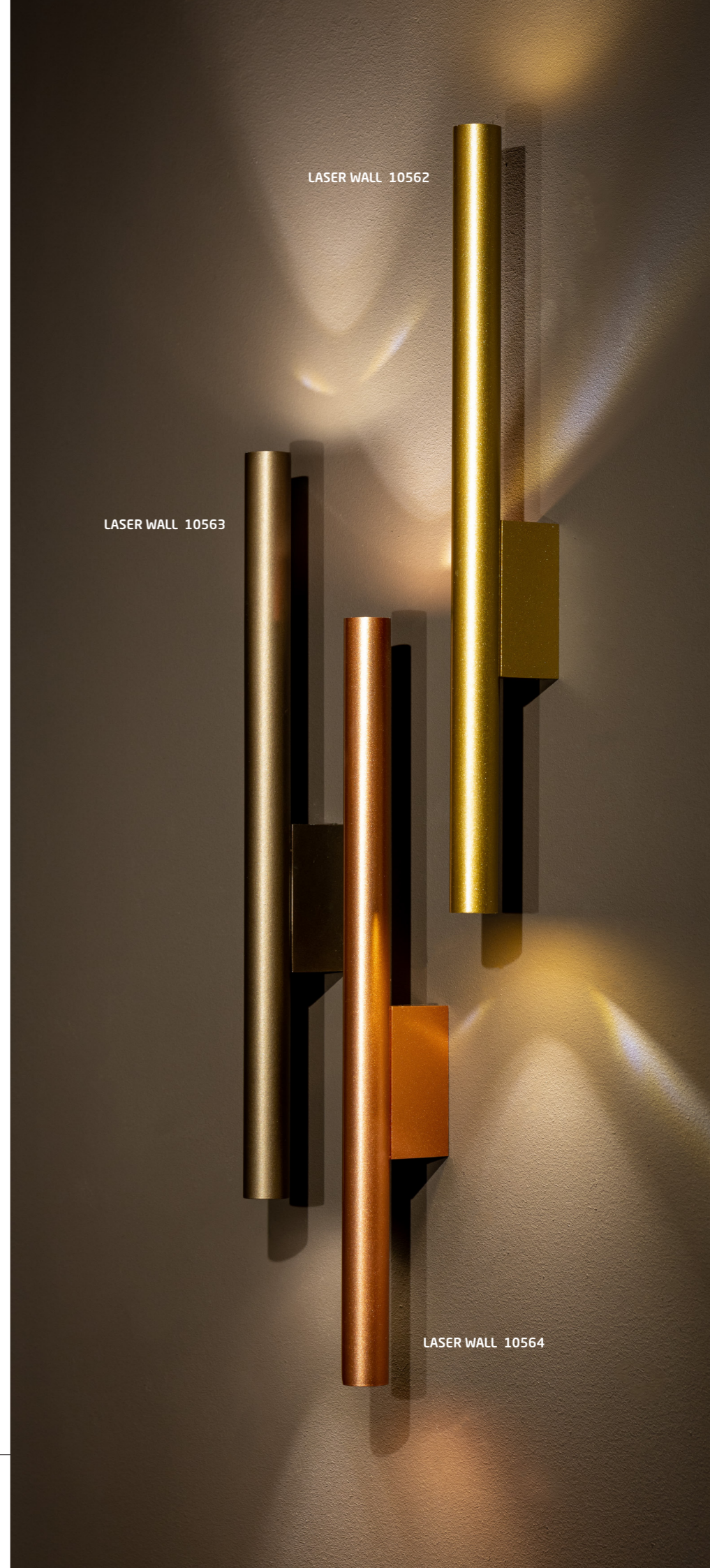

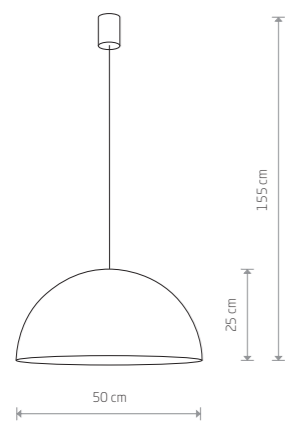
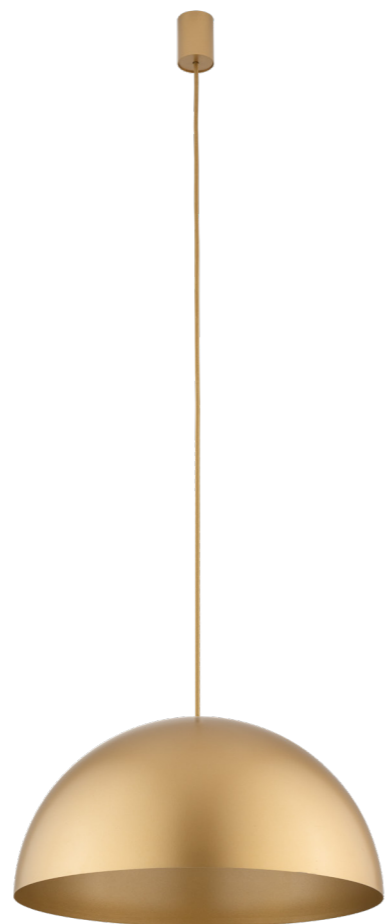

HEMISPHERE SUPER L
 painted steel, braided cable

■ 10296 ■ 10297 ■ 10298

⚡ 4xGX53, max 8W

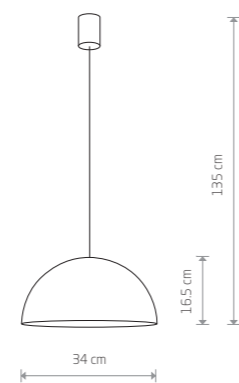

HEMISPHERE SUPER S
 painted steel, braided cable

■ 10618 ■ 10617 ■ 10616

⚡ 1xGX53, max 8W



HEMISPHERE SUPER L
 10296



CANDY 10295

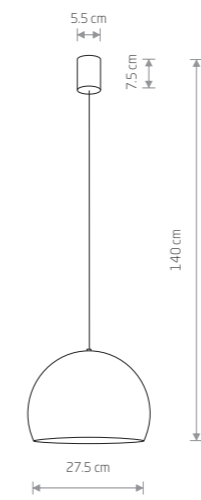

CANDY
painted steel

- 10293 10294 10295
- 10335 10334
- 1xGU10, max 10W



CANOE 10326

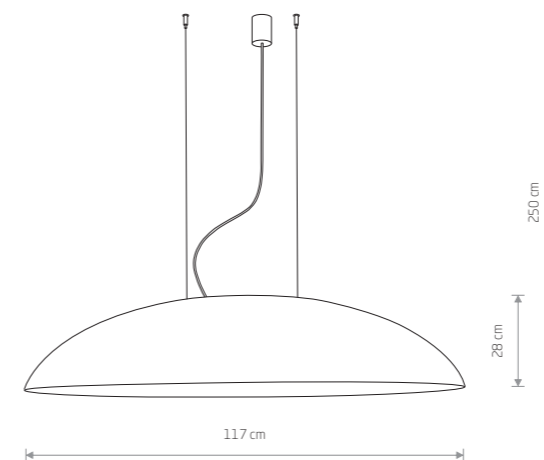

CANOE
composite, steel

10326 10322

5x E27, max 40W

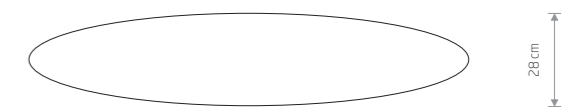

BLACK P014 RAL 9005 WHITE P003 RAL 9003 COPPER



EGG L 10320



EGG L 10324

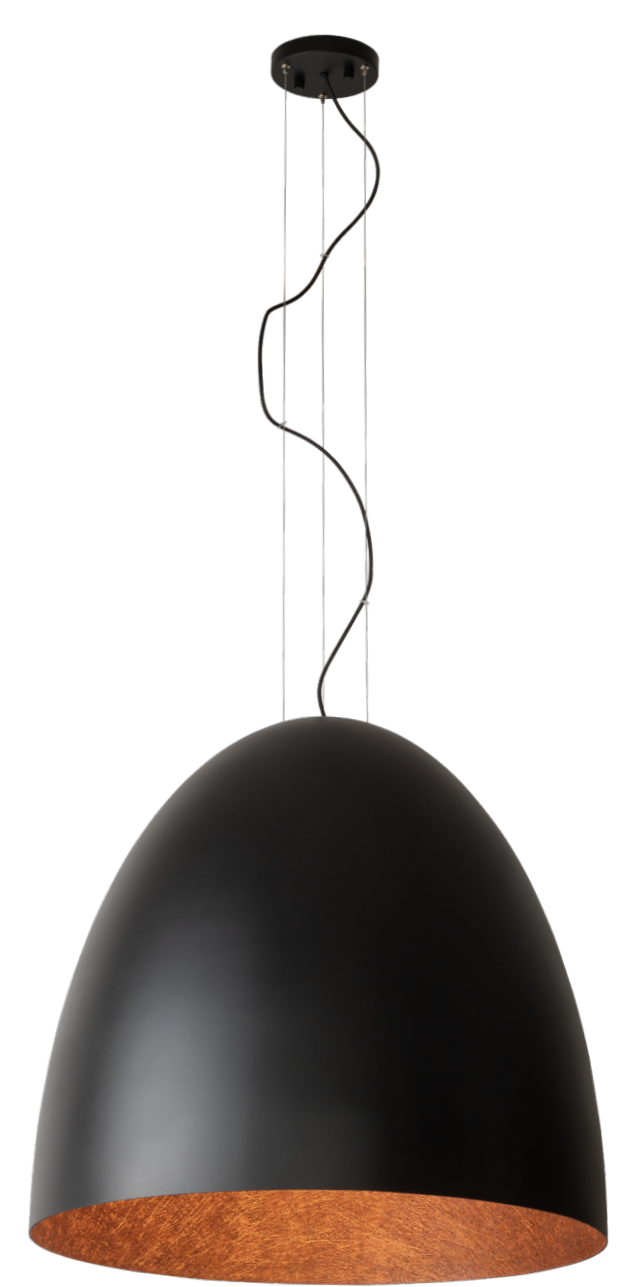

EGG XL 10321

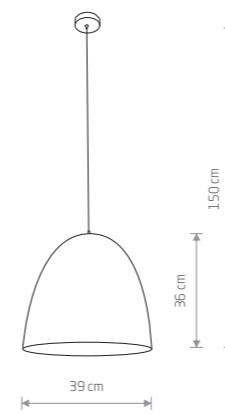

EGG M
composite, steel

10318 10323

1xE27, max 40W

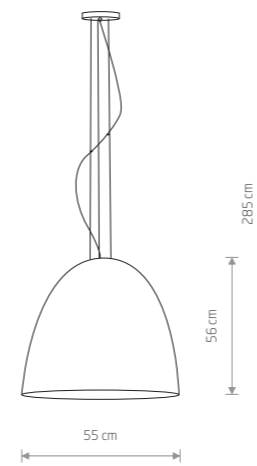

EGG L
composite, steel

10320 10324

5xE27, max 40W

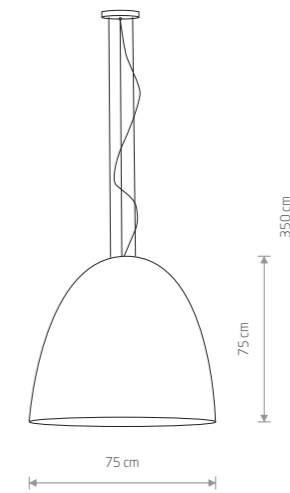

EGG XL
composite, steel

10321 10325

7xE27, max 40W

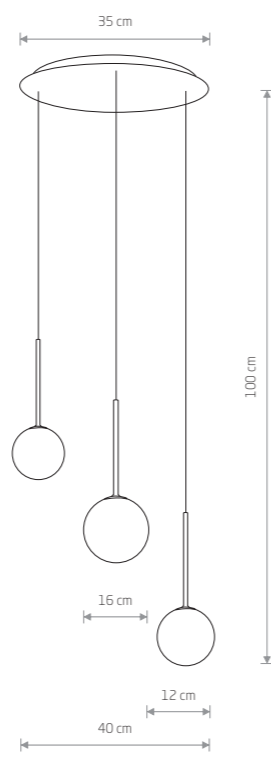
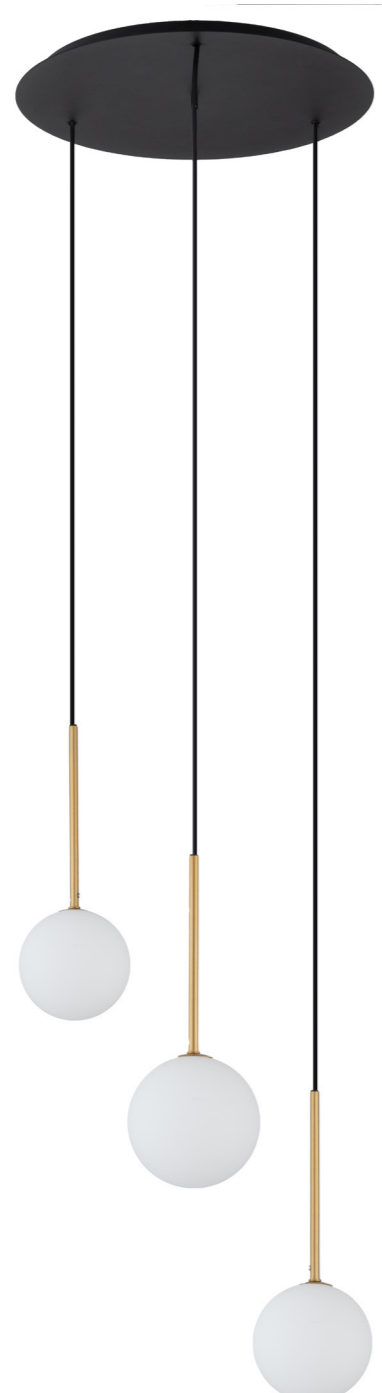

KARO
 painted steel, glass
 10304
 3xG9, max 12W

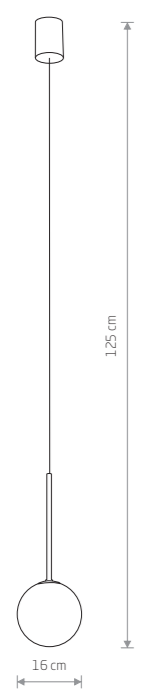

KARO
 painted steel, glass
 10305
 1xG9, max 12W

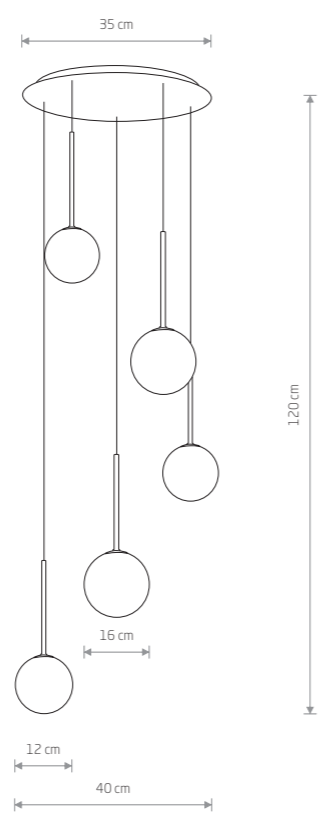

KARO
 painted steel, glass
 10303
 5xG9, max 12W



KARO 10303

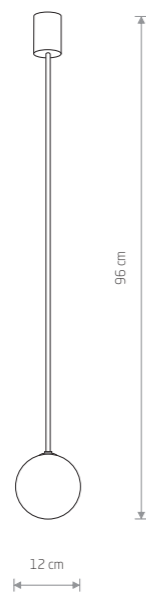

KIER M

painting steel, glass

10307 10306

1xG9, max 12W

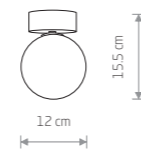

KIER S

painting steel, glass

10302

1xG9, max 12W

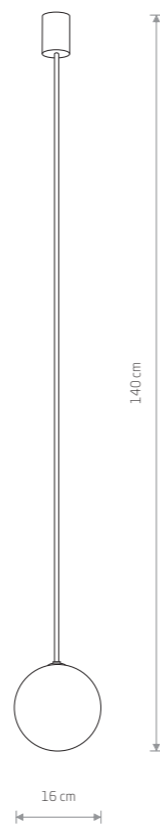

KIER L

painting steel, glass

10310 10308

1xG9, max 12W



PIK 10301

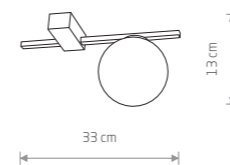

PIK

painting aluminum, glass

10299

1xG9, max 12W

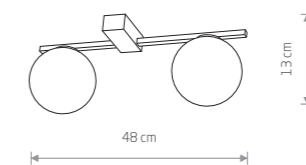

PIK

painting aluminum, glass

10300

2xG9, max 12W

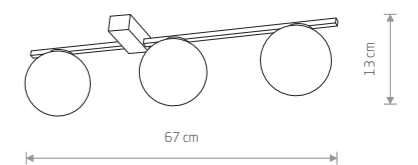

PIK

painting aluminum, glass

10301

3xG9, max 12W

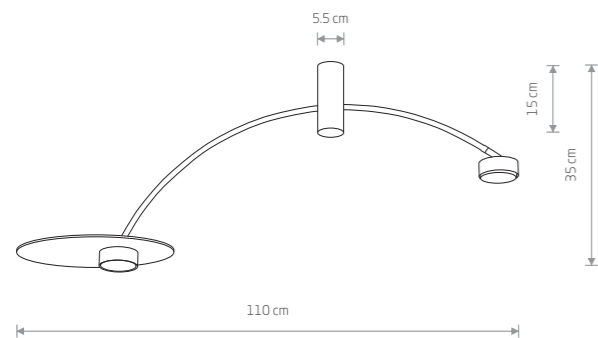

HEFT

■ painted steel, plywood

■ 10356

● 2xGX53, max 8W

HEFT 10356





SUNSET NATURAL A
10576

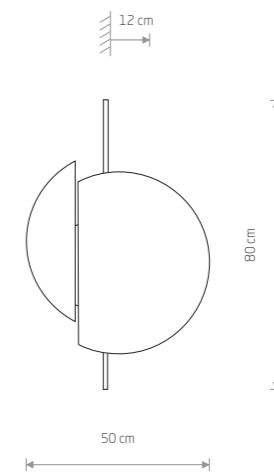

SUNSET NATURAL B
plywood, painted steel

10577

2xGX53, max 8W

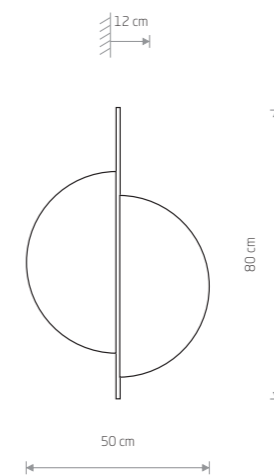

SUNSET NATURAL C
plywood, painted steel

10578

2xGX53, max 8W

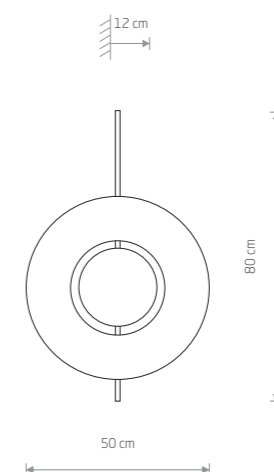

SUNSET NATURAL A
plywood, painted steel

10576

2xGX53, max 8W



KYMI C
plywood, painted steel, braided cable

10572 10575

1xE27, max 60W

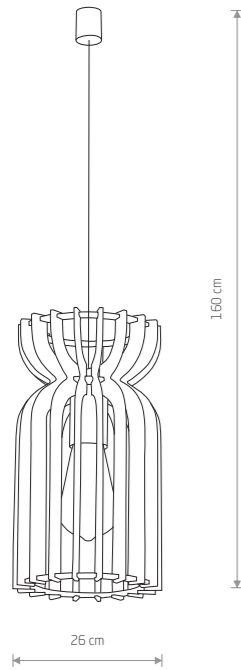

KYMI A
plywood, painted steel, braided cable

10570 10573

1xE27, max 60W

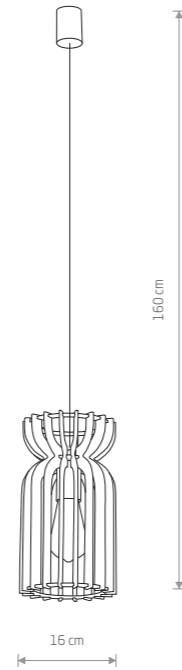

KYMI B
plywood, painted steel, braided cable

10571 10574

1xE27, max 60W



KYMI C 10575



BERGEN 10455

MALMO 10457

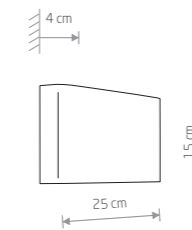

HAGA
aluminum

10456

2xG9, max 10W only LED

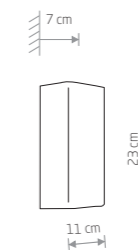

BERGEN
aluminum

10455

2xGU10, max 10W only LED



MALMO
aluminum

10457

2xGU10, max 10W only LED



RING LED M 10347

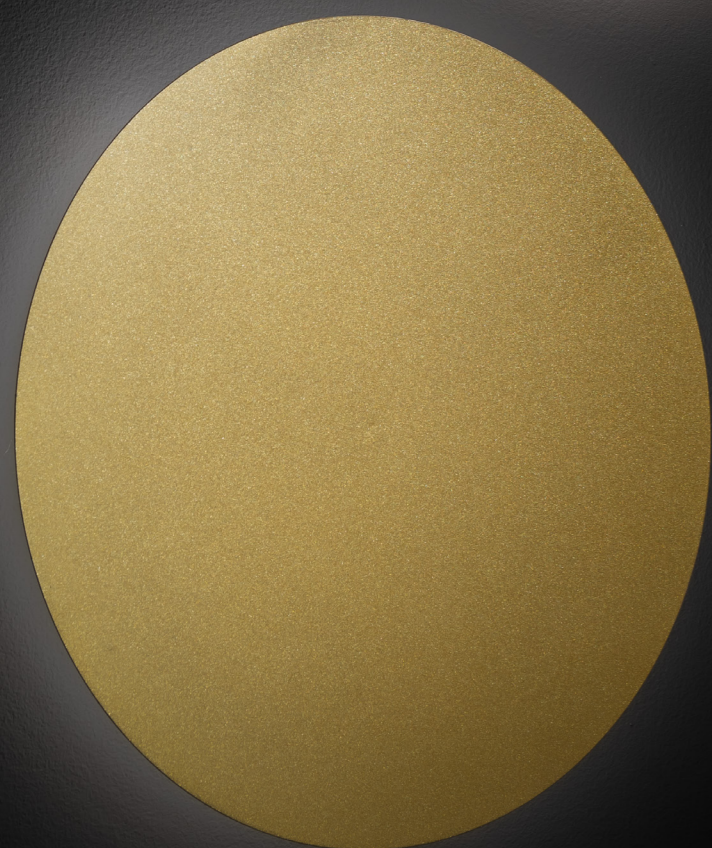

RING LED L 10351

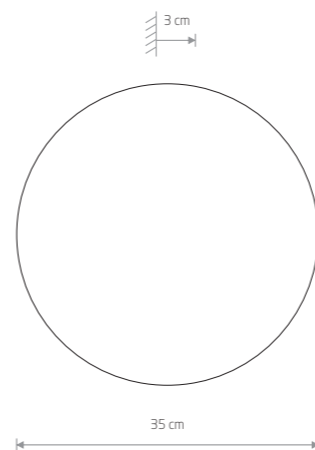

RING LED L

Painted steel

10353 10348 10351

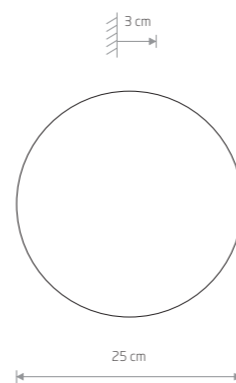

RING LED M

Painted steel

10352 10347 10350

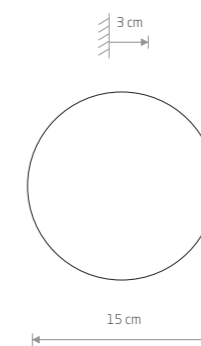

RING LED S

Painted steel

10315 10316 10317



Item No.	Power	Colour temp.	Luminous flux	Colour Rendering Index (CRI)	Input	Safety type	Power factor	Ingress protection	Lifetime
10315	7W LED	3000K	60 lm	>90	~220-230 V, 50/60 Hz	⊕	>0.5	IP20	50000h
10316	7W LED	3000K	60 lm	>90	~220-230 V, 50/60 Hz	⊖	>0.5	IP20	50000h
10317	7W LED	3000K	60 lm	>90	~220-230 V, 50/60 Hz	⊕	>0.5	IP20	50000h
10347	10W LED	3000K	150 lm	>90	~220-230 V, 50/60 Hz	⊕	>0.5	IP20	50000h
10350	10W LED	3000K	150 lm	>90	~220-230 V, 50/60 Hz	⊖	>0.5	IP20	50000h
10352	10W LED	3000K	150 lm	>90	~220-230 V, 50/60 Hz	⊕	>0.5	IP20	50000h
10348	15W LED	3000K	200 lm	>90	~220-230 V, 50/60 Hz	⊕	>0.5	IP20	50000h
10351	15W LED	3000K	200 lm	>90	~220-230 V, 50/60 Hz	⊖	>0.5	IP20	50000h
10353	15W LED	3000K	200 lm	>90	~220-230 V, 50/60 Hz	⊕	>0.5	IP20	50000h

SATINE CHOCOLATE P025
 SATINE COPPER P024
 SATINE GOLD P023

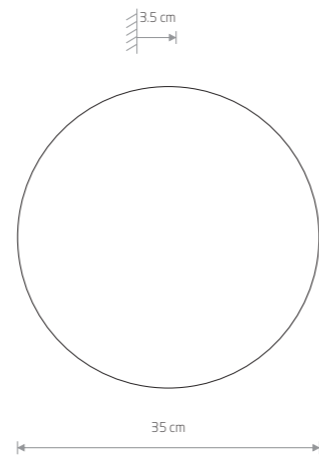

RING WOOD LED L
plywood, painted steel

10282

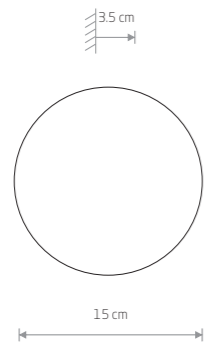

RING WOOD LED S
plywood, painted steel

10280

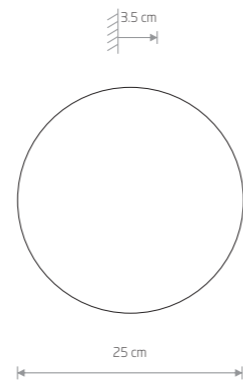

RING WOOD LED M
plywood, painted steel

10281

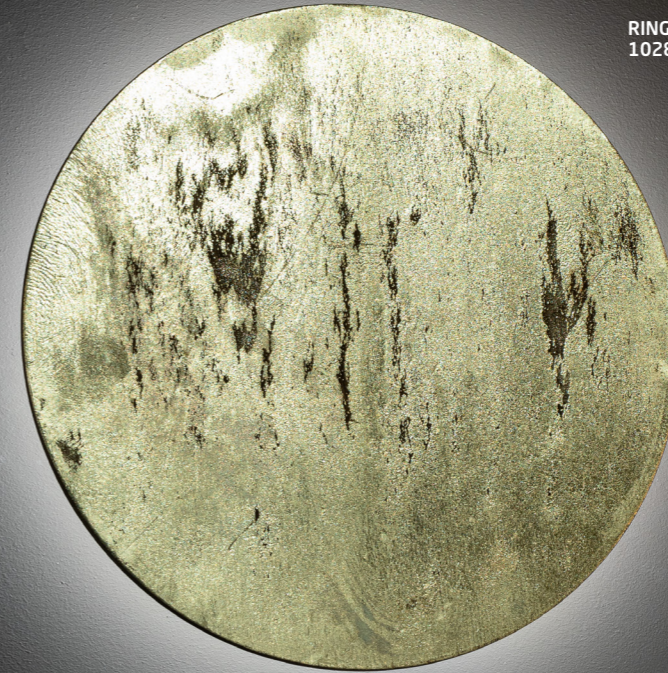

RING WOOD LED M
10281

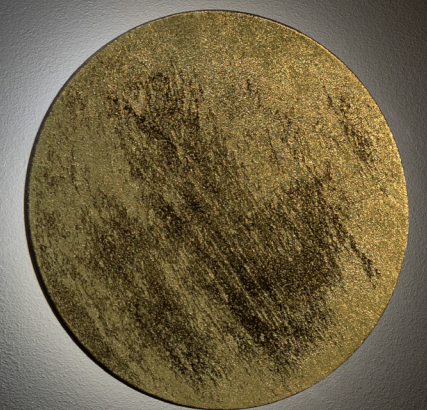

RING WOOD LED S
10280

Item No.	Power	Colour temp.	Luminous flux	Colour Rendering Index (CRI)	Input	Safety type	Power factor	Ingress protection	Lifetime
10280	7W LED	3000K	60 lm	>90	220-230 V, 50/60 Hz	⊕	>0.5	IP20	50000h
10281	10W LED	3000K	150 lm	>90	220-230 V, 50/60 Hz	⊕	>0.5	IP20	50000h
10282	15W LED	3000K	200 lm	>90	220-230 V, 50/60 Hz	⊕	>0.5	IP20	50000h

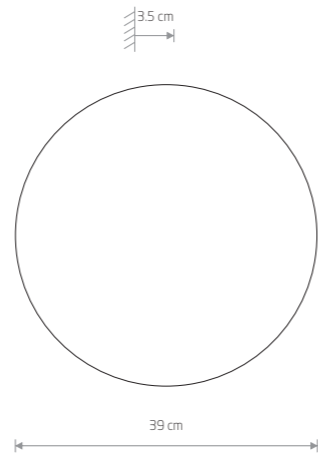

RING MIRROR LED L

glass, painted steel

10278

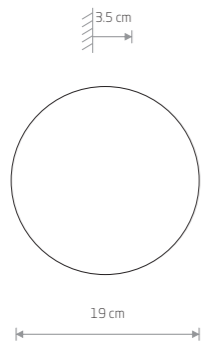

RING MIRROR LED S

glass, painted steel

10276

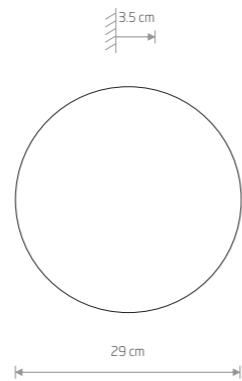

RING MIRROR LED M

glass, painted steel

10277



Item No.	Power	Colour temp.	Luminous flux	Colour Rendering Index (CRI)	Input	Safety type	Power factor	Ingress protection	Lifetime
10276	7W LED	3000K	40 lm	>90	220-230 V, 50/60 Hz	⊕	>0.5	IP20	50000h
10277	9W LED	3000K	90 lm	>90	220-230 V, 50/60 Hz	⊕	>0.5	IP20	50000h
10278	15W LED	3000K	130 lm	>90	220-230 V, 50/60 Hz	⊕	>0.5	IP20	50000h



RING MIRROR LED L
10278



RING MIRROR LED M
10277



PATIO 10105

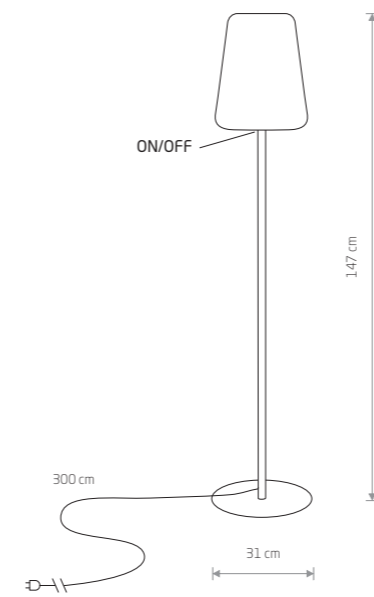

PATIO

■ painted steel, plastic LLDPE

■ 10105

● 1xE27, max 40W





STONE M
10580



STONE L
10581



STONE S
10579



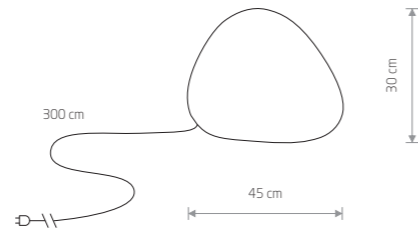

STONE S

plastic PE

10579

1xE27, max 25W

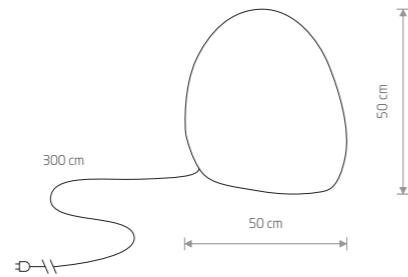

STONE M

plastic PE

10580

1xE27, max 25W

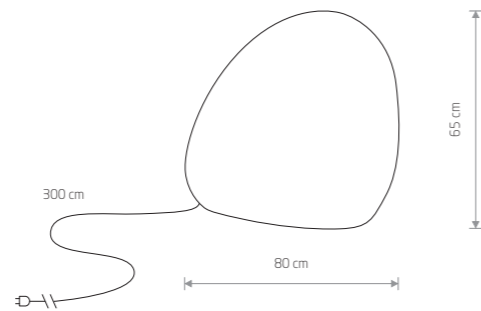

STONE L

plastic PE

10581

1xE27, max 25W



STONE S
10579

STONE L
10581

STONE M
10580

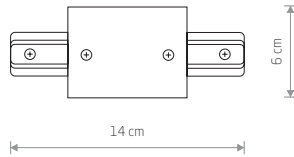

PROFILE RECESSED POWER STRAIGHT CONNECTOR

plastic PC, steel

10227 10228

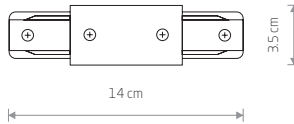

PROFILE POWER STRAIGHT CONNECTOR

plastic PC, steel

10225 10226

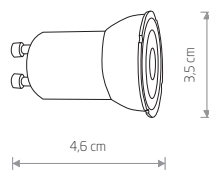

BULB LED GU10 R35, 4W

plastic

10230 3000K 10231 4000K



Item No.	Power	Colour temp.	Luminous flux	Beam angle	Colour Rendering Index (CRI)	Input	Power factor	Lifetime
10230	4W LED	3000K	370 lm	70°	>80	~220-230 V, 50/60 Hz	>0,5	20000h
10231	4W LED	4000K	400 lm	70°	>80	~220-230 V, 50/60 Hz	>0,5	20000h

WHITE BLACK



Nowodvorski
LIGHTING

 Nowodvorski Lighting sp. z o.o.
ul. Bojemskiego 11
42-202 Częstochowa
POLAND

 +48 34 344 91 10 / 11
 nowodvorski@nowodvorski.com
 www.nowodvorski.com





www.nowodvorski.com