



SLAMP®
THE LEADING LIGHT

THE
LANGUAGE
OF LIGHT

COMPENDIUM 2022



THE
LANGUAGE
OF LIGHT



poetic
passionate
fluid
ethical
lively
memorable
powerful
leading
unique
visionary
reliable
handmade

SLAMP:

Light cannot be seen; it manifests, and when abandoned, permeates.

What we perceive is an expression of "The Language of Light".

In this exact moment your eyes are transmitting frequencies and vibrations directly to your nervous system, transforming them into its own reality.

Whether expanding or contracting, the space and matter surrounding us are lighting frequencies; what we perceive as reality, including these words, is nothing more than a multidimensional transmutation of our nervous system.

Within our own internal universe, certain vibrations are transformed into shapes and colors, others in sound, and then there are those that we are not even used to recognize, but that does not mean they do not exist or change us. Knowing or recognizing the language of light involves co-creation through our thoughts, ideas, and emotions; our actions and words lie on the same material level in the world we live in.

Slamp does not simply create illumination to resolve the issue of visualizing a space or an object, instead focusing on igniting the "Internal Light" within us all. And it is exactly that: an internal light that some manifest brightly, others a little less.

We could also call it internal energy, and there are ways to nurture and multiply this energy. A smile, the sensation of joy, or love, or personal harmony, all contribute to positive energy, increasing "Internal Light". This is not something that happens on its own; we need a mirror, a person, an object, or a place that allows us to identify and absorb this light.

Slamp's creations are "torchbearers" for this kind of energy, bestowing unique and positive colors and shapes with devotion, elegance, and love that touches each creation.

Head and heart join with exceptional positive flow (+), harmoniously balancing the negative (-) that we encounter in our everyday world, where immutable rules reign.

Your home, wherever it may be, should cultivate and proliferate this "Internal Light", an almost external tangible force that pushes immense events forward. Just as with happy memories, we collect objects that express and evoke the best things residing in our hearts. We cannot ever be indifferent to the vibrations that beauty, art, design, and harmony transmit. Slamp does exactly this, transmitting this powerful force in every project, visually interpreting the essence of the Language of Light.

La Luce non può essere vista, solo le sue manifestazioni possono essere accolte e, in abbandono, esserne pervasi.

Quello che noi percepiamo è il "Linguaggio della Luce" ovvero la sua espressione.

In questo preciso istante il tuo sistema nervoso, attraverso i tuoi occhi, sta elaborando soggettivamente vibrazioni e frequenze che riconosce, trasformandole nella propria realtà. Che sia in espansione o contrazione, lo spazio e la materia che ci circondano sono frequenze di luce: tutto quello che per noi è realtà, compreso questo testo, non è altro che una trasmutazione multidimensionale del nostro sistema nervoso.

Nel proprio "universo" interiore, alcune vibrazioni vengono trasformate in forme e colori, altre in suono, altre semplicemente non abbiamo l'abitudine di riconoscerle, ma questo non vuol dire che esse non esistano o non ci influenzino. Conoscere o riconoscere il linguaggio della luce vuol dire essere co-creatori attraverso i nostri pensieri, idee ed emozioni - così come lo siamo sul piano materico con azioni e parole - del mondo in cui ci troviamo.

Fare Luce per Slamp non vuole dire solo risolvere il bisogno del vedere un oggetto o uno spazio, bensì riuscire ad accendere la "Luce Interiore" di ognuno. Esattamente, "Luce Interiore". Tutti la possediamo, qualcuno la manifesta con più forza, qualcuno con meno. Se volete, possiamo chiamarla semplicemente energia interiore. Sapete come potete alimentare e moltiplicare questo tipo di energia? Quando sorridete, quando provate gioia, quando amate, quando vi sentite in armonia con l'esterno.

Questo tipo di energia, positiva, accresce il vostro livello di "Luce Interiore". Non pensate di poterla alimentare da soli...serve uno specchio: una persona, magari un oggetto o un luogo, attraverso il quale riconoscerla e assorbirla. Slamp attraverso sue creazioni vuole farsi "tedofora" di questa energia, condividendo le forme, i colori, l'unicità, la positività, la dedizione, l'eleganza, l'amore di cui i nostri prodotti sono fatti.

Tra la mente e il cuore si innesca questo meraviglioso flusso positivo (+) per bilanciare e armonizzare quello negativo (-) che ci arriva dal mondo materico in cui viviamo, le cui regole sono naturalmente impenscindibili. Il luogo in cui vivete, a prescindere da dove si trovi, dovrebbe propagare e nutrire questa "Luce Interiore" che rende capaci di grandi imprese e diventa quasi tangibile anche all'esterno.

Ognuno di noi, proprio come fa con i ricordi felici, colleziona intorno a sé oggetti che esprimono, ri-evocano quanto è più caro al nostro cuore. Essere indifferenti di fronte alle vibrazioni diffuse dalla bellezza, dall'arte, dal design, dalle armonie, è impossibile. Slamp in ogni progetto si fa essenza co-creatrice di questa forza che attraverso i nostri occhi ci insegna, ogni giorno meglio, il linguaggio della Luce.

EDITOR

Roberto Ziliani

CREATIVE DIRECTION

Luca Mazza

MARKETING & COMMUNICATION

Erika Martino

GRAPHIC DESIGN

Noemi Patriarca

PHOTOS

Massimo Listri

Thomas Pagani

Ezio Gosti

Pedro Sadio

Lorenzo Sechi

Fabio Di Carlo

PRE-PRINTED & PRINTED

Printed in November, 2021

Euroteam

The Green Soul Printing



This Catalogue has been printed using plant-based ink.
Questo Catalogo è stampato con inchiostri a base vegetale.



SLAMP S.p.A.

Via Vaccareccia 12/14

00071 - Pomezia, Roma, Italy

tel. +39 06 916 23 91 - fax +39 06 916 23 933

info@slamp.com - www.slamp.com

ALPHABETICAL INDEX

ACCORDÉON	124	HUGO VERTICAL	116
ACCORDÉON VERTICAL	130	IDEA	324
ARIA	24	KALATOS	136
ATLANTE	232	LA BELLE ÉTOILE	172
ATMOSFERA	142	LA LOLLO	166
AURORA	302	LA LOLLONA	162
AVIA	38	LA TRAVIATA	72
AVIA EDITION	42	LA VIE	244
BACH	368	LAFLEUR	328
BIOS	300	LAS PALMAS	380
CACTUS	216	LILLIBET	218
CEREMONY	210	LIZA	236
CHANTAL	60	LUIS	224
CHARLOTTE	46	MEDUSA	234
CLIZIA	146	MIDA	258
CORDOBA	66	MOON	340
DAFNE	304	NUVEM	92
DIAMOND	376	ODEON	264
DRUSA	212	OVERLAY	356
ECSTACITY	500	SUPERMORGANA	214
ÉTOILE	180	THE LIGHTNING ARCHIVES	470
FABULA	208	TULIP	80
FIGURELLA	226	VELI	182
FLORA	204	VENTI	308
GEMMY	238	WOODY	230
GINETTA	222		
GOCCIA	220		
HALF CHARLOTTE	50		
HANAMI	200		
HUGO	120		
HUGO ARCHITECTURAL	106		

SUSPENSION LAMP INDEX



ACCORDÉON
p.124



ACCORDÉON VERTICAL
p.130



ARIA BLACK FADE
p.30



ARIA GOLD
p.24



ARIA TRANSPARENT
p.28



ATLANTE
p.232



ATMOSFERA
p.142



AVIA
p.38



AVIA EDITION
p.42



CACTUS
p.216



CEREMONY
p.210



CHANTAL
p.60



CHARLOTTE GLOBE
p.46



CLIZIA
p.146



CORDOBA
p.66



DRUSA
p.212



ÉTOILE
p.180



FABULA
p.208



FIORELLA
p.226



FLORA
p.204



GEMMY
p.238



GINETTA
p.222



GOCCIA
p.220



HANAMI
p.200



HALF-CHARLOTTE
p.50

SUSPENSION LAMP INDEX



HUGO
p.120



HUGO ARCHITECTURAL
p.106



HUGO VERTICAL
p.116



KALATOS
p.136



LA BELLE ÉTOILE
p.172



LA LOLLO
p.166



LA LOLLONA
p.162



LA TRAVIATA
p.72



LILLIBET
p.218



LIZA
p.236



LUIS
p.224



MEDUSA
p.234



NUVEM
p.92



SUPERMORGANA
p.214



TULIP
p.80



VELI
p.186



VELI FOLIAGE
p.182



VELI MINI
p.188



VELI 7
p.198



WOODY
p.230

CEILING LAMP INDEX



AURORA
p.302



BIOS
p.300



CLIZIA
p.282



DAFNE
p.304



DRUSA
p.296



ÉTOILE
p.294



FABULA
p.298



HANAMI
p.290



KALATOS
p.252



LA BELLE ÉTOILE
p.292



LA VIE
p.244



MIDA
p.258



ODEON
p.264



VELI
p.272

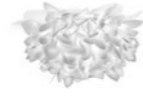

VELI FOLIAGE
p.270



VENTI
p.308

TABLE LAMP INDEX



ACCORDÉON
p.318



ACCORDÉON BATTERY
p.312



ATMOSFERA
p.336



BACH
p.368



BIOS
p.382



CACTUS
p.370



CLIZIA BATTERY
p.342



CLIZIA
p.348



DAFNE
p.384



DIAMOND
p.376



FIGURELLINA
p.364



GEMMY
p.372



IDEA
p.324



LAFLEUR
p.328



LAS PALMAS
p.380



LIZA
p.350



MOON
p.340



OVERLAY
p.356



VELI
p.362



VELI FOLIAGE
p.360



VENTI
p.378

WALL LAMP INDEX



ARIA
p.32



BIOS
p.444



CHARLOTTE
p.54



CLIZIA
p.418



CLIZIA APPLIQUE
p.419



DAFNE
p.446



DRUSA
p.440



ÉTOILE
p.438



FABULA
p.450



FIORELLA MINI
p.448



HANAMI
p.412



IDEA
p.406



LA BELLE ÉTOILE
p.436



LA FLEUR
p.400



LA LOLLO
p.414



LA VIE
p.394



LILLIBET
p.454



MEDUSA
p.452



MIDA
p.388



MIDA APPLIQUE
p.392

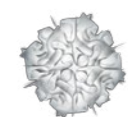

VELI
p.428



VELI FOLIAGE
p.426



VENTI
p.456

FLOOR LAMP INDEX



ATLANTE
p.504



BACH
p.476



BIOS
p.492



CACTUS
p.482



CHARLOTTE
p.56



CLIZIA
p.480



DAFNE
p.494



DIAMOND
p.498



ECSTACITY
p.500



FLORA
p.488



HUGO
p.460



LA LOLLO
p.464



LAS PALMAS
p.496



THE LIGHTNING ARCHIVES
p.470



VENTI
p.502

SLAMP

THE LEADING LIGHT

unveil the unique

Every Slamp lamp is unique. Unique because it does not originate from a 3D file; the creative process requires a designer to get their hands dirty as they cut, "sew", and sculpt materials, applying years of concrete and studious research and development. Unique because the ladies who "tailor light" don their white gloves and proudly bring a poetically original piece to life. Unique because a lamp is the pure expression of the person who selected it, reflecting their aesthetic identity, those who leave light as the only vibration on a silent evening, unwittingly reigniting the energy of an artistic creation with a single click.

Ogni lampada Slamp è unica. Unica perché frutto di un processo creativo che non origina da un file 3d, ma che richiede al progettista la volontà di "sporcarsi le mani", tagliando, cucendo e trattando materiali e valori sedimentati in anni di studio, ricerca e innovazione. Unica perché allestita in un Atelier dove ogni giorno le Sarte della Luce, indossati i loro guanti bianchi, sono orgogliose di mettere al mondo un capo che si distingue per poetica e originalità. Unica perché espressione di chi ama raccontare la propria identità attraverso gli oggetti che lo circondano; di chi lascia che la silenziosa presenza della luce si trasformi nella migliore colonna sonora di una sera; di chi ogni giorno con un click sull'interruttore riaccende, inconsapevolmente, tutta l'energia della creazione.

BEYOND LIGHT

EVERY DAY, WITHIN OUR 8,000 SQ. M ATELIER JUST OUTSIDE OF ROME, WE BRING LIGHT BEYOND THE BOUNDARIES OF WHAT HAS ALREADY BEEN SEEN, BLENDING AESTHETICS AND ETHICS, CHOOSING UNIQUE MATERIALS AND SUSTAINABLE TECHNOLOGIES.

NEL NOSTRO ATELIER MANIFATTURIERO DI 8.000 MQ ALLE PORTE DI ROMA, OGNI GIORNO PORTIAMO LA LUCE OLTRE I CONFINI DEL GIÀ VISTO, FONDENDO ESTETICA ED ETICA, SCEGLIENDO MATERIALI UNICI E TECNOLOGIE SOSTENIBILI.

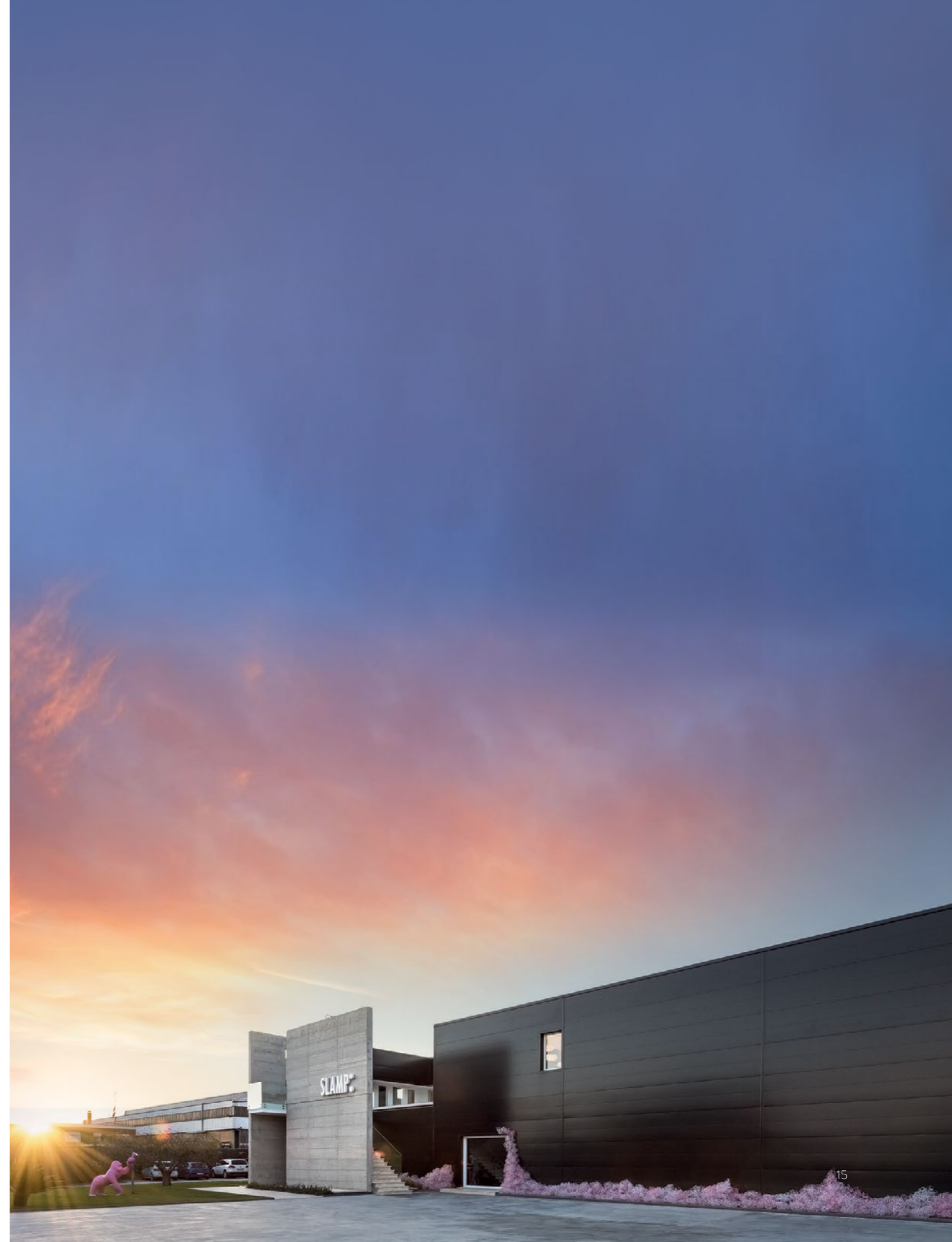

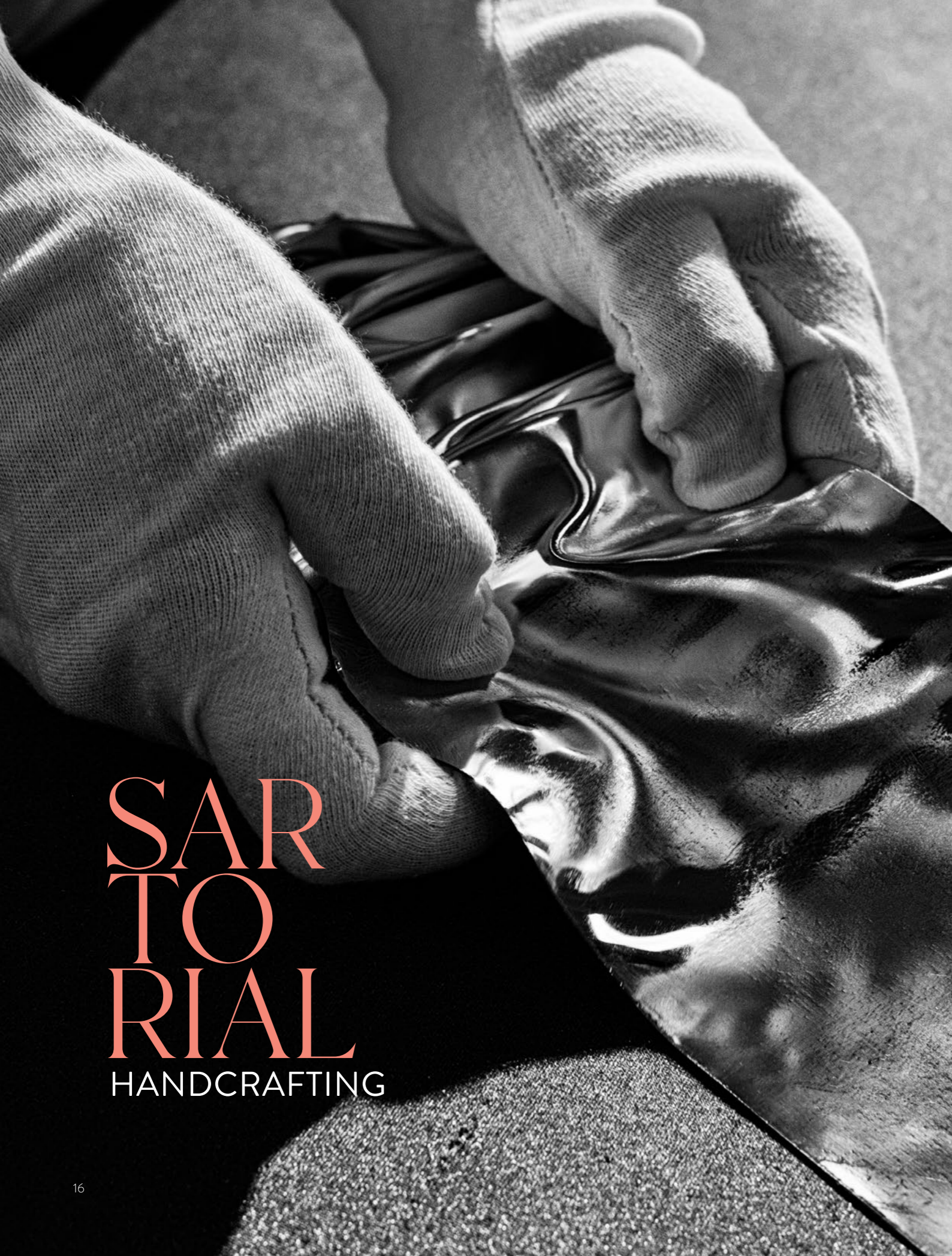

SAR
TO
RIAL
HANDCRAFTING

handmade

in Italy SINCE 1994

Slamp has been at the forefront of creating innovative, original, eclectic, and contemporary lamps since 1994, taking current inspiration from the natural world, architectural and sartorial genius, and artistic trends. Slamp creates suggestive, luminous, and versatile objects using the latest generation of materials, manually moulded into elements that combined together, make up a luxurious landscape. The use of exclusive, lightweight and resistant technopolymers gives a unique and recognizable touch to every lamp, allowing it to be sculpted into three dimensional shapes, decorations and effects that would be impossible using any other material. Much like any maison dedicated to haute couture, Slamp lamps undergo a precise ritual that transforms a sheet of technopolymer material into an exceptionally decorative, three dimensional shape through cold cutting and handcrafting.

Nel panorama dell'illuminazione decorativa di design, Slamp è punto di riferimento per chiunque desideri un oggetto ricercato, originale, esclusivo e innovativo. Catturando gli stimoli più attuali, attingendo al mondo naturale, ai virtuosismi architettonici e sartoriali, alle tendenze artistiche, dal 1994 Slamp crea oggetti luminosi, suggestivi e versatili grazie all'impiego di materiali di nuova generazione e a una speciale abilità manuale nell'assemblare elementi che si compongono dando vita a un lussureggiante panorama figurativo. Unicità e riconoscibilità di ogni lampada passano attraverso l'uso di tecnopolimeri esclusivi, leggeri, nobili e infrangibili che permettono di realizzare forme, decori ed effetti altrimenti impossibili con altri materiali. Come in una maison di haute couture, la creazione di una lampada Slamp passa attraverso una precisa ritualità che trasforma, tramite un sistema di lavorazioni a freddo, incastri e piegature eseguite a mano, un foglio piano di tecnopolimero in un volume tridimensionale altamente decorativo.

from LAMPS TO beehives

SLAMP'S SUSTAINABLE PROJECT

The quality of Slamp's materials and their sustainable approach to working with them has set the company apart since 1994. Their resistant, long-lasting technopolymers not only exhibit optimal thermal, electrical, and chemical properties, but these unique materials are recyclable. The manufacturing processes have a low impact on the environment: the lamps' technopolymer sheets undergo cold cutting before being constructed by hand. The small amount of extra cuttings are recycled monthly, and since the beginning of 2020, a portion of those are being made into beehives for bumblebees by DS-Group. Bumblebees, part of the Apidae family, are widely used in pollinating fruit trees (replacing toxic chemicals). They are used for tomatoes as well, and ensure quality, juicy crops. Slamp applied the same approach to their headquarters, inaugurated September 8, 2019. High priority was placed on architectural decisions, including isolating thermal materials and large windows facing the production lines to reduce the use of artificial light. The hub's energy comes from predominantly renewable sources.

Per le qualità intrinseche dei materiali che impiega, e per le tecniche di lavorazione che utilizza, Slamp è un'azienda a basso impatto ambientale sin dal 1994. I tecnopolimeri, resistenti e durevoli, sono dotati di ottime proprietà termiche, elettriche e chimiche, e – soprattutto – sono riciclabili. I pochi sfridi di lavorazione generati durante la produzione vengono riciclati da sempre ma, dal 2020, parte di essi viene utilizzata anche per la produzione di componenti di arnie per i Bombi. Questa particolare tipologia di imenotteri è fondamentale per la tutela della biodiversità e permette l'impollinazione naturale di piante da frutto e ortaggi in alternativa a prodotti chimici altamente tossici. L'attenzione e la cura dell'ambiente hanno influito anche sull'architettura della sede di Slamp inaugurata nel 2019 alle porte di Roma: parte dell'energia assorbita dall'impianto produttivo arriva da fonti rinnovabili, l'hub produttivo è stato realizzato utilizzando materiali altamente isolanti e gli ampi lucernari sulle linee di allestimento riducono il consumo di luce artificiale.



SUSTAINABLE
PROCESSES

signature collections

TIMELESS WORKS OF ART BORN OF MASTERS OF ARCHITECTURE, CONTEMPORARY GENIUSES LEAVING EXTRAORDINARY CREATIONS TO THE WORLD, EACH A JUBILATION OF LINES, CURVES, SPACES, AND FORMS THAT CELEBRATE THE BEST NATURE HAS TO OFFER.

OPERE D'ARTE SENZA TEMPO, FIGLIE DEI GRANDI MAESTRI DELL'ARCHITETTURA, GENI CONTEMPORANEI CHE LASCIANO IN EREDITÀ A QUESTO MONDO STRAORDINARIE CREAZIONI IN UN TRIPUDIO DI RETTE, CURVE, PIENI E VUOTI, CELEBRANDO I PIÙ PREZIOSI DONI DELLA NATURA.

SLAMP:

ZAHA



From the left: Heydar Aliyev Center, Baku ©Hufton+Crow; Opus Tower, Dubai ©Laurian Ghinitoiu; Heydar Aliyev Center, Baku ©Helene Binet; Maxxi Museum, Rome ©Helene Binet; Maxxi Museum Study Painting.
© All Architectural projects by Zaha Hadid Architects.



Zaha Hadid portrait ©Steve Double

aria GOLD

BY ZAHA HADID

technical details p. 515

SUSPENSION



- 
 SUSPENSION
- 
 WALL LAMP
 p.32
- 
 CEILING LAMP
- 
 TABLE LAMP
- 
 FLOOR LAMP



Aria Gold Medium and Aria Large Transparent



PLAY VIDEO

The Aria Gold has Cristalflex® arms that have been metallised through vapourisation in a hyperbaric chamber, examined for uniformity, then cut using a numerical system before being wrapped in protective film and placed within the box, making customer assembly rapid, intuitive, and enjoyable.

Nella Aria Gold le lance radiali in Cristalflex® vengono prima metallizzate tramite evaporizzazione in camera iperbarica, esaminate per eliminare eventuali scarti, poi tagliate tramite un sistema a controllo numerico e infine inserite nel box, intervallate da uno strato protettivo, al fine di rendere l'installazione da parte del cliente intuitiva, veloce e piacevole.



aria

TRANSPARENT
BY ZAHA HADID

technical details p. 515



Available in 4 dimensions starting from the Small Ø50 cm x h. 75 cm (Ø19-3/4" x h. 29-1/2") to XL version Ø90 cm x h. 130 cm (Ø 35-1/2" x h 51-1/4")

Disponibile in 4 dimensioni a partire dalla Small Ø50 cm x h. 75 cm (Ø19-3/4" x h. 29-1/2") alla versione XL Ø90 cm x h. 130 cm (Ø 35-1/2" x h 51-1/4")



aria

BLACK FADE
BY ZAHA HADID



Aria XL Black Fade
Ø90 x h. 130 cm
(35-1/2" x h. 51-1/4")

-  SUSPENSION
-  WALL LAMP
p.32
-  CEILING LAMP
-  TABLE LAMP
-  FLOOR LAMP



technical details p. 515

SUSPENSION

aria APPLIQUE

BY ZAHA HADID

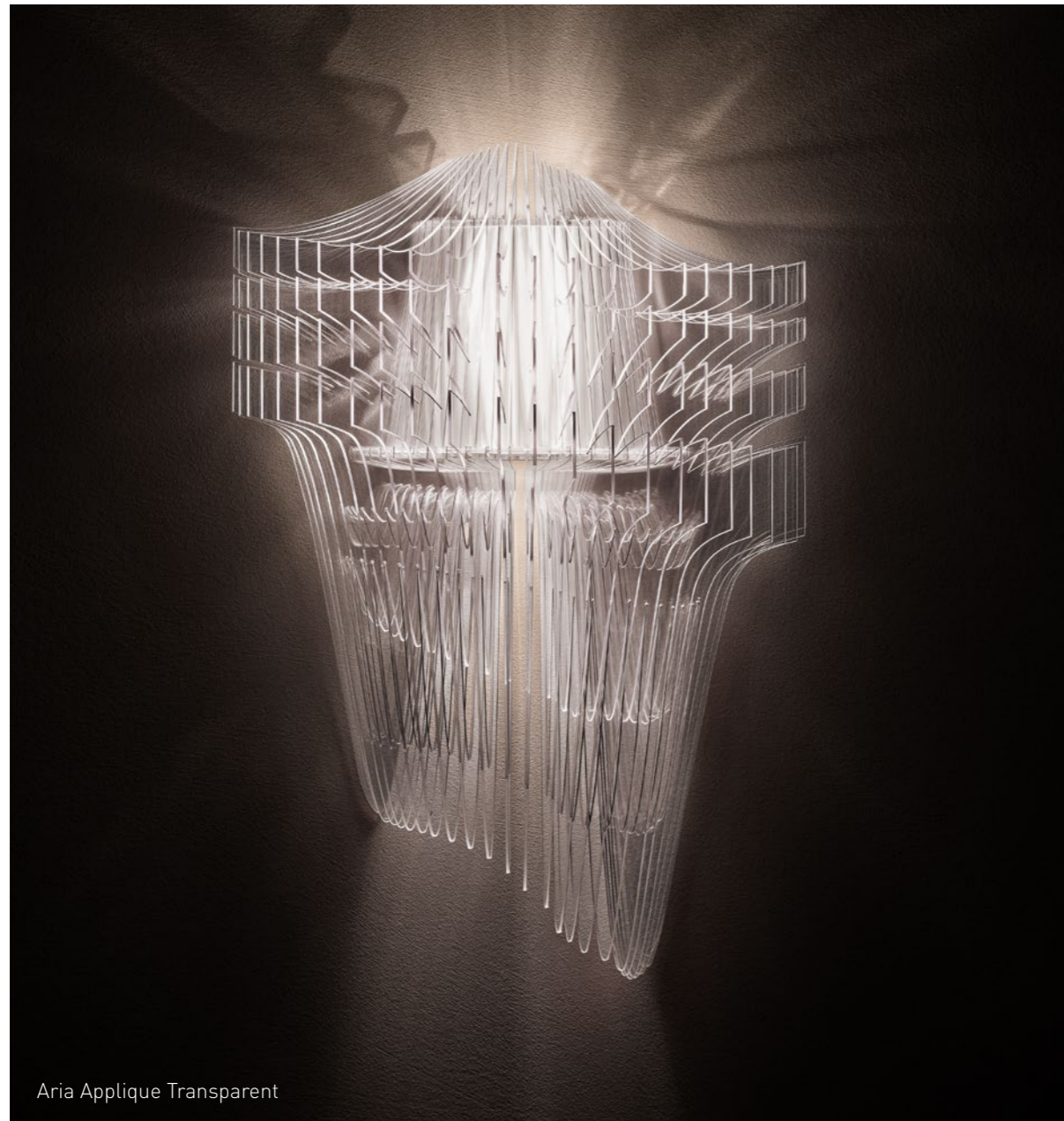

Aria Applique Transparent

-  SUSPENSION
p.24
-  WALL LAMP
-  CEILING LAMP
-  TABLE LAMP
-  FLOOR LAMP

technical details p. 515



ARIA APPLIQUE

WALL LAMP



Aria Gold Applique is made with Cristalflex®, a luxurious technopolymer, metalized through an exclusive aluminum vaporization technique. Highly resistant to elevated temperatures and bending during assembly.

Aria Gold Applique è realizzata con il Cristalflex® tecnopolimero prezioso, metallizzato con un'esclusiva tecnica di vaporizzazione di alluminio. Altamente resistente al calore e alle manipolazioni in fase di assemblaggio.



Lighting / Illuminazione:
2 x 6W E14/E12 LED Filament Bulbs + 1 x 6W Spot LED E14/E12



Size / Dimensioni:
41 x 22 x h. 60 cm - 16" x 8-1/2" x h. 23-1/2"



Aria Applique Gold

VISIONARY NARY LIGHT

avia

BY ZAHA HADID

technical details p. 517-518

SUSPENSION



Avia Large Black Fade



Avia Medium White Fade

Available in 4 dimensions starting from the Small $\varnothing 45 \times h. 85 \text{ cm}$ ($\varnothing 17\text{-}3/4" \times h. 33\text{-}1/2"$) to XL version $\varnothing 75 \times h. 140 \text{ cm}$ ($\varnothing 32\text{-}1/2" \times h. 55"$)

Disponibile in 4 dimensioni dalla Small con $\varnothing 45 \times h. 85 \text{ cm}$ ($\varnothing 17\text{-}3/4" \times h. 33\text{-}1/2"$) alla XL con $\varnothing 75 \times h. 140 \text{ cm}$ ($\varnothing 32\text{-}1/2" \times h. 55"$)



SUSPENSION

WALL LAMP

CEILING LAMP

TABLE LAMP

FLOOR LAMP



Avia Black Fade



Avia White Fade

Zaha Hadid has left an innovative and visionary mark not only on large scale buildings and museums, but on Avia, a suspension fit for intimate settings.

Il visionario e innovativo segno di Zaha Hadid non è più solo appannaggio delle grandi opere architettoniche e degli edifici museali più famosi al mondo: con la collezione Avia esso diventa un privilegio quotidiano per chi la inserisce nella dimensione intima del proprio spazio di vita.

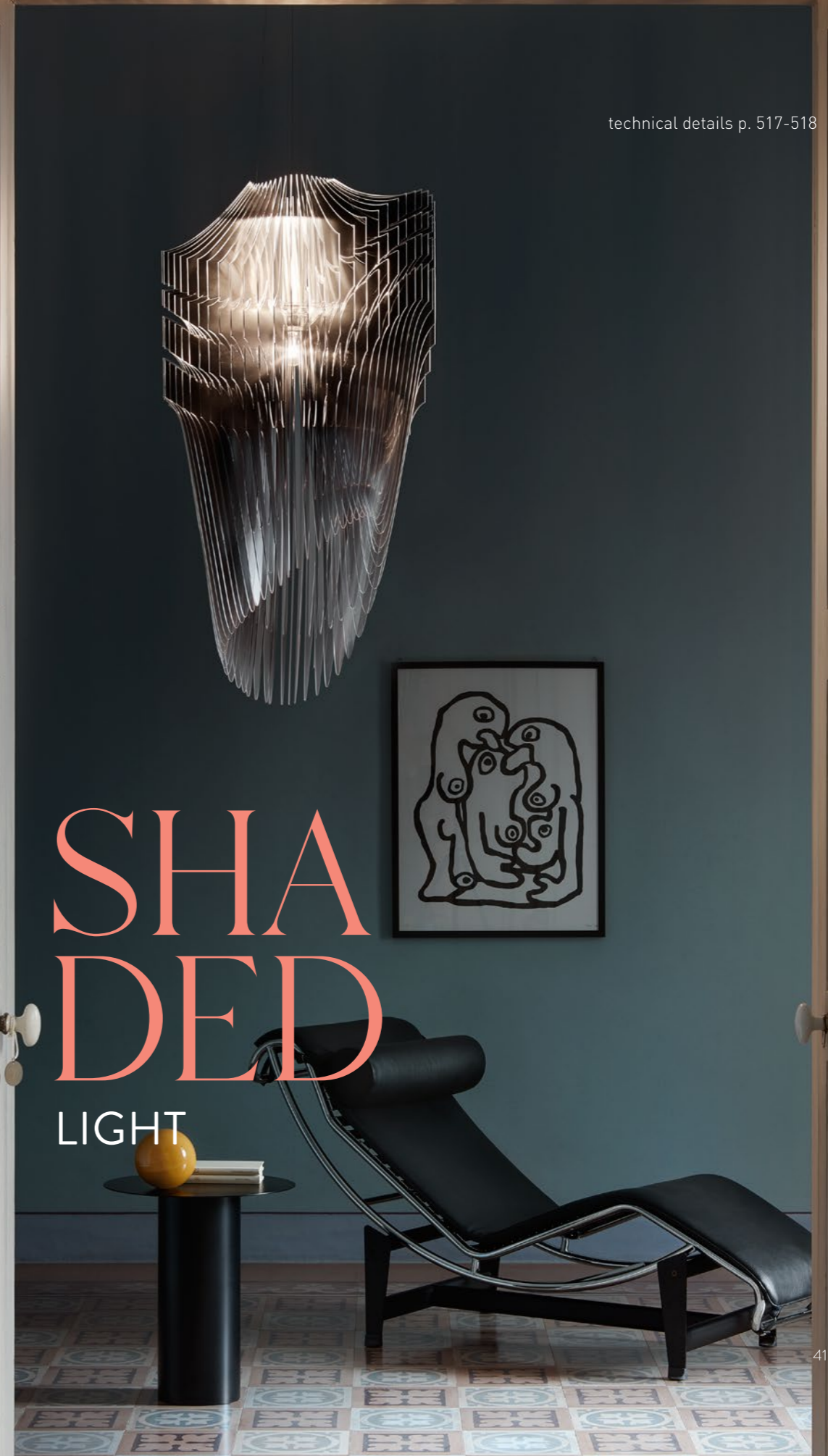

technical details p. 517-518

SHADDED LIGHT

avia EDITION

BY ZAHA HADID

technical details p. 518

SUSPENSION

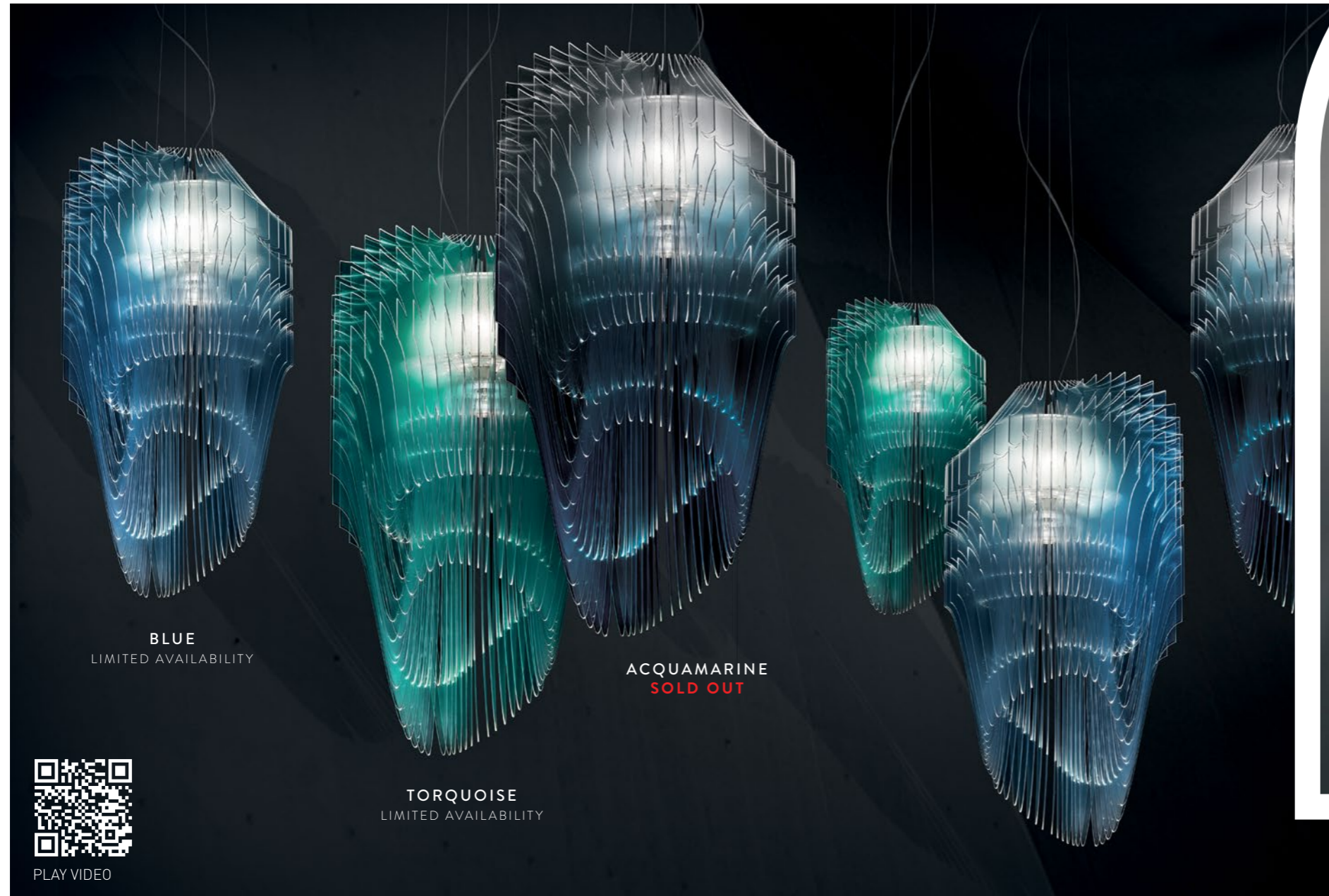

BLUE
LIMITED AVAILABILITY

ACQUAMARINE
SOLD OUT

TORQUOISE
LIMITED AVAILABILITY



PLAY VIDEO



A LIMITED SERIES
OF 99 PIECES
PER COLOUR

Every piece has been authenticated through progressive numbering visible on the lamp and the manufacturing certification.

L' autenticità di ogni singolo pezzo è garantita dal numero progressivo riportato sia sulla lampada che sul certificato di produzione.



SUSPENSION

WALL LAMP

CEILING LAMP

TABLE LAMP

FLOOR LAMP

DORIANA AND MASSIMILIANO



From the left: Guosen Securities Tower, Shenzhen ©Zhang Chao; Learown Fuda Square, Shenzhen ©Studio Fuksas; Duomo Station-Napoli Underground © Roland Halbe; Shenzhen Bao'An International Airport, Shenzhen ©Leonardo Finotti; Zhaoxin Huijin Center, Shenzhen ©Studio Fuksas



Doriana and Massimiliano Fuksas portrait ©Fabio Lovino

charlotte

GLOBE
BY DORIANA AND MASSIMILIANO FUKSAS

technical details p. 523



Charlotte Globe revisits the archetype of the sphere, visiting the impalpable hexagons of a beehive, only one of Studio Funksas' architectural preferences.

Charlotte Globe ricrea - nella forma archetipale della sfera - la trama laboriosa e impalpabile del nido d'ape, segno distintivo degli architetti Funksas.

- 
 SUSPENSION
- 
 WALL LAMP
 p.54
- 
 CEILING LAMP
- 
 TABLE LAMP
- 
 FLOOR LAMP
 p.56



The external layer of Cristalflex® encloses a luminous internal layer of Lentiflex®, that emits a uniform glow. Includes 4 light sources and a magnetic hanging system that makes installation and maintenance simple.

Realizzata in Cristalflex® – con una struttura interna in Lentiflex® che contribuisce alla diffusione omogenea della luce- Charlotte Globe è dotata di 4 fonti luminose e di attacco magnetico per una facile installazione e manutenzione.



half charlotte

BY DORIANA AND MASSIMILIANO FUKSAS

technical details p. 523

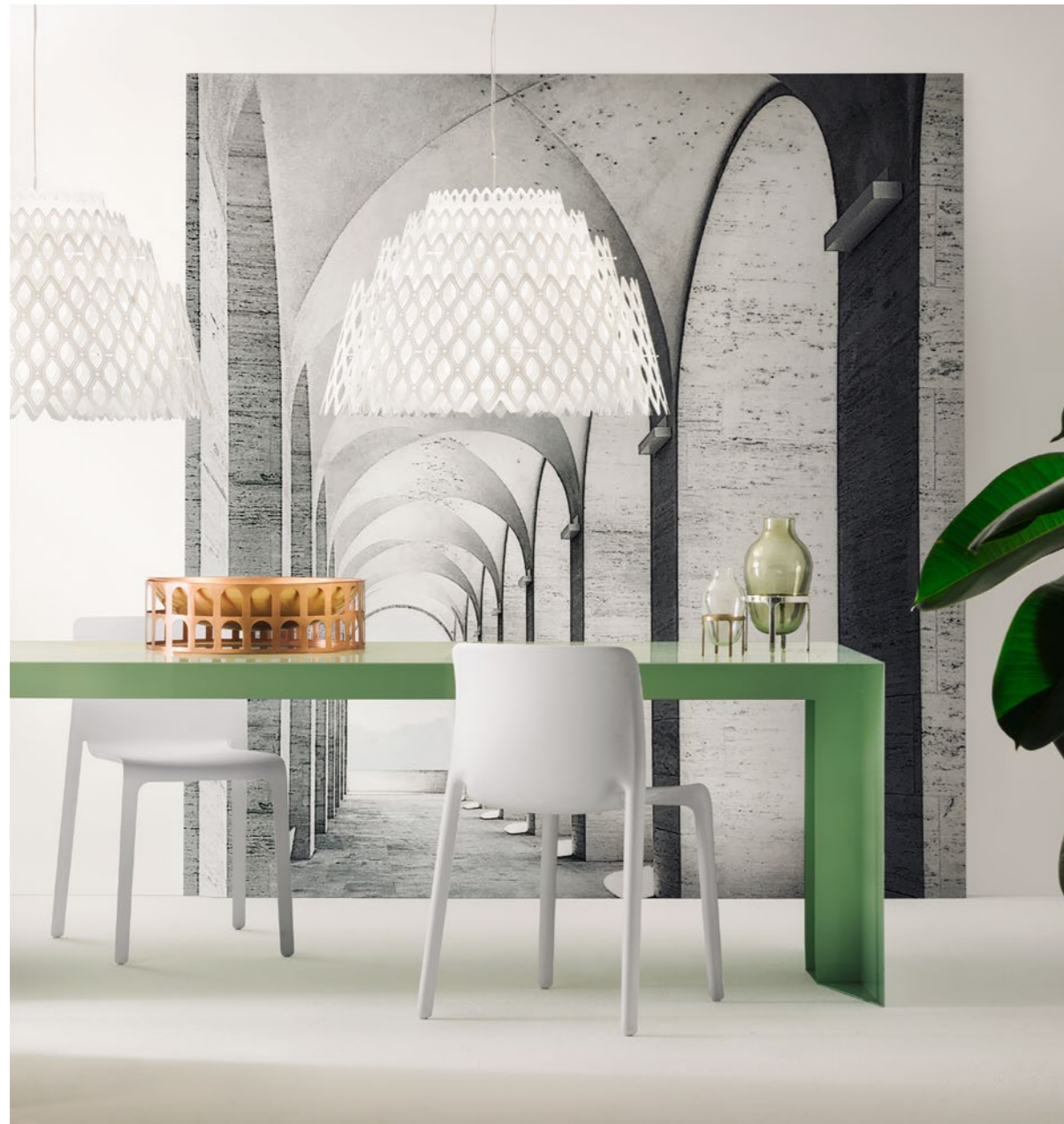

Size / Dimensioni:
Ø79 cm x h. 55 cm
(Ø31-1/4" x h. 21-1/2")

Lighting / Illuminazione:
4 x 12W E27/E26 LED
Filament Bulbs

SUSPENSION
p.46

WALL LAMP
p.54



CEILING LAMP

TABLE LAMP

FLOOR LAMP
p.56

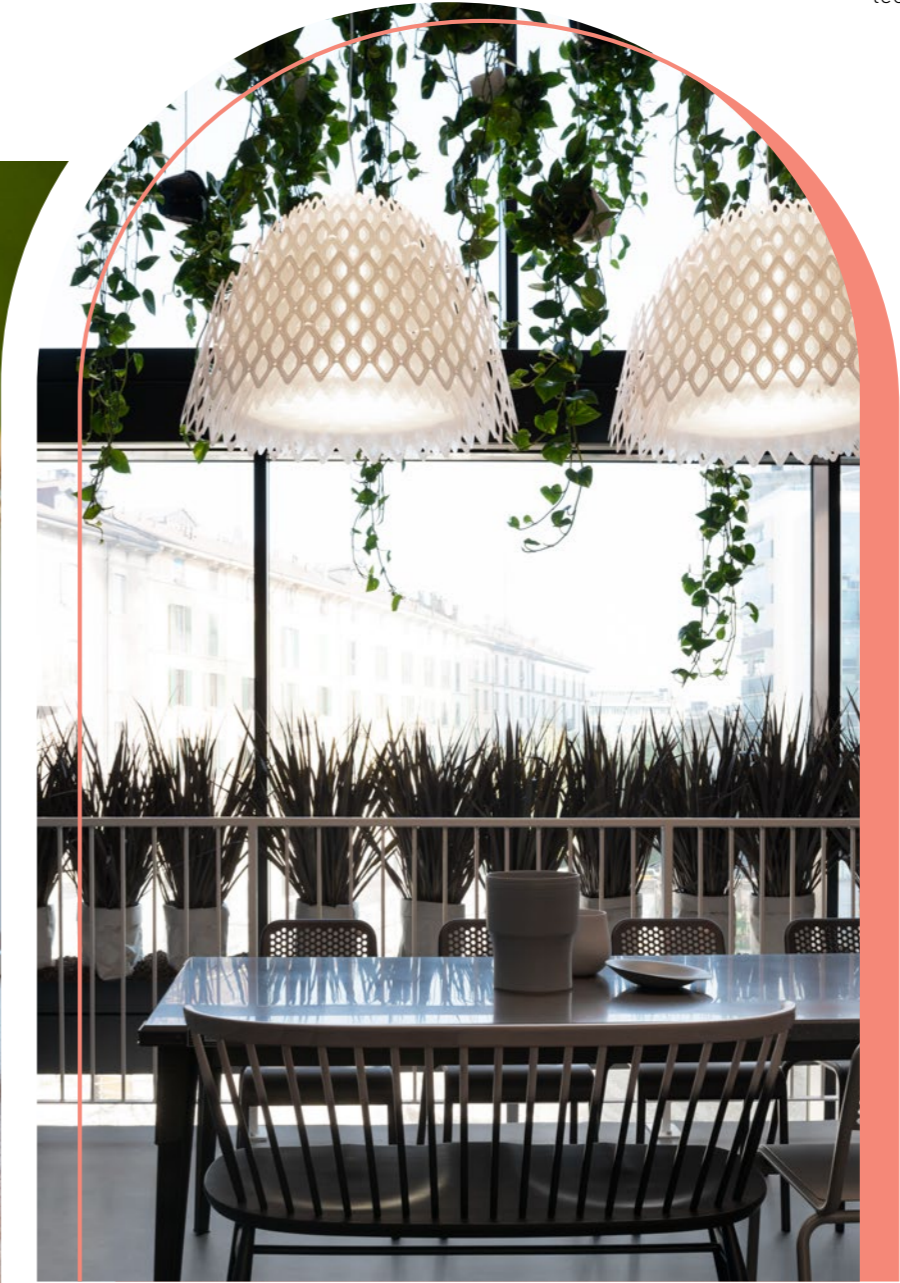

© Is Molas Resort, Sardinia, Italy.



PLAY VIDEO

charlotte

BY DORIANA AND MASSIMILIANO FUKSAS



Size / Dimensione:
21 x 12,5 x h.32 cm
8-1/4" x 5" x h. 12 1/2".

Lighting / Illuminazione:
1 x 12W E27/E26 LED Filament bulb



SUSPENSION
p.46



WALL LAMP



CEILING LAMP



TABLE LAMP

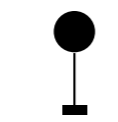

FLOOR LAMP
p.56



technical details p. 524

SCULPTURAL
SHAPE

WALL LAMP

charlotte

BY DORIANA AND MASSIMILIANO FUKSAS



Size / Dimensioni:
Ø32 x h.182 cm
Ø12-1/2" x h. 71-3/4"

SUSPENSION
p.46

WALL LAMP
p.54

CEILING LAMP

TABLE LAMP

FLOOR LAMP

MUCH LIKE HONEY COMB

Lighting / Illuminazione:
2 x 12W LED Dimmable
Filament bulbs (dimmer included)





Charlotte's sculptural shape seems to be molded from a singular, industrious frame, much like honeycomb with its impalpable elements

Charlotte, in tutte le sue multiformi declinazioni, sembra modellarsi da un unico volume con una trama laboriosa, a tratti impalpabile, come quella del nido d'ape



chantal

BY DORIANA AND MASSIMILIANO FUKSAS



Lighting / Illuminazione:
M: 7 x 12W E27/E26 LED Filament Bulbs
S: 4 x 12W E27/E26 LED Filament Bulbs

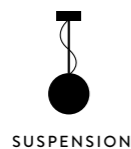

SUSPENSION



WALL LAMP



CEILING LAMP



TABLE LAMP



FLOOR LAMP



SCULP
TURAL
SHAPE

technical details p. 523



Chantal Orange

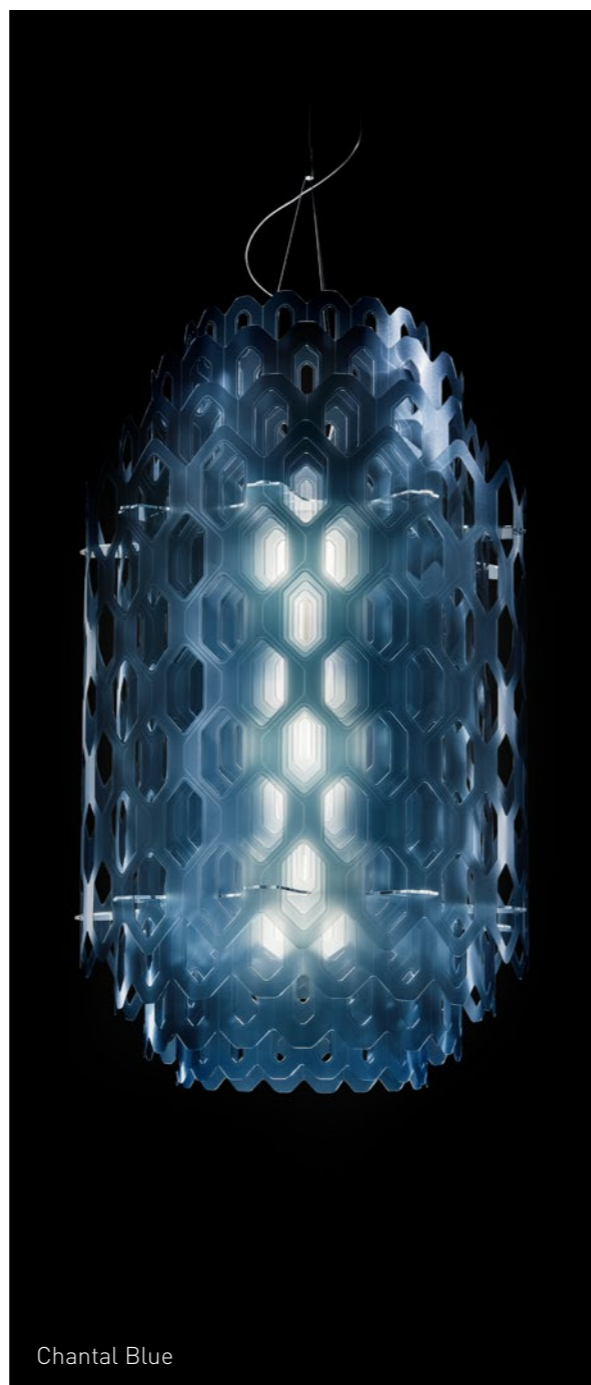

Chantal Blue

Chantal's sculptural shape seems to be molded from a singular, industrious frame, much like honeycomb.
La forma scultorea di Chantal sembra modellarsi da un unico volume, con una trama laboriosa a tratti impalpabile, come quella del nido d'ape.



technical details p. 523

DANIEL



From the left: World Trade Center, NY ©Hufton+Crow; World Trade Center, NY ©Hufton+Crow; Vanke Pavillion, Expo 2015 ©Hufton+Crow; Dresden Museum of Military History ©Hufton+Crow; Studio Weil, Mallorca ©Bitter Bredt; Zhang Zhidong Museum, Wuhan ©Hufton+Crow; World Trade Center, NY ©Hufton+Crow; National Holocaust Monument, Ottawa ©DoubleSpace; The Wohl Centre, Bar-Ilan University , Aerial View of North Elevation ©BitterBredt.



Daniel Libeskind portrait ©Stefan Ruiz

cordoba

BY DANIEL LIBESKIND

technical details p. 526



A DECONSTRUCTIVIST
LAMP WITH
A CULTURAL TWIST

Lighting/Illuminazione:
130W 110-240 Vac/24 Vdc - 15.000 Lumen - 2900 Kelvin

Size/Dimensione:
76 x 104 x h.55 cm - 30" x 41" x h. 21"

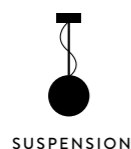

SUSPENSION



WALL LAMP



CEILING LAMP



TABLE LAMP



FLOOR LAMP



A mathematical algorithm combines two dimensional technopolymer sheets into a suspension that harmoniously glows. Cordoba is handcrafted, offering endless angles from every viewpoint.

Lastre bidimensionali di tecnopolimeri prendono vita da un algoritmo matematico e diffondono la luce in maniera armonica. Cordoba è allestita completamente a mano, offrendo diversi punti di vista a chi la osserva nella sua interezza.



ROBERT



From the left: Macbeth, São Paulo, Teatro Municipal ©Roger H. Sassaki ; Odyssey, Athens ©Evi Fylaktou; Slamp La Traviata Light Sculpture ©Lorenzo Sechi; The Old Woman scene 6 The Bakery, William Dafoe ©Lucie Jansch; Adam's Passion, by Arvo Pärt and RW, in the photo Michalis Theophanous, Tallinn, Estonia; La Traviata, directed by Robert Wilson. Act 1, Myung Joo Lee (Violetta Valéry) Linz, 2015 ©Lucie Jansch.



Robert Wilson portrait ©Lucie Jansch

la traviata

BY ROBERT WILSON

technical details p. 538

SUSPENSION

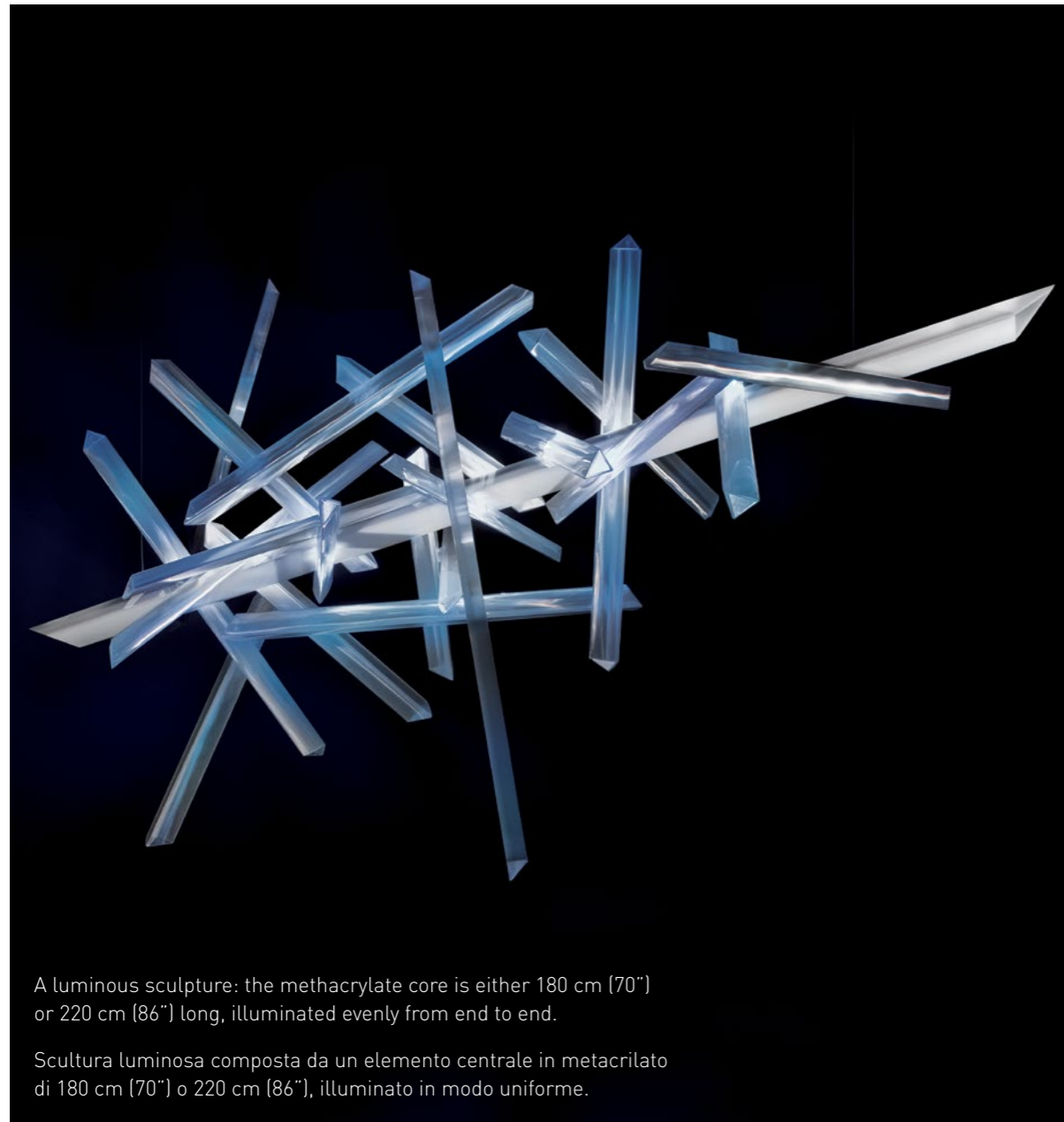

A luminous sculpture: the methacrylate core is either 180 cm (70") or 220 cm (86") long, illuminated evenly from end to end.

Scultura luminosa composta da un elemento centrale in metacrilato di 180 cm (70") o 220 cm (86"), illuminato in modo uniforme.



SUSPENSION



WALL LAMP



CEILING LAMP

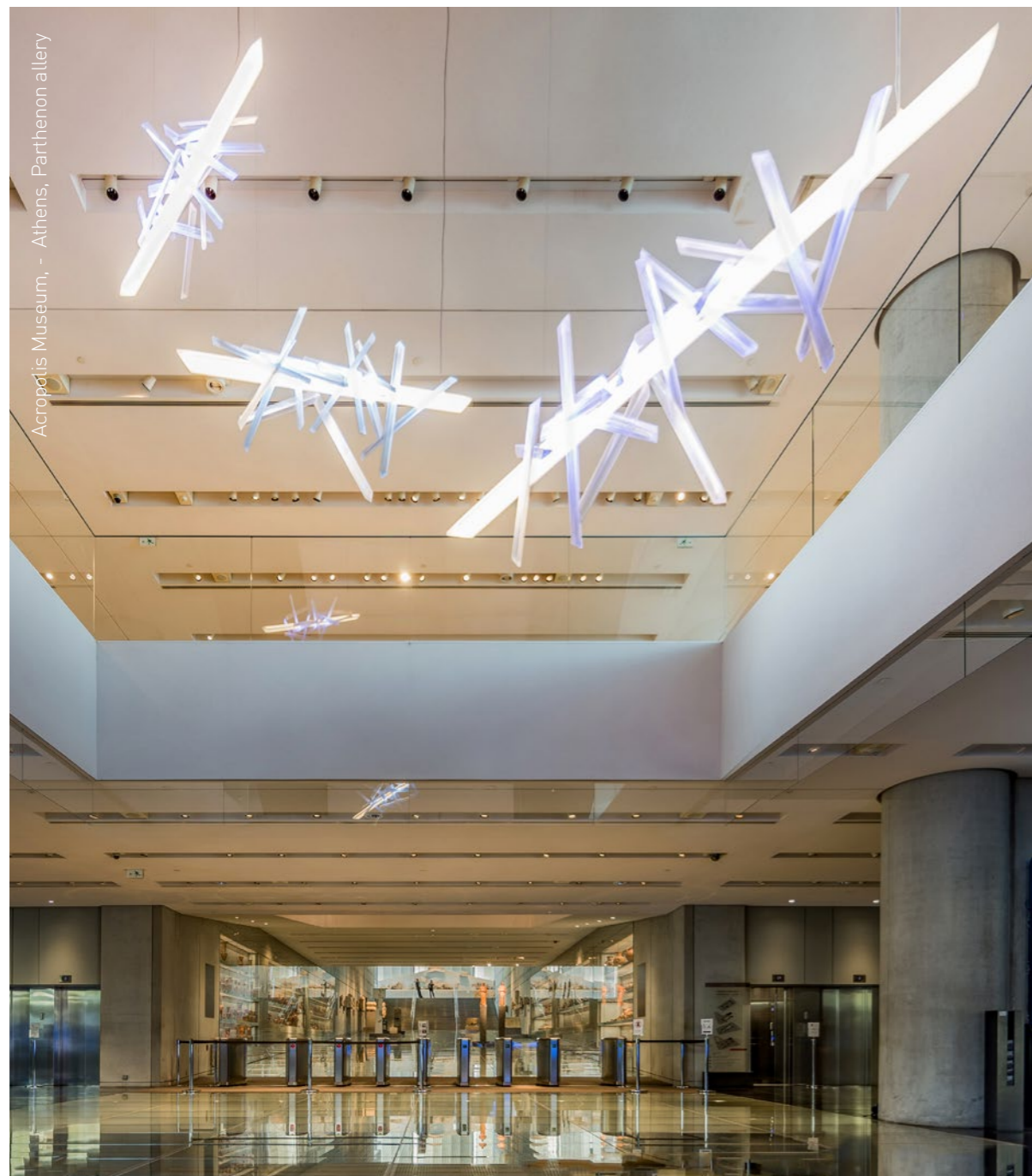

TABLE LAMP



FLOOR LAMP

"WITHOUT LIGHT
+ THERE IS
NO SPACE"
robert wilson



Acropolis Museum, - Athens, Parthenon allery

La Traviata is a complete work of art, blending architecture, light, poetry, dance, and movement. Producer Robert Wilson transferred his own dialogue between theatre and design to a luminous sculpture; the colours and intensity can be changed with a control system.

La Traviata è un'opera d'arte totale: è architettura, è luce, è poesia, è danza, è movimento. Con un dialogo tra design e teatro, il drammaturgo Robert Wilson ha trasferito il suo linguaggio in una scultura luminosa con un sistema di comando a distanza per gestire colori e intensità luminosa.



Installation within the Cantina Felsina, Tuscany.
Installazione presso la Cantina Felsina (Toscana).



PLAY VIDEO

modular collections

WHEN A SINGLE PRODUCT IS NOT ENOUGH, WHEN THE DESIRE COMES TO MOVE BEYOND THE CONFINES OF A DESIGN, TO CO-CREATE AN EVEN BRIGHTER, LARGER LIGHT THAT FITS IN LINE WITH THE SPACE, SETTING A MORE INCISIVE SCENE.

QUANDO UN PRODOTTO FINITO NON BASTA, QUANDO IL DESIDERIO È DI VALICARE I CONFINI DEL PROGETTO, DI ESSERE CO-CREATORI DI UNA LUCE PIÙ BRILLANTE, PIÙ GRANDE, PIÙ IN LINEA CON I PROPOSITI ALLESTITIVI, E LASCIARE UN SEGNO ANCOR PIÙ INCISIVO SULLA SCENA.

SLAMP:

marc
sadler

“LIGHT IS MAGIC
AND FUNCTION UNITED”

SLAMP:



tulip

BY MARC SADLER



Tulip 7 Round

-  SUSPENSION
-  WALL LAMP
-  CEILING LAMP
-  TABLE LAMP
-  FLOOR LAMP



technical details p. 544



Pictured: a free-standing composition of 21 blooms.
Nella foto una composizione free-standing con 21 boccioli.

Lighting / Illuminazione:
Tulip 7: 7 x 5W G4 LED Dimmable Bulbs- 3500 Lumen - 2900 Kelvin
Tulip 14 + Tulip Free-standing: 14 x 5W G4 LED Dimmable Bulbs
7000 Lumen - 2900 Kelvin

TULIP ROUND CANOPY



The 50cm/ 19-1/2" brushed brass canopy holds from 7 to 14 handcrafted blooms. Just like the Linear Canopy, the cascade is in a predetermined composition by the Designer in a Plug & Play solution. The blooms hang from the ceiling rose on thin steel cables, and their height can be adjusted during installation to fit the space.

Il rosone in ottone spazzolato di 50 cm di diametro ospita 7 o 14 fiori realizzati a mano. Come nella versione Linear Canopy, anche in questa la disposizione dei Tulipani nella cascata di luce è predeterminata dal Designer per una soluzione allestitiva Plug & Play. L'altezza dei fiori, fissati al rosone con sottili cavi d'acciaio, è gestibile in fase di installazione per assecondare lo stile e la necessità dell'ambiente in cui è inserito.

TULIP LINEAR CANOPY



The Tulip modular system has rectangular blooms and a Plug & Play system. Seven to fourteen Tulips hang from the brushed brass canopy (from 70 cm / 27-1/4" to 110 cm / 43") depending on the number of blooms) on thin steel cables positioned in an almost weightless, harmonious predetermined composition by the Designer. Just need to anchor the bracket to the ceiling and then install the Tulip cluster so to create a sinusoid of flowers that can be adjusted in height at will.

Nella versione con rosone rettangolare, il sistema modulare Tulip è proposto in una composizione Plug & Play. 7 o 14 Tulipani discendono dalla coppetta in ottone spazzolato (di 70 o 110 cm in base al numero di fiori) tramite dei sottili cavi di acciaio posizionati dal Designer in una composizione predeterminata, armonica e leggera. Sarà sufficiente ancorare la staffetta al soffitto e poi sollevare il cluster di Tulip creando una sinusoide di fiori ad altezze variabili secondo il proprio gusto.

TULIP FREE-STANDING



Multiples of 14 are available to create dramatic installations anchored to the ceiling with small brushed brass fixtures that can be placed where desired. To help with installation, Slamp includes two illustrations of how the 14 blooms can be placed. This system allows for more aesthetic and technical control than the ceiling rose solutions, including connection to a single electrical source and the creation of a multi-point lighting chain using thinly braided copper wires.

Disponibile in multipli di 14 per creare scenografiche installazioni, questa edizione può essere ancorata al soffitto tramite piccoli fissaggi in ottone spazzolato posizionabili alla distanza desiderata. Per facilitare l'installazione, Slamp fornisce due dime con il disegno dei 14 fori. Questa soluzione lascia libertà compositiva pur mantenendo le stesse caratteristiche estetiche e tecniche delle soluzioni con rosone, come la connessione a un unico attacco elettrico e il concatenamento dei vari punti luce tramite il sottile cavo di rame intrecciato.

REPLACEABLE G4 LIGHTBULBS

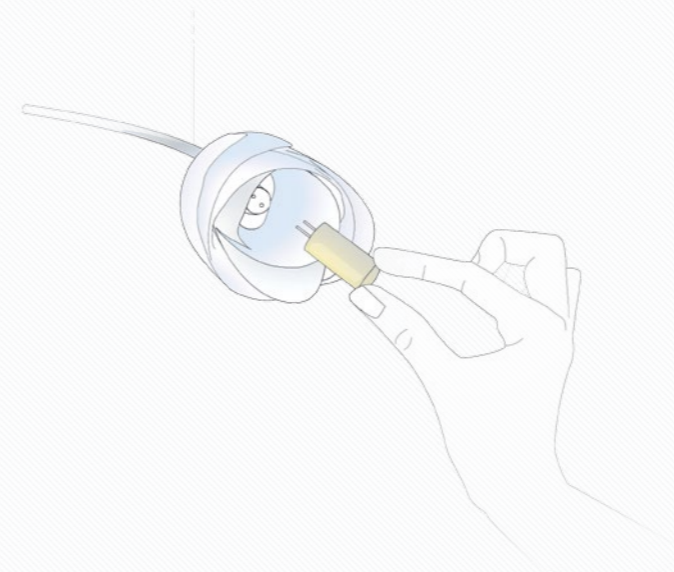

The LED G4 2900 Kelvin lightbulbs come with the product and can be replaced autonomously, a dual-function commodity that allows for more efficient and rapid maintenance, as well as the personal choice of warmer or cooler lighting.

Le lampadine a LED G4 2900 Kelvin sono fornite insieme al prodotto e possono essere sostituite autonomamente. Una piacevole comodità per assolvere due funzioni: rendere le operazioni di manutenzione più rapide ed efficienti, assecondare i gusti di chi preferisce una luce più calda o più fredda.



This page: a free-standing composition of 80 blooms.
Previous page: a view from below the composition.

In questa pagina una composizione free-standing con 80 boccioli, nella pagina precedente una vista dal basso della stessa.



Slamp's exclusive, unbreakable Lentiflex® technopolymer is manually sculpted at a controlled temperature to create an illuminated bloom.

La modellazione manuale a temperatura controllata del Lentiflex®, tecnopolimero infrangibile di Slamp, dà vita ai boccioli luminosi di Tulip.



HAND MOLDED TULIPS

miguel arruda

“NUVEM IS NOT A LAMP,
BUT A GLOWING CEILING”

SLAMP:



nuvem

BY MIGUEL ARRUDA

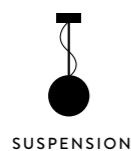

SUSPENSION



WALL LAMP



CEILING LAMP



TABLE LAMP



FLOOR LAMP



technical details p. 542

Single module size /Dimensioni modulo singolo:
102 x 94 x h. 6 cm - 39-3/4 x 36-1/2 x h 2-1/4".

Modules of 1 sq. meter can be joined in infinite combinations; bidirectional illumination.
Moduli da 1 mq con luce bidirezionale componibili all'infinito.



"We didn't create a lamp, we created a ceiling." Architect Miguel Arruda created a system of 1 m hexagonal components that can be combined infinitely in diverse luminous installations.

"Non abbiamo fatto una lampada, abbiamo fatto un soffitto". Con queste parole l'Arch. Miguel Arruda introduce Nuvem: un sistema componibile di moduli da 1 mq ciascuno (di sezione esagonale) che si può comporre all'infinito creando differenti scenari luminosi.



technical details p. 542



Nuvm Velvet is made of silky, iridescent and printed Lentiflex®, joined by a bi-directional spotlight.
 Nella versione Velvet la Nuvm è realizzata in Lentiflex® stampato che rende il modulo iridescente e setoso, coordinato anche il faretto spot bidirezionale.



PLAY VIDEO

Composition with 14 White modules and 7 bidirectional spotlights in a private house, Apulia, Italy.
 Composizione con 14 moduli White e 7 spotlight bidirezionali, Villa privata in Puglia.

INFINITE EXTENSIONS IN EVERY DIRECTION

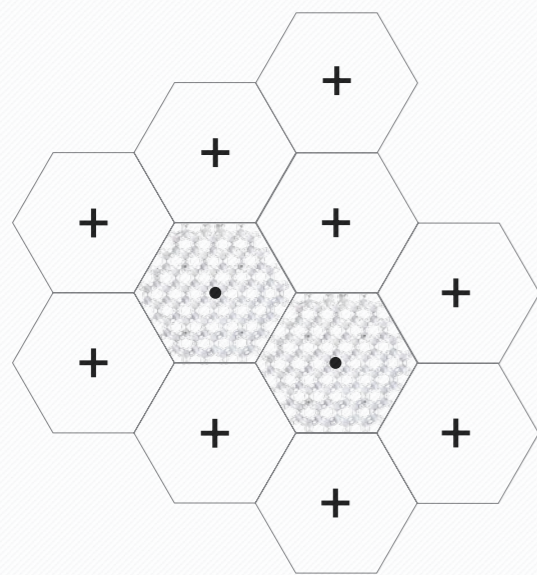

The meter-long hexagonal elements are easily connected by hand using a series of interlocking tabs that allow for limitless omnidirectional installation. The modules facilitate the adaptable and mutable personalization of private and contract spaces, adding a strong artistic note to each..

Gli elementi esagonali di un metro quadro, tramite un semplicissimo sistema di connessioni eseguibili a mano, si uniscono gli uni agli altri espandendosi in ogni direzione, per personalizzare gli ambienti con design sempre diversi e aggiungere una forte connotazione artistica ad abitazioni private e strutture ricettive.

PERSONALIZED SPOTLIGHTS

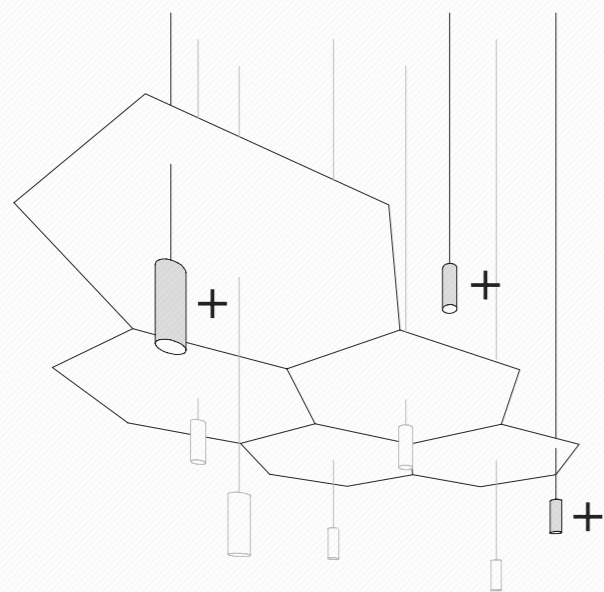

Nuvm's lighting system is a series of bidirectional spotlights (one per square meter) that can be positioned above or below (threaded through the modules' openings). Additional spotlights can be purchased separately for compositions that require amplified illumination.

Il sistema luminoso di Nuvm è composto da una serie di faretti con emissione bidirezionale (uno per ogni mq) che possono essere calati al di sotto del modulo decorativo, passando tramite i fori della composizione, o sollevato al di sopra della struttura. In presenza di particolari necessità compositive, eventuali faretti aggiuntivi possono essere acquistati separatamente.

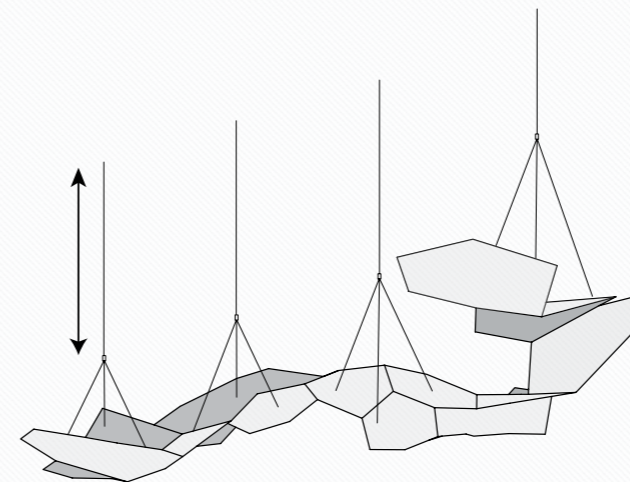

ADJUSTABLE HEIGHT

Nuvm's height can be adjusted using the 6 meter cable, and once suspended, the design can be "moulded" using the push and pull system located directly beneath each module. The lamp collapses or tenses when the wires are pushed (released) or pulled, giving the ceiling a fluctuating feeling.

Oltre alla regolazione dei cavi fino a 6 metri, Nuvm dà la possibilità di modulare il design dell'oggetto, una volta sospeso, tramite il sistema "push and pull" posto direttamente al di sotto del modulo decorativo. Tirando o rilasciando i singoli cavi, la lampada si anima – collassando o stirandosi – per dare forma a un "soffitto" fluttuante.



FROM A LAMP TO A VERTICAL DECORATION

Weightless and free...just like a cloud. Nuvm goes beyond traditional illumination, with agile anatomy that allows it to transform the architectural elements of a space, running across the ceiling and moving down the walls, creating an infinite sky.

Leggera e libera come una nuvola, Nuvm va oltre la semplice illuminazione tradizionale: l'agilità della sua anatomia le permette di enfatizzare gli elementi architettonici trasformandosi da "soffitto" a decoro, calando sulle pareti per eliminare ogni confine tra cielo e terra della stanza



The 1 sqm modules have been handcrafted, really tailored, by Slamp's artisans; each can be connected thanks to a quick, intuitive, easy to install system that uses simple tabs.

I moduli da 1 mq sono pre-allestiti a mano dalle Sarte della Luce di Slamp e si possono collegare l'uno all'altro tramite dei semplici bottoni, rendendo l'installazione rapida e intuitiva.





This page: composition with 12 White modules and 5 bidirectional spotlights, Restaurant in Milan, Italy.
 Previous page: Nuvem illuminate the ADI Design Museum Compasso d'Oro, Milan, Italy.

In questa pagina: una composizione con 12 moduli in versione white e 5 faretti bidirezionali in un ristorante a Milano. Nella pagina precedente: Nuvem illumina l'ADI Design Museum Compasso d'Oro a Milano.



Installation in Vila Franca de Xira Municipal Library, Portugal.
 Installazione presso la Biblioteca Municipale di Vila Franca de Xira in Portogallo.

ONE SQM MODULES



Nuvem Velvet

hugo ARCHITECTURAL SYSTEM

BY SLAMP CREATIVE DEPARTMENT

technical details p. 534



The Hugo Architectural System supports up to 7, one meter modules on a single electric input.
 Il sistema Hugo Architectural permette di connettere fino a 7 lampade da 1 metro con un solo attacco elettrico.

- 
 SUSPENSION
- 
 WALL LAMP
- 
 CEILING LAMP
- 
 TABLE LAMP
- 
 FLOOR LAMP
 p.460

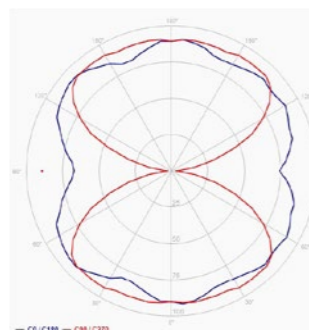

PHOTOMETRIC DIAGRAM, HUGO.
DIAGRAMMA FOTOMETRICO DELLA HUGO.

COMPLIANT WITH THE UNI EN 12464-1:2011 STANDARD

Hugo offers the same qualities of traditional technical lighting without losing Stamp's iconic aesthetic value. The main office requirements established in the UNI EN 12464-1:2011 require an average illumination of 500 lx on work surfaces, a uniformity coefficient U0 greater than 0.6, and a glare value (UGR) of less than 19. Both the Prisma and White versions conform to these requirements, including a CRI (colour rendering index) greater than 90.

Hugo offre una qualità di luce paritetica a quella degli apparecchi per illuminazione tecnica, in aggiunta al valore estetico tipico dei prodotti Stamp. I principali requisiti illuminotecnici per gli uffici, così come stabiliti all'interno della norma UNI EN 12464-1:2011 prevedono un livello di illuminamento medio sul piano di lavoro pari a 500 lx, un coefficiente di uniformità U0 maggiore di 0,6 e un valore di abbagliamento (UGR) minore di 19. I calcoli illuminotecnici eseguiti sia con la fotometria della versione Prisma che della White dimostrano la completa rispondenza dei progetti ai parametri richiesti, incluso l'indice di Resa Cromatica (CRI) > 90.





Hugo Architectural System 2



LIGHTING
 SYSTEM

Installation of 50 modules.
 Installazione di 50 moduli.

MAXIMUM FLEXIBILITY

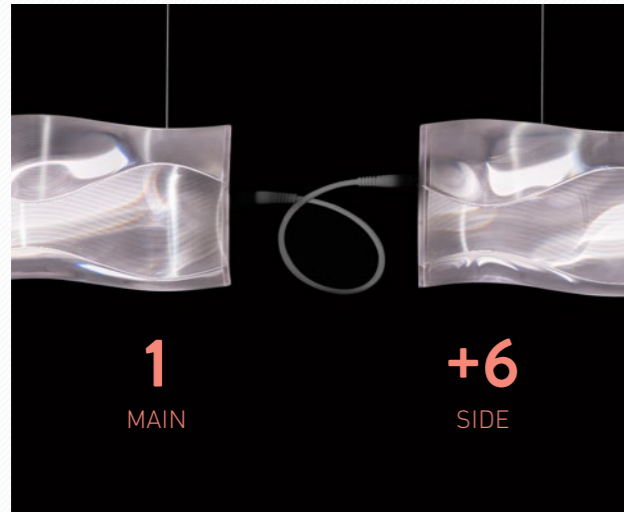

CONNECTION CABLE
30 cm (11-3/4")

One to seven one-meter luminous modules can be connected through a single electrical output using cables, allowing the flexibility to position modules 30 cm (11-3/4") from one another at varying angles.

Da 1 a 7 moduli luminosi da un metro di lunghezza possono essere connessi tra loro tramite un unico attacco elettrico e dei cavi di collegamento. La flessibilità di quest'ultimi permette di posizionare i moduli fino a 30 cm di distanza tra loro e in diverse angolazioni.

COMPLIANT WITH THE UNI EN 12464-1:2011 STANDARD

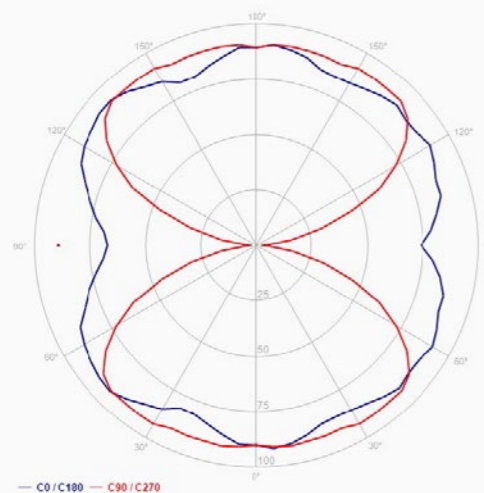

PHOTOMETRIC DIAGRAM, HUGO.
DIAGRAMMA FOTOMETRICO DELLA HUGO.

Hugo offers the same qualities of traditional technical lighting. The main office requirements established in the UNI EN 12464-1:2011 require an average illumination of 500 lx on work surfaces, a uniformity coefficient U0 greater than 0.6, and a glare value (UGR) of less than 19.

Hugo offre una qualità di luce paritetica a quella degli apparecchi per illuminazione tecnica. I principali requisiti illuminotecnici per gli uffici prevedono un livello di illuminamento medio sul piano di lavoro pari a 500 lx, un coefficiente di uniformità U0 maggiore di 0,6 e un valore di abbagliamento (UGR) minore di 19.

HOW TO MODULATE THE INSTALLATION



VERTICAL AND ORIZZONTAL MODULES,
WHITE AND PRISMA FINISHING

The Hugo collection includes both vertical and horizontal single modules, and the Architectural allows for up to 7 interconnected elements. The wide range of offer allows for creating unique, original, and easily installed solutions that can go beyond any limit.

La collezione Hugo include sia moduli orizzontali e verticali singoli, che il sistema Architectural fino a 7 elementi interconnessi. L'ampiezza della proposta permette di valicare i limiti del "finito" modulando facilmente installazioni originali e uniche.

ALIGNMENT ROD



If the composition requires further stability when the modules are positioned horizontally, 14,5 cm / 5-3/4" magnetic, transparent alignment rod are available.

Se la composizione ideata prevede un maggior rigore e si desidera allineare tra loro i moduli disposti in orizzontale, può essere fornita una barra di allineamento con attacco magnetico trasparente di 14,5 cm di lunghezza.

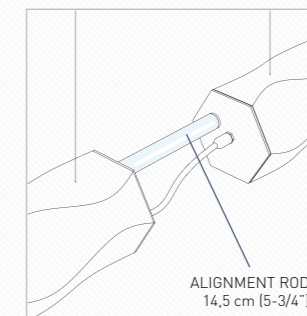

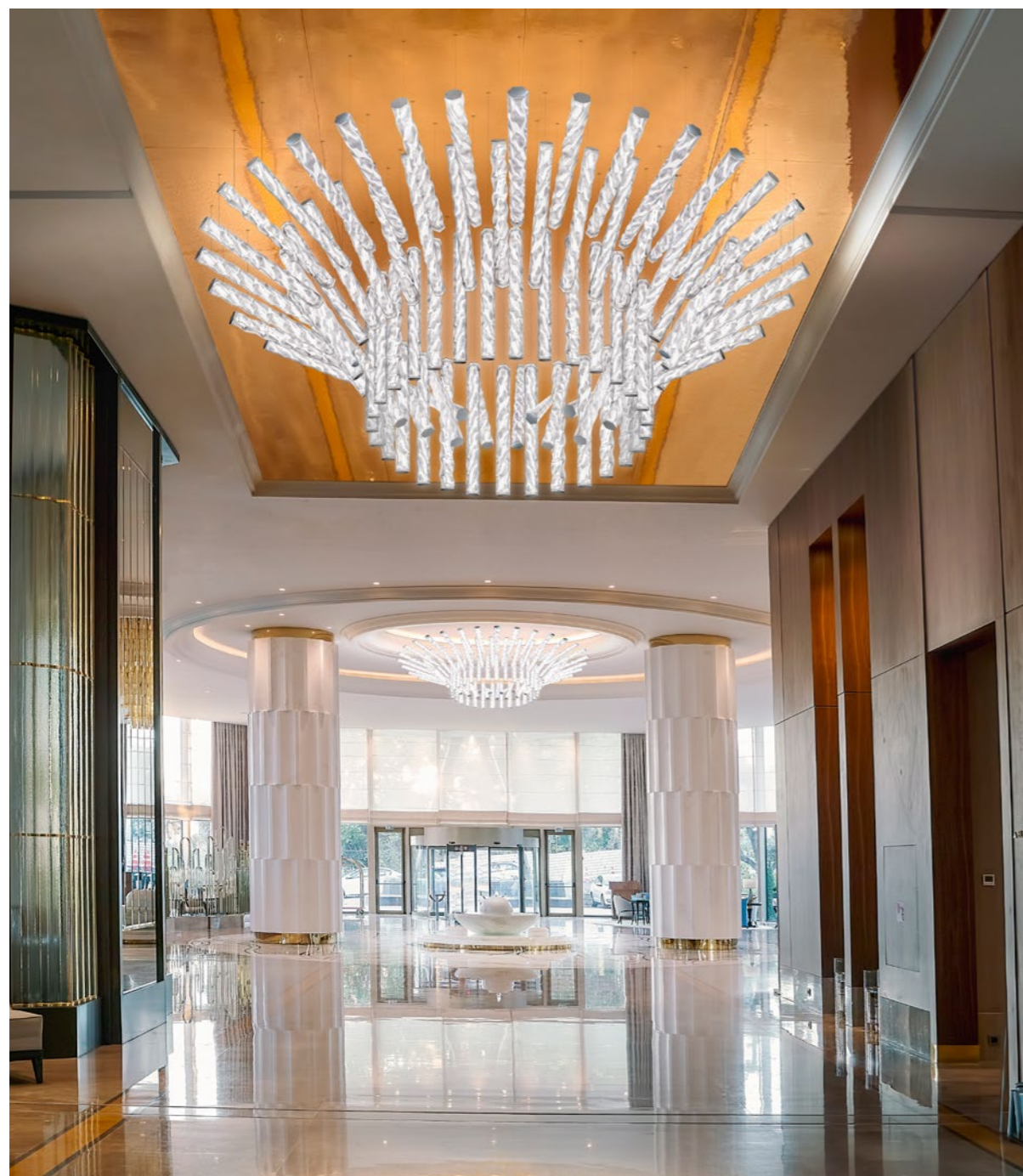

Multiple Hugo make a particularly dramatic statement within large spaces like hotels, conference halls, and shopping centers. In this picture, a composition of 80 modules.

Hugo è ideale in composizioni multiple particolarmente scenografiche per ambienti di grandi dimensioni come hall di alberghi, sale riunioni e centri commerciali. In questa composizione 80 moduli Hugo.



hugo

VERTICAL
BY SLAMP CREATIVE DEPARTMENT



technical details p. 533

SUSPENSION

Hugo Vertical Prisma

- 
 SUSPENSION
- 
 WALL LAMP
- 
 CEILING LAMP
- 
 TABLE LAMP
- 
 FLOOR LAMP
 p.460



Every module has a co-axis cables that create clean lines and simplified installation.

Ciascun modulo luminoso è dotato di cavo coassiale di appendamento per avere linee pulite e agevolare l'installazione.



HAND
MADE

IN ITALY

Lighting / Illuminazione:
25W - 100-240 Vac/24 Vdc - 3.500 lumen
3000 Kelvin, Dimmable [4000 Kelvin upon request]

hugo

BY SLAMP CREATIVE DEPARTMENT

technical details p. 533

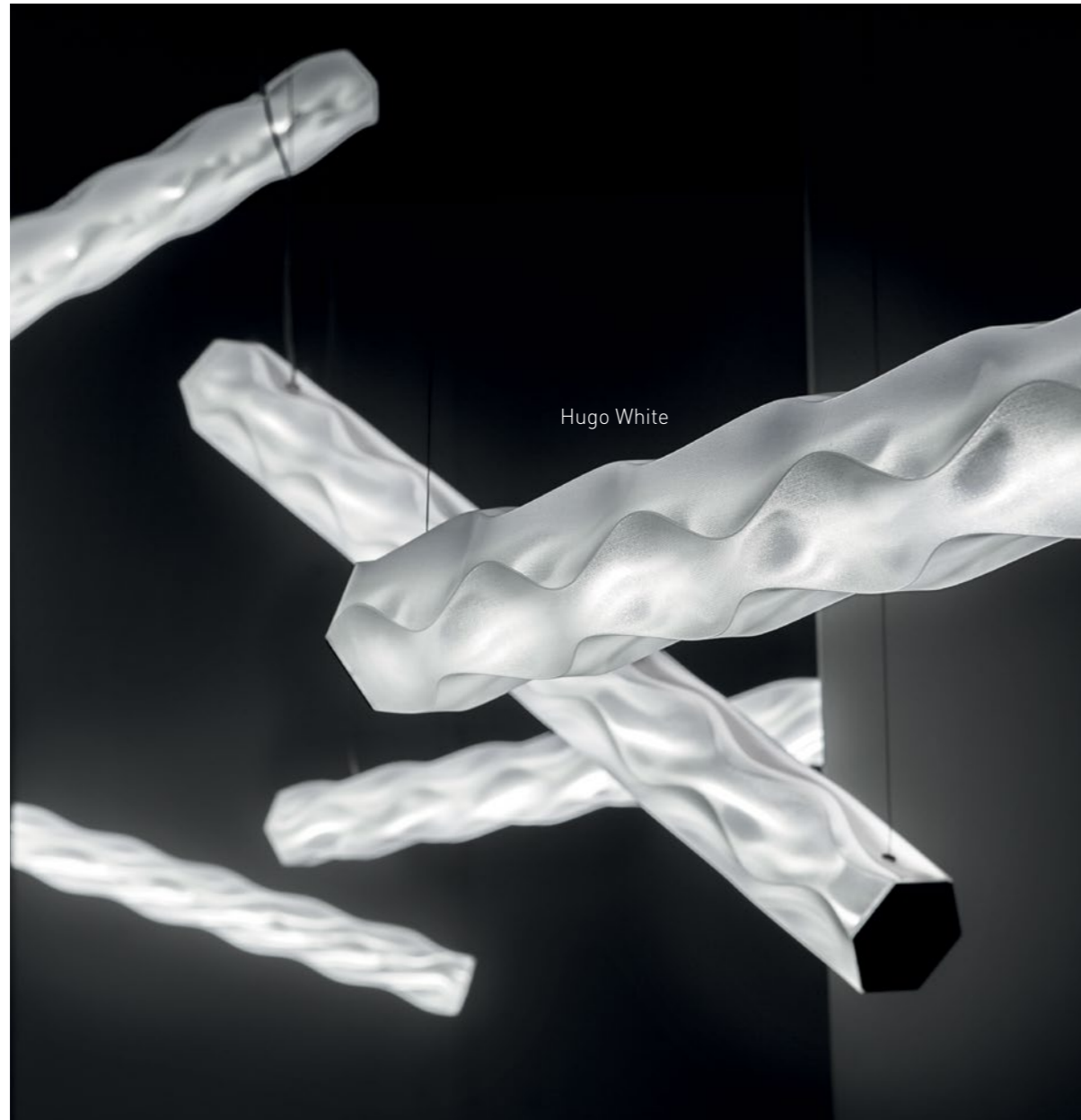

- 
 SUSPENSION
- 
 WALL LAMP
- 
 CEILING LAMP
- 
 TABLE LAMP
- 
 FLOOR LAMP
 p.460

Every module has two hanging points and co-axis cables that create clean lines and simplified installation; the 25W modules produce 3500 lumen. The integrated LED is softened and liquified by Slamp's unique prismatic Lentiflex®

Ciascun modulo, dotato di 2 punti di sospensione e cavo coassiale per rendere le linee pulite e agevolare l'installazione, sviluppa 3500 lumen con 25W. La luce dei LED integrati viene resa fluida e morbida dal materiale unico di Slamp: Lentiflex® nella versione Prisma e Lentiflex® con stampa effetto seta nella versione White.

suspension lamps

THERE IS SUCH ABUNDANT BEAUTY IN THIS WORLD
THAT WE NEVER STOP OBSERVING IT AND BRINGING
IT TO NEW SHAPES. THE FIRST RAY OF SUNSHINE
REFLECTED ON MORNING DEW, A BALLERINA'S
HEARTBEAT AS SHE PASSES THROUGH THE STAGE
CURTAINS, THE SMILE OF A TAILOR AS SHE SEES
HER PLEATED SILK VELVET, FRESHLY SEWN,
ON A MODEL...

C'È TALMENTE TANTA BELLEZZA IN QUESTO MONDO
CHE POTREMMO NON SMETTERE MAI DI OSSERVARLA
E DONARVELA SOTTO NUOVE FORME. IL COLORE DEL
PRIMO RAGGIO DI SOLE SU UNA GOCCIA DI RUGIADA
LASCIATA DALLA NOTTE, IL BATTICUORE DI UNA
BALLERINA CHE OLTREPASSA IL SIPARIO LA
SERA DELLA PRIMA, IL SORRISO DI UNA SARTA
CHE VEDE INDOSSATO IL VELLUTO DI
SETA APPENA PLISSETTATO...

SLAMP:

accordéon

BY MARC SADLER

technical details p. 514

SUSPENSION



Accordéon White



Accordéon Gold

Size /Dimensioni:
Ø57 x h. 20 cm
22-1/4" x h. 7-3/4"



PLAY VIDEO

-  SUSPENSION
-  WALL LAMP
-  CEILING LAMP
-  TABLE LAMP
p.312
-  FLOOR LAMP



Accordéon Silver

At first sight, it seems soft to the touch, almost silky, but the ring is made of unbreakable materials. The LED illuminates uniformly through prismatic Lentiflex®.

Ciò che a una prima occhiata appare morbido e setoso, è in realtà un anello materico, consistente e infrangibile. La luce dei LED si diffonde in modo uniforme grazie all'effetto prismatico del Lentiflex®.



Accordéon Gold



Lighting / Illuminazione:
 52W - 200 ~240V - 5900 Lumen
 Available 2700 Kelvin or 3000 Kelvin - Disponibile in versione 2700 Kelvin o 3000 Kelvin



Accordéon is hand folded, formed, and draped like material to clothe the illumination beneath.

Accordéon è realizzata scaldando il materiale unico di Stamp e drappeggiandolo a mano come fosse un tessuto.

SARTO
 RIAL
 PROCESS

accordéon VERTICAL

BY MARC SADLER



-  SUSPENSION
-  WALL LAMP
-  CEILING LAMP
-  TABLE LAMP
p.312
-  FLOOR LAMP



SAR TORIAL

PROCESSES



Accordéon Vertical Gold

Lighting / Illuminazione:
1 x 10W E14/E12 LED Filament bulb Ømax 5 cm (2")
Size/ Dimensions:
Ø11 x h. 30 cm - Ø4-1/4" x h. 11-3/4"



Accordéon Vertical Prisma

elisa
giovannoni

“LIGHT INFLUENCES
INSTINCTUAL EMOTIONS”

SLAMP:



kalatos

BY ELISA GIOVANNONI

technical details p. 536



Kalatos Black/Gold



Size /Dimensioni:
 Ø63 x h. 30 cm- Ø24-1/2" x h. 11-3/4"

Kalatos Prisma and
 Prisma Lentiflex® detail.

Kalatos Prisma e un dettaglio del
 Lentiflex® nella versione Prisma.



SUSPENSION

WALL LAMP

CEILING LAMP
 p.252

TABLE LAMP

FLOOR LAMP



Kalatos Prisma bottom view/ vista dal basso.

Kalatos is clearly inspired by the art of weaving baskets and cane sacks, a traditional domestic art that has been a part of humankind since prehistoric times. The collection is a high-tech take on this artisan craft, using Slamp's unique technopolymers; suspension and ceiling versions are available.

Il design di Kalatos è di chiara ispirazione all'arte dell'intreccio, espressione dell'artigianato artistico tradizionale che l'uomo porta con sé da quando, nella preistoria, intrecciava fibre vegetali per dar vita a cesti e canestri. Rivisitata in chiave high-tech, dato l'utilizzo dei tecnopolimeri di Slamp, la collezione si compone di una versione a sospensione e una plafoniera.



technical details p. 536

Kalatos Black/Gold



Kalatos Black/Gold

THE
ART OF
WEA
VING



atmosfera

BY LORENZA BOZZOLI

technical details p. 516



Atmosfera Pewter

There are 2 light sources, one in the spherical diffusor, and the other in the metallised base. The decorative polkadot punches are a result of layering two sheets of Goldflex® or Pewterflex®, both flexible technopolymers.

L'emissione della luce avviene da 2 fonti luminose: una nel diffusore sferico e una nel corpo metallizzato traforato con un effetto decorativo a pois ottenuto tramite la sovrapposizione di 2 strati di Goldflex® o Pewterflex®, tecnopolimeri flessibili.

Size /Dimensioni:
Ø30 x h 44,5cm
Ø11 3/4" x h. 17 1/4"



Atmosfera Gold

POLKA
DOTS

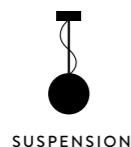

SUSPENSION



WALL LAMP



CEILING LAMP



TABLE LAMP
p.336



FLOOR LAMP



A cascade of Atmosfera Gold in the centre of the NOHOW headquarter's spiral staircase. Space owned by fashion influencer Mariano di Vaio.

Una cascata di Atmosfera Gold al centro di una scala a spirale, presso l'headquarter di NOHOW, azienda del fashion influencer Mariano di Vaio



technical details p. 516

Atmosfera Gold

clizia

MAMA NON MAMA

BY ADRIANO RACHELE

technical details p. 525

SUSPENSION



Clizia Large

Size /Dimensioni:
 Large: Ø78 cm x h. 28 cm - Ø30-3/4" x h. 11"
 Medium: Ø53 cm x h. 25 cm - Ø20-3/4" x h. 9-3/4"

- 
 SUSPENSION
- 
 WALL LAMP
 p.418
- 
 CEILING LAMP
 p.282
- 
 TABLE LAMP
 p.342
- 
 FLOOR LAMP



Clizia Mama Non Mama is an ode to joy, femininity, primordial love, and pure emotion, handcrafted from interlocking Cristalflex® petals.

Realizzata a mano tramite un sistema di incastri di Cristalflex® è un inno alla gioia, alla femminilità, all'amore primordiale, alla purezza dei sentimenti.

LOVES
ME,
LOVES ME NOT



clizia

PIXEL
BY ADRIANO RACHELE

technical details p. 525



Lighting / Illuminazione:
Large: 4 x 12W E27/E26
LED Filament Bulbs
Medium: 2 x 12W E27/E26
LED Filament Bulbs

The red hanging wire gives a creative touch, but for those looking for something minimal, a transparent one is available.

Il cavo rosso, che aggiunge al prodotto un guizzo creativo, può essere richiesto anche trasparente



clizia FUMÉ

BY ADRIANO RACHELE

technical details p. 525

SUSPENSION



SUSPENSION



WALL LAMP
p.422



CEILING LAMP
p.286



TABLE LAMP
p.344



FLOOR LAMP
p.480



Slamp's handmade approach is a precise ritual of cuts, folds and bends that transform a flat technopolymer sheet into a decorative three-dimensional shape.

L'allestimento manuale delle lampade Slamp segue una precisa ritualità che trasforma, tramite tagli, incastri e piegature una lastra piana di tecnopolimero in un volume tridimensionale.



Lighting / Illuminazione: L: 4 x 12W E27/E26 LED Filament Bulbs; M: 2 X 12W E27/E26 LED Filament Bulbs

Size/Dimensioni: L: Ø78 cm x h. 28 cm Ø30-3/4" x h. 11" ; M: Ø53 cm x h.25 cm Ø20-3/4" x h. 9-3/4



Cristalflex® is shiny and transparent as crystal, but light, unbreakable and flexible as a polycarbonate.

Il Cristalflex® è brillante e trasparente come il cristallo ma leggero e infrangibile come il policarbonato.

clizia

BY ADRIANO RACHELE

technical details p. 525

SUSPENSION



Clizia Large Black



Clizia Medium White

The magnetic hanging system allows the decorative shade to be removed and replaced with a simple click, facilitating installation and maintenance.

Grazie all'attacco magnetico, il decoro si stacca dalla fonte luminosa con un semplice click per facilitare l'installazione e la pulizia del diffusore.

- 
SUSPENSION
- 
WALL LAMP
p.424
- 
CEILING LAMP
p.288
- 
TABLE LAMP
p.348
- 
FLOOR LAMP
p.480



Clizia Large Orange

Clizia is one of Slamp's iconic collections, taking its name from an elegant and graceful nymph immersed in nature. Every version is handcrafted by Slamp's selected artisans, and every petal is hand placed into a lush bouquet.

Clizia - collezione iconica di Slamp - prende il nome dalla ninfa mitologica da cui eredita grazia, eleganza e naturalezza. Tutte le versioni di Clizia sono allestite a mano dalle Sarte della Luce di Slamp incastrando i vari petali fino a creare un volume rigoglioso.



Clizia Purple detail

Clizia Large White

Size/Dimensioni:
 L: Ø78 cm x h. 28 cm
 Ø30-3/4" x h. 11"
 M: Ø53 cm x h.25 cm
 Ø20-3/4" x h. 9-3/4"

lorenza bozzoli

“LIGHT MAKES
A COLOURFUL WORLD”

SLAMP:



la lollona

BY LORENZA BOZZOLI

technical details p. 537

SUSPENSION



La Lollona White



La Lollona Gradient

THE GLAMOUR OF
OPULANCE

-  SUSPENSION
-  WALL LAMP
p.414
-  CEILING LAMP
-  TABLE LAMP
-  FLOOR LAMP
p.464



La Lollona Pewter/White

Extraordinary view, easy to install: La Lollona is shipped assembled. All there is left to do is to connect and hang it, basking in its glow. The five tier version reaches 130 cm, with 132 cylinders available in a selection of colours and finishes. The suspension's colours and size can be customised upon request, fitting for large scale installations.

Facile da installare e straordinaria da ammirare: La Lollona viene spedita completamente pre-allestista lasciando al cliente il solo compito di sospenderla, fare i collegamenti elettrici e godere della sua spettacolarità. Nella versione a 5 livelli, si raggiunge il diametro di 130 cm con 132 cilindri disponibili in varie colorazioni e finiture. Customizzabile su richiesta - sia nei colori che nelle taglie - per progetti di larga scala.



technical details p. 537

La Lollona Gold

la lollo XL

BY LORENZA BOZZOLI



La Lollo XL White



SUSPENSION



WALL LAMP
p.414



CEILING LAMP



TABLE LAMP



FLOOR LAMP
p.464

technical details p. 537



La Lollo XL Gradient

Size / Dimensioni: Ø80 x h. 83 cm - Ø31-1/2" x h. 32-1/2"

Lighting / Illuminazione: LED 130W-110-240Vac/24 Vdc, 15000 Lumen, 2700 K - Dimmable

la lollo LARGE

BY LORENZA BOZZOLI

technical details p. 537



La Lollo Large Gold



La Lollo Large White

The techno-polymer cylinders alternate around a central LED illuminated ring.

Una serie di cilindri di tecnopolimeri, infrangibili e leggeri sono disposti intorno ad un anello di luce a LED.

- 
 SUSPENSION
- 
 WALL LAMP
 p.414
- 
 CEILING LAMP
- 
 TABLE LAMP
- 
 FLOOR LAMP
 p.464

la lollo MEDIUM

BY LORENZA BOZZOLI



La Lollo Medium Gold



SUSPENSION



WALL LAMP
p.414



CEILING LAMP



TABLE LAMP



FLOOR LAMP
p.464



technical details p. 537

La Lollo Medium
Pewter/White

la belle étoile

BY ADRIANO RACHELE

technical details p. 536

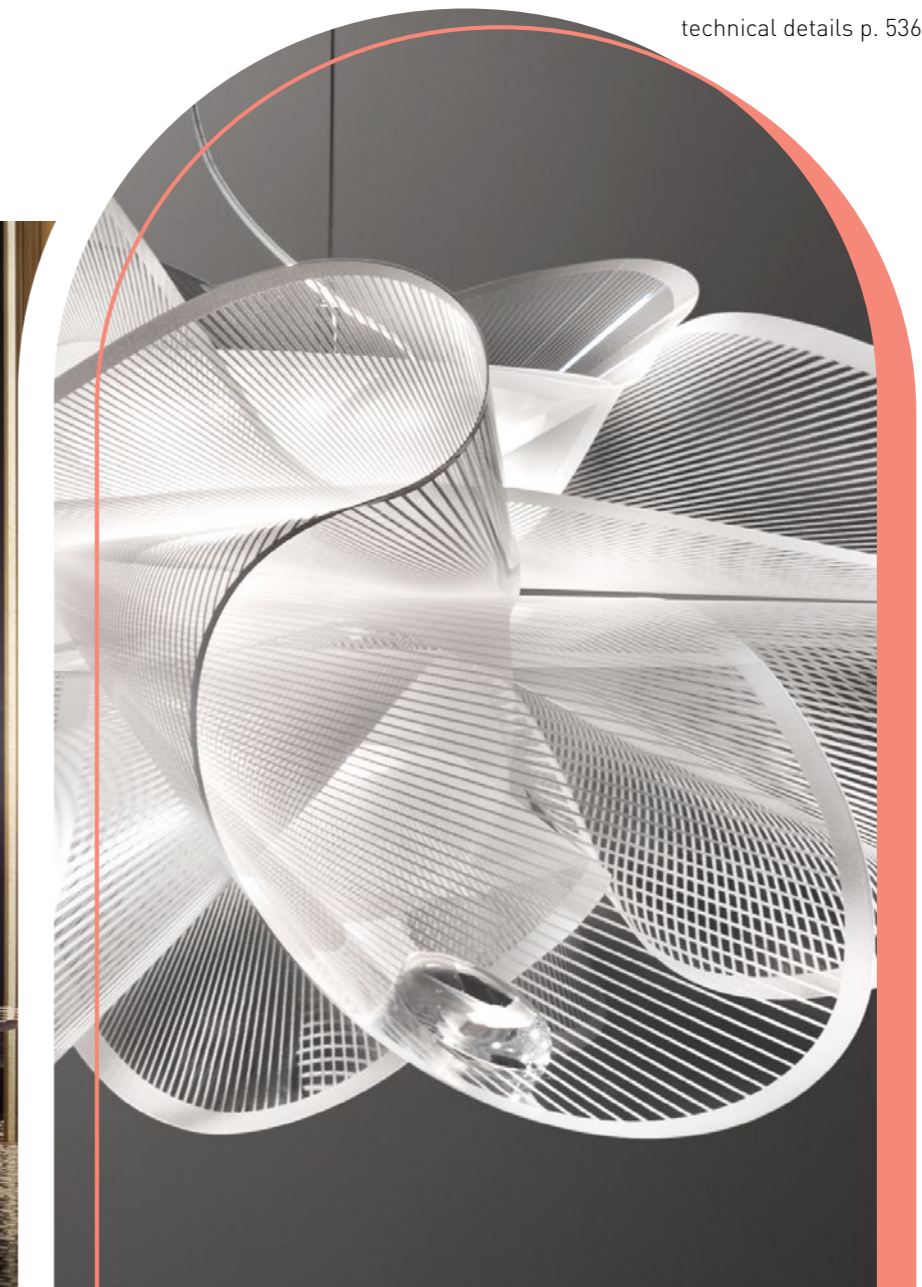

Crystal counter-balance "drop" included.
Contrappeso in cristallo incluso.

Size / Dimensioni:
L: Ø90 x 55 cm - 35-1/2" x h. 21-3/4"
M: Ø73 x h. 43 cm - 21" x h. 17-3/4"



PLAY VIDEO



SUSPENSION



WALL LAMP
p.436



CEILING LAMP
p.292



TABLE LAMP



FLOOR LAMP



Lighting / Illuminazione:
Large and Medium: 21W - 110-240 Vac/40 Vdc
2830 Lumen - 2700 Kelvin - CRI 90 - Dimmable



The finish is a non-toxic silk-screen print on Cristalflex®.

Il decoro è ottenuto mediante stampa serigrafica su Cristalflex® trasparente utilizzando inchiostri atossici.



BLACK
GRAPHICS



MAGNETIC

NETIC

LED SOURCE

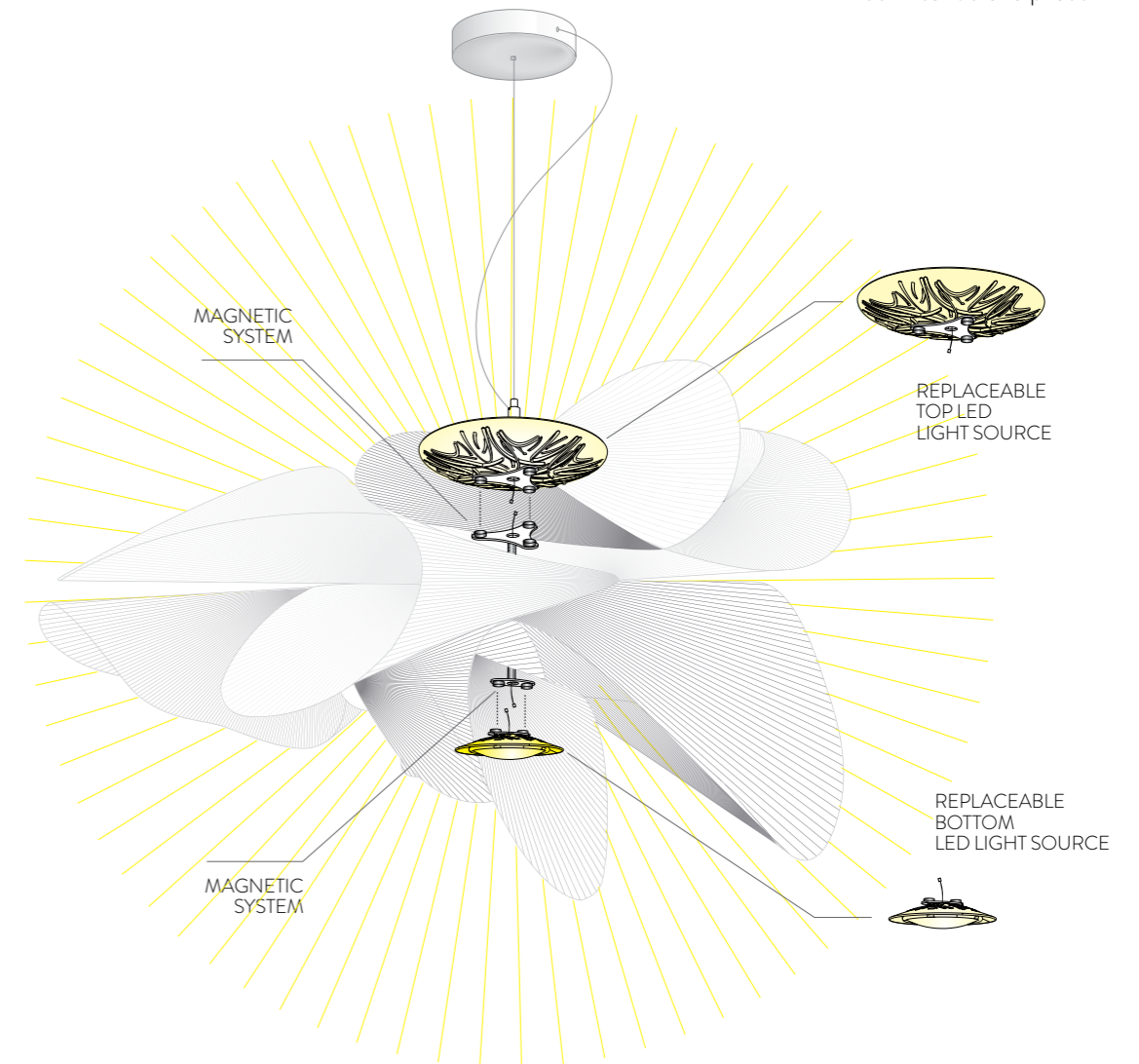

THE LED SOURCE CAN BE EASILY AND QUICKLY CHANGED

Light, dynamic, and as elegant as a twirling ballerina. La Belle Étoile is handmade by Slamp's artisans, experts in both manual art and technology. The ad hoc LED source can be easily changed thanks to Slamp's patented magnetic system.

Dinamica, leggera ed elegante come una ballerina dai volteggi aggraziati. La Belle Étoile è realizzata a mano dalle Sarte della Luce di Slamp, unendo artigianalità e tecnologia: il circuito a LED realizzato ad hoc è sostituibile tramite il sistema magnetico brevettato da Slamp.

étoile

BY ADRIANO RACHELE

technical details p. 529



Lighting / Illuminazione:
Large and Medium: 21W - 110-240 Vac/40 Vdc
2830 Lumen - 2700 Kelvin - CRI 90 - Dimmable

Size / Dimensioni:
L: Ø90 x 55 cm - Ø35-1/2" x h. 21-3/4"
M: Ø73 x h. 43 cm - Ø21" x h. 17-3/4"



SUSPENSION



WALL LAMP
p.438



CEILING LAMP
p.294



TABLE LAMP



FLOOR LAMP

veli FOLIAGE

BY ADRIANO RACHELE

technical details p. 548



Size / Dimensioni:
 L: Ø55 cm x h. 45 cm Ø21-1/2" x h. 17-1/2"
 M: Ø45 cm x h. 35 cm Ø17-1/2" x h. 13-3/4"

- 
 SUSPENSION
- 
 WALL LAMP
 p.426
- 
 CEILING LAMP
 p.270
- 
 TABLE LAMP
 p.360
- 
 FLOOR LAMP



Lighting / Illuminazione: L: 4 x12W LED Filament Bulb E27/E26 - M: 2 X12W LED Filament Bulb E27/E26
Available with red wrapped wire or transparent wire.
Disponibile sia con cavo di tessuto rosso calzato che trasparente.



ODE
TO OUR PLANET

veli COUTURE

BY ADRIANO RACHELE



Veli Couture with red wrapped wire

technical details p. 546



Veli Couture with transparent wire

Couture finish detail

A soft finish that was inspired by modern fabric textures.
Inedita finitura ispirata alle texture tessili contemporanee.

- 
 SUSPENSION
- 
 WALL LAMP
 p.428
- 
 CEILING LAMP
 p.272
- 
 TABLE LAMP
 p.362
- 
 FLOOR LAMP

veli mini COUTURE

BY ADRIANO RACHELE

technical details p. 546

SUSPENSION



Veli Mini Trio



Veli Mini Quartet



Veli Mini Single



PLAY VIDEO

- 
 SUSPENSION
- 
 WALL LAMP
 p.428
- 
 CEILING LAMP
 p.272
- 
 TABLE LAMP
 p.362
- 
 FLOOR LAMP

veli GOLD, SILVER AND COPPER

BY ADRIANO RACHELE

technical details p. 546



Veli Copper Collection at Erwin Restaurant, Moscow



Veli Silver

Absolute prestige and versatility for both domestic and contract design.
Handcrafted of noble, luxurious technopolymers.

Un must-have per conferire ad ambienti domestici e contract una lusso e prestigio. Realizzate a mano con tecnopolimeri nobili, lucenti e preziosi.

- 
 SUSPENSION
- 
 WALL LAMP
 p.434
- 
 CEILING LAMP
 p.276
- 
 TABLE LAMP
- 
 FLOOR LAMP

veli PRISMA

BY ADRIANO RACHELE

technical details p. 546



Lighting / Illuminazione:
 M: 2 x 12W LED Filament Bulb E27/E26
 L: 4 x 12W LED Filament Bulb E27/E26.
 Integrated magnetic system / Con attacco magnetico.

- 
 SUSPENSION
- 
 WALL LAMP
 p.432
- 
 CEILING LAMP
 p.274
- 
 TABLE LAMP
- 
 FLOOR LAMP



FRESNEL EFFECT

Lentiflex®'s Fresnel effect is created with micro-prisms that capture surface light, directing and diffusing fluidity.
 L'effetto Fresnel della superficie del Lentiflex® è dato dalla capacità dei micro prismi di cui è realizzata la sua superficie di catturare la luce e la direzionarla creando effetti diffondenti e fluidi.

veli

BY ADRIANO RACHELE

technical details p. 546

SUSPENSION



SUSPENSION



WALL LAMP
p.430



CEILING LAMP
p.278



TABLE LAMP
p.362



FLOOR LAMP



Lighting / Illuminazione:
L: 4x12W LED Filament Bulb E27/E26
M: 2x12W LED Filament Bulb E27/E26

Integrated magnetic system.
Dotata di attacco magnetico.

veli7

BY ADRIANO RACHELE

technical details p. 547



-  SUSPENSION
-  WALL LAMP
p.430
-  CEILING LAMP
p.278
-  TABLE LAMP
p.362
-  FLOOR LAMP

Lighting /Illuminazione: 9 x 12W LED Filament Bulb E27/E26.
Electric wire 400 cm /156" ; Cavo elettrico di 400 cm

hanami

BY ADRIANO RACHELE



Lighting /Illuminazione:
L: 10 X 5W G9 LED Bulbs
M: 5 X 5W G9 LED Bulbs



SUSPENSION



WALL LAMP
p.412



CEILING LAMP
p.290



TABLE LAMP



FLOOR LAMP



CHERRY

BLOSSOMS



Stella Island Luxury Suites and Spa, Creta, Greece



Flowers folded by hand, each made from Lentiflex[®], a noble, unbreakable material that shines like a precious stone.

Fiori plissettati a mano in Lentiflex[®], materiale nobile e infrangibile con riflessi di un diamante.

Size / Dimensioni:

L: 96 x 60 x h.26 cm - 37-3/4" x 23-1/2" x h.10-1/4"

M: 53 x 35 x h.25 cm - 20-3/4" x 13-3/4" x h.9-3/4"

flora

BY ZANINI DE ZANINE



Flora Gold Medium

idea ^{IDS A} BRASIL '14
AWARD



SUSPENSION



WALL LAMP



CEILING LAMP



TABLE LAMP



FLOOR LAMP

p.488

Flora Small White

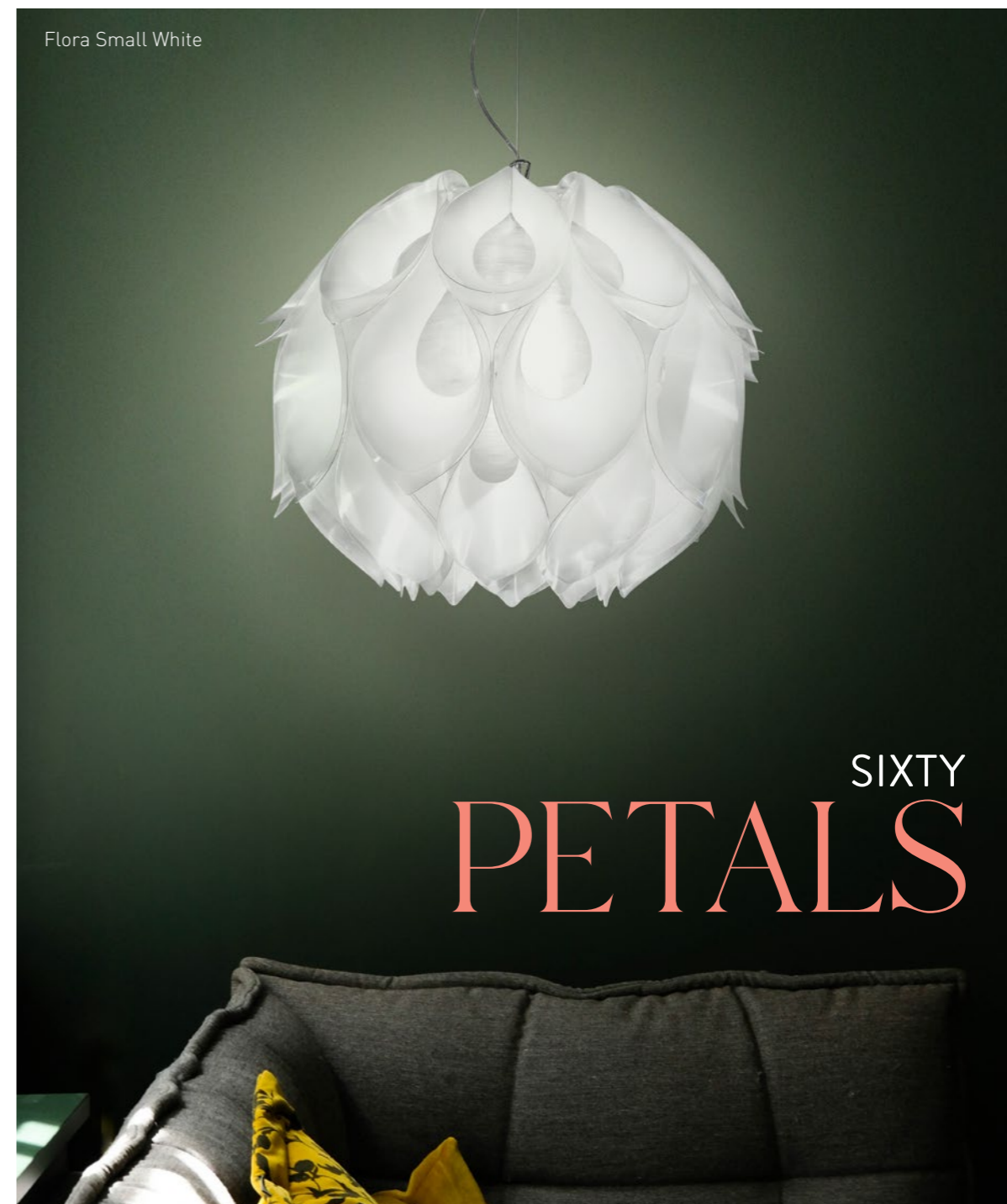

SIXTY
PETALS

60 petals surround a hand-finished sphere illuminated from its core.
La sfera luminosa è circondata da 60 petali ed è satinata a mano.



In a land kissed by the sun, and a natural world filled with colour, artisan expertise brings life to highly expressive pieces dense with archetypes, like Flora, the collection inspired by the Monstera Deliciosa plant. Available in 2 dimensions and 5 colours.

In una terra baciata dal sole, dove natura, maestria artigiana e colori danno vita a segni altamente espressivi e densi di archetipi, nasce Flora, collezione ispirata alla pianta Monstera Deliciosa. Disponibile in 2 dimensioni e 5 finiture.



Flora Medium White

fabula

BY COSTANTINO MOROSIN



Fabula Large



SUSPENSION



WALL LAMP
p.450



CEILING LAMP
p.298



TABLE LAMP



FLOOR LAMP

technical details p. 529



Handmade with Lentiflex®, Fabula appears to be a long, silky piece of fabric wound around itself.

Realizzata a mano concatenando elementi di Lentiflex®, Fabula ricorda una lunga e soffice fascia di seta avvolta su se stessa.



ceremony

BY BRUNO RAINALDI

technical details p. 522



Acquisition Gala Dinner
Maxxi Museo Internazionale
delle arti del XXI secolo, Rome



SUSPENSION

WALL LAMP

CEILING LAMP

TABLE LAMP

FLOOR LAMP

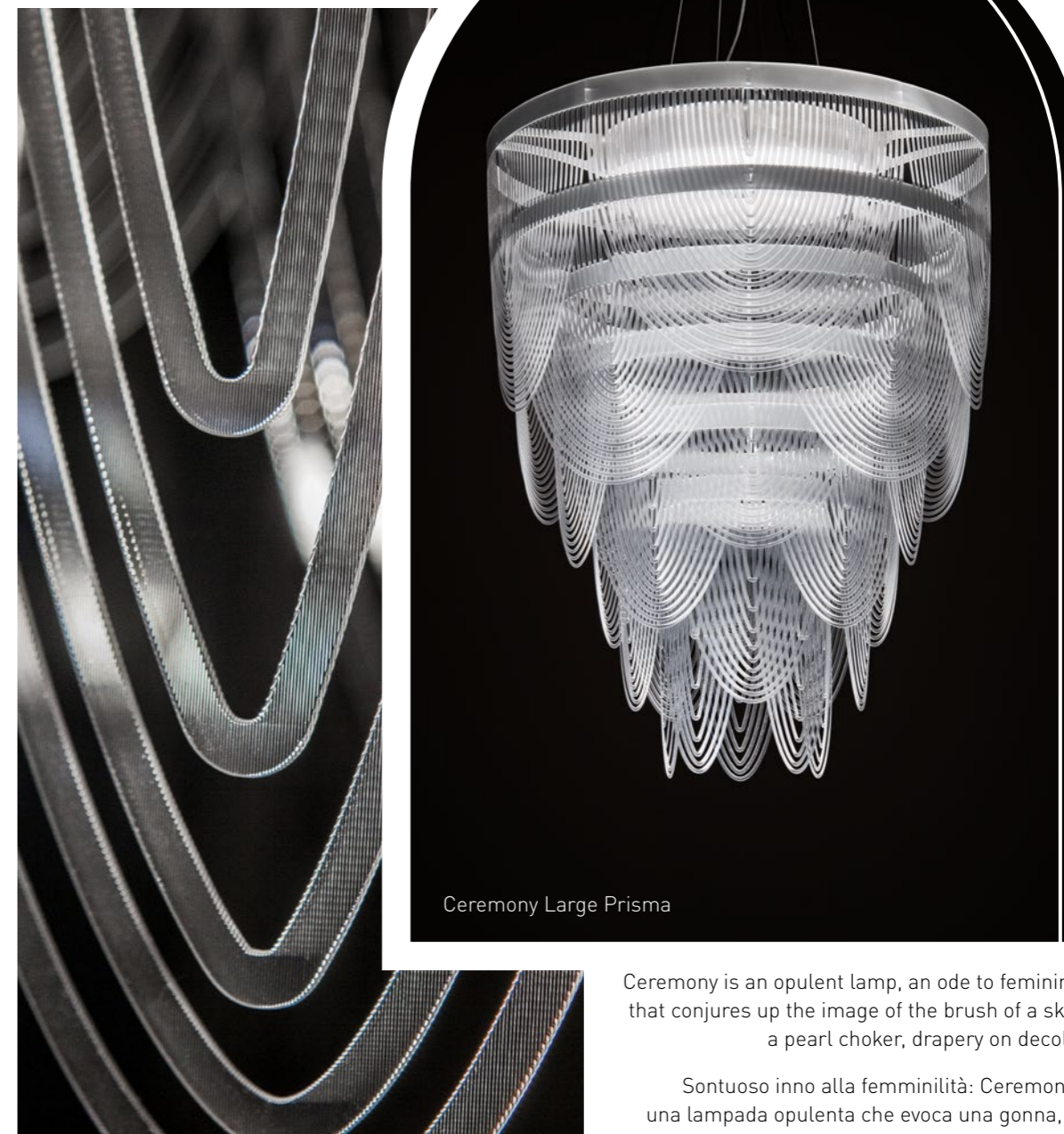

Ceremony Large Prisma

Prisma finish detail

Ceremony is an opulent lamp, an ode to femininity that conjures up the image of the brush of a skirt, a pearl choker, drapery on decolletè.

Suntuoso inno alla femminilità: Ceremony è una lampada opulenta che evoca una gonna, un ballo, una collana di perle, il drappeggio di una scollatura.

drusa

BY ADRIANO RACHELE

technical details p. 528

SUSPENSION



Drusa Velvet at Stella Island Luxury Suites and Spa Creta, Greece



Drusa White

Drusa draws inspiration from crystals poking out from the rocks; they exhibit a poetic and multiform kaleidoscope when hit by the light.

Drusa trae ispirazione dai cristalli incastonati nelle rocce che, toccati dalla luce, manifestano un'anima poetica e multiforme.



SUSPENSION



WALL LAMP
p.440



CEILING LAMP
p.296



TABLE LAMP



FLOOR LAMP

supermorgana

BY STEFANO PAPI

technical details p. 544

SUSPENSION



Laurichhof Design Hotel,
Germany

Lighting /Illuminazione: 1 x 5W G9 LED bulb
Size/ Dimensioni: 45 x h. 58 cm - 17-3/4" x h. 22-3/4"



SUSPENSION

WALL LAMP

CEILING LAMP

TABLE LAMP

FLOOR LAMP



Clarion Sense Restaurant,
Sweden

Supermorgana Black/Gold

MAGICAL
REFLECTIONS

cactus

BY ADRIANO RACHELE

technical details p. 520



IRONIC

GLOW

Lighting / Illuminazione: 1 x 12W E27/E26 LED Filament bulb

Size / Dimensioni: Ø50 x h. 27 cm - Ø19-3/4" x h. 10-3/4"

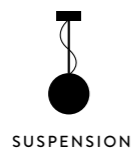

SUSPENSION



WALL LAMP



CEILING LAMP



TABLE LAMP
p.370



FLOOR LAMP
p.482

lilibet

BY NIGEL COATES

technical details p. 540



Lilibet Gold



Lilibet Silver

Lighting / Illuminazione:

1 x 12W E27/E26 LED Filament bulb

Size / Dimensioni: Ø66 x h.47 cm - Ø26" x h.18"

56 Schöler crystals - Con 56 cristalli Schöler
Available in 7 finishes - Disponibili in 7 finiture.



SUSPENSION



WALL LAMP
p.454



CEILING LAMP



TABLE LAMP



FLOOR LAMP

goccia

BY STEFANO PAPI



Goccia Prisma

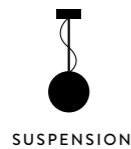

SUSPENSION



WALL LAMP



CEILING LAMP



TABLE LAMP



FLOOR LAMP



Goccia Fire

A
DROP
OF LIGHT

Available in 7 finishes - Disponibili in 7 finiture.
Lighting / Illuminazione: 1 x 12W E27/E26 LED Filament bulb

ginetta

BY NIGEL COATES



technical details p. 532



Ginetta is a classic 8-arm chandelier taken over by a digital evolution.
Ginetta è l'evoluzione digitale del classico candeliera a 8 bracci.
Lighting /Illuminazione: 1 x 12W E27/E26 LED Filament bulb

NEO
BAROQUE

luis

BY ADRIANO RACHELE

technical details p. 540

SUSPENSION



Luis Blue



Luis Gold

Inspired by the smallest bird in the world, Luis enchants with plays of shadow and reflection, and branches that envelop the light source.

Ispirata all'uccellino più piccolo del mondo Luis incanta per i suoi giochi di ombre e riflessi creati dai tanti rami che avvolgono la fonte luminosa.



fiorella

BY NIGEL COATES

technical details p. 530



Fiorella Mini Gold



NEVER ENDING
BOU
QUET

Fiorella White

-  SUSPENSION
-  WALL LAMP
p.448
-  CEILING LAMP
-  TABLE LAMP
p.364
-  FLOOR LAMP



Suggestive, realistic and welcoming; Fiorella suspension's natural details conjure up a world covered in flora. Slamp's expressive powers and fresh figurativism meet in a flurry of reflective, luminous petals.

Realistica, avvolgente e suggestiva con i suoi naturalistici dettagli conduce l'immaginazione verso un mondo floreale dove la realtà dei piccoli cespugli arruffati di bosso incontra la magia del fresco figurativismo e delle seducenti potenzialità espressive di Slamp.



Fiorella Suspension Mini Copper bottom view.

Vista dal basso di Fiorella Suspension Mini Copper.

woody

BY LUCA MAZZA

technical details p. 550

SUSPENSION



Woody White



Woody Orange

A collection inspired by nature: the knots and veins of a tree trunk are printed on the diffuser, mixing warm tradition with vivacious colours.

Una collezione ispirata alla natura, caratterizzata dalla stampa del decoro di nodi e venature sul diffusore per mixare il calore tradizionale del legno a colori briosi e pieni di vita.



SUSPENSION



WALL LAMP



CEILING LAMP



TABLE LAMP



FLOOR LAMP

atlante

BY NIGEL COATES



SUSPENSION



WALL LAMP



CEILING LAMP



TABLE LAMP

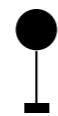

FLOOR LAMP
p.504



Lighting / Illuminazione: 8 x 15W max IBC/C E14/E12 bulbs

Size / Dimensioni: Ø51 x h. 38 cm - Ø20" x h. 15"

technical details p. 516

SUSPENSION

medusa

BY NIGEL COATES

technical details p. 541



Medusa Pewter



Restaurant 1718 - Deidesheim, Germany

56 CRYSTALS

Size / Dimensioni: Ø83 x h. 61 cm - Ø33-3/4" x h. 24"

liza

BY ELISA GIOVANNONI



Size/Dimensioni: Ø45 x 33 cm - Ø17-3/4" x h 12-3/4"



SUSPENSION



WALL LAMP



CEILING LAMP



TABLE LAMP
p.350



FLOOR LAMP

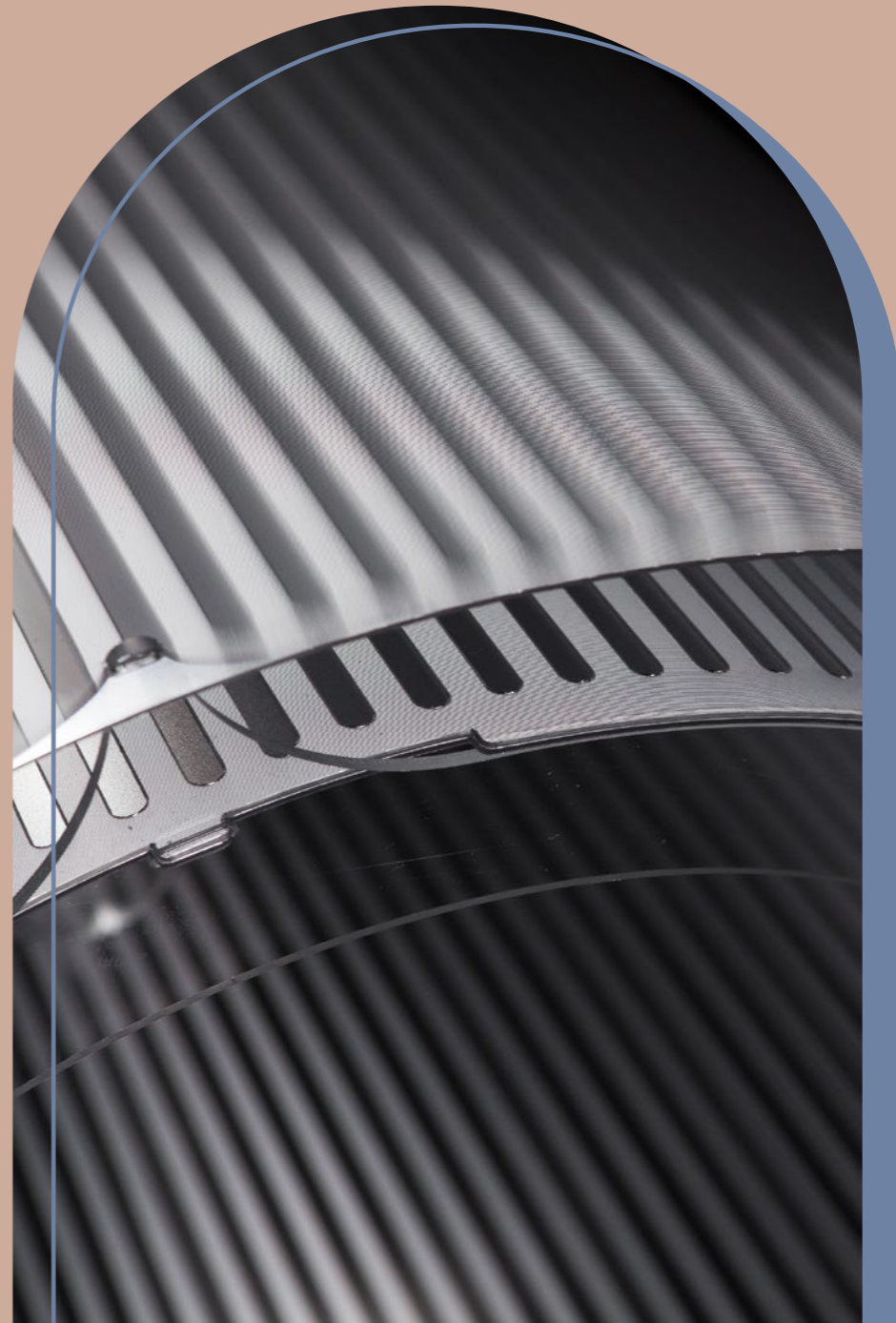

Liza suspension's internal perforated structure creates an elegant pattern, and the elongated form lends itself to multiple lamps positioned over dinner tables or kitchen islands.

La struttura interna traforata crea una trama elegante la cui forma longilinea si presta a inserimenti multipli su un tavolo da pranzo o sulla penisola di una cucina.

technical details p. 540

gemmy PRISMA

BY RAGNISCO, SPALLETTA, CROCE, WIJFFELS

technical details p. 532



Gemmy Prisma

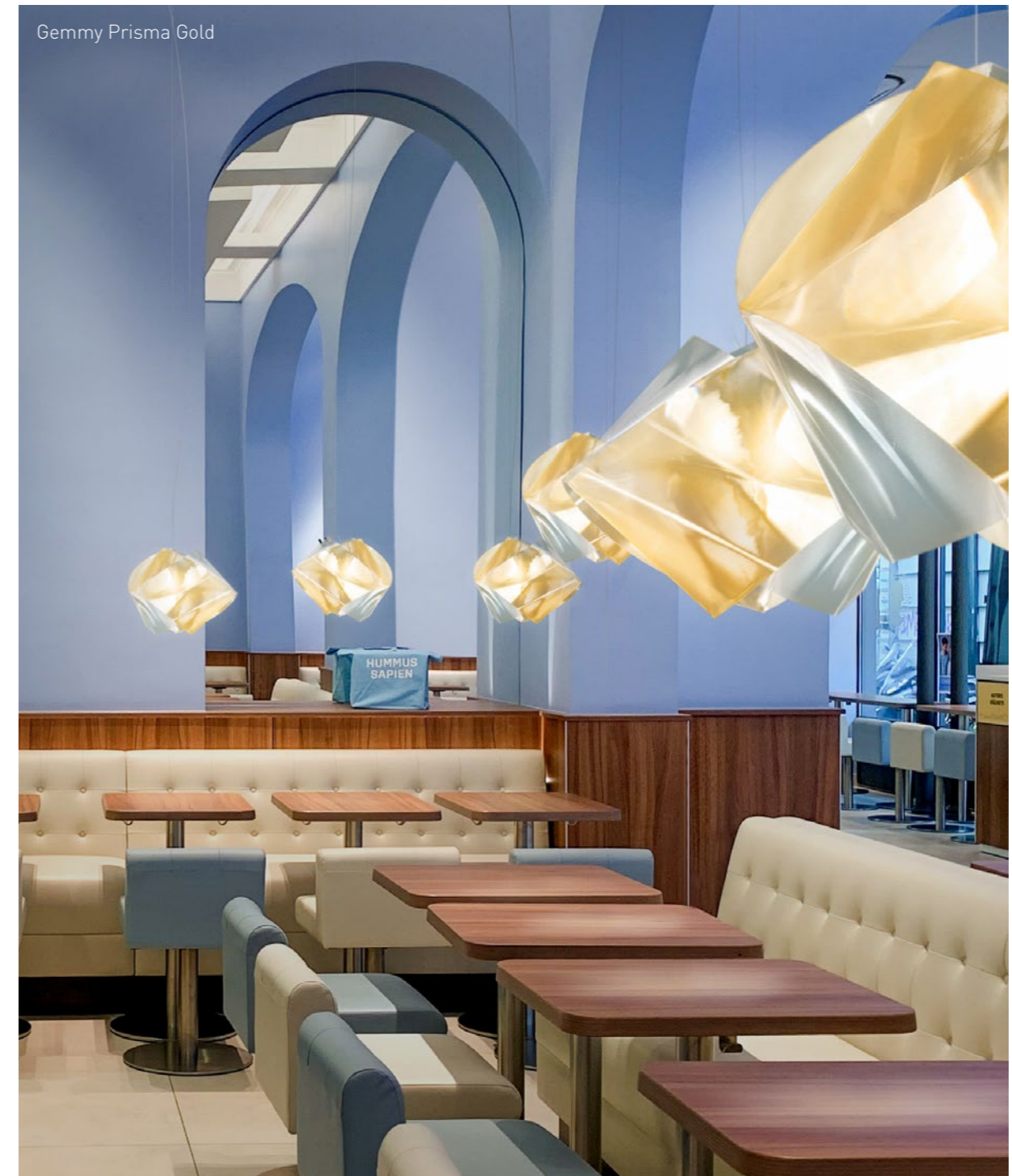

Gemmy Prisma Gold

Lighting / Illuminazione: 1 x 12W LED Filament Bulb E27/E26

Size / Dimensioni: Ø42 cm x h. 34 cm - Ø16" x h. 13"

gemmy

BY RAGNISCO, SPALLETTA, CROCE, WIJFFELS

technical details p. 532

SUSPENSION



Gemmy Multicolor
at Matisse Beach Club, Perth, Australia.



Gemmy Arlecchino

VERSATILE,
REFINED FACETS FOR
CONTEMPORARY INTERIORS

Available in 12 colours - Disponibile in 12 colori.

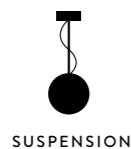

SUSPENSION



WALL LAMP



CEILING LAMP



TABLE LAMP
p.372



FLOOR LAMP

ceiling lamps

INSPIRED BY THE TRADITIONAL CEILING ROSE, CEILINGS OF THE RENAISSANCE DECORATED IN TROMPE-L'OEIL, AND DRAMATIC ART DECO CHANDELIERS IN THEATERS, WE'VE CREATED A CARNET OF OPTIONS FOR THOSE TAKEN BY THE UPWARD VIEW OF THE ORIGINAL, ICONIC DESIGN THAT SURROUNDS THEM.

ISPIRANDOCI AI ROSONI DELLE CASE D'EPOCA, AI TROMPE-L'OEIL DEI SOFFITTI RINASCIMENTALI, AGLI SCENOGRAFICI LAMPADARI DEI TEATRI ART DECO, ABBIAMO CREATO UN CARNET DI PROPOSTE PER CHI, COME IN BASSO COSÌ IN ALTO, SCEGLIE DI CIRCONDARSI DI DESIGN ORIGINALE E ICONICO.

SLAMP:

la vie

BY ADRIANO RACHELE

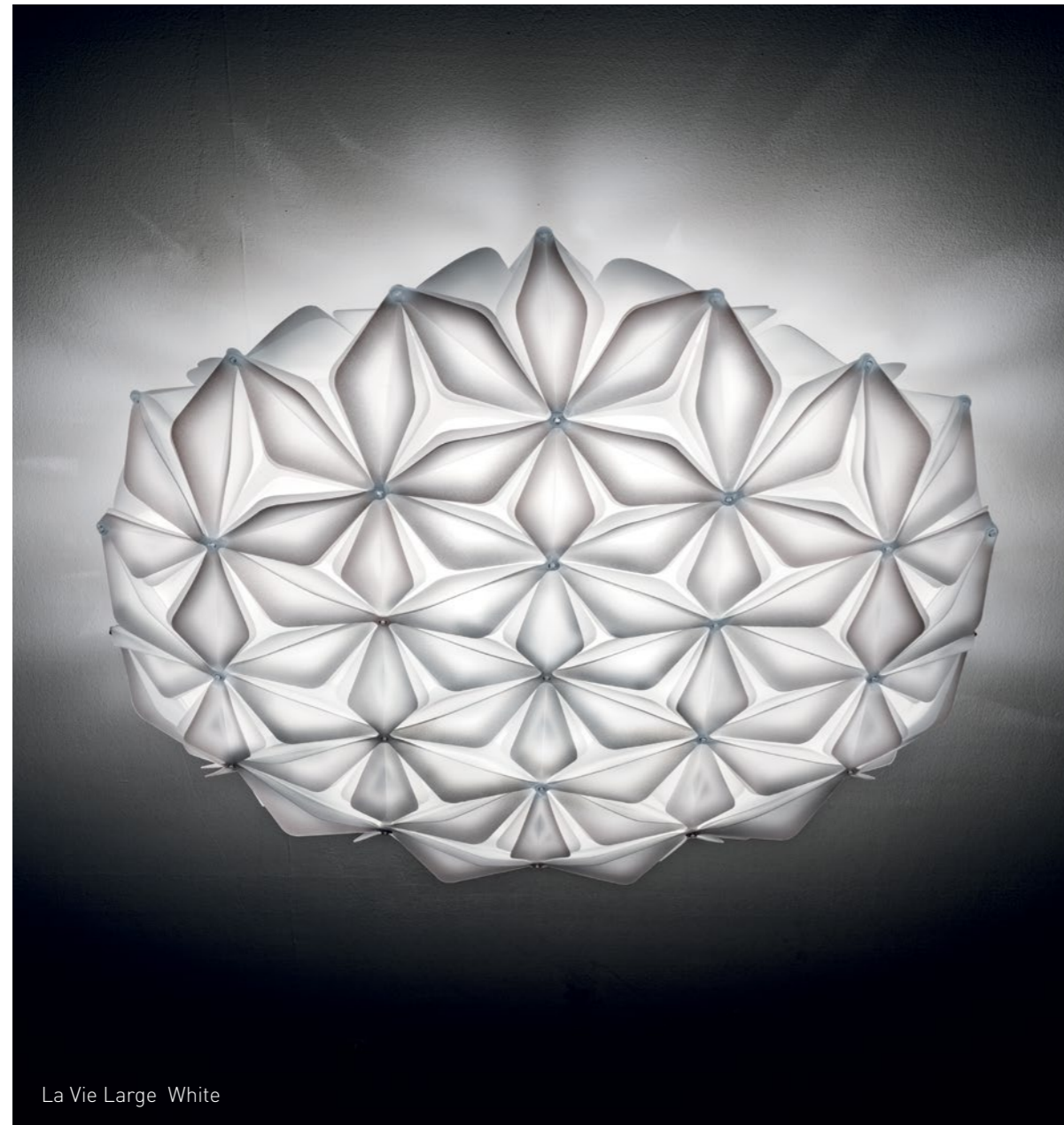

La Vie Large White



SUSPENSION



WALL LAMP
p.394



CEILING LAMP



TABLE LAMP



FLOOR LAMP

technical details p. 538



La Vie Large Blue

Size / Dimensioni:

Large: 71 x 74 x h. 21 cm - 27-3/4" x 29" x h. 8-1/4"
Medium: 47 x 50 x h. 19 cm - 19-1/2" x 18-1/4" x h. 7-1/2"
Mini: 34 x 36 x h. 15 cm - 13-1/4" x 14" x h. 5-3/4"



La Vie Large White



FLO WER OF LIFE



La Vie Medium Multiblue



La Vie Medium Multigreen

La Vie Medium is available in 5 color combinations (2 multicolor only for Medium version).
La versione Medium di La Vie è disponibile in 5 combinazioni cromatiche incluse due esclusive multicolore.



La Vie Large Amber

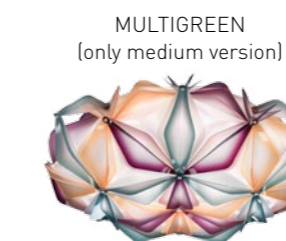
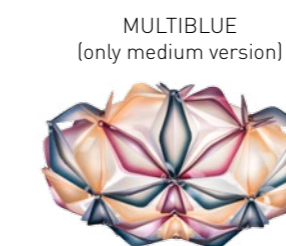
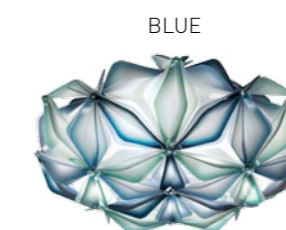
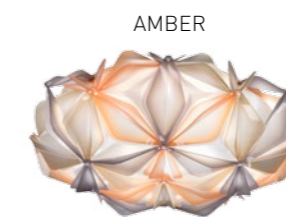

WHERE EVERYTHING EXISTS, AND EVERYTHING BEGINS

La Vie was inspired by the Flower of Life, equal to harmonious energy, a symbol of birth and beginnings, that vibrates life's frequencies. It is a three dimensional representation of all the materials in the universe, contained in a single object, the essence of everything.

Ispirata alla celebre simbologia del Fiore della Vita, La Vie è sinonimo di energia e armonia, è simbolo di inizio e di nascita, racchiude le frequenze della vita. È la raffigurazione tridimensionale di tutte le configurazioni che la materia che compone l'universo può avere. In un solo oggetto, l'essenza del tutto.

kalatos

BY ELISA GIOVANNONI



Kalatos Prisma bottom view
Vista dal basso di Kalatos Prisma



SUSPENSION
p.136



WALL LAMP



CEILING LAMP



TABLE LAMP



FLOOR LAMP

technical details p. 536



Size / Dimensioni: Ø63 x h. 30 cm - Ø24-1/2" x h. 11-3/4

CEILING LAMP

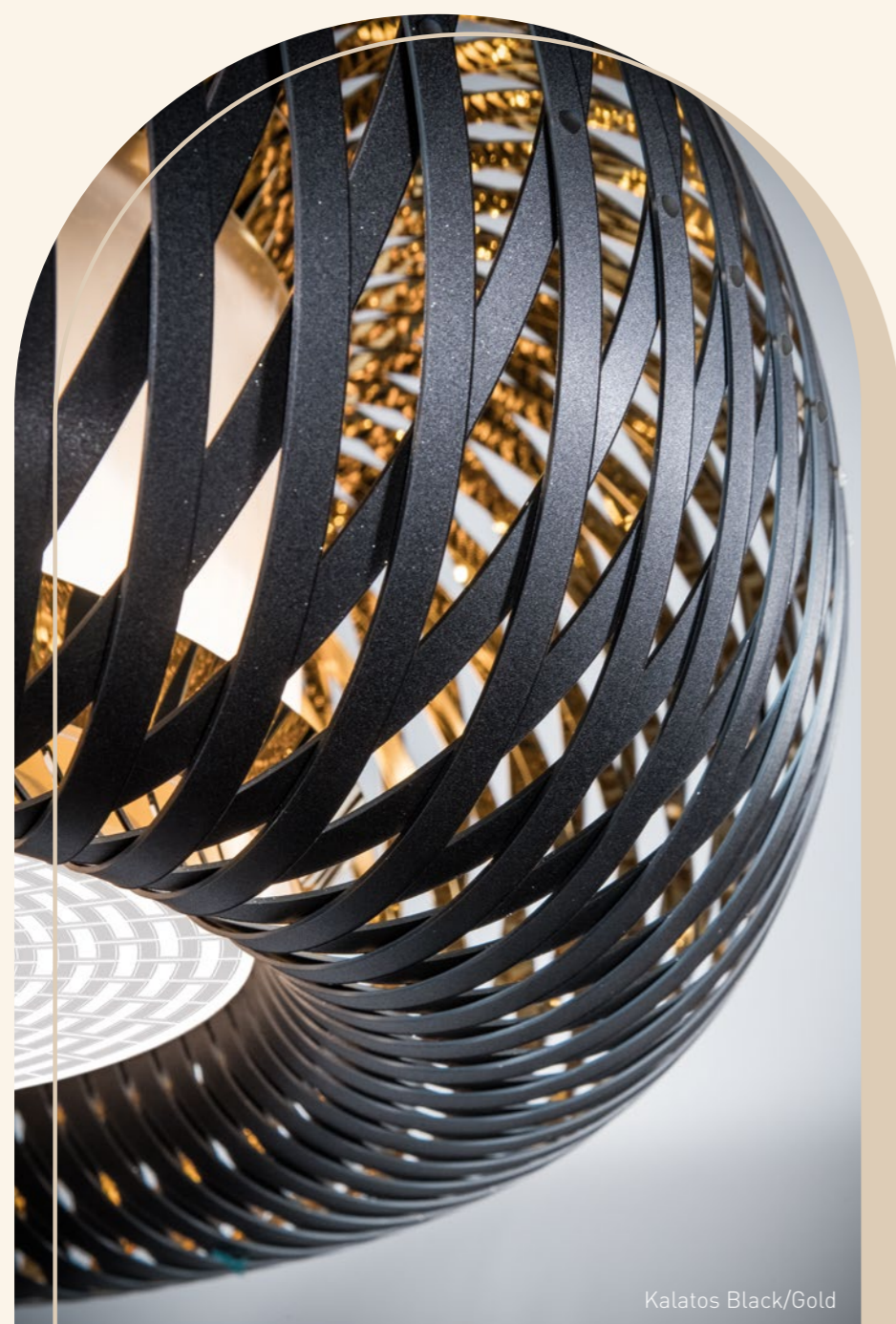

Kalatos Black/Gold

Lighting / Illuminazione: 4 x 12W - E27/E26 LED Filament Bulbs



HANDCRAFTED
WEAVING

adriano
rachele

“LIGHT IS POETRY”

SLAMP:



mida

BY ADRIANO RACHELE



Mida Medium Multicolor



SUSPENSION



WALL LAMP
p.388



CEILING LAMP



TABLE LAMP



FLOOR LAMP



Mida Medium Amber

technical details p. 541



LIKE A

JEWEL

Available in 5 colours, 3 sizes, 2 designs.
Diffusor with magnetic hanging system.

Disponibile in 5 colori, 3 dimensioni in 2 design alternativi.
Diffusore dotato di attacco magnetico.



Mida Amber detail

PRECIOUS MATERIALS



Mida Medium Silver



Mida Large Silver

WHITE / PLATINUM



WHITE / GOLD



ROSE



AMBER



MULTICOLOR



FROM THE WORLD OF HAUTE COUTURE JEWELS

A pavè of precious gems encrust an almost invisible setting, a polished cabochon geometrically scattered across a floral corolla with silky, iridescent tones. Available in five color combinations, each featuring a magnetic hanging system.

Ispirata ai pavè di pietre preziose incastonate su una struttura quasi invisibile, ai cabochon lisci e levigati che si dispongono in maniera ordinata a disegnare la corolla di un fiore dai colori cangianti e setosi. Disponibile in 5 combinazioni cromatiche, tutte con attacco magnetico.



PLAY VIDEO

odeon

BY LORENZA BOZZOLI



-  SUSPENSION
-  WALL LAMP
-  CEILING LAMP
-  TABLE LAMP
-  FLOOR LAMP





Lighting /Illuminazione:

Odeon 100: 12 x12W E27/E26 LED Filament bulbs + 1 x 6,5W E27/E26 Spot LED

Odeon 65: 6 x12W E27/E26 LED Filament bulbs + 1 x 6,5W E27/E26 Spot LED



Our in-house design team works daily with our specialized "tailors" to ensure fluid and linear manufacturing.

Il team di designer interni assiste giornalmente le operatrici specializzate per assicurare che l'assemblaggio manuale dei prodotti sia fluido e lineare.

Odeon 100



PRECIOUS MATERIALS



Odeon 65

Size /Dimensioni:
Odeon 100: Ø102 x h. 42 cm - Ø39-3/4" x h. 16-1/2"
Odeon 65: Ø65 x h. 33 cm - Ø25-1/4" x h. 13"

veli FOLIAGE

BY ADRIANO RACHELE



SUSPENSION
p.182

WALL LAMP
p.426

CEILING LAMP

TABLE LAMP
p.360

FLOOR LAMP

technical details p. 548



veli COUTURE

BY ADRIANO RACHELE

technical details p. 547



Couture finish detail

Integrated magnetic hanging system.
Ceiling version available in 3 sizes.

Dotata di attacco magnetico.
Plafoniera disponibile in 3 misure.

- 
SUSPENSION
 p.186
- 
WALL LAMP
 p.428
- 
CEILING LAMP
- 
TABLE LAMP
 p.362
- 
FLOOR LAMP

veli PRISMA

BY ADRIANO RACHELE

technical details p. 547



Veli Large Prisma



Veli Prisma detail

Lentiflex®'s Fresnel effect creates a fluid, illuminated effect that shimmers like a waterfall. .

L'effetto Fresnel del Lentiflex® permette di "fluidificare" la luce fino a riprodurre la sensazione della fluidità di una cascata d'acqua luminosa.

SUSPENSION
p.192

WALL LAMP
p.432

CEILING LAMP

TABLE LAMP

FLOOR LAMP

veli GOLD, SILVER AND COPPER

BY ADRIANO RACHELE

technical details p. 547



Veli Large Copper



Veli Medium Gold

- 
 SUSPENSION
p.190
- 
 WALL LAMP
p.434
- 
 CEILING LAMP
- 
 TABLE LAMP
- 
 FLOOR LAMP



Veli Copper Collection at Erwin Restaurant, Moscow, Russia.

CEILING LAMP

veli

BY ADRIANO RACHELE



Veli Medium Opal

-  SUSPENSION p.194
-  WALL LAMP p.430
-  CEILING LAMP
-  TABLE LAMP p.362
-  FLOOR LAMP

technical details p. 547



Veli Large Opal

SINU
OUS
DESIGN

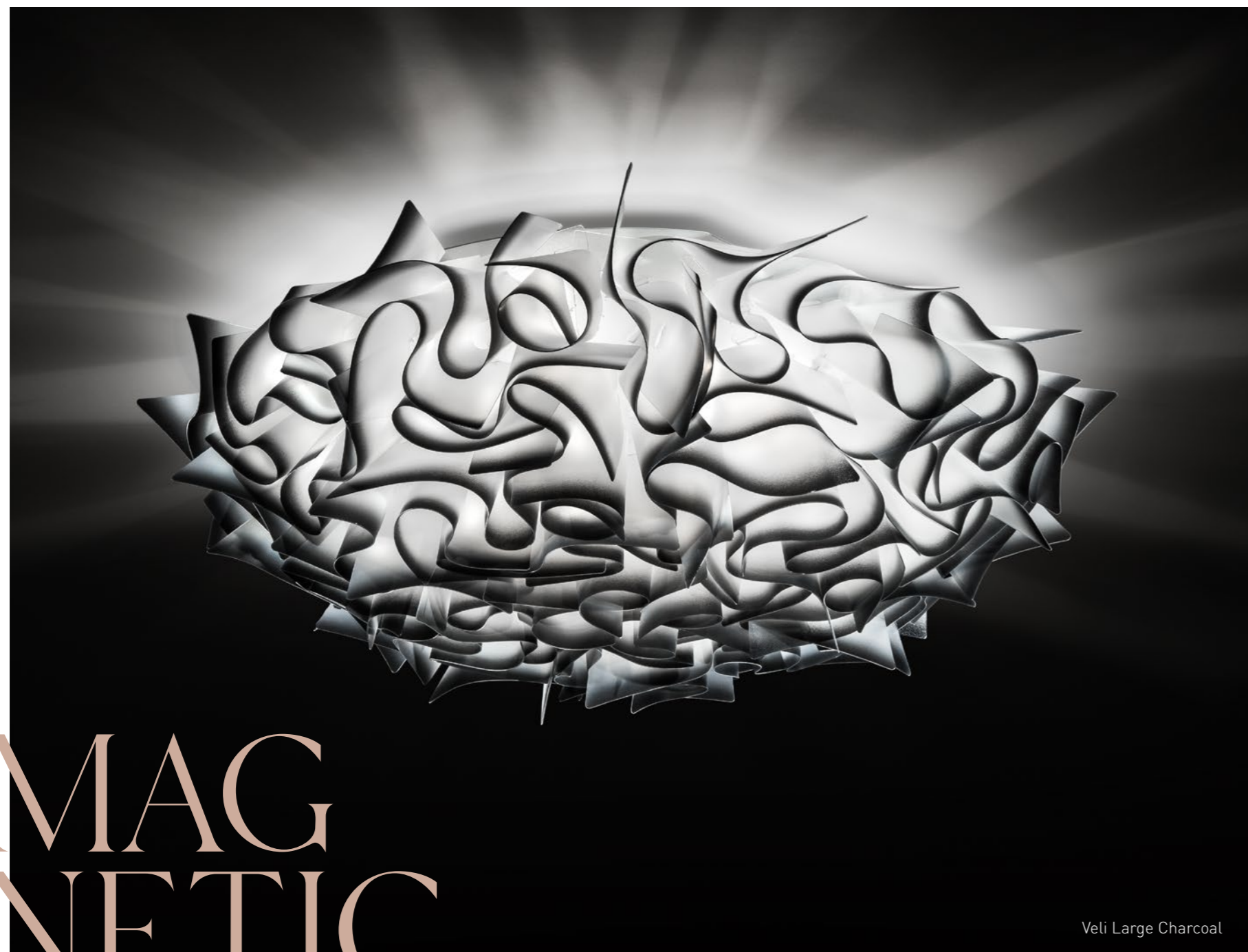

Veli Large Charcoal

MAGNETIC SYSTEM

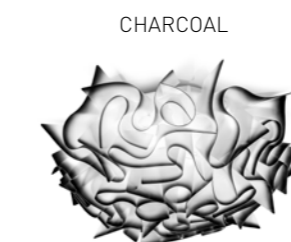
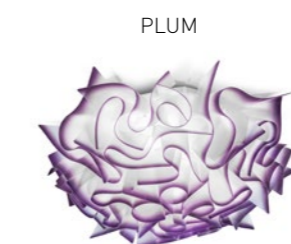
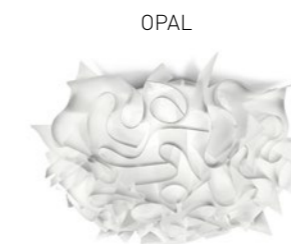

AESTHETICS MEET LUSH, DECORATIVE DETAILS

A series of handcrafted elements delicately connect to create sinuous, elegant design. Veli's selection of colours and versions add versatile richness to diverse interiors.

Tramite un sistema di incastrati eseguiti a mano, Veli si articola in un design sinuoso ed elegante capace di valorizzare ogni interior.

clizia

MAMA NON MAMA

BY ADRIANO RACHELE

technical details p. 524



Available in 3 sizes.
Disponibile in 3 misure.

L: Ø78 x h.25 cm - Ø30-3/4" x h.9-3/4"
M: Ø53 x h.20 cm - Ø20-3/4" x h.8"
Mini: Ø32 x h.15 cm - Ø12-1/2" x h.5-3/4"



MAGNETIC SYSTEM

CEILING LAMP

clizia PIXEL

BY ADRIANO RACHELE

technical details p. 524



Clizia Large Pixel

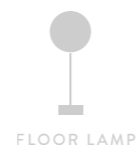

Clizia Large Pixel

Clizia is covered in pixels; a high-tech pattern meets soft tones that enhance the lamp's lush volume. A subtle dusting of white helps to evenly diffuse light without any glare.

Clizia si tinge di Pixel: una decorazione high-tech in tonalità tenui che si dipana sul volume rigoglioso della lampada. La spolverata di bianco all'interno del decoro contribuisce a diffondere uniformemente la luce e evitare l'abbagliamento.

clizia FUMÉ

BY ADRIANO RACHELE

technical details p. 524



Clizia Large Fumè

- 
 SUSPENSION
 p.152
- 
 WALL LAMP
 p.422
- 
 CEILING LAMP
- 
 TABLE LAMP
 p.344
- 
 FLOOR LAMP
 p.480



Slamp's original, decorative diffusers are assembled through a ritual established by both the designer and the woman bringing it to light. The process becomes mnemonic, fluid and enjoyable, much like arranging a bouquet.

La ritualità che dà origine ai diffusori decorativi e originali di Slamp viene collaudata dai designer insieme alle Sarte della Luce, per rendere mnemonico il processo e renderlo fluido e piacevole, come comporre un bouquet di fiori.

clizia

BY ADRIANO RACHELE



SUSPENSION
p.156

WALL LAMP
p.424

CEILING LAMP

TABLE LAMP
p.348

FLOOR LAMP
p.480

technical details p. 524

Lighting / Illuminazione:

Large: 3 x 12W E27/ E26 LED Filament Bulbs;

Medium 2 x 12W E27 /E26 LED Filament Bulbs;

Mini: 2 x 6W E14/E12 LED Filament Bulbs



hanami

BY ADRIANO RACHELE

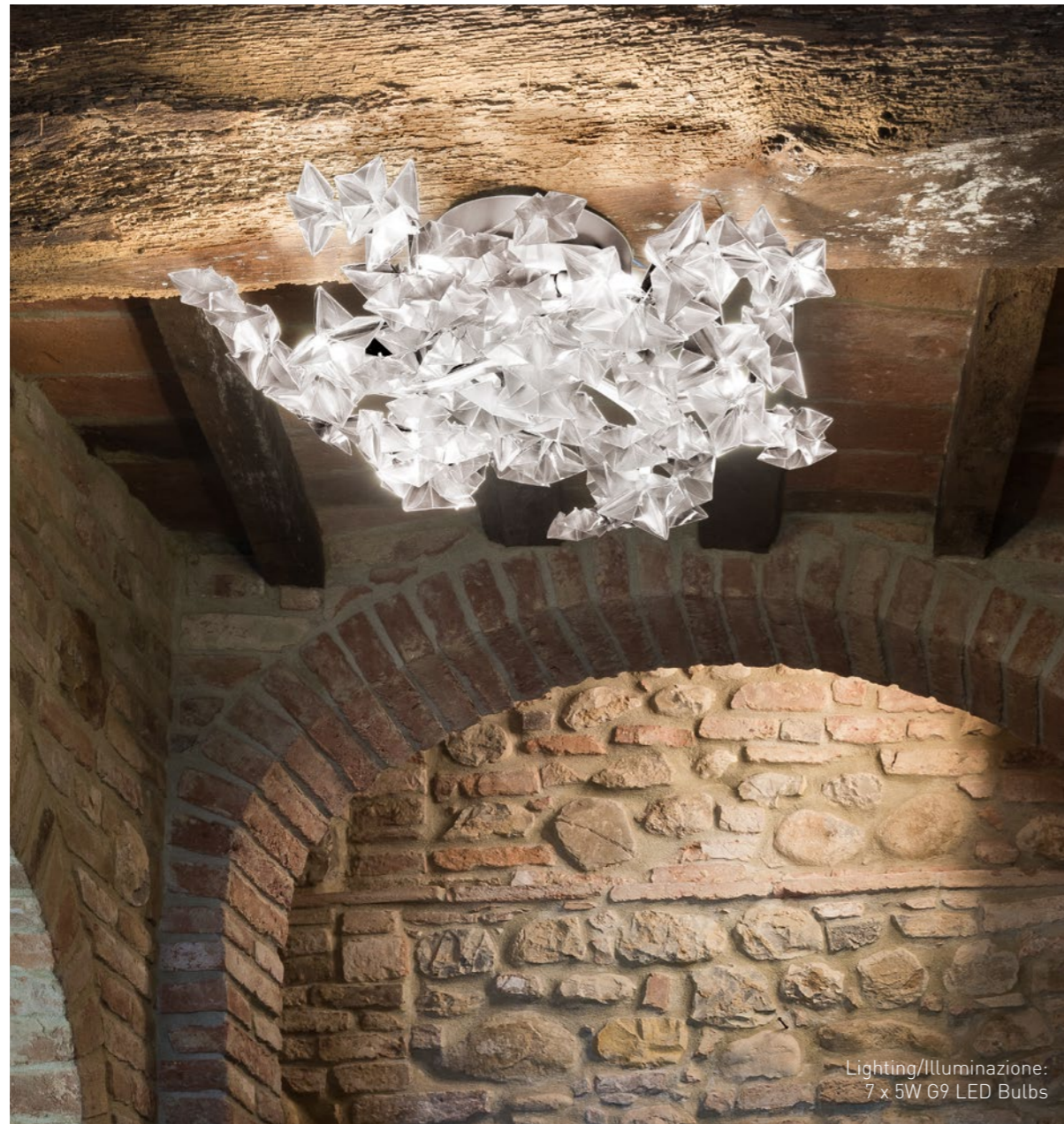

Lighting/Illuminazione:
7 x 5W G9 LED Bulbs



SUSPENSION
p.200



WALL LAMP
p.412



CEILING LAMP



TABLE LAMP



FLOOR LAMP



HAND
MADE
FOLDING

Every flower is made with 15
handmade folds.

Sono necessarie 15 piegature
manuali per realizzare ciascun fiore.

la belle étoile

BY ADRIANO RACHELE

technical details p. 536



The unbreakable yet almost weightless lamp is completely handcrafted in Slamp's atelier, with a soft, luminous LED source that can be dimmed.

La lampada, infrangibile, leggera, realizzata interamente a mano nell'atelier di Slamp, è dotata di una sorgente a LED sostituibile e dimmerabile.

La Belle Étoile White

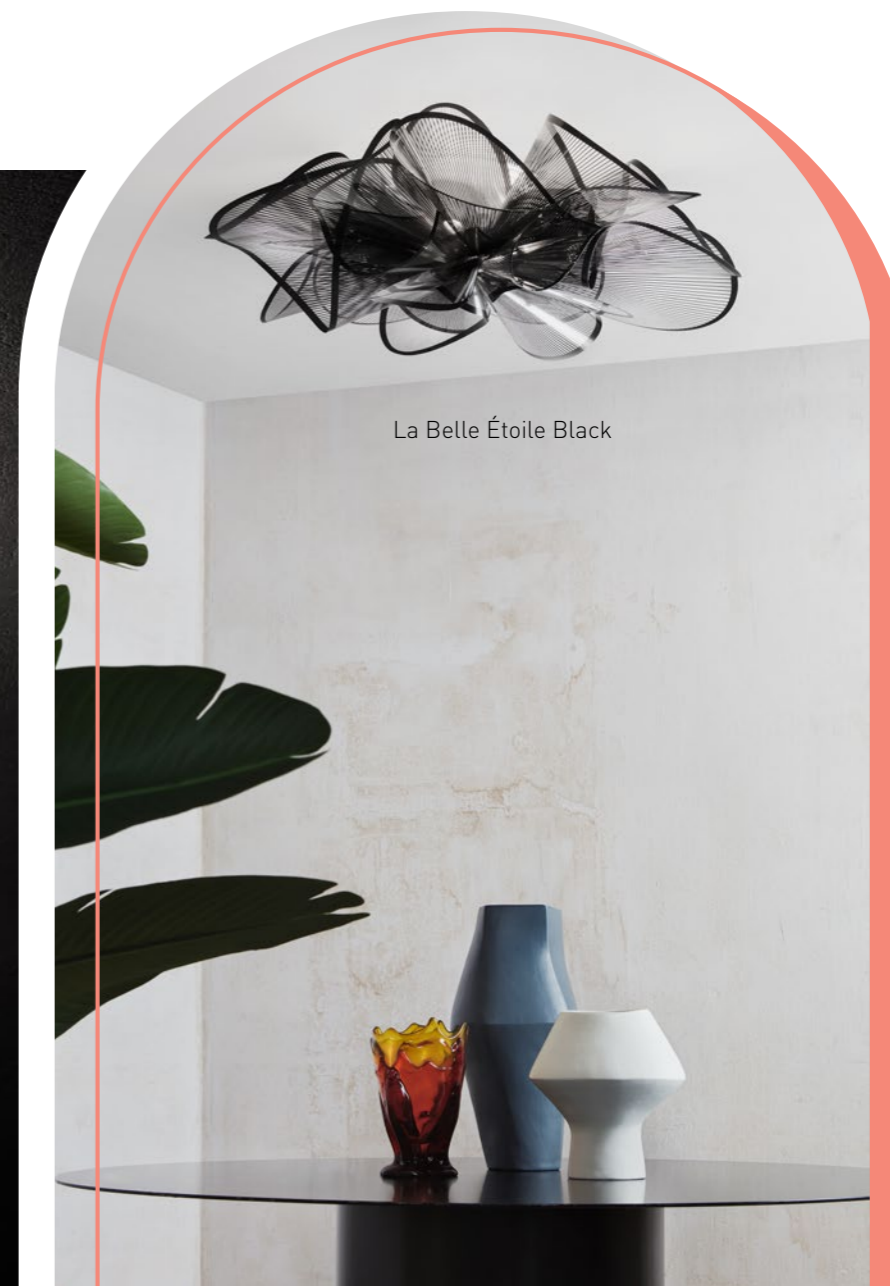

La Belle Étoile Black

Size/Dimensione:
Ø73 x h. 23 cm - Ø 21" x 8-3/4"



SUSPENSION
p.172



WALL LAMP
p.436



CEILING LAMP



TABLE LAMP

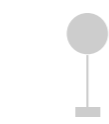

FLOOR LAMP

étoile

BY ADRIANO RACHELE

technical details p. 528



FLUID
ITY
OF LENTIFLEX®

CEILING LAMP

Size/Dimensione:
Ø73 x h. 23 cm - Ø21" x 8-3/4"

SUSPENSION
p.180

WALL LAMP
p.438

CEILING LAMP

TABLE LAMP

FLOOR LAMP

drusa

BY ADRIANO RACHELE

technical details p. 528



Size / Dimensioni:
Ø60 cm x 20 cm - Ø23-1/2" x h. 8"
Lighting / illuminazione: 4 x 12W E27/E26 LED Filament Bulbs

Drusa Velvet



Drusa White

Drusa Velvet is made of printed Lentiflex®, making every iridescent, silky piece unique.

La stampa di Drusa Velvet è realizzata su Lentiflex® e rende ogni prodotto unico, con una cromia iridescente e setosa.



PLAY VIDEO

CEILING LAMP



SUSPENSION
p.212



WALL LAMP
p.440



CEILING LAMP



TABLE LAMP



FLOOR LAMP

fabula

BY COSTANTINO MOROSIN

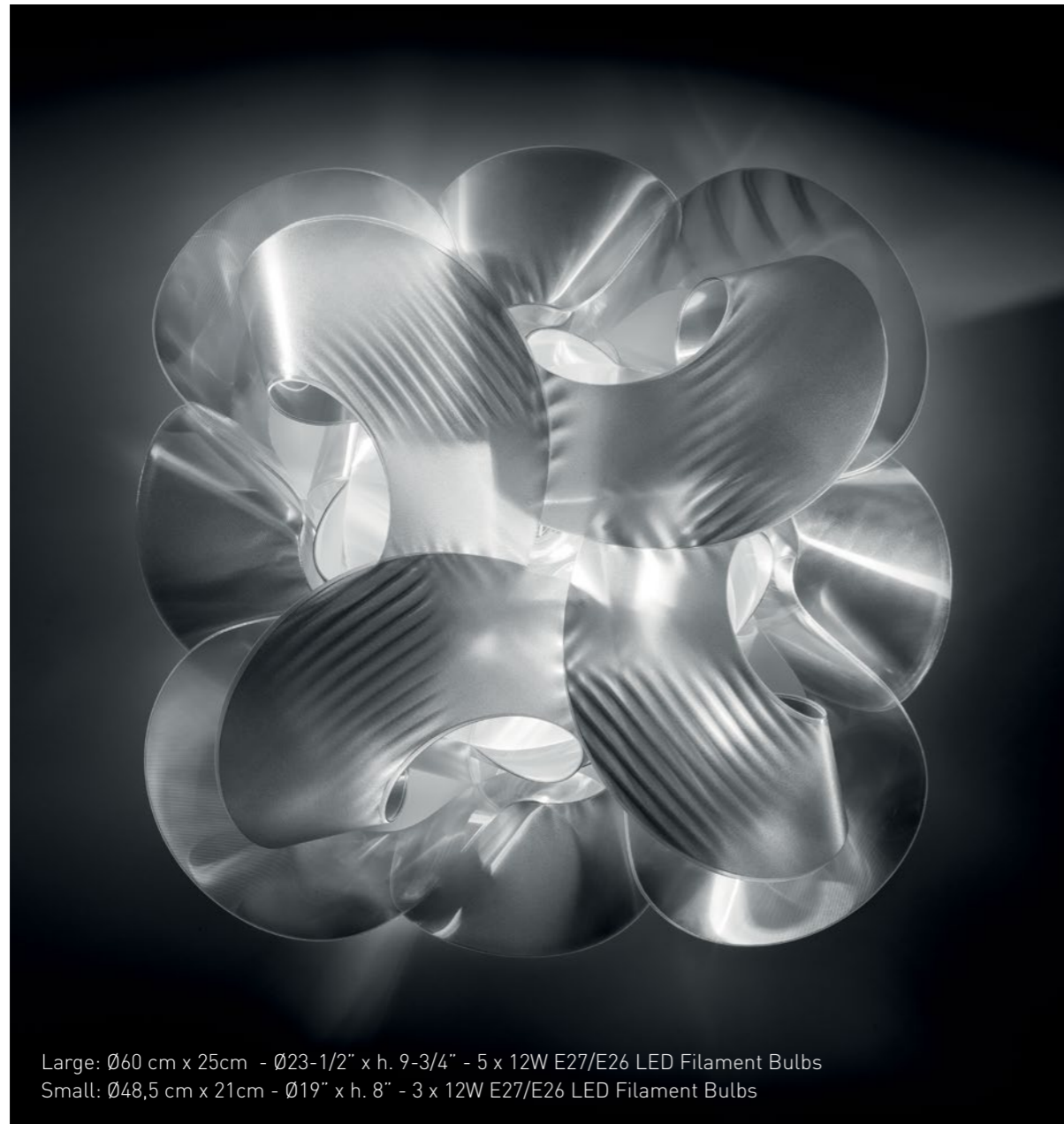

Large: Ø60 cm x 25cm - Ø23-1/2" x h. 9-3/4" - 5 x 12W E27/E26 LED Filament Bulbs
Small: Ø48,5 cm x 21cm - Ø19" x h. 8" - 3 x 12W E27/E26 LED Filament Bulbs



SUSPENSION
p.208



WALL LAMP
p.450



CEILING LAMP



TABLE LAMP



FLOOR LAMP

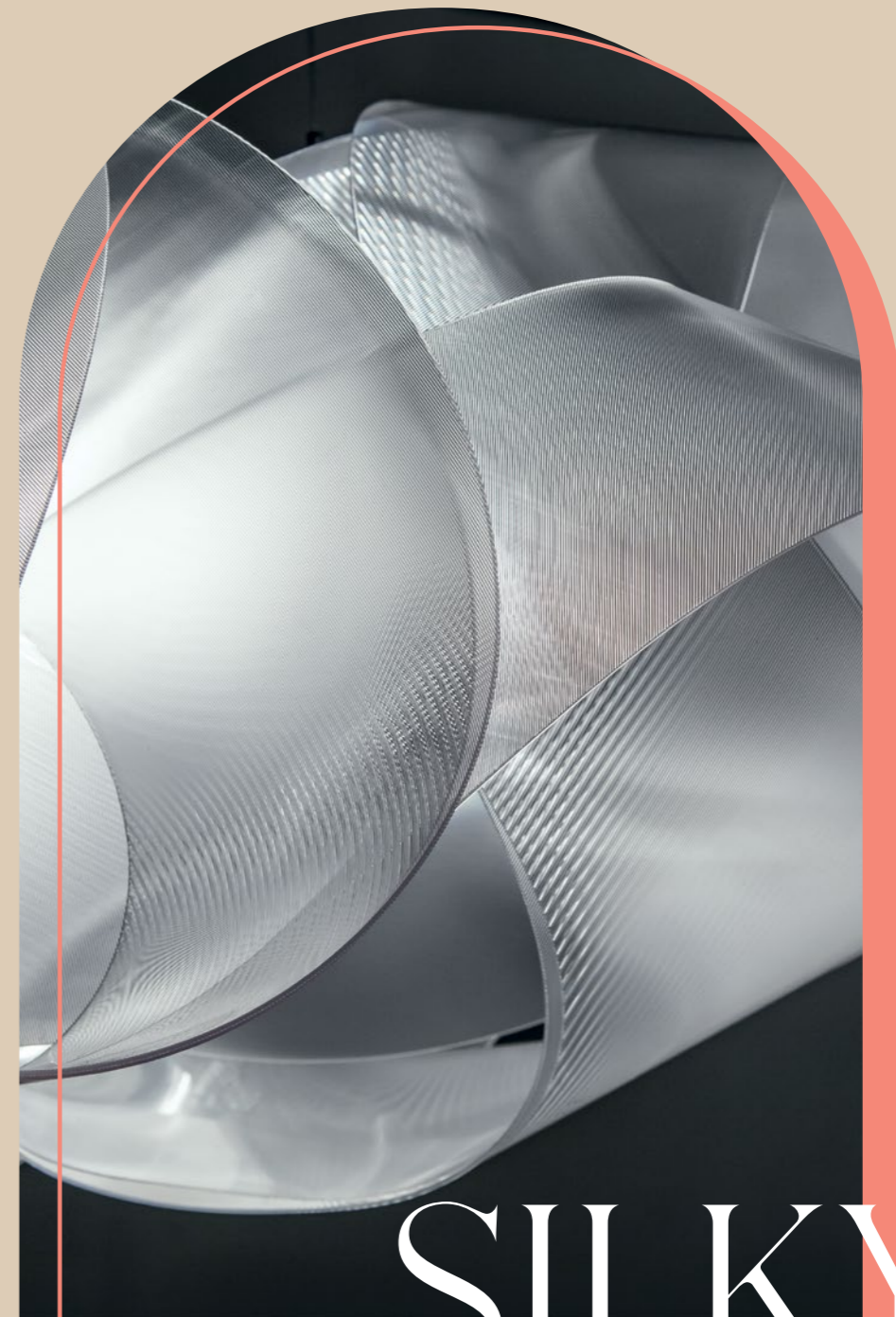

SILKY

FABRIC

bios

BY NIGEL COATES



Available in 3 dimensions / Disponibile in 3 dimensioni:
Large: Ø72 x h. 15 cm - Ø28-1/4" x h. 6"
Medium: Ø54 x h. 12 cm - Ø21-1/4" x h. 4-3/4"
Small: Ø36 x h. 8,5 cm - Ø14-1/4" x h. 3-1/4"



SUSPENSION



WALL LAMP
p.444



CEILING LAMP
p.300



TABLE LAMP
p.382

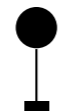

FLOOR LAMP
p.492



SUGGESTIVE
SHAD
DOWS

aurora

BY NIGEL COATES



Aurora Large White



SUSPENSION



WALL LAMP



CEILING LAMP



TABLE LAMP



FLOOR LAMP



Aurora Large Black

Core covered in Schöler crystals.
Available in 2 sizes.

Struttura centrale con cristalli
Schöler. Disponibile in 2 misure.

dafne

BY NIGEL COATES





SUSPENSION
p.240

WALL LAMP
p.446

CEILING LAMP
p.304

TABLE LAMP
p.384

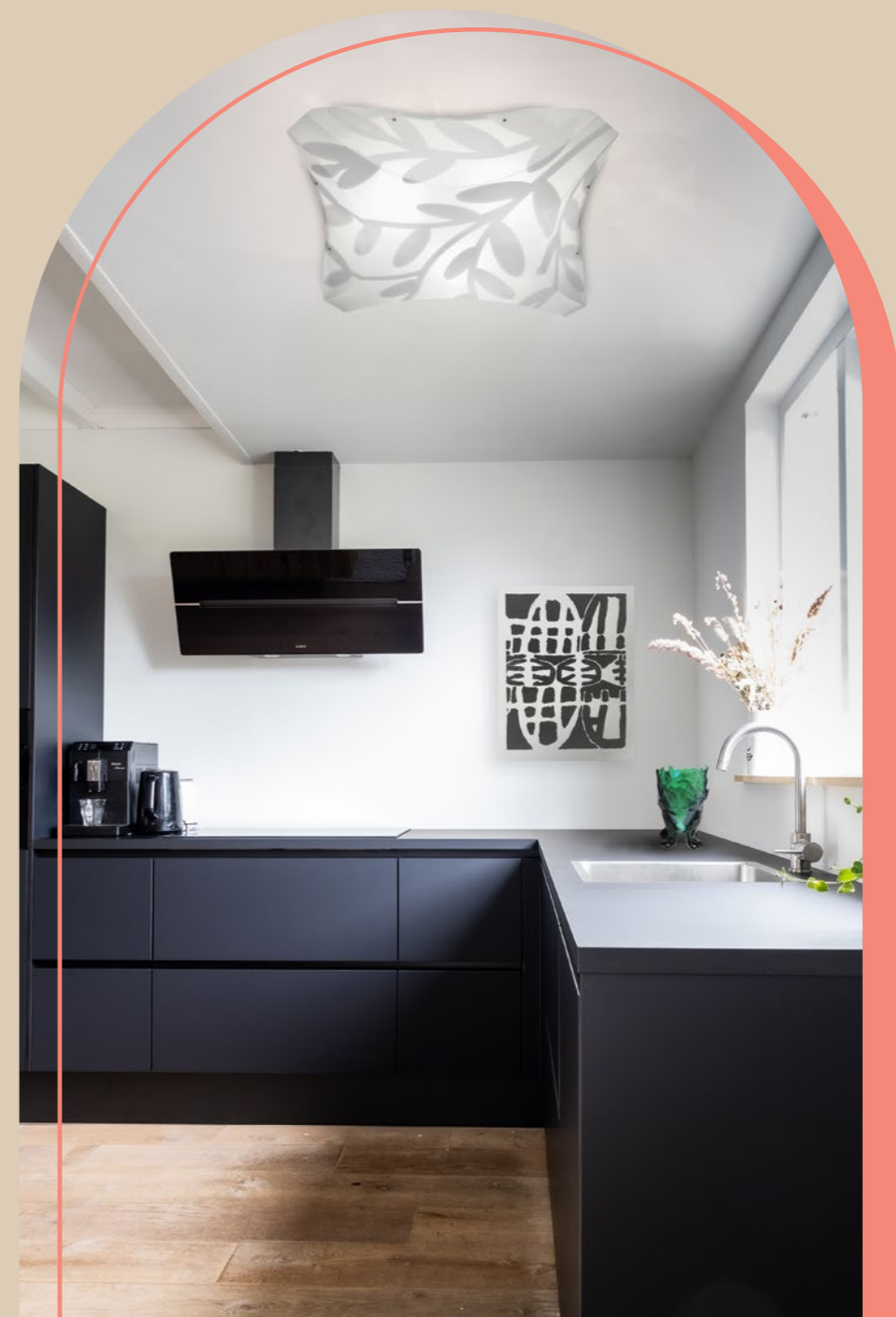
FLOOR LAMP
p.494



A nymph transformed into a tree: the myth and images that inspired the name.
Il nome della lampada porta con sé l'immaginario mitico della trasformazione della Ninfa da donna in arbusto.

alessandro mendini

“L'ARREDAMENTO DIVENTA
IL TEATRO DELLA VITA PRIVATA”

SLAMP:



venti

BY ALESSANDRO MENDINI



SUSPENSION



WALL LAMP
p.456



CEILING LAMP
p.308



TABLE LAMP
p.378

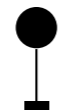

FLOOR LAMP
p.502



Available in 3 dimensions / Disponibile in 3 dimensioni:
Large: Ø72 x h. 15 cm - 28-1/4" x h. 6" ; Medium: Ø54 x h. 12 cm - 21-1/4" x h. 4-3/4"
Small: Ø36 x h. 8,5 cm - 14-1/4" x h. 3-1/4"

table lamps

BAUDELAIRE WROTE THAT THE WORLD IS LIMITLESS
WHEN LIT BY LAMPS. WE ADD, "AND HOW MANY
STORIES THEY TELL TO THOSE WILLING TO LISTEN"
THEY SEE US LAUGH, CRY, LOVE, SPEAK...THEY
ACCOMPANY US IN SILENCE AS WE CLOSE OUR
EYES AND SLIP INTO THE DREAMWORLD.

"COM'È GRANDE IL MONDO ALLA LUCE DELLE
LAMPADRE" SCRIVEVA BAUDELAIRE. "E QUANTE STORIE
RACCONTANO A CHI HA ORECCHIE PER ASCOLTARLE",
AGGIUNGEREMMO. CI GUARDANO RIDERE,
PIANGERE, AMARE, PARLARE...CI ACCOMPAGNANO
IN SILENZIO QUANDO, APPENA SOCCHIUSI GLI
OCCHI, CI LASCIAMO ANDARE
ALL'ABBRACCIO

SLAMP:

accordéon BATTERY

BY MARC SADLER

technical details p. 514



- 
 SUSPENSION
 p.124
- 
 WALL LAMP
- 
 CEILING LAMP
- 
 TABLE LAMP
- 
 FLOOR LAMP



What appears to be pleated, weightless fabric is actually undulating Lentiflex®, lit by a dimmable LED from within, resting on an anodized aluminum stem.

Quella che ricorda una fascia di tessuto impalpabile e plissettato è in realtà una struttura in Lentiflex® ondulato, illuminata dall'interno da una fonte luminosa LED dimmerabile e sorretta da un grazioso stelo in alluminio anodizzato.



Battery:
at max. intensity around 6.5 hours duration,
at min. intensity around 60 hours duration.

Batteria:
al massimo dell'intensità durata di 6.5 ore,
al minimo dell'intensità 60 ore di durata

BATTERY
POWERED



SIMULTANEOUSLY CHARGE 20
ACCORDÉON WITH THE USB
CHARGING STATION
(IDEAL FOR HO.RE.CA)



Accordéon is hand folded, formed, and draped from Slamp's unique materials, much like textiles, to clothe the illumination beneath.
Accordéon è realizzata scaldando il materiale unico di Slamp e drappeggiandolo a mano come fosse un tessuto.



HAND
MOLDED

TABLE LAMP

accordéon

BY MARC SADLER

technical details p. 514

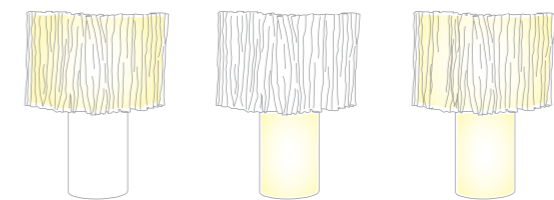

SHADE ON

BASE ON

SHADE AND BASE ON



SUSPENSION
p.124



WALL LAMP



CEILING LAMP



TABLE LAMP

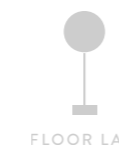

FLOOR LAMP



Slamp's artisans have handcrafted each unique diffuser, which can easily be removed for cleaning and maintenance. Dual lighting in the main source and base allows for either individual or collective illumination. The base features a steel plate proudly authenticating "Handmade in Italy".

Il diffusore - rimovibile per una facile pulizia - è scaldato e modellato a mano dalle Sarte della Luce per creare pezzi unici mai identici tra loro. La doppia accensione permette di tenere accesi diffusore e base sia singolarmente che contemporaneamente. La barretta in acciaio al lato della base riporta la dicitura "Handmade in Italy".



archiproducts
DESIGN AWARDS
—
WINNER 2020



Size / Dimensione: Ø37 x h. 48 cm - Ø14-1/2" x h. 18-3/4"

Lighting / Illuminazione: 2 x 12W E27 /E26 LED bulbs in the shade + an independent E14 /E12 in the base. 2 lampadine da 12W E27 /E26 LED nel diffusore e una E14 /E12 nella base con accensione indipendente.

marcantonio

“A LIGHTBULB IS
A LIVING ESSENCE”

SLAMP:



MARCANTONIO

idea

BY MARCANTONIO



THE
ESSENCE
OF LIGHT



SUSPENSION



WALL LAMP
p.406



CEILING LAMP



TABLE LAMP



FLOOR LAMP

technical details p. 535



Lighting / Illuminazione: 1 x 5W G9 LED Bulb

TABLE LAMP



Size / Dimensioni: Ø15 x h. 45,5 cm
Ø5-3/4" x h. 17-3/4"

By removing everything structural and decorative, what remains is the distillation of light: a lightbulb with a golden base, "magically" suspended on a brass arm. The G9 light source is easily changed by simply unscrewing it from the base.

Eliminato tutto ciò che in un corpo luminoso è un surplus di elementi decorativi, ciò che ne rimane è la vera essenza della luce: una lampadina con virola dorata "magicamente" sospesa su un'asta di ottone spazzolato. La fonte luminosa G9 all'interno della virola è svitabile per essere sostituita agevolmente.

The bulb angle can differ from lamp to lamp and is not predetermined.

L'inclinazione del bulbo sull'asta potrebbe differire tra un pezzo e l'altro e non è predeterminabile.

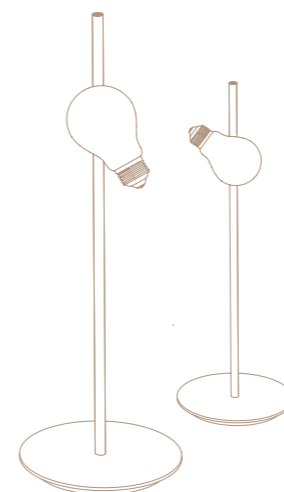

lafleur

BY MARC SADLER



- SUSPENSION
- WALL LAMP
p.400
- CEILING LAMP
- TABLE LAMP
- FLOOR LAMP



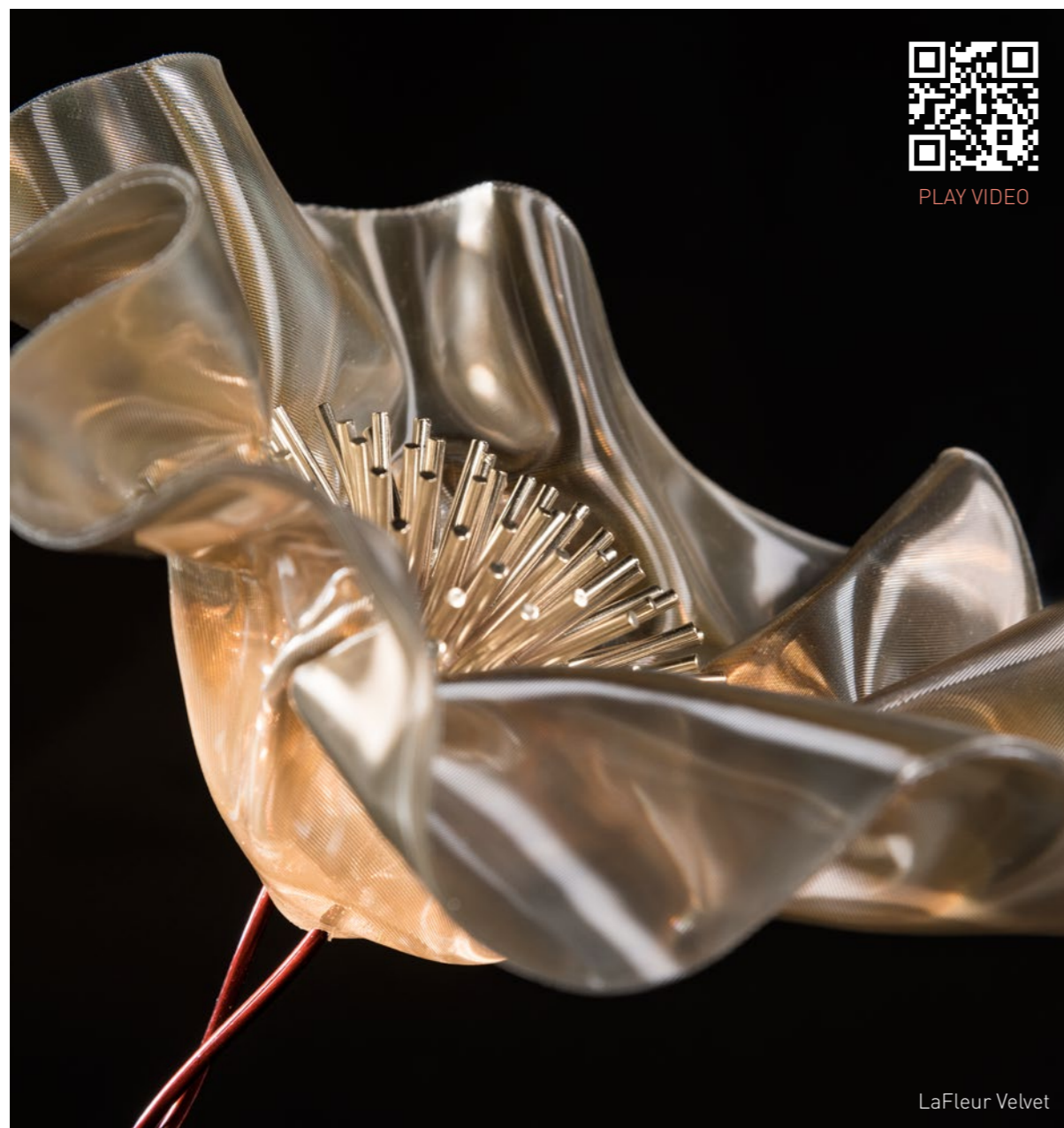

LaFleur is a delicate, rechargeable table lamp, made with thermoformed Lentiflex® and molded by hand to create a soft, poetic crown. The flower's pistils help dissipate the LED warmth.

LaFleur è una delicata lampada da tavolo con batteria ricaricabile, realizzata riscaldando il Lentiflex® e modellandolo con le mani fino a creare una corolla morbida e poetica. Il pistillo del fiore ha la funzione di dissipare il calore dei LED.



BATTERY
POWERED

TABLE LAMP

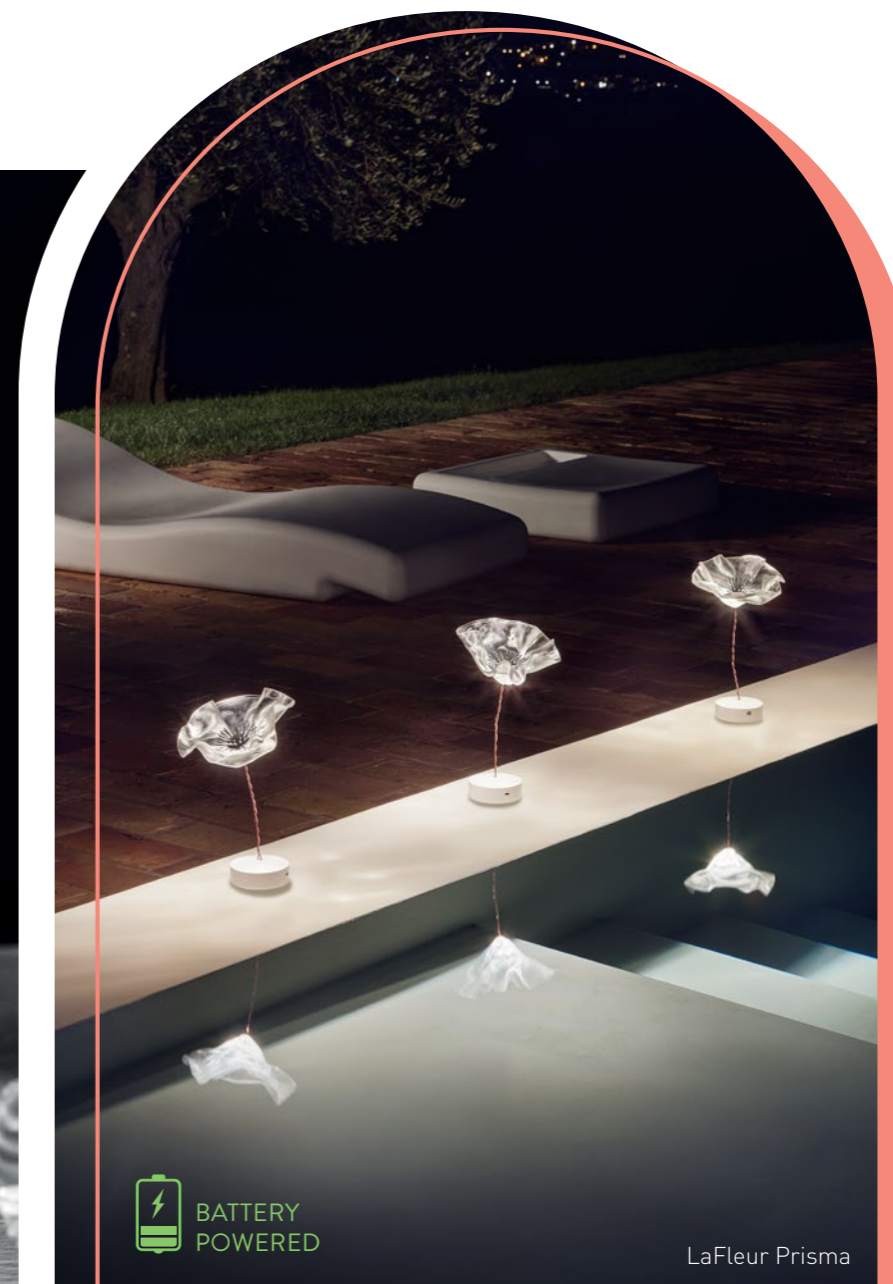

BATTERY
POWERED

LaFleur Prisma

SIMULTANEOUSLY CHARGE
20 LAFLEUR WITH THE USB
CHARGING STATION
(IDEAL FOR HO.RE.CA)

TABLE LAMP



The lamp has a magnetic base that will adhere to any metal surface. It also comes with a complimentary metal anchor for non-metal surfaces, perfect to go under the tablecloth, for example, for a mise-en-place, or for the wall to turn LaFleur into an appliqué.

La lampada ha una base magnetica per essere ancorata a tutte le superfici di metallo. Viene fornito in combo anche un disco complementare che può essere celato sotto la tovaglia di una mise-en-place o avvitato al muro per trasformare velocemente LaFleur in una applique.



Soft touch dimmer system
Dimmerazione tramite sistema soft touch

atmosfera

BY LORENZA BOZZOLI

technical details p. 516



Atmosfera Medium Gold



Atmosfera Small Pewter

Atmosfera Medium Pewter

DUAL ILLUMINATION BASE AND SHADE

Size / Dimensioni: Medium Ø30 x h. 44,5 cm (Ø11-3/4 x h. 17-1/4")
Small: Ø20 x h. 29,5 cm (Ø7-3/4 x h. 11-1/2")

-  SUSPENSION
p.142
-  WALL LAMP
-  CEILING LAMP
-  TABLE LAMP
-  FLOOR LAMP



Atmosfera is a 44 or 30 cm tall lamp with a hand-polished sphere and Pewterflex® or Goldflex® base. The technopolymers are perforated to reveal the sandblasted layer underneath; the light source within shines through, creating polkadots. The base and diffuser switches are independent.

Atmosfera è una lampada da 44 o 30 cm di altezza composta da una sfera satinata a mano e una base in Pewterflex® o Goldflex®. Questi materiali sono forati lasciando vedere lo strato più interno sabbiato che permette alla luce celata nella base di fuoriuscire disegnando dei pois. Doppia accensione indipendente di diffusore e base.



Lighting / Illuminazione:
 Medium: 2 x12W E27/E26
 LED Filament bulbs
 Small: 2 x 6W G9 LED
 Hand-finished Sphere.
 Sfera satinata a mano.

moon 25TH ANNIVERSARY

BY SLAMP CREATIVE DEPARTMENT

technical details p. 541



Size / Dimensioni: 30 x 14 x h 57cm - 11-3/4" x 5-1/2" x h. 22-1/4"

Brushed brass sides. Printed marble texture facade.
Profili in ottone spazzolato. Texture effetto marmo stampata sul fronte.



clizia

BATTERY MAMA NON MAMA
BY ADRIANO RACHELE



Size / Dimensione:
Ø27 x h. 25 cm - Ø10-3/4" x h. 9 -3/4"

Lighting / Illuminazione:
1.3W dimmable - 150Lumen
2700 Kelvin - Rechargeable battery

SUSPENSION
p.146

WALL LAMP
p.418

CEILING LAMP
p.282

TABLE LAMP

FLOOR LAMP

technical details p. 525



Soft touch dimmer system
Dimmerazione tramite sistema soft touch



clizia

BATTERY FUMÉ
BY ADRIANO RACHELE

technical details p. 525



SIMULTANEOUSLY CHARGE
20 CLIZIA WITH THE USB CHARGING
STATION (IDEAL FOR HO.RE.CA)



Brightness intensity can be regulated using the soft touch system.
The battery duration lasts around 6.5 hours at full brightness,
and up to 60 at minimum brightness.

Regolazione intensità luminosa tramite sistema touch a sfioramento -durata
della batteria di 6,5 ore al massimo della potenza e intorno
alle 60 ore al minimo d'intensità

- 
 SUSPENSION
p.152
- 
 WALL LAMP
p.422
- 
 CEILING LAMP
p.286
- 
 TABLE LAMP
- 
 FLOOR LAMP
p.480



From warmer months al fresco to a luxurious indoor bloom.
Al termine della bella stagione rimane con te, come un prezioso complemento d'arredo.



BATTERY
POWERED

TABLE LAMP

clizia

BY ADRIANO RACHELE



WHITE

ORANGE

PURPLE

BLACK

SUSPENSION
p.156

WALL LAMP
p.424

CEILING LAMP
p.288

TABLE LAMP

FLOOR LAMP
p.480



Clizia has discrete elegance that refreshes any space.
Available in 4 vivacious colours and a sophisticated fumè version.

Clizia ravviva gli ambienti con discreta eleganza.
Disponibile in 4 colori briosi più la sofisticata versione Fumè.

liza PRISMA

BY ELISA GIOVANNONI

technical details p. 540



Size / Dimensioni:
Ø35 cm x h. 70 cm - Ø13" x h. 27"



liza PEWTER

BY ELISA GIOVANNONI

technical details p. 540



TABLE LAMP

A baroque-inspired masterpiece that unites tradition with haute design, using Stamp's technopolymers; the dual illumination includes a E27/E26 LED bulb in the main diffusor and a courtesy G9 LED bulb in the base, and each can be used independently.

Masterpiece d'ispirazione barocca che unisce un design dal sapore tradizionale all'uso dei tecnopolimeri di Stamp. Dotata di un sistema di doppia illuminazione: lampadina G9 LED di cortesia nella base e lampadina E27/E26 nel cappello, con accensione indipendente.

- 
 SUSPENSION
 p.236
- 
 WALL LAMP
- 
 CEILING LAMP
- 
 TABLE LAMP
- 
 FLOOR LAMP

analogia project

“LIGHT GIVES LIFE
TO THINGS”

SLAMP:



overlay

BY ANALOGIA PROJECT



-  SUSPENSION
-  WALL LAMP
-  CEILING LAMP
-  TABLE LAMP
-  FLOOR LAMP



THE PER FECT WRITING LAMP

TABLE LAMP



OVERLAY AND MONTBLANC
MEISTERSTÜCK SET

Sold together in an elegant, personalized case.
Choose between fountain or ballpoint writing instruments.

Vendute in combinata in un cofanetto personalizzato
Due versioni: stilografica e penna a sfera

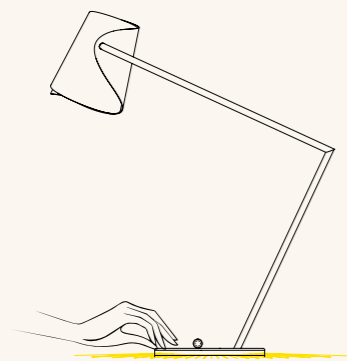

The sensitive touch system turns on the LED
courtesy light in the brass base.
Il pulsante a sfioramento accende la luce LED
di cortesia nella base in ottone.

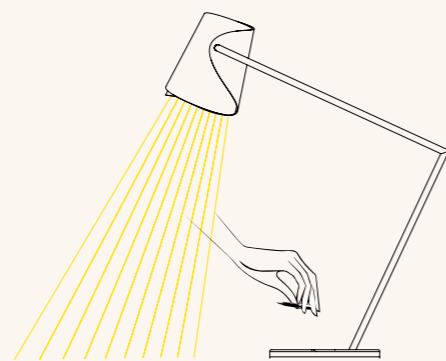

Lifting the writing instrument from the leather rest
turns on the main LED light in the Copperflex® shade..
Sollevando lo strumento da scrittura dall'alloggio in pelle,
si accende la luce LED nel diffusore in Copperflex®

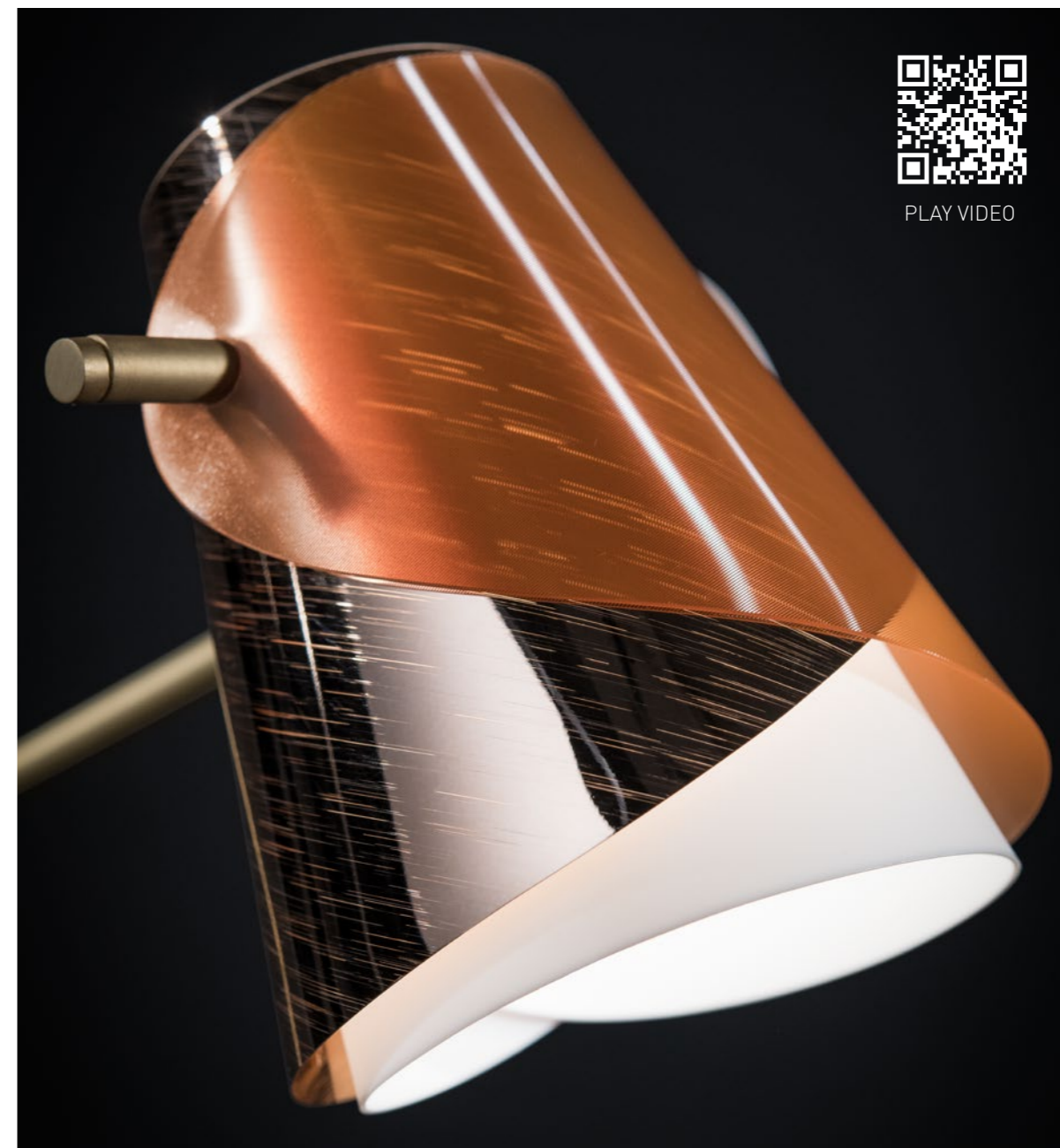

PLAY VIDEO

The best gift to give passionate writers is the freedom to create without having to do anything else, without interrupting their inspirational flow: lift the pen and begin. Overlay was born of this concept. The perfect writing lamp's shade is illuminated the moment one lifts the Montblanc Meisterstück Le Grand, included with the lamp. The only thing left to do is choose is the type of pen stroke.

Il più grande regalo che si può fare agli appassionati di scrittura è lasciare che, colti dall'ispirazione, non debbano pensare ad altro che a sollevare la penna e incidere per sempre sulla carta i loro pensieri. E così nasce Overlay, la perfetta lampada da scrittura, il cui diffusore si accende semplicemente sollevando la Montblanc Meisterstück Le Grand fornita in combinata con la lampada. Basta solo scegliere quale tratto di scrittura si preferisce.

veli FOLIAGE

BY ADRIANO RACHELE



SUSPENSION
p.182

WALL LAMP
p.426

CEILING LAMP
p.270

TABLE LAMP
p.360

FLOOR LAMP



Size / Dimensione:
Ø28 cm x h. 28 cm - Ø11" x h. 11"

Veli's diffusors comes to light with up to 268 hand inserted elements: no glue, no screws.
Il diffusori di Veli contano fino a 268 incastri manuali, senza colle o viti.

veli

BY ADRIANO RACHELE



Veli Table Couture



Veli Table Opal

HAND CRAFTED

technical details p. 547

-  SUSPENSION p.186
-  WALL LAMP p.428
-  CEILING LAMP p.272
-  TABLE LAMP
-  FLOOR LAMP

Size / Dimensione:
Ø32 cm x h. 25 cm - Ø12-1/2" x h. 8-3/4"
Integrated magnetic system. Dotata di attacco magnetico.

fiorellina

BY NIGEL COATES

technical details p. 531

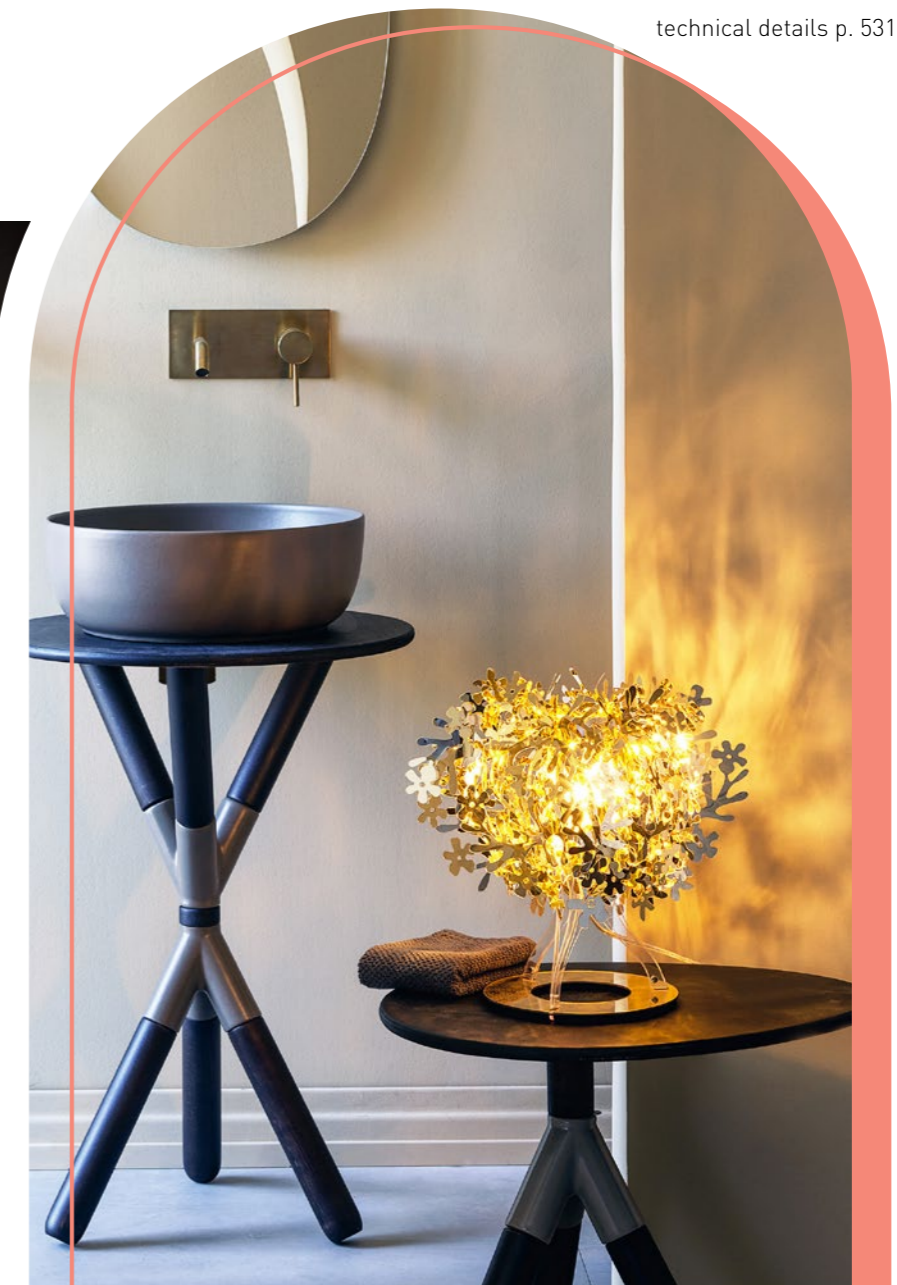

TABLE LAMP

Size / Dimensioni: Ø33 cm x h. 34 cm - Ø13" x h. 13"

Available in 3 metallized versions (Gold, Silver, Copper) and a White version - Disponibile in 3 versioni metallizzate (Gold, Silver, Copper) e una bianca.



SUSPENSION
p.226



WALL LAMP
p.448



CEILING LAMP



TABLE LAMP



FLOOR LAMP



WEL COMING

AND SUGGESTIVE



Expressive powers and fresh figurativism meet in a flurry of reflective, luminous petals.
La realtà dei piccoli cespugli arruffati di bosso incontra la magia del figurativismo.

bach

BY FRANCESCO PARETTI

technical details p. 519



Bach Gold



Bach White

Available in Gold and White.
Table (2 sizes) and floor (3 sizes)
versions available.

Disponibile in Gold e White.
2 misure da tavolo 3 da terra.



SUSPENSION



WALL LAMP



CEILING LAMP



TABLE LAMP



FLOOR LAMP
p.476

cactus

BY ADRIANO RACHELE



Cactus Gold

SUSPENSION
p.216

WALL LAMP

CEILING LAMP

TABLE LAMP

FLOOR LAMP
p.482

technical details p. 521

Constructed using a hand folded system. This page: XM and XS Prisma version. Previous: Cactus Small Gold.

Sistema di incastrati eseguito a mano. In questa pagina la versione Prisma XM e XS. Nella pagina precedente la versione Small Gold



Cactus Prisma

TABLE LAMP

gemmy

BY RAGNISCO, SPALLETTA, CROCE, WIJFFELS

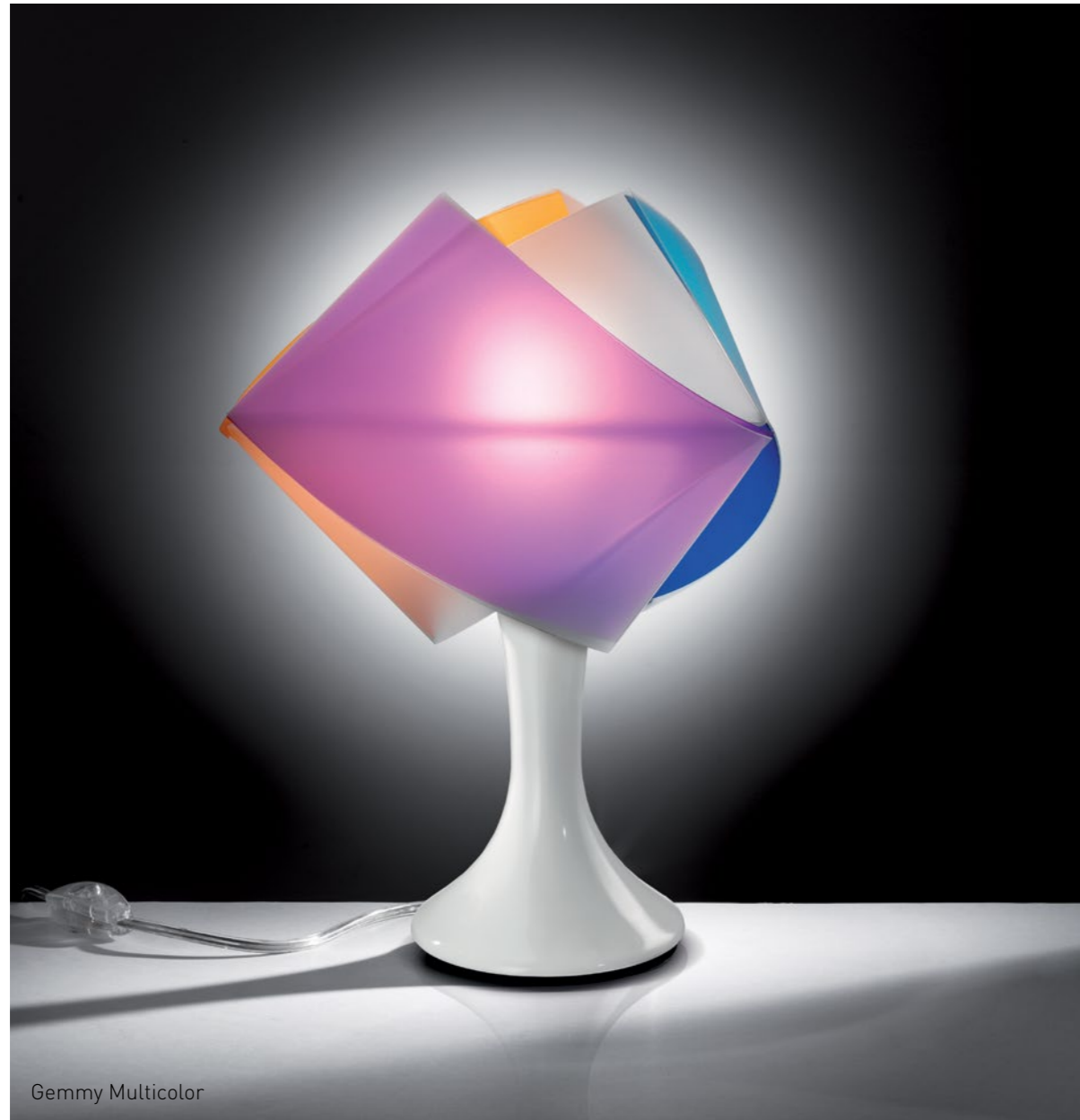



SUSPENSION
p.240

WALL LAMP

CEILING LAMP

TABLE LAMP

FLOOR LAMP



POLY EDRICH FACETS

Gemmy Arlecchino

gemmy PRISMA

BY RAGNISCO, SPALLETTA, CROCE, WIJFFELS

technical details p. 532



TABLE LAMP

Size / Dimensioni:
 Ø22 cm x h. 33 cm - Ø8-3/4" x h. 13"
 White steel base. Base in acciaio bianco verniciato

- 
 SUSPENSION
 p.238
- 
 WALL LAMP
- 
 CEILING LAMP
- 
 TABLE LAMP
- 
 FLOOR LAMP

diamond

BY PAOLUCCI, STATERA

technical details p. 527



INSPIRED BY
BRAN
CUSI

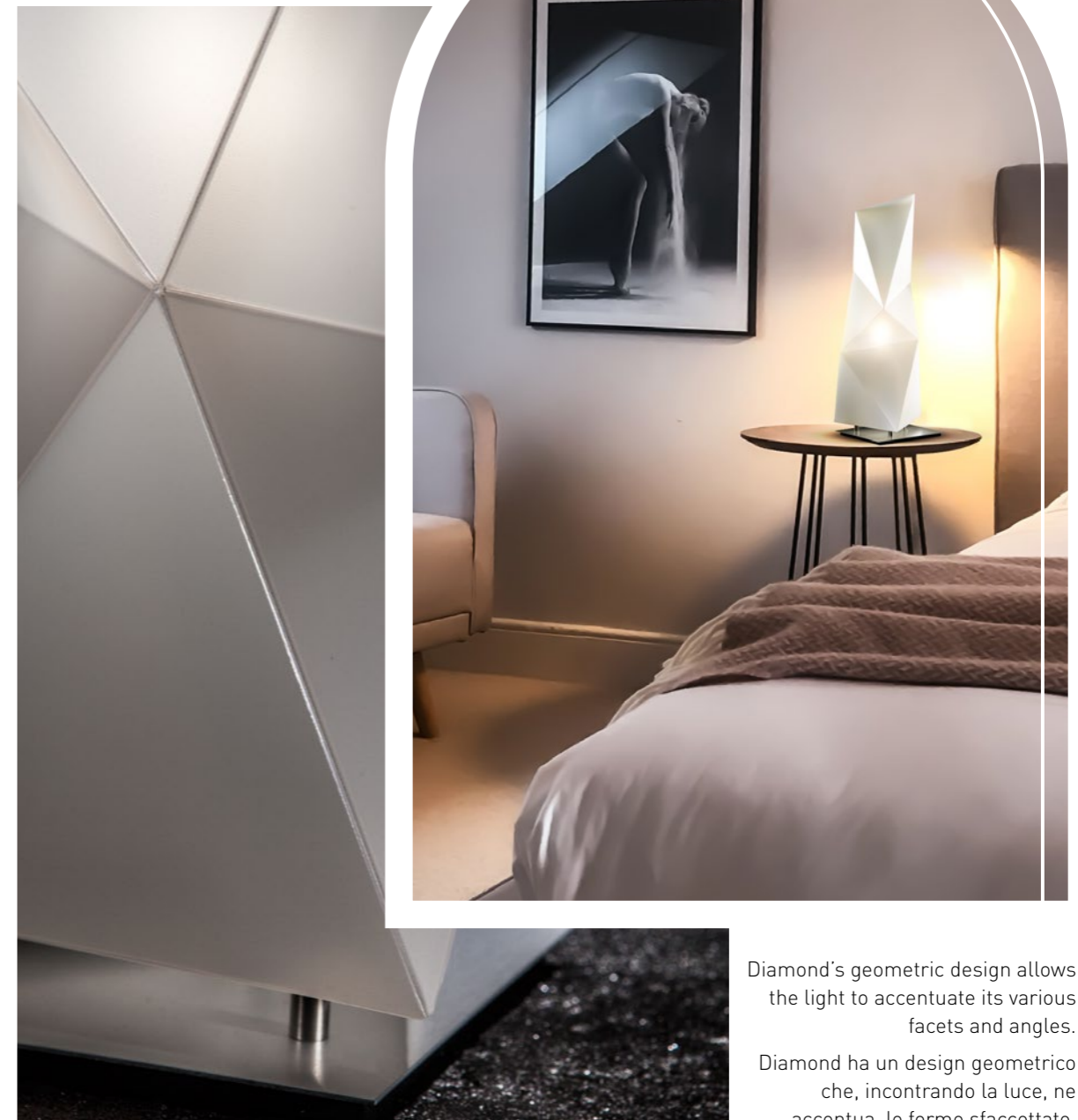

TABLE LAMP

Diamond's geometric design allows the light to accentuate its various facets and angles.

Diamond ha un design geometrico che, incontrando la luce, ne accentua le forme sfaccettate.

-  SUSPENSION
 -  WALL LAMP
 -  CEILING LAMP
 -  TABLE LAMP
 -  FLOOR LAMP
- p. 498

venti

BY ALESSANDRO MENDINI

technical details p. 549



TABLE LAMP

Size / Dimensioni:
21 cm x 10 cm h. 39 cm - 8 -1/4" x 3-3/4" x h. 15-1/4"
Lighting /Illuminazione: 1x 6W LED Filament Bulb E14/E12

-  SUSPENSION
-  WALL LAMP
p.456
-  CEILING LAMP
p.308
-  TABLE LAMP
p.378
-  FLOOR LAMP
p.502

las palmas

BY PAOLUCCI, STATERA

technical details p. 539



Size / Dimensione:
18 x 21 x h. 57,5 cm
8-1/2" x 7" x h. 22"

Polished steel sides and base.
Base e profili in acciaio lucido.



bios

BY NIGEL COATES



SUSPENSION

WALL LAMP
p.444

CEILING LAMP
p.300

TABLE LAMP

FLOOR LAMP
p.492



technical details p. 520

TABLE LAMP

2 sheets of Opalflex® are layered, creating suggestive plays of light.

Attraverso la sovrapposizione di 2 strati di Opalflex® la luce filtra e crea suggestivi giochi di luci e ombre.

dafne

BY NIGEL COATES

technical details p. 526



Size / Dimensioni:
21 cm x 10 cm h. 39 cm - 8 -1/4" x 3 -3/4" x h. 15-1/4"

-  SUSPENSION
p.240
-  WALL LAMP
p.446
-  CEILING LAMP
p.304
-  TABLE LAMP
-  FLOOR LAMP
p.494

The name conjures up the image of a mythical nymph turned tree, and the illumination is balanced and peaceful. The charming tone on tone decoration has been inspired by laurel leaves.

Il nome della lampada porta con sé l'immaginario mitico della trasformazione della Ninfa da donna in arbusto. Con la sua luce, genera una sensazione di pace ed equilibrio: il segreto del suo fascino sta nel delicato decoro tono su tono, ispirato alla pianta di alloro.



LAUREL
LEAVES

TABLE LAMP

wall lamps

GROTTESCHE, TAPESTRIES, TELAMONS...
A WALL CAN BE MORE THAN THAT, AND A
LIGHT CAN BE MORE THAN A LAMP.
TRANSFORMING A HALLWAY INTO A
THE PROLOGUE OF A NARRATIVE,
AND A LIVING ROOM AS ITS EPILOGUE
GIVES POETIC LICENSE TO THOSE
WHO WANT TO WRITE THEIR OWN UNIQUE
STORY EACH TIME THE LIGHTS ARE
SWITCHED ON.

GROTTESCHE, ARAZZI, TELAMONI...COME
UNA PARETE PUÒ ESSERE PIÙ DI UN MURO,
UNA LUCE PUÒ ESSERE PIÙ DI UNA LAMPADA.
TRASFORMARE UN CORRIDOIO NEL
PROLOGO DI UN RACCONTO E UN
SOGGIORNO NEL SUO EPILOGO È UNA LICENZA
POETICA CONCESSA A CHIUNQUE VOGLIA
SCRIVERE UNA STORIA INEDITA
A OGNI NUOVA ACCENSIONE.

SLAMP:

mida

BY ADRIANO RACHELE



Mida Multicolor Medium



SUSPENSION



WALL LAMP



CEILING LAMP
p.258



TABLE LAMP



FLOOR LAMP



technical details p. 541

Mida Rose Medium

WALL LAMP



Mida White/Gold Medium

Mida is a ceiling/wall lamp with our exclusive magnetic system for easy installation and maintenance, inspired by polished cabochon geometrically placed across a floral corolla with silky, iridescent stones.

Dotata di attacco magnetico per una facile installazione e semplice manutenzione, Mida si ispira ai cabochon lisci e levigati che si dispongono in maniera ordinata a disegnare la corolla di un fiore dai colori cangianti e setosi.



Mida White/Platinum Large

Available in 5 colours and 3 sizes (2 designs). Diffusor with magnetic hanging system. Disponibile in 5 colori e 3 misure (2 design alternativi). Diffusore dotato di attacco magnetico.

mida APPLIQUE

BY ADRIANO RACHELE



Mida Applique Multicolor



SUSPENSION



WALL LAMP
p.388



CEILING LAMP
p.258



TABLE LAMP



FLOOR LAMP

technical details p. 541

ROSE



AMBER



MULTICOLOR



WHITE / PLATINUM



WHITE / GOLD



Size / Dimensioni:

Ø32 cm x h. 12 cm - Ø12 -1/2" x h. 4-1/2"

4 coloured gems and 5 metallic gems / 4 gemme coloratee 5 metallizzate.

la vie

BY ADRIANO RACHELE



La Vie Medium White



SUSPENSION



WALL LAMP



CEILING LAMP
p.244



TABLE LAMP



FLOOR LAMP



THE
ESSENCE
OF EVERYTHING



La Vie White collection (L-M-Mini)



Diffusor with Magnetic System.
Diffusore dotato di attacco magnetico.

Size / Dimensioni:

Large: 71 x 74 x h. 21 cm - 27-3/4" x 29" x h. 8-1/4"

Medium: 47 x 50 x h. 19 cm - 19-1/2" x 18-1/4" x h. 7-1/2"

Mini: 34 x 36 x h. 15 cm - 13-1/4" x 14" x h. 5-3/4"



The ladies who tailor light quickly form a relationship with the product they specialise in, and this evolving know-how goes hand in hand with the pride and affection they feel for each piece produced.

Le Sarte della Luce acquisiscono una tale capacità di dialogare con il prodotto che già dopo poche settimane sentono una forte affezione nei confronti del modello di cui sono incaricate di seguire la manifattura.



technical details p. 538

La Vie Mini Amber

WALL LAMP

lafleur

BY MARC SADLER



LaFleur Velvet



SUSPENSION



WALL LAMP



CEILING LAMP



TABLE LAMP
p.328



FLOOR LAMP



technical details p. 539

WALL LAMP



Lighting/ Illuminazione: 1 x 3W G4 Dimmable LED Bulbs with Power Supply: 110~220Vac / 12 Vdc.



LaFleur Velvet detail

The G4 LED bulb can be dimmed with a Triac system, creating a soft glow.

La lampadina G4 LED, dimmerabile con sistema Triac, genera una morbida luce soffusa.

LaFleur Prisma



HAND
MOLDED



The stem is made of dual painted copper wires, designed to bend perfectly under the blossom.

Lo stelo, composto da 2 cavi in rame smaltato, segue la curva studiata dal designer, per conferire alla corolla diffusore l'inclinazione perfetta.

idea RECESSED WALL

BY MARCANTONIO



SUSPENSION



WALL LAMP
p.410



CEILING LAMP



TABLE LAMP
p.324



FLOOR LAMP



The recessed version can be placed within drywall for a floating effect.
Dimmable G9 LED bulbs make for easy substitution.

La versione Recessed può essere incassata per un effetto a scomparsa.
Lampadina G9 a LED dimmerabile e facilmente sostituibile.

technical details p. 535

WALL LAMP



idea APPLIQUE

BY MARCANTONIO



Mirrored Stainless Steel
Acciaio effetto specchio

- 
 SUSPENSION
- 
 WALL LAMP
 p.406
- 
 CEILING LAMP
- 
 TABLE LAMP
 p.324
- 
 FLOOR LAMP

INSPIRATION COMES LIKE A LIGHTBULB GOING OFF IN YOUR HEAD

They say inspiration comes like a lightbulb going off in your head. They also say good things come in small packages. Reinventing this universal archetype required genius, folly, and sartorial expertise.

Dicono che l'ispirazione si accenda all'improvviso come una lampadina sulla testa. Dicono anche che le cose migliori arrivano in pacchetti piccoli. Reinventare questi archetipi richiede una certa dose di geniale follia e di esperienza manifatturiera.

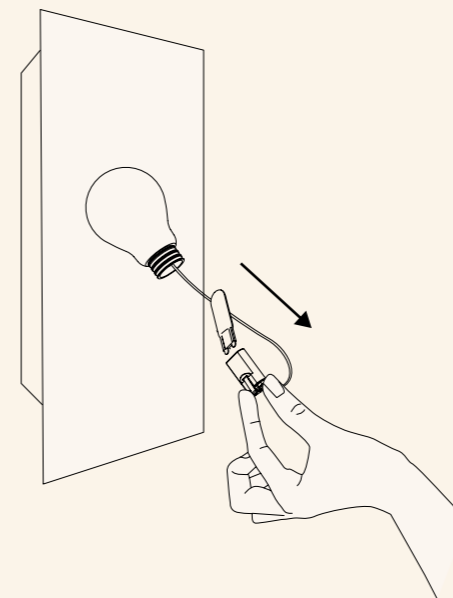

Idea Applique White

Size / Dimensione:
 21 x 8,5 h. 26,5 cm
 8-1/4" x 3-1/4" h. 10-1/4"

hanami

BY ADRIANO RACHELE

technical details p. 533



Size / Dimensione:
Ø65 x h. 21 cm - 25-1/2" x h. 8-1/4"

Lighting / Illuminazione:
7 x 5W G9 LED Dimmable

SUSPENSION
p.200

WALL LAMP

CEILING LAMP
p.290

TABLE LAMP

FLOOR LAMP

la lollo

BY LORENZA BOZZOLI



SUSPENSION
p.162

WALL LAMP

CEILING LAMP

TABLE LAMP

FLOOR LAMP
p.464



A TRIBUTE TO THE
**ROA
RING**
'50S



Every Slamp lamp undergoes a precise, transformative, creative ritual that metamorphoses a 2 dimensional sheet into a 3-dimensional shape through hand-folding.

La creazione di ogni lampada Slamp richiede una precisa ritualità che trasforma tramite un sistema di piegature eseguite a mano, un foglio piano in un volume tridimensionale.



Size / Dimensione: 28 x 16 x h.30 cm - 11" x 6-1/4" x h. 11 3/4".

Lighting Illuminazione: 2 x 6W LED Filament Bulb E14/E12.

clizia

MAMA NON MAMA

BY ADRIANO RACHELE

technical details p. 524



Clizia Ceiling/Wall Medium



Clizia Applique

- 
 SUSPENSION
p.146
- 
 WALL LAMP
- 
 CEILING LAMP
p.282
- 
 TABLE LAMP
p.342
- 
 FLOOR LAMP

Available in 4 sizes and 2 designs. Left: Clizia Ceiling/wall Medium; right: Clizia Applique.

Disponibile in 4 misure e 2 design alternativi. A sinistra: Clizia Ceiling/wall Medium; A destra: Clizia Applique

clizia PIXEL

BY ADRIANO RACHELE

technical details p. 524



- 
 SUSPENSION
 p.150
- 
 WALL LAMP
- 
 CEILING LAMP
 p.284
- 
 TABLE LAMP
- 
 FLOOR LAMP

The integrated magnetic system facilitates cleaning and maintenance. Available in 4 sizes and 2 other designs (ceiling/wall and applique)

Dotata di attacco magnetico per veloce pulizia e manutenzione. Disponibile in 4 misure e 2 design alternativi (ceiling/wall e applique).

clizia FUMÉ

BY ADRIANO RACHELE



Clizia Fumè Mini

- 
 SUSPENSION
 p.152
- 
 WALL LAMP
- 
 CEILING LAMP
 p.286
- 
 TABLE LAMP
 p.344
- 
 FLOOR LAMP
 p.480

technical details p. 524



Clizia Fumè Large

Clizia Fumè Mini

MAGNETIC
SYSTEM

WALL LAMP

clizia

BY ADRIANO RACHELE



Clizia Large White



SUSPENSION
p.156



WALL LAMP



CEILING LAMP
p.288



TABLE LAMP
p.348



FLOOR LAMP
p.480



Slamp's handmade approach is a precise ritual of cuts, folds and bends that transform a flat technopolymer sheet into a decorative three-dimensional shape.

L'allestimento manuale delle lampade Slamp segue una precisa ritualità che trasforma, tramite tagli, incastri e piegature una lastra piana di tecnopolimero in un volume tridimensionale.

technical details p. 524

veli FOLIAGE

BY ADRIANO RACHELE

technical details p. 548



Veli Large



Integrated magnetic hanging system. Available in 3 size: L, M, Mini.

Dotata di attacco magnetico, disponibile in 3 misure: L, M, Mini.

SUSPENSION
p.182

WALL LAMP

CEILING LAMP
p.270

TABLE LAMP
p.360

FLOOR LAMP

veli COUTURE

BY ADRIANO RACHELE



Veli Medium



technical details p. 547

Veli Large

SUSPENSION
p.186

WALL LAMP

CEILING LAMP
p.272

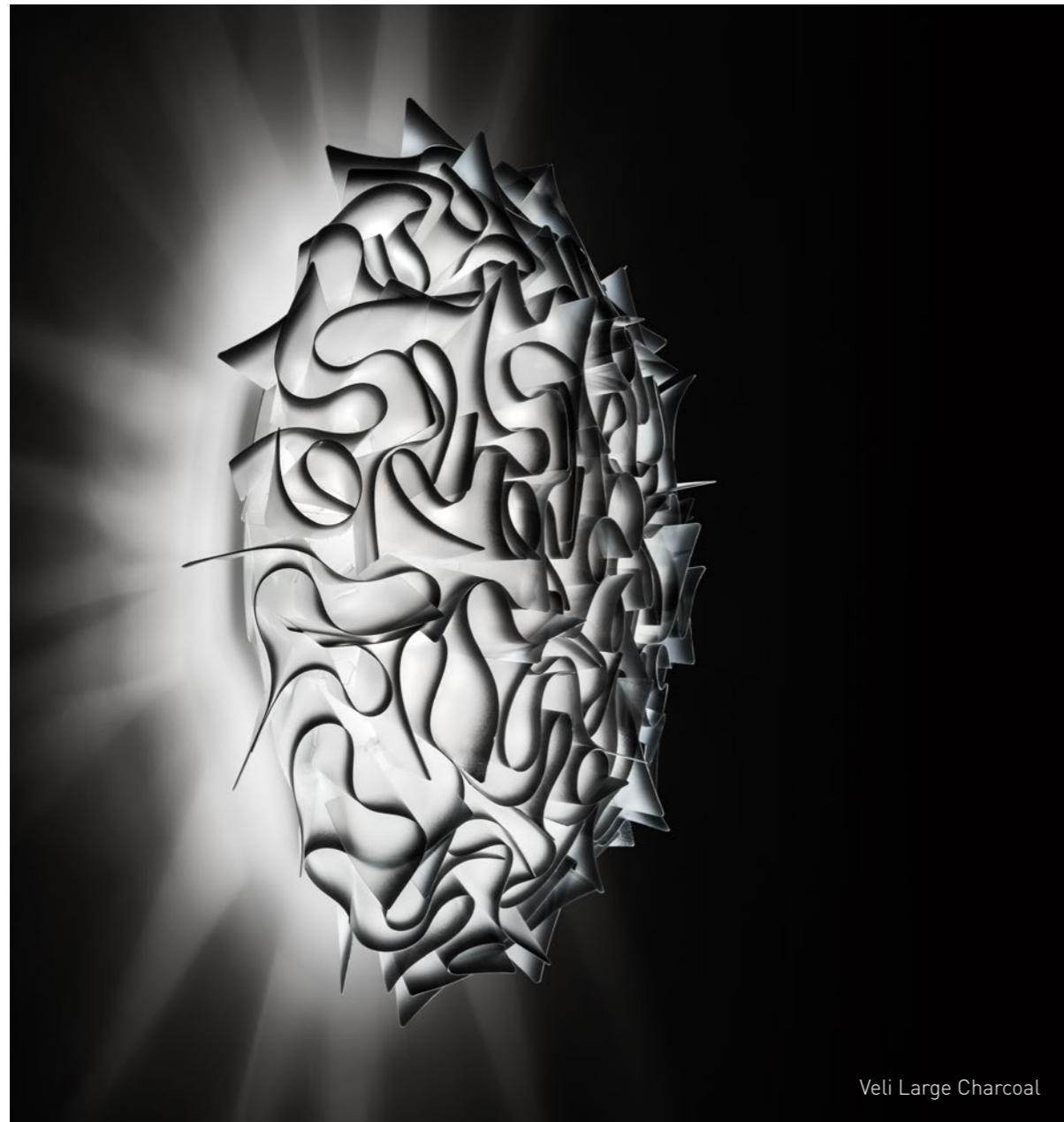

TABLE LAMP
p.362

FLOOR LAMP

veli

BY ADRIANO RACHELE

technical details p. 547



Veli Large Charcoal



Veli Medium Opal

-  SUSPENSION
p.194
-  WALL LAMP
-  CEILING LAMP
p.278
-  TABLE LAMP
p.362
-  FLOOR LAMP

reddot design award
honourable mention 2012

veli PRISMA

BY ADRIANO RACHELE



Veli Medium Prisma

SUSPENSION
p.192

WALL LAMP

CEILING LAMP
p.274

TABLE LAMP

FLOOR LAMP



Veli is made with a precise ritual of cuts, fold and handmade bends.
Veli è realizzata con un preciso rituale di tagli, pieghe e incastri
realizzati a mano.

veli GOLD, SILVER AND COPPER

BY ADRIANO RACHELE

technical details p. 547



Slamp's unique, flexible technopolymers undergo metallisation through an exclusive process of aluminium vapourisation that guarantees resistance and shine.

I tecnopolimeri flessibili e unici di Slamp subiscono un esclusivo processo di metallizzazione a vapori di alluminio che garantisce brillantezza e resistenza.

- 
 SUSPENSION
 p.190
- 
 WALL LAMP
- 
 CEILING LAMP
 p.276
- 
 TABLE LAMP
- 
 FLOOR LAMP

la belle étoile

BY ADRIANO RACHELE

technical details p. 536



La Belle Étoile White

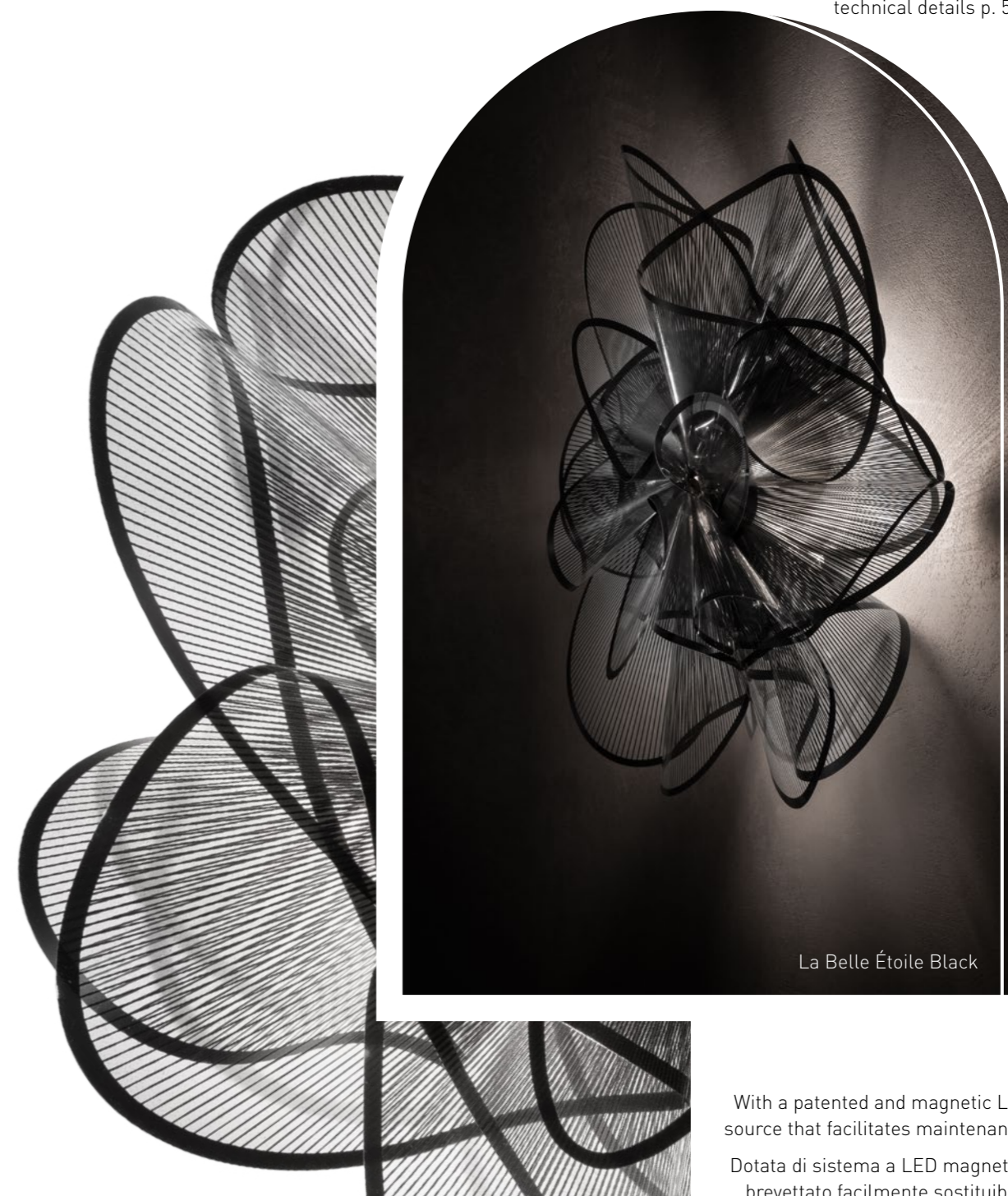

La Belle Étoile Black

With a patented and magnetic LED source that facilitates maintenance.

Dotata di sistema a LED magnetico brevettato facilmente sostituibile.

SUSPENSION
p.172

WALL LAMP



CEILING LAMP
p.292

TABLE LAMP

FLOOR LAMP

étoile

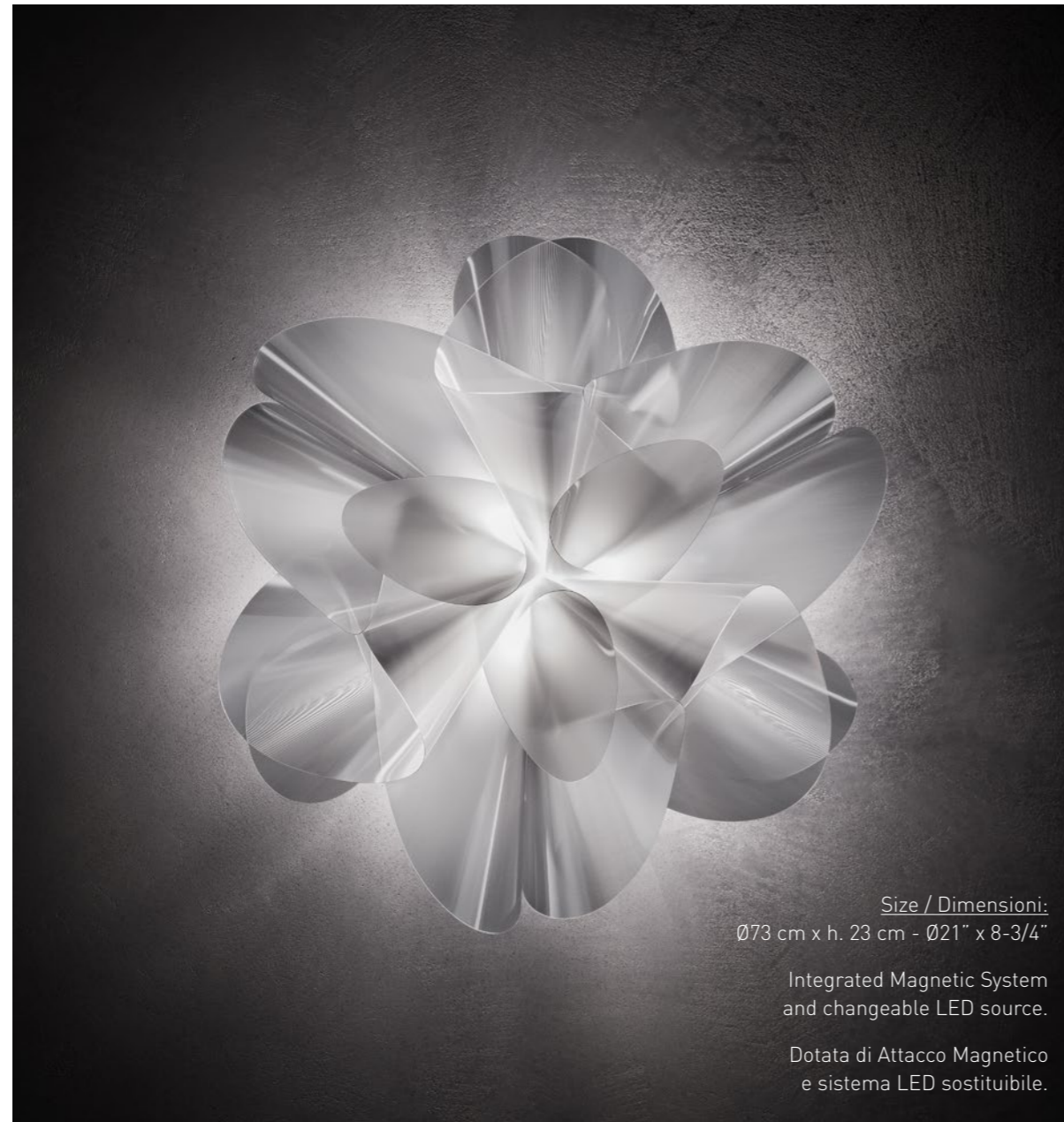
BY ADRIANO RACHELE



Size / Dimensioni:
Ø73 cm x h. 23 cm - Ø21" x 8-3/4"

Integrated Magnetic System
and changeable LED source.

Dotata di Attacco Magnetico
e sistema LED sostituibile.

SUSPENSION
p.180

WALL LAMP

CEILING LAMP
p.294

TABLE LAMP

FLOOR LAMP



PER
FEC
TLY
BALANCED

WALL LAMP

drusa

BY ADRIANO RACHELE



Drusa Velvet



SUSPENSION
p.212



WALL LAMP



CEILING LAMP
p.296



TABLE LAMP



FLOOR LAMP



technical details p. 528

Drusa White

Size / Dimensioni:
Ø60 cm x h. 20 cm - Ø23-1/2" x h. 8"

Lighting / Illuminazione:
4 x 12W E27/E26 LED Filament Bulbs

nigel coates

“I LOVE THE FLIRTATIOUS
RELATIONSHIP BETWEEN
SPACE AND OBJECT”

SLAMP:



bios

BY NIGEL COATES

technical details p. 519



Available in 3 dimensions / Disponibile in 3 dimensioni:
Large: Ø72 x h. 15 cm - Ø28-1/4" x h. 6"
Medium: Ø54 x h. 12 cm - Ø21-1/4" x h. 4-3/4"
Small: Ø36 x h. 8,5 cm - Ø14-1/4" x h. 3-1/4"



SUSPENSION



WALL LAMP



CEILING LAMP
p.300

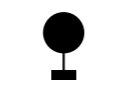
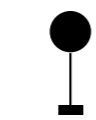

TABLE LAMP
p.382



FLOOR LAMP
p.492

dafne

BY NIGEL COATES



SUSPENSION
p.240

WALL LAMP
p.304

CEILING LAMP
p.304

TABLE LAMP
p.384

FLOOR LAMP
p.494

technical details p. 527



META
MORPHIC
LIGHT

WALL LAMP

fiorella

BY NIGEL COATES

technical details p. 531



Size / Dimensioni:
34 x 22 x h.19 cm
13-1/2" x 8-3/4" x h. 7-1/2"

FLOWER

SHAPE

-  SUSPENSION
p.226
-  WALL LAMP
-  CEILING LAMP
-  TABLE LAMP
p.364
-  FLOOR LAMP

fabula

BY COSTANTINO MOROSIN



Large: Ø60 cm x 25cm - Ø23-1/2" x h. 9-3/4" - 5 x 12W E27/E26 LED Filament Bulbs
Small: Ø48,5 cm x 21cm - Ø19" x h. 8" - 3 x 12W E27/E26 LED Filament Bulbs

SUSPENSION
p.208

WALL LAMP

CEILING LAMP
p.298

TABLE LAMP

FLOOR LAMP

SILKY
RIBBON OF FABRIC

medusa

BY NIGEL COATES

technical details p. 541



Inspired by classic, crystal-clad chandeliers, Medusa has an internal mirrored vessel that enhances the light extending from 4 surrounding arms.

Ispirata ai classici lampadari con cristalli, Medusa è dotata di un cestello specchiato che enfatizza la luce e di 4 braccia che l'avvolgono.

- 
 SUSPENSION
p.234
- 
 WALL LAMP
- 
 CEILING LAMP
- 
 TABLE LAMP
- 
 FLOOR LAMP

lilibet

BY NIGEL COATES



SUSPENSION
p.218



WALL LAMP



CEILING LAMP



TABLE LAMP



FLOOR LAMP

technical details p. 540



DRA
MA
TIC
COLLECTION

The radial structure easily connects to the central Cristalflex® cylinder, reflecting Lilibet's luxurious transparent crystals.

Lilibet è realizzata con una struttura radiale che si aggancia facilmente al cestello centrale in Cristalflex®.

venti

BY ALESSANDRO MENDINI



SUSPENSION



WALL LAMP



CEILING LAMP
p.308



TABLE LAMP
p.378



FLOOR LAMP
p.502

technical details p. 549



Available in 3 dimensions / Disponibile in 3 dimensioni:
Large: Ø72 x h. 15 cm - Ø28-1/4" x h. 6" ; Medium: Ø54 x h. 12 cm - Ø21-1/4" x h. 4-3/4"
Small: Ø36 x h. 8,5 cm - Ø14-1/4" x h. 3-1/4"

floor lamps

*"I WATCH YOU RUN YOUR FINGERS ALONG THOSE
AMBER PAGES, YOUR EYES QUICKLY JUMPING FROM
ONE LINE TO ANOTHER, YOUR PROFILE SLIGHTLY
DEFINED BY THE LIGHT THAT ILLUMINATES YOUR FACE".
POETRY CAN COME TO LIGHT ANY DAY
WHEN ILLUMINATED BY A SOFA-SIDE LAMP...*

*"TI GUARDO SCORRERE LE DITA SULLE PAGINE
DI CARTA AMBRATA, GLI OCCHI SALTANO CELERI
DA UNA RIGA ALL'ALTRA, IL PROFILO APPENA
DELINEATO DALLA LUCE CHE TI ILLUMINA IL VOLTO".
OGNI GIORNO PUÒ NASCERE UNA POESIA DA
QUELLA LAMPADA ACCANTO AL DIVANO...*

SLAMP:

hugo

BY SLAMP CREATIVE DEPARTMENT

technical details p. 535



Size / Dimensioni:
 9 x h. 207 cm, base Ø32 cm
 3-1/2" x h.80-3/4", base Ø12-1/2"



- 
 SUSPENSION
 p.106
- 
 WALL LAMP
- 
 CEILING LAMP
- 
 TABLE LAMP
- 
 FLOOR LAMP



PLAY VIDEO



Soft touch dimming system (0-100) with ergonomically placed button.
Sistema di dimmerazione 0-100 con pulsante soft touch in posizione ergonomica



The design and bend of the floor lamp were inspired by the outreached hands of Michelangelo's "Last Judgement" in the Sistine Chapel. The light touch dimming system is ergonomically placed, and blinks when the lamp is at minimum and maximum brightness.

L'inclinazione e il design della lampada da terra sono ispirati al tocco delle mani dei protagonisti del Giudizio Universale, il dipinto di Michelangelo nella Cappella Sistina. Il sistema di dimmerazione a sfioramento, collocato in posizione ergonomica, lampeggia quando raggiunge il punto massimo e minimo d'intensità luminosa.

la lollo

BY LORENZA BOZZOLI

technical details p. 538



La Lollo Silver



La Lollo Silver

La Lollo Gold

Size / Dimensioni:
Base: Ø29 cm - Ø11-1/4"
Cylinder: Ø13 x h. 163 cm
Ø5" x h. 63-1/2"

SUSPENSION
p.162

WALL LAMP
p.414

CEILING LAMP

TABLE LAMP

FLOOR LAMP



La Lollo Silver

An elegant, refined column that resembles blown glass from Murano: high tech, unbreakable, easily transported, and highly sophisticated.

Una colonna di luce elegante e raffinata, che ricorda la trama del vetro cannettato della tradizione muranese in una versione high-tech, infrangibile, facilmente trasportabile e sofisticata.



La Lollo Gold

studio
job
“LIGHT IS LIFE”

SLAMP:



© Mark Cocksedge

the lightning archives

OF STUDIO JOB



Love Peace Joy



Perished

-  SUSPENSION
-  WALL LAMP
-  CEILING LAMP
-  TABLE LAMP
-  FLOOR LAMP



technical details p. 544

ICONOGRAPHIC GRAMMAR

Faena Art



Size / Dimensioni:
37 x 21 x h. 160 cm
14-1/2" x 8-1/4" x h. 62"

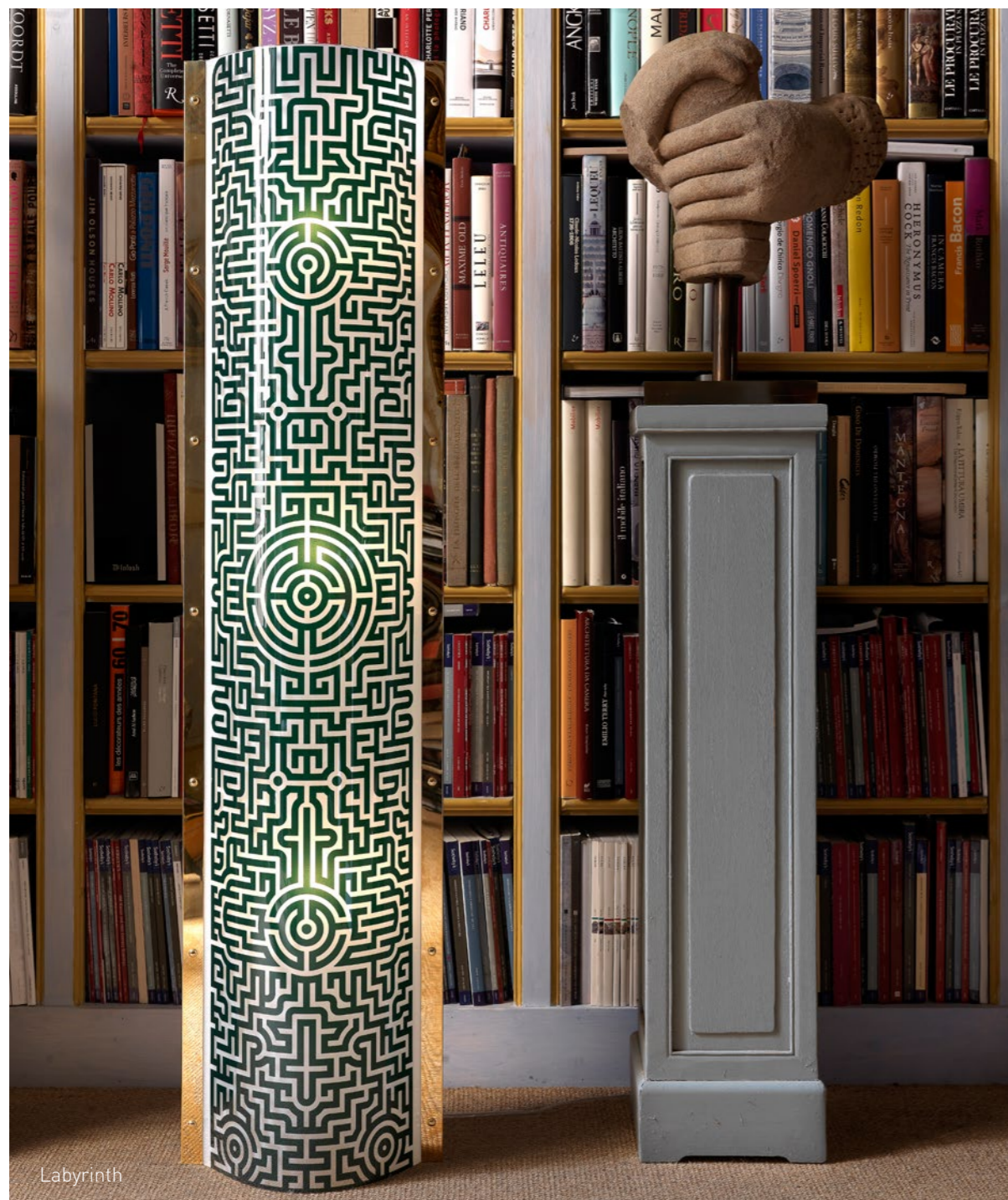

Labyrinth

An iconographic grammar created from Dadaist derivatives drove Studio Job to write an ode to Slamp's original masterpiece from the 90's, the Tube. The collection narrates their poetry, aura, history, and daring design.

Con una grammatica iconografica di derivazione dadaista, Studio Job scrive un'ode al Tube - masterpiece di Slamp degli anni '90 - per narrarne la poetività, l'aura, la storia e l'audacia decorativa.

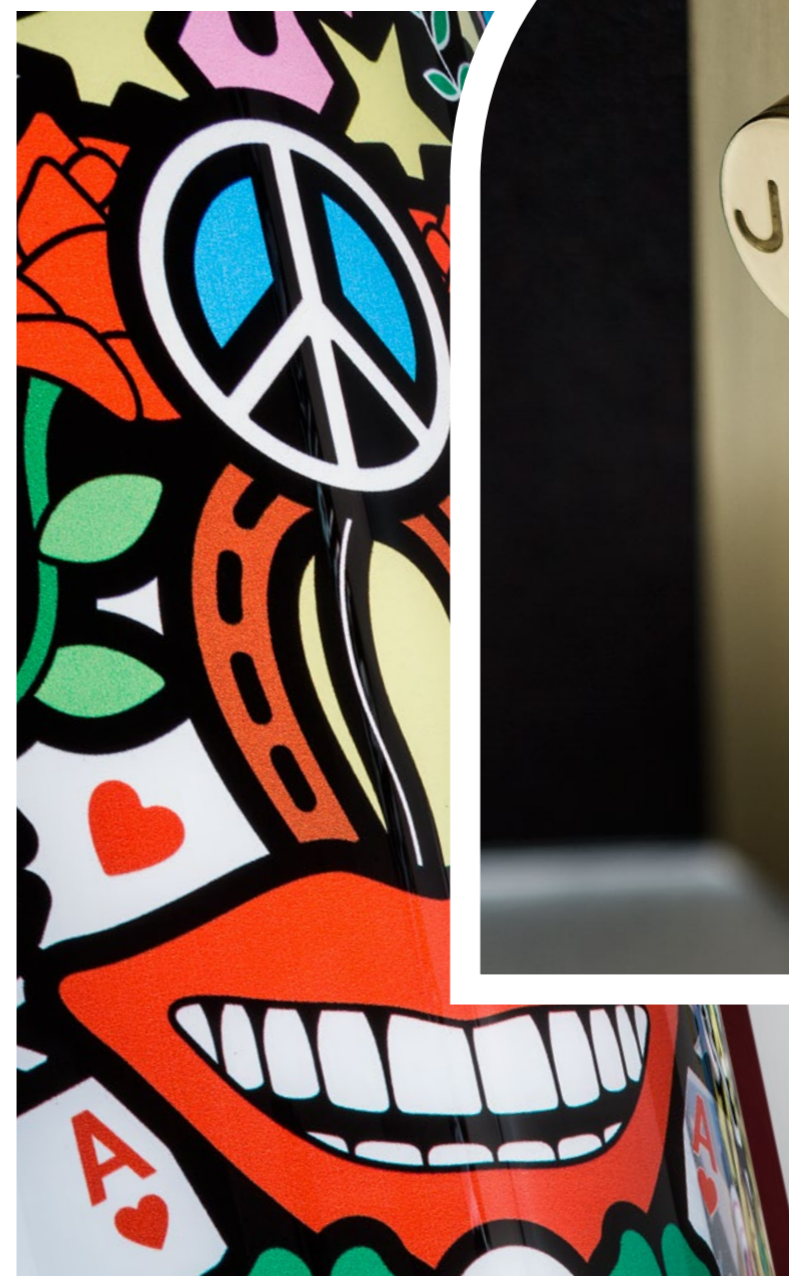

Close-up of the brass profile and shade print.

Dettaglio del profilo ottonato e della stampa del diffusore.

bach

BY FRANCESCO PARETTI

technical details p. 518



Bach XL White

Size / Dimensioni:

XXL: Ø31,5 cm x h. 184 cm - Ø12-1/2" x h. 72-1/2";
XL: Ø31,5 cm x h. 161 cm - Ø12-1/2" x h. 63-1/2"





Bach XXL Gold

Bach is statuary, with elegant yet rigorous curves, bringing fluid, linear movement and illumination to any interior.

Bach è uno corpo statuario e dalle tinte chiare. Le sue eleganti ma rigorose forme si legano alle moderne curvature capaci di seguire perfettamente le linee di ogni ambiente.



STATUARY
ELEGANCE

clizia

BY ADRIANO RACHELE

technical details p. 526



Clizia Fumè



Clizia White

NATURAL
RAL
SHAPE

FLOOR LAMP

SUSPENSION
p.152

WALL LAMP
p.422

CEILING LAMP
p.286

TABLE LAMP
p.344

FLOOR LAMP

Size / Dimensioni:

Ø63 cm x h. 164 cm - Ø24-3/4" x h. 64"

Available in 4 colours, with grey structure (legs)

Disponibile in 4 colori con struttura grigia (gambe).

cactus GOLD

BY ADRIANO RACHELE

technical details p. 521



Hand-inserted folds transform into an ironic, irreverent lamp, available in two floor and two table sizes.

Incastri eseguiti a mano per una lampada ironica e irriverente disponibile in 2 misure da terra e 2 da tavolo.



cactus PRISMA

BY ADRIANO RACHELE

technical details p. 520

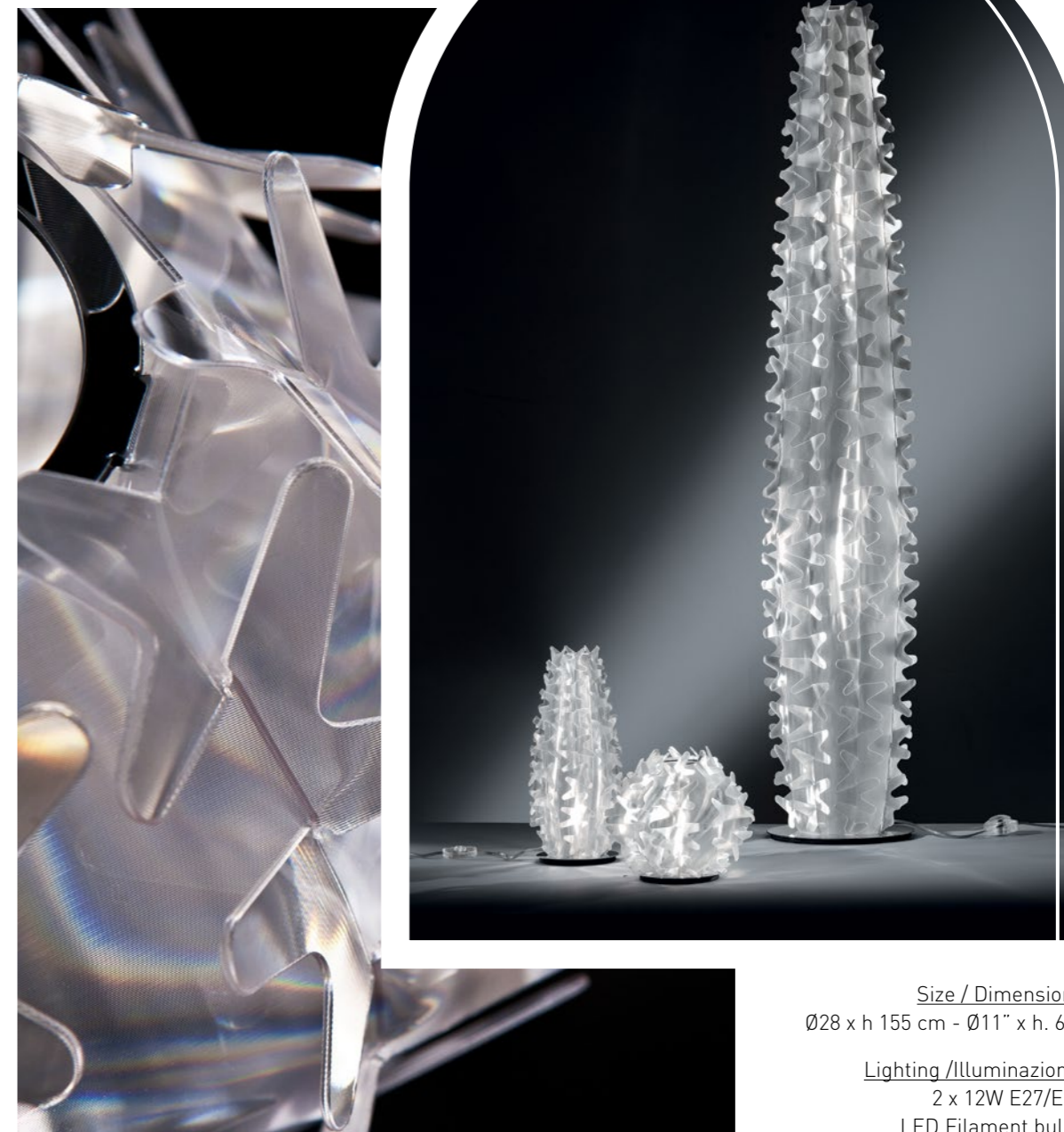

Size / Dimensioni:
 Ø28 x h 155 cm - Ø11" x h. 61"

Lighting / Illuminazione:
 2 x 12W E27/E26
 LED Filament bulbs

- 
 SUSPENSION
- 
 WALL LAMP
- 
 CEILING LAMP
- 
 TABLE LAMP
 p.370
- 
 FLOOR LAMP

zanini de zanine

“LIGHT EVOKES A
SPACE’S ATMOSPHERE”

SLAMP:



flora

BY ZANINI DE ZANINE

technical details p. 531



Flora Gold



Flora Pewter

-  SUSPENSION p.204
-  WALL LAMP
-  CEILING LAMP
-  TABLE LAMP
-  FLOOR LAMP

Size / Dimensioni:
Ø50 cm x h. 170 cm - Ø19-3/4" x h. 67"



Flora White

Sixty petals surround a satin sphere illuminated from its core. The lamp is available in both a suspension as well as floor version resting on thin legs that resemble a flower's pistils.

60 petali avvolgono la sfera satinata, cuore lucente della lampada disponibile sia in versione a sospensione, che nella versione da terra dotata di sottili steli che ricordano i pistilli di un fiore.

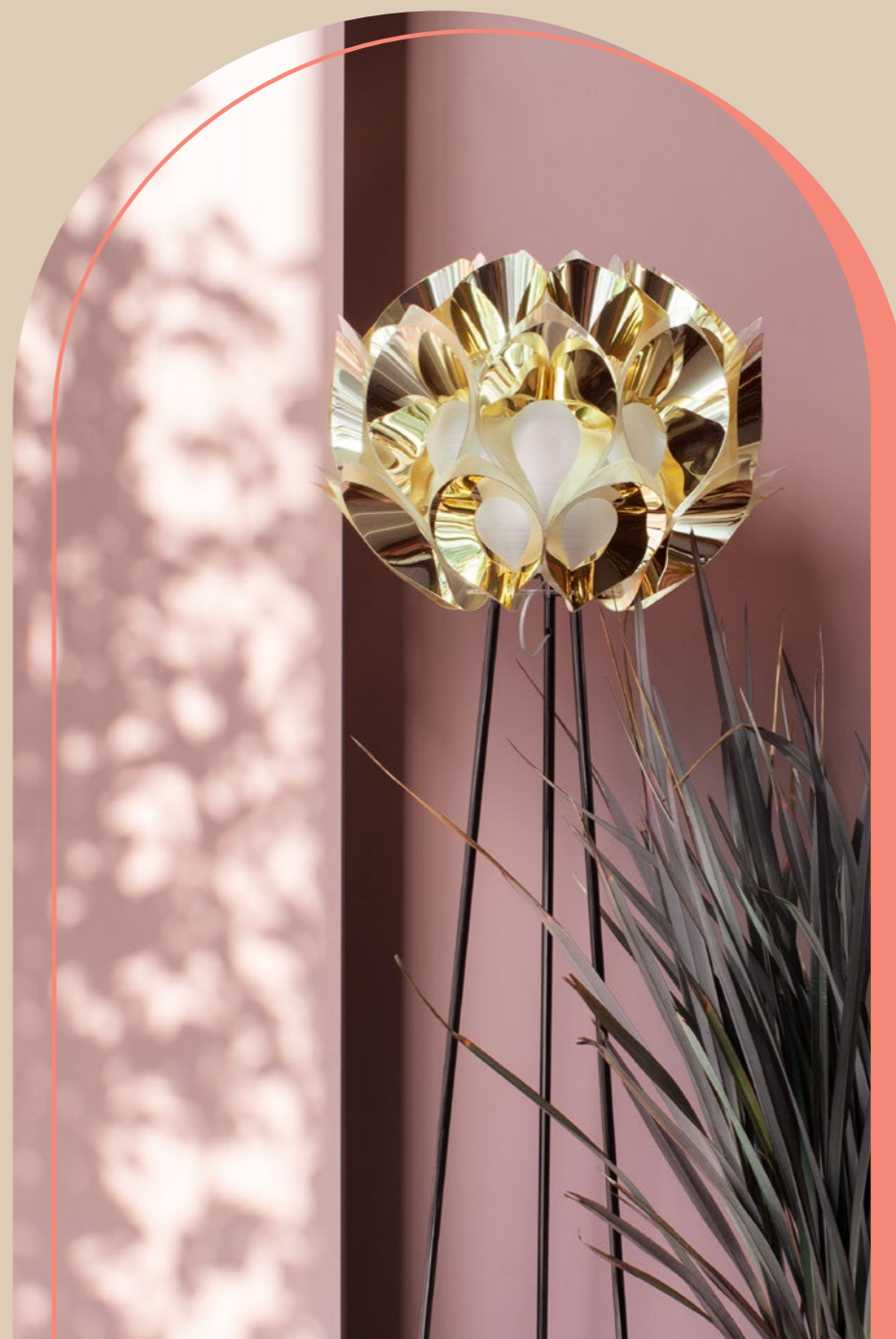

Flora Gold

bios

BY NIGEL COATES

technical details p. 520



Bios has two layers of Opalflex®, both with carefully selected incisions that let the light shine through, creating suggestive reflections and shadows.

Bios nasce dalla sovrapposizione di due strati di Opalflex® dai quali, attraverso i fori irregolari, filtra una luce che crea suggestivi giochi di luci e di ombre.



SUSPENSION



WALL LAMP
p.444



CEILING LAMP
p.300



TABLE LAMP
p.382



FLOOR LAMP

dafne

BY NIGEL COATES



SUSPENSION
p.240

WALL LAMP
p.446

CEILING LAMP
p.304

TABLE LAMP
p.384

FLOOR LAMP

technical details p. 526

Size / Dimensioni:
37 x 21 x h. 160 cm - 14-1/2" x 8-1/4" x h. 63"

las palmas

BY PAOLUCCI, STATERA

technical details p. 539



Size / Dimensione:
 XL: 44,5 x 40 x h. 153,5 cm
 17-1/2" x 15" x h. 60"
 L: 37,5 x 32 x h. 118 cm
 14" x 12" x h. 46-1/2"

- 
 SUSPENSION
- 
 WALL LAMP
- 
 CEILING LAMP
- 
 TABLE LAMP
 p.380
- 
 FLOOR LAMP

diamond

BY PAOLUCCI, STATERA

technical details p. 527



Size / Dimensioni:
L: 27 x 26 x h. 11 cm - 10-1/2 x 10-1/4" x h. 43-1/4"
M: 22 x 23 x h. 72 cm - 8-1/2" x 9" x h. 28"
With brushed aluminium base.
Base in alluminio satinato.



SUSPENSION



WALL LAMP



CEILING LAMP



TABLE LAMP
p. 376



FLOOR LAMP

ecstacity

BY NIGEL COATES

technical details p. 528

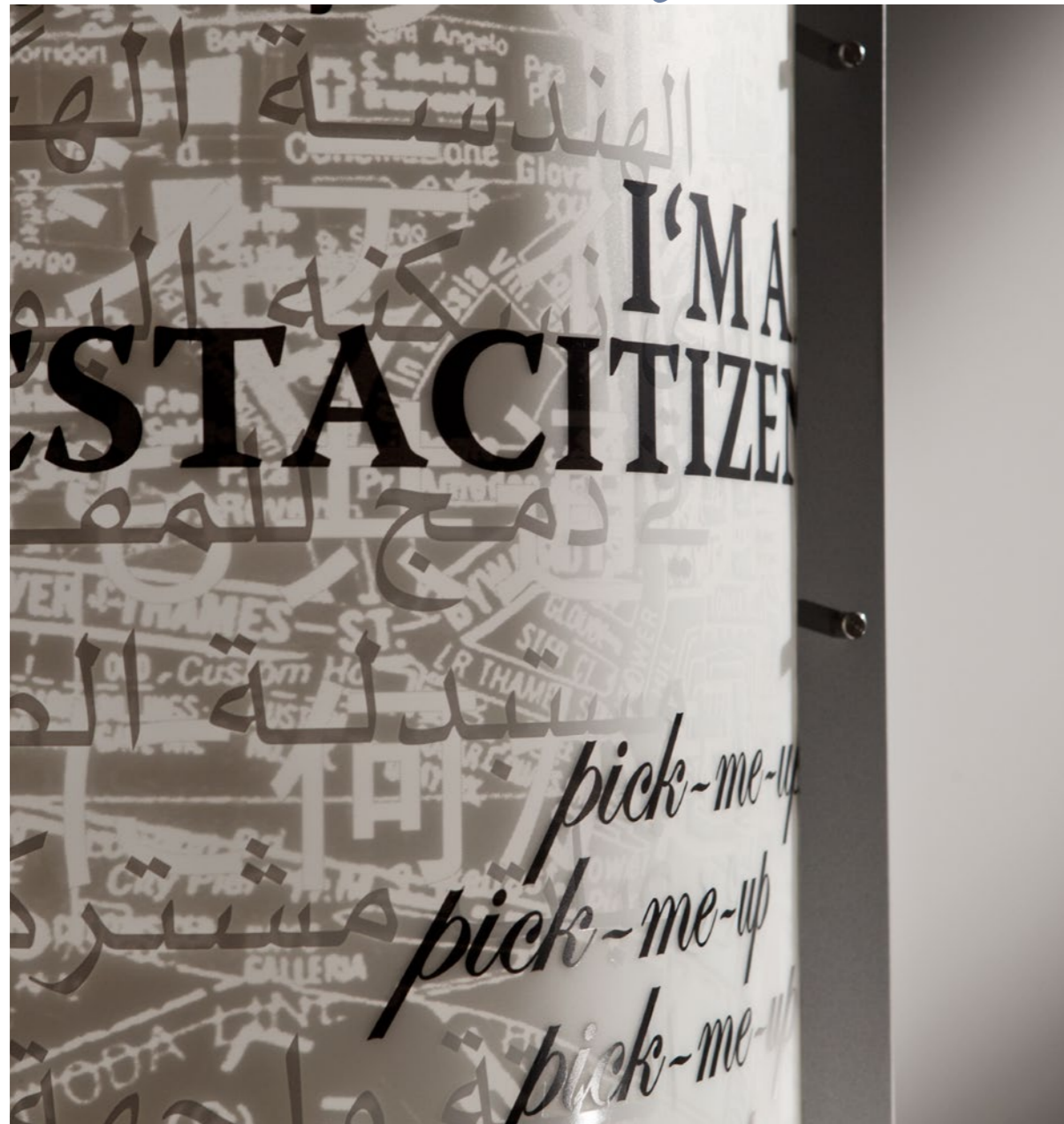

SUPERIMPOSED
GRAPHIC
 PRINTING

Aluminium sides. Dimmer included / Profili in alluminio. Dimmer incluso.

Size/Dimensioni: 37 x 21 x h. 160 cm - 14-1/2" x 8-1/4" x h. 63"



SUSPENSION

WALL LAMP

CEILING LAMP

TABLE LAMP

FLOOR LAMP

venti

BY ALESSANDRO MENDINI



SUSPENSION



WALL LAMP
p.456



CEILING LAMP
p.308



TABLE LAMP
p.378



FLOOR LAMP



Aluminium sides and dimmer included. - Profili in alluminio e dimmer incluso.

Size/Dimensioni: 37 x 21 x h. 160 cm - 14-1/2" x 8-1/4" x h. 63"

atlante

BY NIGEL COATES

technical details p. 516



-  SUSPENSION
p.232
-  WALL LAMP
-  CEILING LAMP
-  TABLE LAMP
-  FLOOR LAMP



Lighting / Illuminazione: 8 X 15W max
E14/E12 IBC/C bulbs

AN
ILLU
MINA
TED
ATLAS

FLOOR LAMP

heritage collections

FROM EARLY COLLECTIONS TO THE MOST
UNOBTAINABLE ONES. FOR THOSE WHO LOVE
MODERN ANTIQUES AND OTHERS WHO LOVE
TO SURROUND THEMSELVES WITH
TIMELESS ICONIC OBJECTS.

DALLE COLLEZIONI DEGLI ESORDI A QUELLE PIÙ
INTROVABILI. PER GLI AMANTI DEL MODERNARIATO
E DI CHI AMA CIRCONDARSI DI OGGETTI
ICONICI SENZA TEMPO.

SLAMP:

heritage

COLLECTIONS
TIMELESS ICONIC OBJECTS



GEO

**1997
SILVIO VILLA**
Two-dimensional like a map, and three-dimensional like a globe, united for the first time in a single design object.

Le 2 dimensioni di una cartina geografica e la tridimensionalità del mappamondo per la prima volta unite in un unico oggetto d'arredo.



RAVENNA

**1997
SILVIO VILLA**
The first experimentation with the textural graphics of the world's most beautiful Byzantine mosaics.

La prima sperimentazione di grafica a rilievo, permette di riprodurre su un tecnopolimero i mosaici bizantini più belli del mondo.



TOP KAPI

**1997
A. BARATTONI**
A daring gesture with irreverent traits see Swarovski crystals and technopolymers united for the first time.

Un gesto audace, a tratti irriverente: unire per la prima volta il cristallo di Swarovski a un tecnopolimero.



ETNO

**1997
SILVIO VILLA**
Tribal rhythms resound in this collection that accompanied entire generations of admirers.

Ritmi tribali sembrano risuonare in questa collezione che ha accompagnato intere generazioni di amatori.



FAHNE

**1997
A. MENDINI**
Alessandro Mendini's unmistakable fingerprint, translated into a colorful play that opens new horizons.

Il segno inconfondibile di Alessandro Mendini, traslato in un gioco di policromie, fa spazio ad un nuovo orizzonte di visione



OMBRE NAPOLETANE

**1998
R. DALISI**
A Renaissance genius under the shadow of Mt. Vesuvius in a collage of his coveted symbols, Dalisi pays homage to his city.

Maestro rinascimentale all'ombra del Vesuvio, con un collage di simboli a lui cari, Dalisi rende onore alla sua città.



KI WOK

**1998
A. BARATTONI**
Was covering a lamp in fur in Roma during the '90s folly or pure genius?

Che sia follia o puro genio quello di rivestire in pelliccia una lampada a Roma negli anni '90?



DEVIL

**2007
NIGEL COATES**
The layering of multiple, red metallized Steelflex® arrows make Devil graphic and seductive.

La sovrapposizione di frecce realizzate in Steelflex® metallizzato rosso rendono Devil grafica e seducente.



PACIS

**2009
NIGEL COATES**
Symbolising peace, a cascade of crystal runs through a crown of laurel leaves.

Da un'avveniristica corona d'alloro concentrica, che simboleggia la pace, scende una cascata di cristalli.



CREATURES

**2009
NIGEL COATES**
Inspired by a marine animal that almost comes alive with light. Created from resistant, bright white Opalflex® with many smaller inserts in Fumé Cristalflex®.

Nel design richiama una creatura marina, realizzata in resistente Opalflex® white con piccoli inserti di Cristalflex® Fumé.



GIRA FIORE

**2010
ELODIE LONGO**

The splendid layered crown made of Opalflex® petals is the perfect recreation of the endless game of tag between the Sun and sunflowers.

La splendida corolla piegata realizzata da petali in Opalflex® ricrea perfettamente l'eterno gioco dei girasoli nel rincorrere il sole.



CHA PEAU

**2011
NIGEL COATES**

The mirrored inside is enveloped by a black layer, creating particularly elegant refractions.

L'interno è specchiato, avvolto in uno strato nero, per creare una elegante rifrazione della luce



BAT TISTA

**2011
NIGEL COATES**

This artistic lamp has a base carved from antique poplar beams, supporting a Cristalflex® column.

In questa artistica scultura luminosa la colonna di Cristalflex® è supportata da una base in pioppo ricavata da antiche travi riciclate.



FAR ETTO

**2011
NIGEL COATES**

A central cone surrounded by layered rings that play with the light without losing form.

Un cono centrale dove cerchi sovrapposti giocano con la luce senza perdere la direzione.



MILLE BOLLE

**2011
A. RACHELE**

Tiny sheets of iridescent polycarbonate that casts a kaleidoscope of luminous soap bubbles.

Piccoli fogli di policarbonato iridescente che ricreano i riflessi delle fugaci bolle di sapone.



HEL IOS

**2012
SLAMP TEAM**

The fluidity of a waterfall combined with the power of a LED source on a Carrara marble base.

La suggestione dell'acqua e la potenza del LED vengono sostenute dalla base in marmo di Carrara.



PUN CTUM

**2013
NIGEL COATES**

A LED lamp specifically design for corners, interrupting linearity with its mirrored surface.

Lampada a LED specchiata progettata per esaltare gli angoli rompendone la linearità.



CRO CCO

**2013
NIGEL COATES**

The fauna-inspired shape is realized with digital printing on Lentiflex®, creating a silky morphing effect.

La sua forma zoomorfa è realizzata in Lentiflex® stampato digitalmente che crea un effetto morphing setoso.



CUO RE

**2013
NIGEL COATES**

Ancestral symbol with a modern twist, Cuore representing loyalty and passion.

Cuore è un simbolo ancestrale in chiave contemporanea che rappresenta lealtà e devozione.



DESERT ROSE

**2017
DORIANA AND
MASSIMILIANO FUKSAS**

The light only enhances the rhythm of the lamp's geometries, begun with a two-dimensional sheet transformed into ethereal shapes.

La luce rivela il ritmo delle geometrie, che partendo da un materiale bidimensionale si trasformano in un volume complesso.



technical details

SLAMP:

ACCORDÉON SUSPENSION

LED: 52W 100 ~ 240V - 5.900 Lumen
 2700 Kelvin or 3000 Kelvin
 220V version dimmable with PWM / 0-10
 110V version Dimmable with: Triac
 Additional dimming system Dali, Bluetooth, Casambi, Triac upon request
 MADE OF: Lentiflex® / Goldflex® / Steelflex®

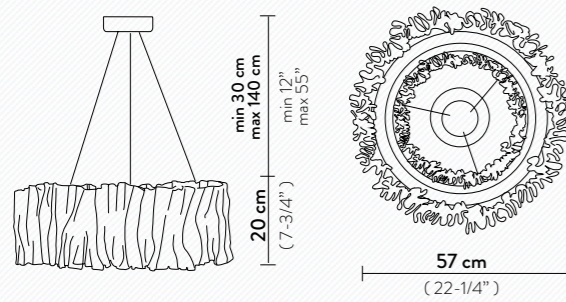

COLOURS:

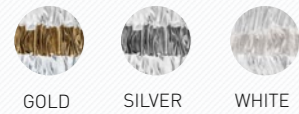

ACCORDÉON TABLE

2 X 12W LED Filament Bulbs E27/E26
 + 1 X 6W LED Filament Bulbs E14/E12
 MADE OF: Lentiflex® / Cristalflex®
 WITH: Two Position Light Switch - Magnetic System®

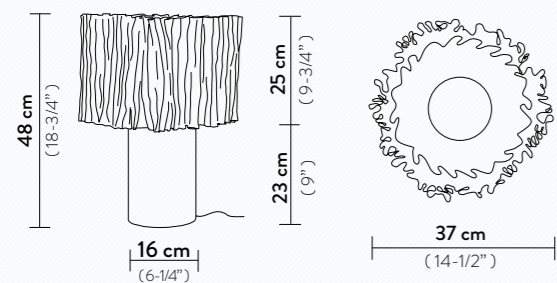

COLOURS:



PRISMA



2 INDEPENDENT LIGHT SOURCES

ACCORDÉON VERTICAL SUSPENSION

1 X 10W LED Filament Bulb E14/E12
 Dimmable with dimmable bulbs (max dim. Ø5 cm - 2")
 MADE OF: Lentiflex® / Brushed Goldflex®
 WITH: Hand molded diffusor, black wrapped electric wire

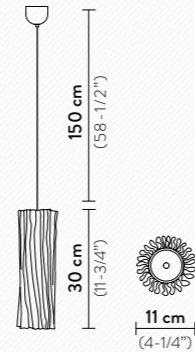

COLOURS:

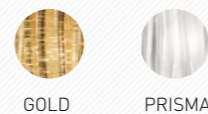

ACCORDÉON BATTERY TABLE

LED: 1.3W dimmable- 150 Lumen - 2700 Kelvin
 Rechargeable Li-ion Polymer Cell 3.7 Vdc 2500mAh Charge 5 Vdc 1A.
 BATTERY DURATION: at max intensity around 6.5 hours duration, at min intensity around 60 hours duration.
 MADE OF: Lentiflex®, Anodized aluminium
 WITH: USB / DC plug included
 USB Multicharger station (20 ports) upon request

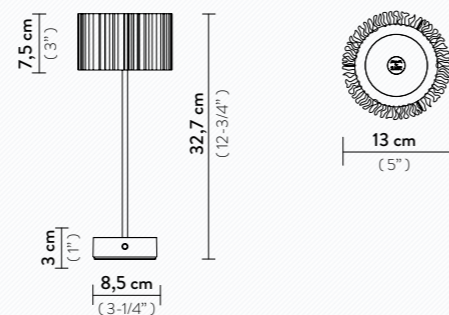

COLOURS:



PRISMA/BRASS with black base



PRISMA/BRASS with white base



TOUCH DIMMER



BATTERY POWERED

ARIA APPLIQUE

2 X 6W LED Filament Bulbs E14/E12
 + 1 X 6W Spot LED Bulb E14/E12
 Dimmable with dimmable bulbs
 MADE OF: Cristalflex® and Lentiflex®

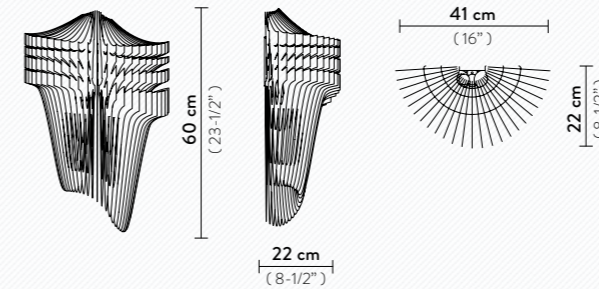

COLOURS:

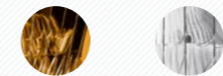

GOLD

TRANSPARENT

ARIA SUSPENSION XL

6 X 12W LED Filament Bulbs E27/E26
 + 1 X 11W Spot LED Bulb E27/E26
 Dimmable with dimmable bulbs
 MADE OF: Cristalflex® and Lentiflex®

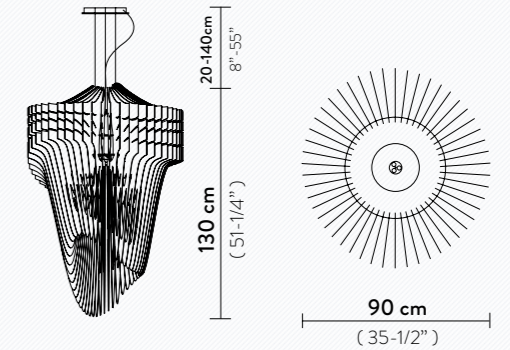

COLOURS:



BLACK FADE

TRANSPARENT

ARIA SUSPENSION L

4 X 12W LED Filament Bulbs E27/E26
 + 1 X 11W Spot LED Bulb E27/E26
 Dimmable with dimmable bulbs
 MADE OF: Cristalflex® / Lentiflex®

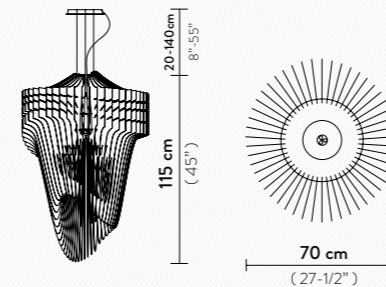

COLOURS:

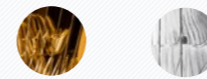

GOLD

TRANSPARENT

ARIA SUSPENSION M

3 X 12W LED Filament Bulbs E27/E26
 + 1 X 7W Spot LED Bulb E27/E26
 Dimmable with dimmable bulbs
 MADE OF: Cristalflex® / Lentiflex®

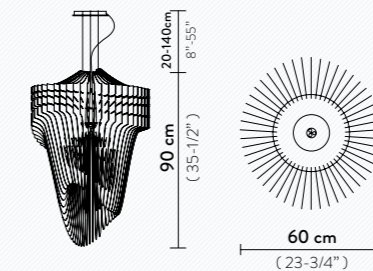

ARIA SUSPENSION S

2 X 12W LED Filament Bulbs E27/E26
 + 1 X 7W Spot LED Bulb E27/E26
 Dimmable with dimmable bulbs
 MADE OF: Cristalflex® / Lentiflex®

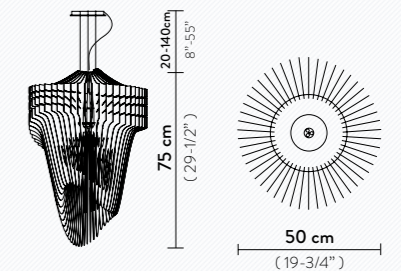

ATLANTE SUSPENSION

8 X 15W max IBC/C Bulbs E14/E12
MADE OF: Cristalflex®

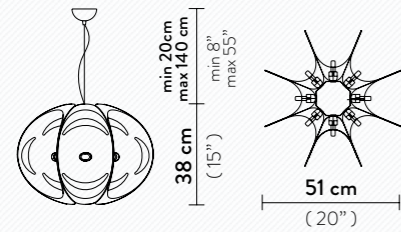

COLOURS:



FUMÉ

ATLANTE FLOOR

8 X 15W max IBC/C Bulbs E14/E12
MADE OF: Cristalflex®
WITH: Stainless Steel structure

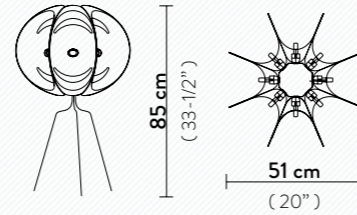

COLOURS:



FUMÉ

AURORA CEILING LARGE

1 X 12W LED Filament Bulb E27/E26
Dimmable with dimmable bulbs
MADE OF: Plainflex® / 97 Crystals
WITH: Magnetic System®

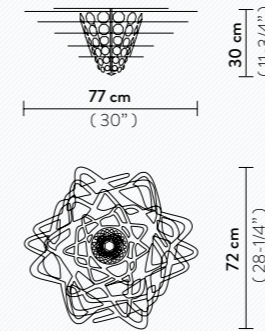

COLOURS:



BLACK



WHITE

AURORA CEILING MINI

1 X 12W LED Filament Bulb E27/E26
Dimmable with dimmable bulbs
MADE OF: Plainflex® / 61 Crystals
WITH: Magnetic System®

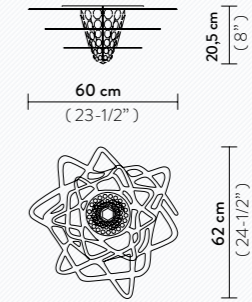

MAGNETIC SYSTEM



BLACK



WHITE



FUMÉ



TRANSPARENT

ATMOSFERA SUSPENSION

2 X 12W LED Filament Bulbs E27/E26
Dimmable with dimmable bulbs
MADE OF: Methacrylate / Goldflex®
or Pewterflex®
WITH: Hand - finished Sphere

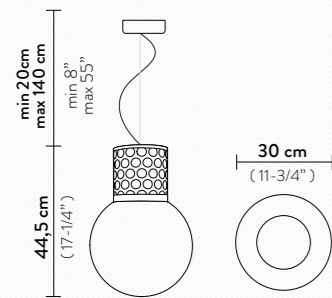

COLOURS:



GOLD



PEWTER

ATMOSFERA TABLE MEDIUM

2 X 12W LED Filament Bulbs E27/E26
MADE OF: Methacrylate / Goldflex®
or Pewterflex®
WITH: Hand - finished Sphere

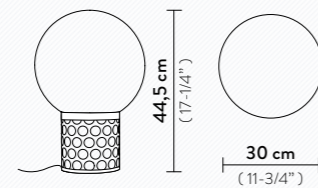

COLOURS:



GOLD



PEWTER

ATMOSFERA TABLE SMALL

2 X 6 W LED Bulb G9
MADE OF: Methacrylate / Goldflex®
or Pewterflex®
WITH: Hand - finished Sphere

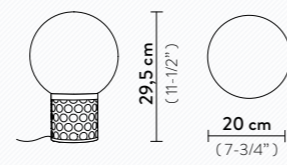

2 INDEPENDENT LIGHT SOURCES

AVIA SUSPENSION XL

6 X 12W LED Filament Bulbs E27/E26
+ 1 X 11W Spot LED Bulb E27/E26
Dimmable with dimmable bulbs
MADE OF: Cristalflex® / Lentiflex®

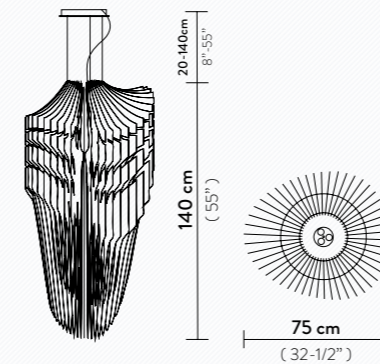

COLOURS:



BLACK FADE



WHITE FADE

AVIA SUSPENSION L

4 X 12W LED Filament Bulbs E27/E26
+ 1 X 11W Spot LED Bulb E27/E26
Dimmable with dimmable bulbs
MADE OF: Cristalflex® / Lentiflex®

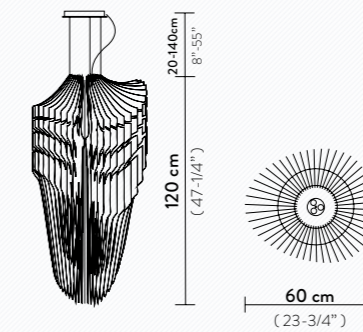

AVIA SUSPENSION M

3 X 12W LED Filament Bulbs E27/E26
+ 1 X 7W Spot LED Bulbs E27/E26
Dimmable with dimmable bulbs
MADE OF: Cristalflex® / Lentiflex®

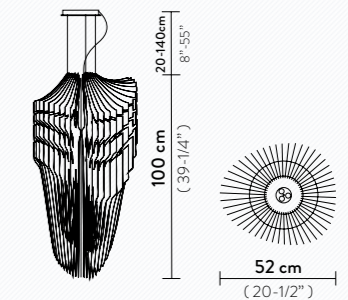

AVIA SUSPENSION S

2 X 12W LED Filament Bulbs E27/E26
 + 1 X 7W Spot LED Bulb E27/E26
 Dimmable with dimmable bulbs
 MADE OF: Cristalflex® / Lentiflex®

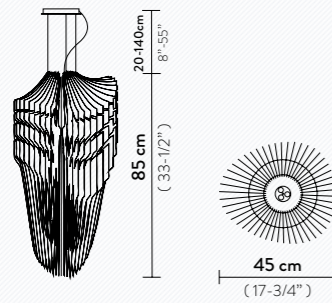

COLOURS:

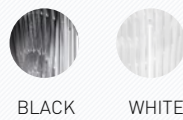

AVIA EDITION M

3 X 12W LED Filament Bulbs E27/E26
 + 1 X 7W Spot LED Bulb E27/E26
 Dimmable with dimmable bulbs
 MADE OF: Cristalflex® / Lentiflex®

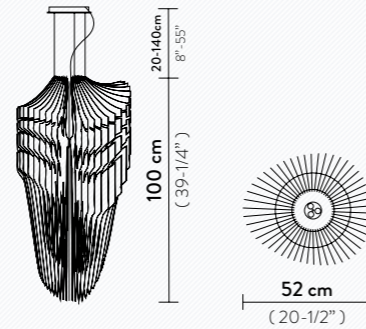

COLOURS:



BACH TABLE M

1 X 12W LED Filament Bulb E27/E26
 MADE OF: Opalflex®
 WITH: Stainless Steel base

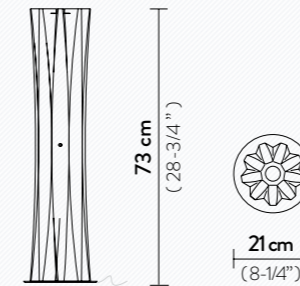

COLOURS:

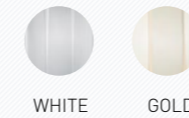

BACH TABLE S

1 X 6W LED Filament Bulb E14/E12
 MADE OF: Opalflex®
 WITH: Stainless Steel base

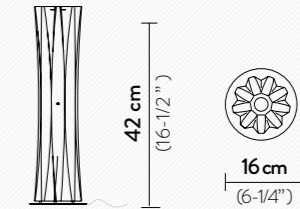

BACH FLOOR XXL

3 X 12W LED Filament Bulbs E27/E26
 MADE OF: Opalflex®
 WITH: Stainless Steel base - Dimmer

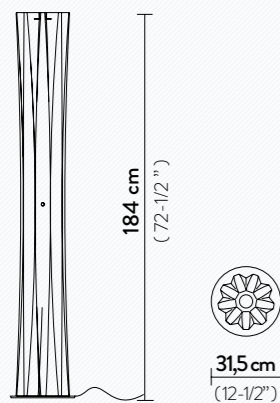

COLOURS:



BACH FLOOR XL

3 X 12W LED Filament Bulbs E27/E26
 MADE OF: Opalflex®
 WITH: Stainless Steel base - Dimmer

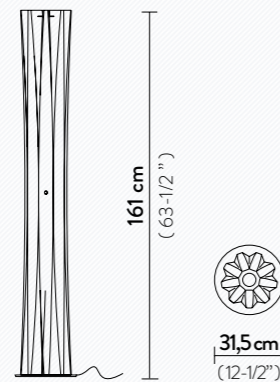

BACH FLOOR L

2 X 12W LED Filament Bulbs E27/E26
 MADE OF: Opalflex®
 WITH: Stainless Steel base

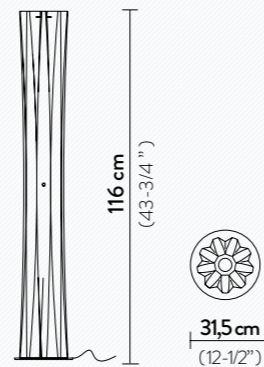

BIOS CEILING/WALL L

4 X 12W LED Filament Bulbs E27/E26
 Dimmable with dimmable bulbs
 MADE OF: Opalflex®
 WITH: Magnetic System®
 (Bayonet mount for North America)

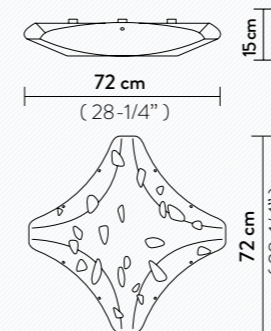

COLOURS:

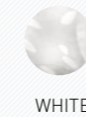

BIOS CEILING/WALL M

3 X 12W LED Filament Bulbs E27/E26
 Dimmable with dimmable bulbs
 MADE OF: Opalflex®
 WITH: Magnetic System®

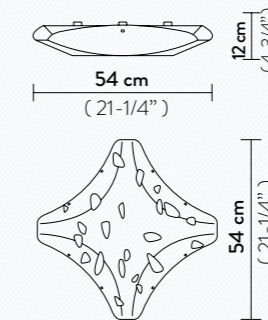

BIOS CEILING/WALL S

2 X 12W LED Filament Bulbs E27/E26
 Dimmable with dimmable bulbs
 MADE OF: Opalflex®
 WITH: Magnetic System®

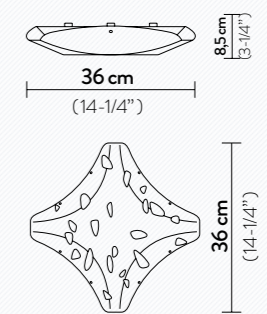

BIOS FLOOR

3 X12W LED Filament Bulbs E27/E26
MADE OF: Opalflex®
WITH: Dimmer

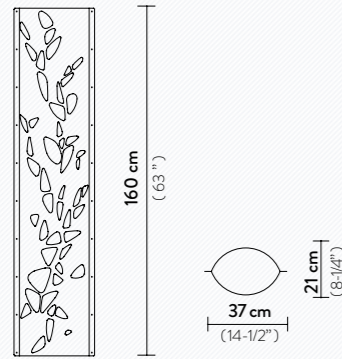

COLOURS:



WHITE

BIOS TABLE

1 X 6W LED Filament Bulb E14/E12
MADE OF: Opalflex®

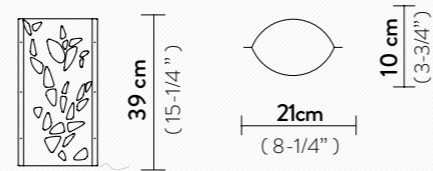

COLOURS:



WHITE

CACTUS PRISMA TABLE XM

1 X 6W LED Filament Bulb E14/E12
MADE OF: Lentiflex®
WITH: Stainless Steel base

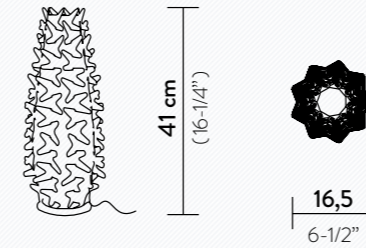

COLOURS:



PRISMA

CACTUS PRISMA TABLE XS

1 X 6W LED Filament Bulb E14/E12
MADE OF: Lentiflex®
WITH: Stainless Steel base

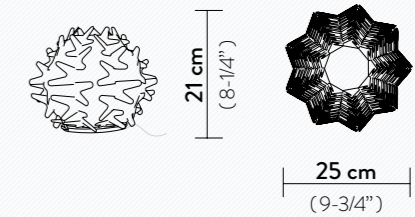

CACTUS PRISMA FLOOR XL

2 X12W LED Filament Bulbs E27/E26
MADE OF: Lentiflex®
WITH: Stainless Steel base - Dimmer

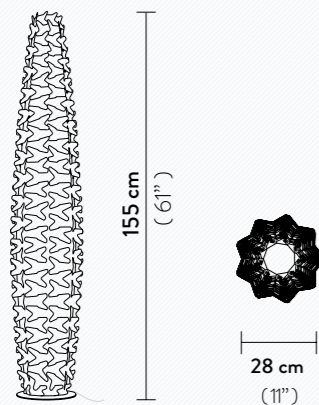

COLOURS:



PRISMA

CACTUS SUSPENSION

1 X12W LED Filament Bulbs E27/E26
Dimmable with dimmable bulbs
MADE OF: Opalflex®

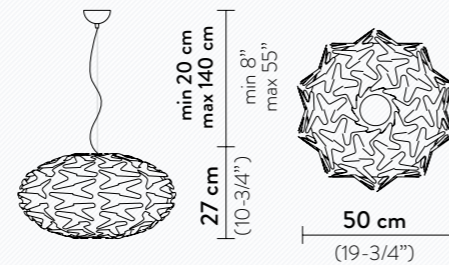

COLOURS:



GOLD

CACTUS FLOOR XXL

2 X12W LED Filament Bulbs E27/E26
MADE OF: Opalflex®
WITH: Stainless Steel base

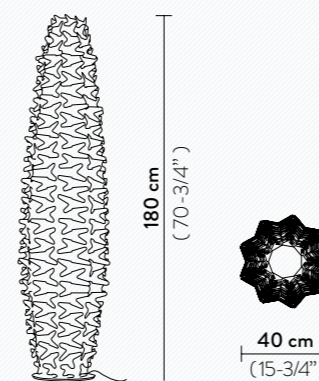

COLOURS:



GOLD

CACTUS FLOOR XL

2 X12W LED Filament Bulbs E27/E26
MADE OF: Opalflex®
WITH: Stainless Steel base

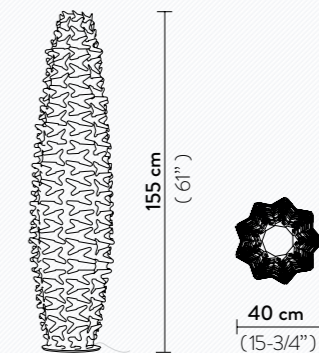

CACTUS TABLE M

1 X 6W LED Filament Bulb E14/E12
MADE OF: Opalflex®
WITH: Stainless Steel base



CACTUS TABLE S

1 X 6W LED Filament Bulb E14/E12
MADE OF: Opalflex®
WITH: Stainless Steel base

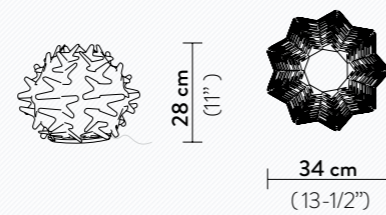

COLOURS:



GOLD

CHANTAL SUSPENSION M

7 X 12W LED Filament Bulbs E27/E26
Dimmable with dimmable bulbs
MADE OF: Cristalflex® / Lentiflex®

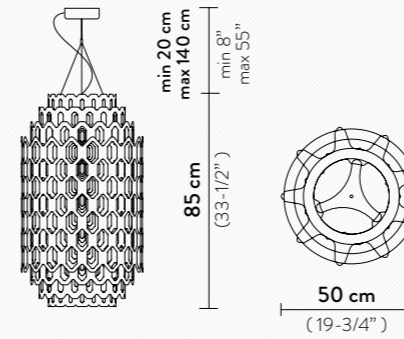

COLOURS:



ORANGE



BLUE



WHITE



MAGNETIC SYSTEM

CHANTAL SUSPENSION S

4 X 12W LED Filament Bulbs E27/E26
Dimmable with dimmable bulbs
MADE OF: Cristalflex® / Lentiflex®
WITH: Magnetic System®

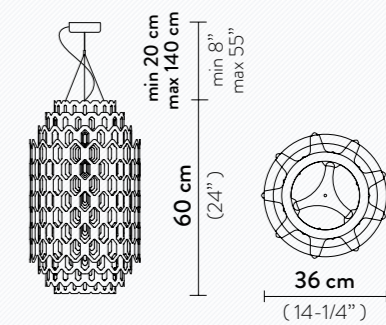

CEREMONY LARGE

4 X 12W LED Filament Bulbs E27/E26
+ 1 X 8W GU10 Spot LED Bulb E27/E26
Dimmable with dimmable bulbs
MADE OF: Lentiflex® / Cristalflex® /Opalflex®

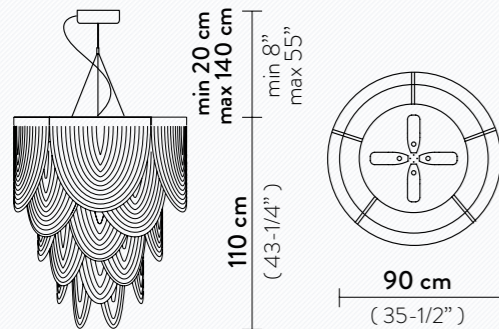

COLOURS:



PRISMA



FUMÉ



WHITE

CEREMONY SMALL

3 X 12W LED Filament Bulbs E27/E26
+ 1 X 8W GU10 Spot LED Bulb E27/E26
Dimmable with dimmable bulbs
MADE OF: Lentiflex® / Cristalflex® /Opalflex®

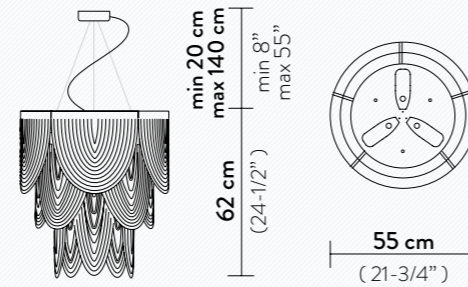

CHARLOTTE GLOBE

4 X 12W LED Filament Bulbs E27/E26
Dimmable with dimmable bulbs
MADE OF: Cristalflex® / Lentiflex®
WITH: Magnetic System®

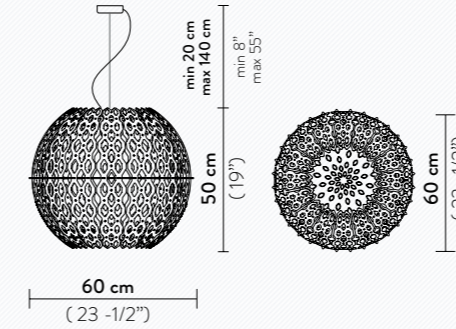

COLOURS:



WHITE



MAGNETIC SYSTEM

HALF CHARLOTTE SUSPENSION

4 X 12W LED Filament Bulbs E27/E26
Dimmable with dimmable bulbs
MADE OF: Cristalflex® / Lentiflex®

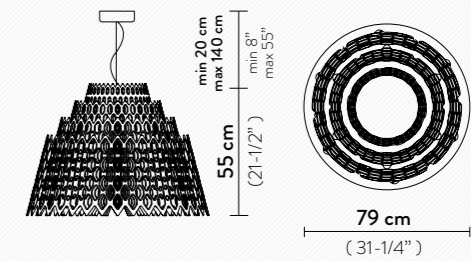

COLOURS:



WHITE

CHARLOTTE WALL LAMP

1 X 12W LED Filament Bulb E27/E26
 Dimmable with dimmable bulbs
 MADE OF: Cristalflex® / Lentiflex®

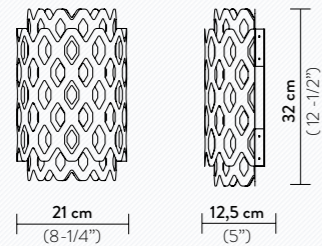

COLOURS:



WHITE

CHARLOTTE FLOOR

2 X 12W - LED Dimmable Bulbs (filament or Spot)
 E27/E26
 MADE OF: Cristalflex® / Lentiflex®
 WITH: Dimmer

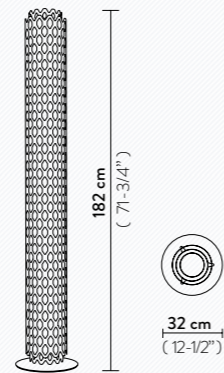

COLOURS:



WHITE

CLIZIA SUSPENSION LARGE

4 X 12W LED Filament Bulbs E27/E26
 Dimmable with dimmable bulbs
 MADE OF: Lentiflex® / Cristalflex® / Opalflex®
 WITH: Magnetic System®

Mama non Mama and Pixel with Red wrapped cable, available also with transparent cable

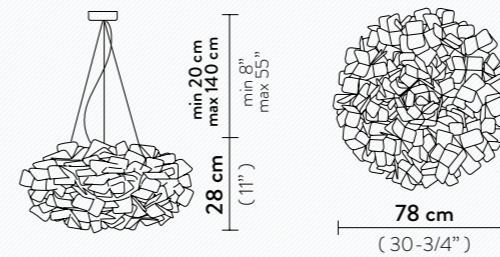

COLOURS:



MAMA NON MAMA



PIXEL



FUMÉ



BLACK



WHITE



ORANGE



PURPLE



BLUE
(only M size)



MAGNETIC SYSTEM

CLIZIA SUSPENSION

2 X 12W LED Filament Bulbs E27/E26
 Dimmable with dimmable bulbs
 MADE OF: Lentiflex® / Cristalflex® / Opalflex®
 WITH: Magnetic System®

Mama non Mama and Pixel with Red wrapped cable, available also with transparent cable

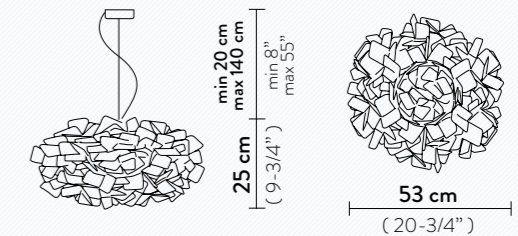

CLIZIA CEILING-WALL L

3 X 12W LED Filament Bulbs E27/E26
 Dimmable with dimmable bulbs
 MADE OF: Opalflex® / Cristalflex® / Lentiflex®
 WITH: Magnetic System®
 [Bayonet mount for North America]

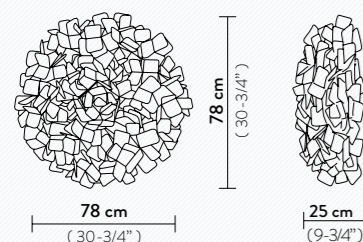

CLIZIA CEILING-WALL M

2 X 12W LED Filament Bulbs E27/E26
 Dimmable with dimmable bulbs
 MADE OF: Opalflex® / Cristalflex® / Lentiflex®
 WITH: Magnetic System®

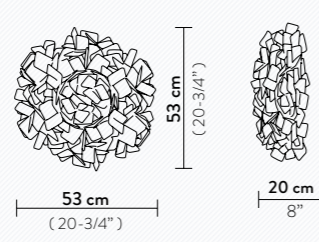

CLIZIA CEILING-WALL MINI

2 X 6W LED Filament Bulbs E14/E12
 Dimmable with dimmable bulbs
 MADE OF: Opalflex® / Cristalflex® / Lentiflex®
 WITH: Magnetic System®

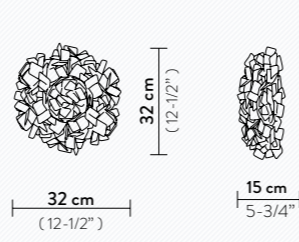

COLOURS:



MAMA NON MAMA



PIXEL



FUMÉ



BLACK



WHITE



ORANGE



PURPLE



BLUE
(only M size)



MAGNETIC SYSTEM

CLIZIA APPLIQUE

2 X 6W LED Filament Bulbs E14/E12
 Dimmable with dimmable bulbs
 MADE OF: Cristalflex®
 WITH: Magnetic System®

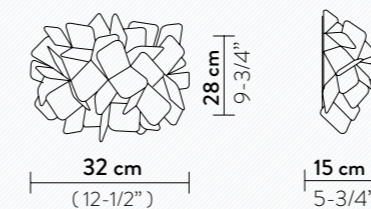

COLOURS:



MAMA NON MAMA



PIXEL



MAGNETIC SYSTEM

CLIZIA BATTERY

LED: 1.3W dimmable- 150 Lumen - 2700 Kelvin
 Rechargeable Li-ion Polymer Cell 3.7 Vdc 2500mAh Charge 5 Vdc 1A.
 BATTERY DURATION: at max intensity around 6.5 hours duration, at min intensity around 60 hours duration.
 MADE OF: Lentiflex® / Cristalflex®
 WITH: USB / DC plug included
 USB Multicharger station (20 ports) upon request

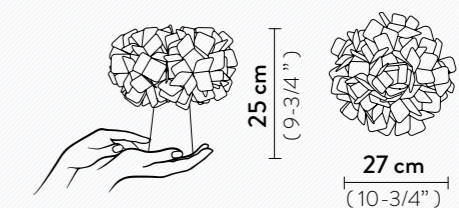

COLOURS:



MAMA NON MAMA



FUMÉ



TOUCH DIMMER



BATTERY POWERED

CLIZIA TABLE

1 X 6W LED Filament Bulb E14/E12
 MADE OF: Lentiflex® / Cristalflex®
 WITH: Magnetic System® - Coloured steel base

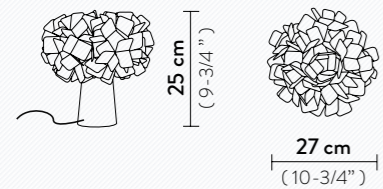

COLOURS:

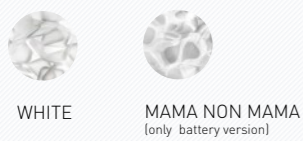
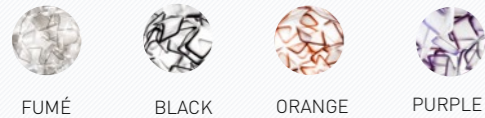

CLIZIA FLOOR

3 X 12W LED Filament Bulbs E27/E26
 MADE OF: Opalflex® / Lentiflex® / Cristalflex®
 WITH: Magnetic System®

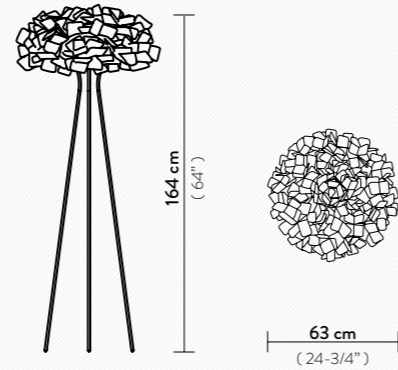

COLOURS:

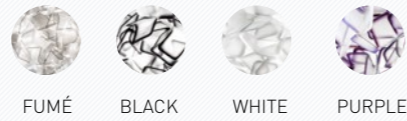

DAFNE CEILING/WALL L

4 X 12W LED Filament Bulbs E27/E26
 Dimmable with dimmable bulbs
 MADE OF: Opalflex®
 WITH: Magnetic System®
 (Bayonet mount for North America)

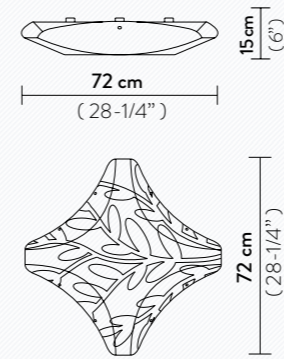

COLOURS:



DAFNE CEILING/WALL M

3 X 12W LED Filament Bulbs E27/E26
 Dimmable with dimmable bulbs
 MADE OF: Opalflex®
 WITH: Magnetic System®

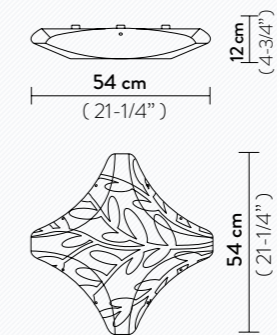

DAFNE CEILING/WALL S

2 X 12W LED Filament Bulbs E27/E26
 Dimmable with dimmable bulbs
 MADE OF: Opalflex®
 WITH: Magnetic System®

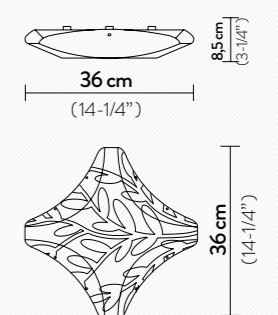

CORDOBA SUSPENSION

LED: 130W - 110-240 Vac /24 Vdc
 15.000 Lumen - 2900 Kelvin - CRI > 90
 Dimmable with: PWM / 1-10 or Potent.
 (110V-220V version)
 Additional dimming system Dali, Bluetooth,
 Casambi, Triac upon request.
 MADE OF: Cristalflex®

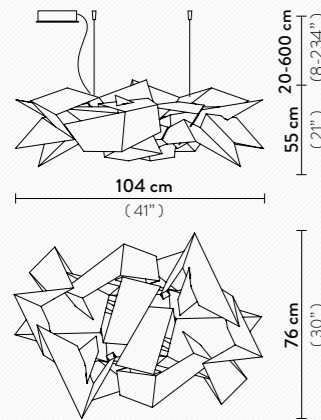

COLOURS:



DAFNE FLOOR

3 X 12W LED Filament Bulbs E27/E26
 MADE OF: Opalflex®
 WITH: Dimmer - Aluminum profiles

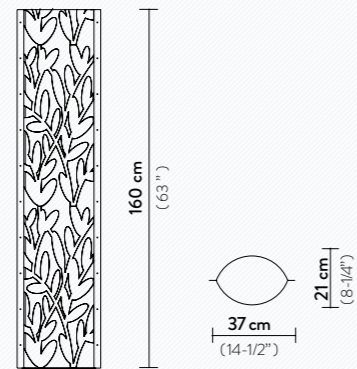

COLOURS:



DAFNE TABLE

1 X 6W LED Filament Bulb E14/E12
 MADE OF: Opalflex®

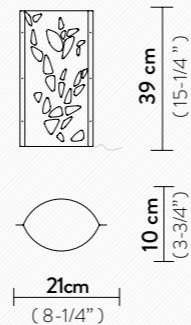

COLOURS:



DIAMOND FLOOR L

1 X 12W LED Filament Bulbs E27/E26
 MADE OF: Opalflex®
 WITH: Aluminium base

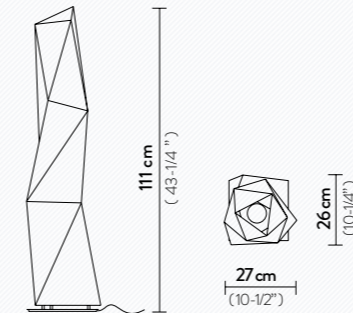

COLOURS:



DIAMOND FLOOR M

1 X 12W LED Filament Bulbs E27/E26
 MADE OF: Opalflex®
 WITH: Aluminium base

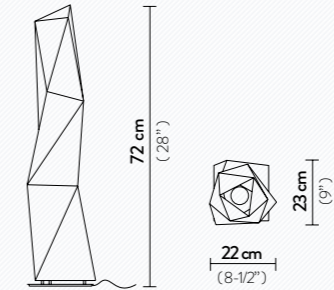

DIAMOND TABLE S

1 X 6W LED Filament Bulb E14/E12
 MADE OF: Opalflex®
 WITH: Aluminium base

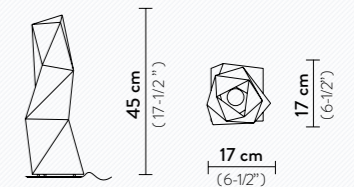

COLOURS:



DRUSA SUSPENSION

4 X 12W LED Filament Bulbs E27/E26
Dimmable with dimmable bulbs
MADE OF: Lentiflex®
WITH: Magnetic System®

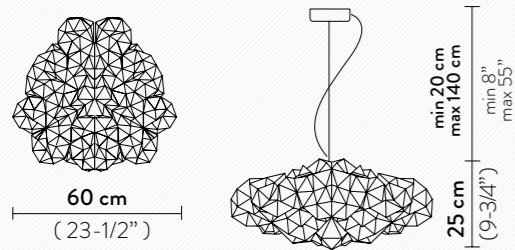

COLOURS:



WHITE VELVET



MAGNETIC SYSTEM

DRUSA CEILING - WALL

4 X 12W LED Filament Bulbs E27/E26
Dimmable with dimmable bulbs
MADE OF: Lentiflex®
WITH: Magnetic System®
(Bayonet mount for North America)

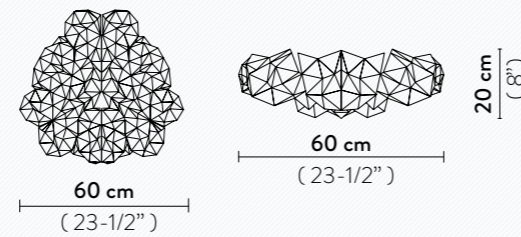

COLOURS:



WHITE VELVET



MAGNETIC SYSTEM

ÉTOILE LARGE

LED: 21W - 110-240 Vac /40 Vdc - 2830 Lumen
2700 Kelvin CRI 90
220V version dimmable with: PWM / 0-10,
110V version dimmable with: Triac Trailing Edge
Additional dimming system Dali, Bluetooth, Casambi, Triac upon request.
MADE OF: Lentiflex®
WITH: Patented LED Light Source with Magnetic System®

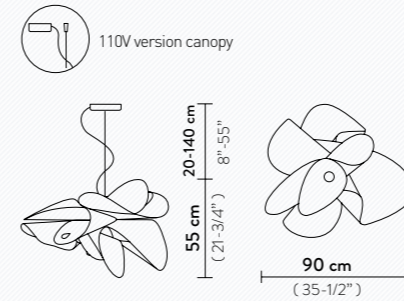

COLOURS:



PRISMA



MAGNETIC CHANGEABLE LED SOURCE

ÉTOILE

LED: 21W - 110-240 Vac /40 Vdc - 2830 Lumen
2700 Kelvin CRI 90
220V version dimmable with: PWM / 0-10,
110V version dimmable with: Triac Trailing Edge
Additional dimming system Dali, Bluetooth, Casambi, Triac upon request.
MADE OF: Lentiflex®
WITH: Patented LED Light Source with Magnetic System®

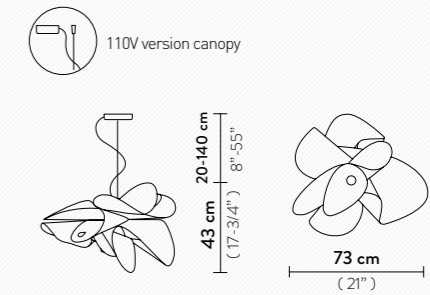

ECSTACITY FLOOR

3 X 12W LED Filament Bulbs E27/E26
MADE OF: Opalflex®
WITH: Dimmer - Aluminium profiles

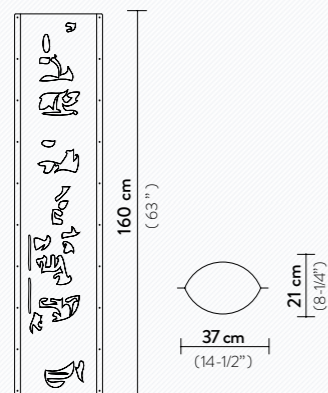

COLOURS:



WHITE

ÉTOILE CEILING / WALL

LED: 15W -200-240Vac / 40 Vdc - 2150 Lumen
2700 Kelvin - CRI 90
Dimmable with Triac Trailing Edge (110V-220V)
Additional dimming system Dali, Bluetooth, Casambi, PWM 0/10 - 1/10 upon request
MADE OF: Lentiflex®
WITH: MagneticSystem®

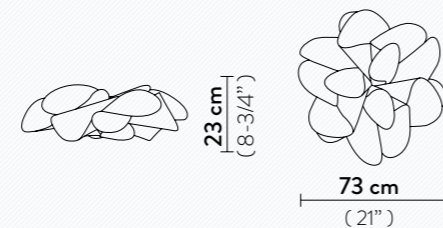

COLOURS:



PRISMA



MAGNETIC SYSTEM

FABULA SUSPENSION LARGE

5 X 12W LED Filament Bulb E27/E26
Dimmable with dimmable bulbs
MADE OF: Lentiflex®
WITH: Magnetic System®

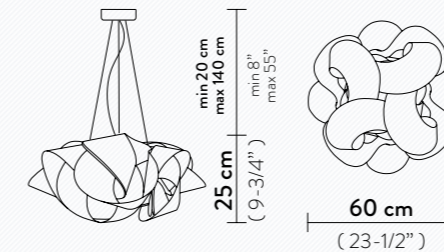

COLOURS:



PRISMA



MAGNETIC SYSTEM

FABULA SUSPENSION

3 X 12W LED Filament Bulb E27/E26
Dimmable with dimmable bulbs
MADE OF: Lentiflex®
WITH: Magnetic System®

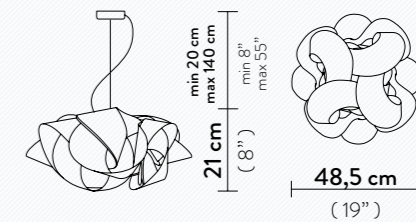

FABULA CEILING/WALL LARGE

5 X 12W LED Filament Bulb E27/E26
Dimmable with dimmable bulbs
MADE OF: Lentiflex®
WITH: Magnetic System®

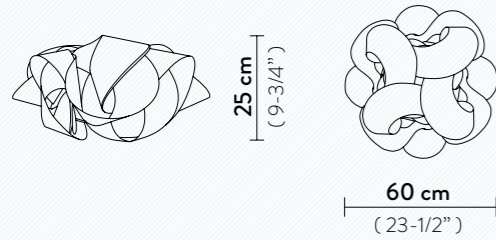

COLOURS:



PRISMA



FABULA CEILING/WALL

3 X 12W LED Filament Bulb E27/E26
Dimmable with dimmable bulbs
MADE OF: Lentiflex®
WITH: Magnetic System®

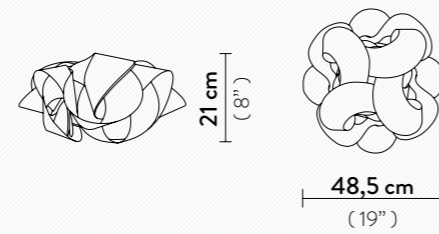

FIGURELLA SUSPENSION

1 X 12W LED Filament Bulb E27/E26
Dimmable with dimmable bulbs
MADE OF: Opalflex® / Cristalflex®

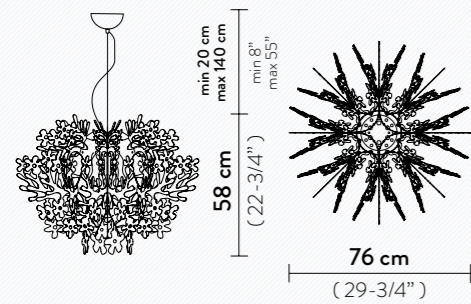

COLOURS:



WHITE

FIGURELLA SUSPENSION MINI

1 X 12W LED Filament Bulb E27/E26
Dimmable with dimmable bulbs
MADE OF: Opalflex® / Cristalflex® / Goldflex® / Steelflex® / Copperflex®

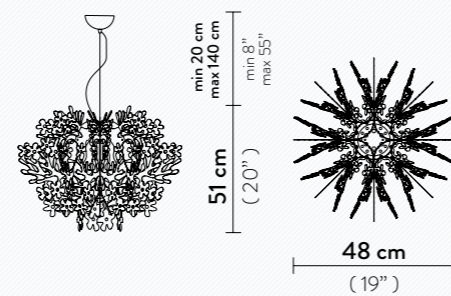

COLOURS:



WHITE



GOLD



SILVER



COPPER

FIGURELLA MINI APPLIQUE

1 X 6W LED Filament Bulbs E14/E12
Dimmable with dimmable bulbs
MADE OF: Opalflex® / Cristalflex®
WITH: Stainless Steel Support

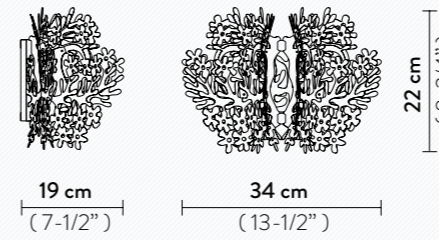

COLOURS:



WHITE

FIGURELLA TABLE

1 X 6W LED Filament Bulb E14/E12
MADE OF: Opalflex® / Cristalflex®
Goldflex® / Steelflex® / Copperflex®
WITH: Base matching colour

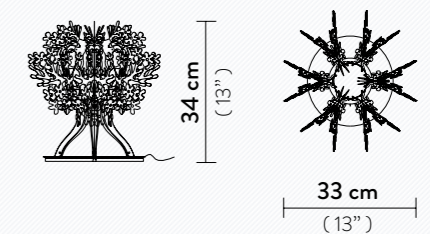

COLOURS:



WHITE



GOLD



SILVER



COPPER

FLORA FLOOR

3 X 12W LED Filament Bulbs E27/E26
MADE OF: Lentiflex® - Methacrylate
Goldflex® / Steelflex® / Copperflex® / Pewterflex®
WITH: Magnetic System®
Hand finished Sphere - Dimmer

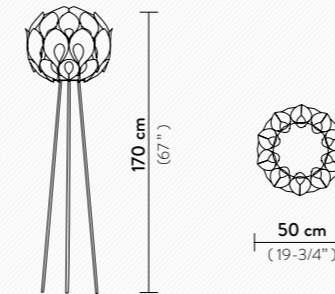

COLOURS:



WHITE



GOLD



SILVER



COPPER



PEWTER



FLORA SUSPENSION M

3 X 12W LED Filament Bulbs E27/E26
Dimmable with dimmable bulbs
MADE OF: Lentiflex® - Methacrylate
Goldflex® / Steelflex® / Copperflex® / Pewterflex®
WITH: Magnetic System®
Hand - finished Sphere

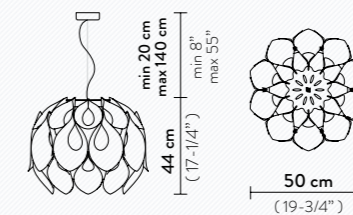

COLOURS:



WHITE



GOLD



SILVER



COPPER



PEWTER



FLORA SUSPENSION S

1 X 12W LED Filament Bulbs E27/E26
Dimmable with dimmable bulbs
MADE OF: Lentiflex® - Methacrylate
Goldflex® / Steelflex® / Copperflex® / Pewterflex®
WITH: Magnetic System®
Hand - finished Sphere

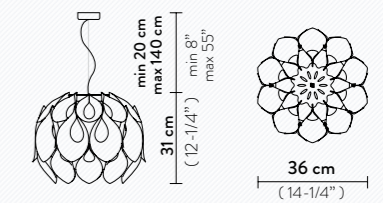

GEMMY SUSPENSION

1 X 12W LED Filament Bulb E27/E26 Dimmable with dimmable bulbs - MADE OF: Opalflex® or Lentiflex®

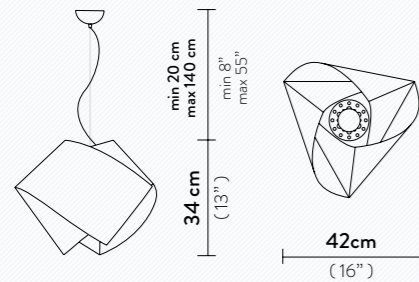

COLOURS:



GEMMY TABLE

1 X 6W LED Filament Bulb E14/E12
MADE OF: Opalflex® or Lentiflex®

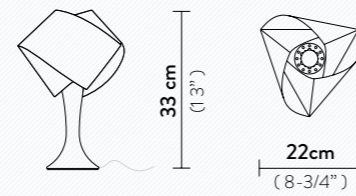

COLOURS:

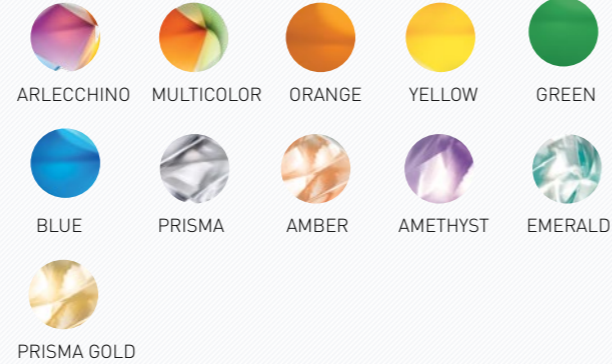

HANAMI SUSPENSION L

10 X 5W LED Dimmable Bulbs G9

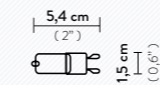

MADE OF: Lentiflex® / Polycarbonate
Stainless Steel

WITH: Red wrapped electric wire
and Bulbs included
Available also with transparent cable

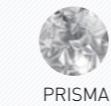
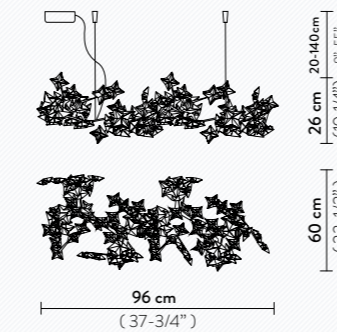

HANAMI SUSPENSION

5 X 5W LED Dimmable Bulbs G9

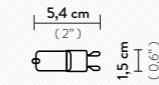

MADE OF: Lentiflex® / Polycarbonate
Stainless Steel

WITH: Red wrapped electric wire
and Bulbs included
Available also with transparent cable

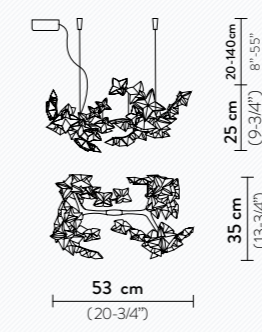

HANAMI CEILING/WALL

7 X 5W LED Dimmable Bulbs G9

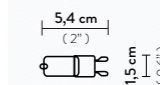

MADE OF: Lentiflex® / Polycarbonate and
Stainless Steel

WITH: Bulbs included

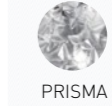
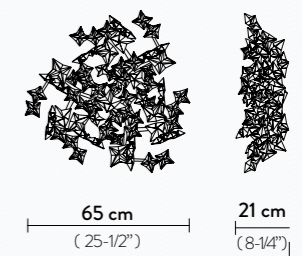

GINETTA SUSPENSION

1 X 12W LED Filament Bulb E27/E26
Dimmable with dimmable bulbs
MADE OF: Opalflex® / Cristalflex® / Steelflex® / Lentiflex®
WITH: Iridescent bulb screen and
Magnetic System® (Prisma version)

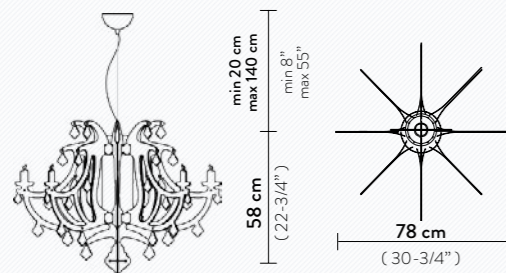

COLOURS:

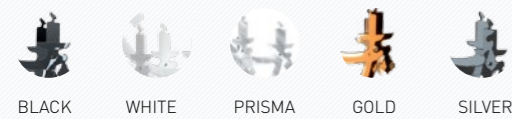

GOCCIA SUSPENSION

1 X 12W LED Filament Bulb E27/E26
Dimmable with dimmable bulbs
MADE OF: Opalflex® / Lentiflex®

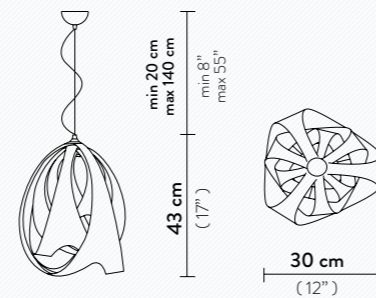

COLOURS:

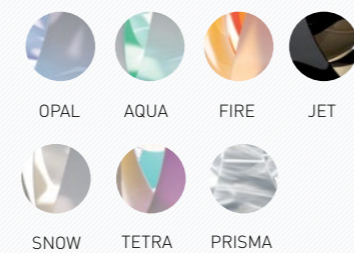

HUGO SUSPENSION

LED: 25W - 100 ~ 240 Vac /24 Vdc - 3.500 Lumen
3000 Kelvin (4000 upon request) - CRI >90
Dimmable with: PWM / 0-10 (110V-220V)
Additional dimming system Dali, Bluetooth, Casambi,
Triac upon request
MADE OF: Lentiflex®

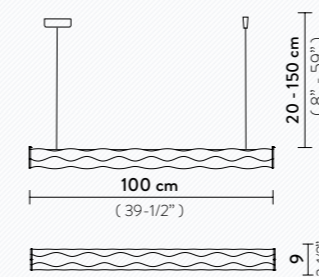

COLOURS:

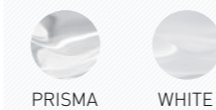

HUGO VERTICAL

LED: 25W - 100 ~ 240 Vac /24 Vdc - 3.500 Lumen
3000 Kelvin (4000 upon request) - CRI >90
Dimmable with: PWM / 0-10 (110V-220V)
Additional dimming system Dali, Bluetooth, Casambi,
Triac upon request
MADE OF: Lentiflex®

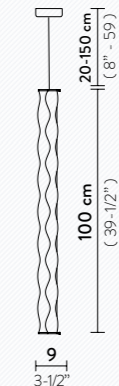

COLOURS:



HUGO ARCHITECTURAL SYSTEM

COMPONENTS:

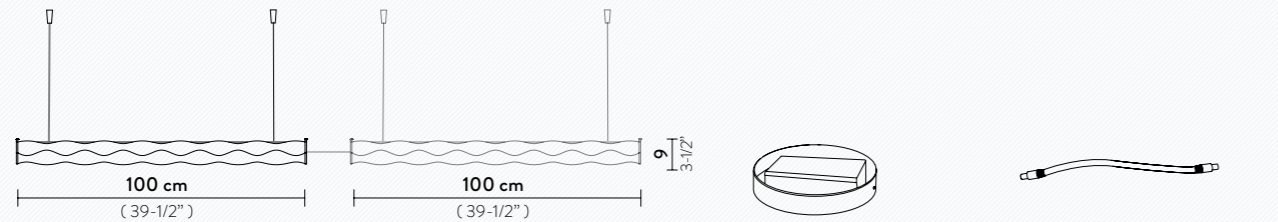

1 X HUGO MAIN
electrified module

HUGO SIDE
variable number from 1 to 6

1 X CEILING ROSE
with power supply

CONNECTION CABLES
variable number from 1 to 6

ARCHITECTURAL SYSTEM 2

40W-100~240V/24Vdc - 7000 Lumen
3000 Kelvin (4000 upon request)
Dimmable with: PWM, 0-10
(110V-220V)
Additional dimming system Dali,
Bluetooth, Casambi, Triac upon
request

ARCHITECTURAL SYSTEM 5

100W-100~240V/24Vdc-17.500 Lumen
3000 Kelvin (4000 upon request)
Dimmable with: PWM, 0-10
or Potentiometer (110V-220V)
Additional dimming system Dali,
Bluetooth, Casambi, Triac upon
request

ARCHITECTURAL SYSTEM 3

60W-100~240V / 24Vdc - 10.500 Lumen
3000 Kelvin (4000 upon request)
Dimmable with: PWM, 0-10
or Potentiometer (110V-220V)
Additional dimming system Dali,
Bluetooth, Casambi, Triac upon
request

ARCHITECTURAL SYSTEM 6

120W-100~240V/24Vdc - 21.000 Lumen
3000 Kelvin (4000 upon request)
Dimmable with: PWM, 1-10
or Potentiometer (110V-220V)
Additional dimming system Dali,
Bluetooth, Casambi, Triac upon
request

ARCHITECTURAL SYSTEM 4

80W-100~240V/24Vdc-14.000 Lumen
3000 Kelvin (4000 upon request)
Dimmable with: PWM, 0-10
or Potentiometer (110V-220V)
Additional dimming system Dali,
Bluetooth, Casambi, Triac
upon request

ARCHITECTURAL SYSTEM 7

140W-100~240V/24Vdc-24.500 Lumen
3000 Kelvin (4000 upon request)
Dimmable with: PWM, 1-10
or Potentiometer (110V-220V)
Additional dimming system Dali,
Bluetooth, Casambi, Triac upon
request

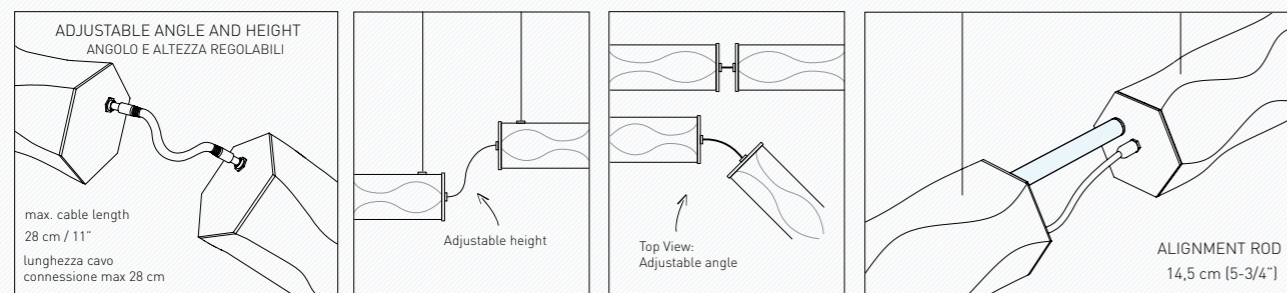

Transparent magnetic alignment rod to perfectly align
modules are available upon request

Disponibile su richiesta una barretta trasparente con
estremità magnetiche per tenere i moduli perfettamente
allineati.

COLOURS:



PRISMA

WHITE

HUGO FLOOR

LED: 40W -100~240Vac/24Vdc - 7.000 lumen
3000 Kelvin - Dimmable
MADE OF: Lentiflex® - Stainless steel
With: Integrated Dimmer

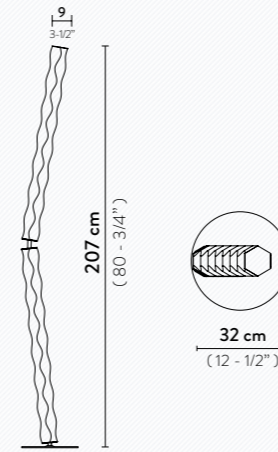

COLOURS:



PRISMA



TOUCH
DIMMER

IDEA TABLE LAMP

1 X 5W G9 LED - 500 Lumen
MADE OF: Technopolymer / Brushed Brass
WITH: Bulb included

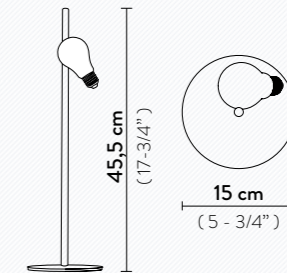
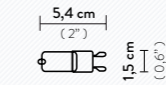

COLOURS:



BRASS

IDEA APPLIQUE

1 X 5W G9 LED Dimmable bulb - 500 Lumen
MADE OF: Technopolymer / Stainless Steel
or White coated Steel
WITH: Bulb included

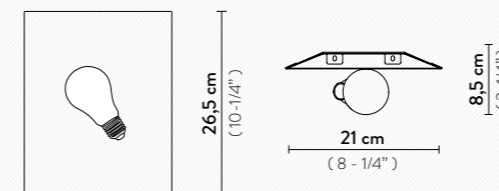
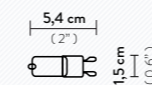

COLOURS:



MIRROR



WHITE

IDEA RECESSED WALL LAMP

1 X 5W G9 LED Dimmable bulb - 500 Lumen
MADE OF: Technopolymer /Plaster
WITH: Bulb included

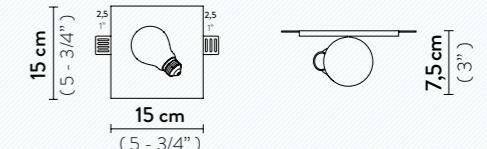
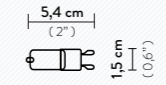

KALATOS CEILING/WALL

4 X 12W LED Filament Bulbs E27/E26
Dimmable with dimmable bulbs
MADE OF: Lentiflex® / Polycarbonate
or Metallized Polycarbonate

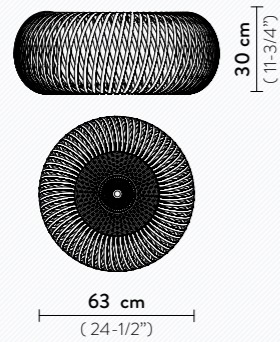

COLOURS:

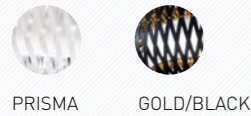

KALATOS SUSPENSION

4 X 12W LED Filament Bulbs E27/E26
Dimmable with dimmable bulbs
MADE OF: Lentiflex® / Polycarbonate
or Metallized Polycarbonate

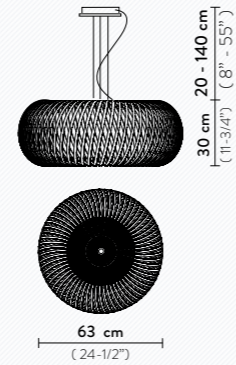

COLOURS:

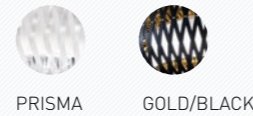

LA LOLLO XL

LED: 130W - 110-240Vac/ 24Vdc
15.000 Lumen - 2700 Kelvin - CRI >90
220V version dimmable with: PWM / 0-10 or
Potentiometer
110V version dimmable with: Triac
Additional dimming system Dali, Bluetooth,
Casambi, Triac upon request

MADE OF: Cristalflex® / Lentiflex® /
Opalflex® Brushed Goldflex® or Pewterflex®

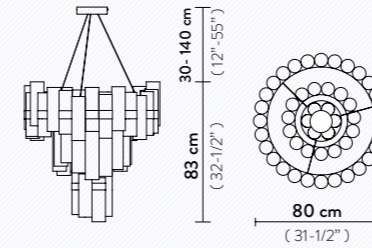

COLOURS:

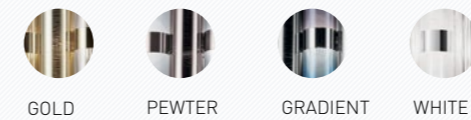

LA LOLLO L

LED: 80W - 110-240Vac/ 24Vdc
9.000 Lumen - 2700 Kelvin - CRI >90
220V version dimmable with: PWM / 0-10 or
Potentiometer
110V version dimmable with: Triac
Additional dimming system Dali, Bluetooth,
Casambi, Triac upon request

MADE OF: Cristalflex® / Lentiflex® /
Opalflex® Brushed Goldflex® or Pewterflex®

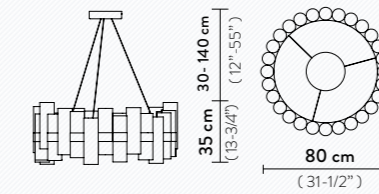

LA LOLLO M

LED: 40W - 110-240Vac/ 24Vdc
4.600 Lumen - 2700 Kelvin - CRI >90
220V version dimmable with: PWM / 0-10 or
Potentiometer
110V version dimmable with: Triac
Additional dimming system Dali, Bluetooth,
Casambi, Triac upon request

MADE OF: Cristalflex® / Lentiflex® /
Opalflex® Brushed Goldflex® or Pewterflex®

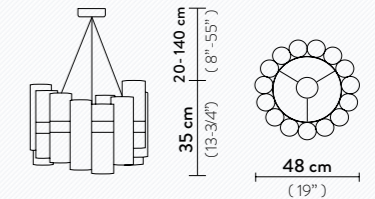

LA BELLE ÉTOILE LARGE

LED: 21W - 110-240 Vac /40 Vdc - 2830
Lumen - 2700 Kelvin CRI 90
220V version dimmable with: PWM / 0-10,
110V version dimmable with: Triac Trail. Edge
Additional dimming system Dali, Bluetooth,
Casambi, Triac upon request.
MADE OF: Lentiflex®
WITH: Patented LED Light Source
with Magnetic System®

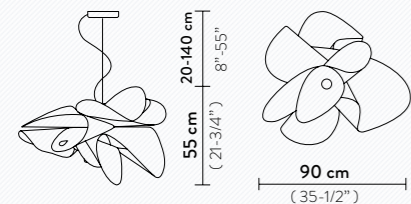

COLOURS:

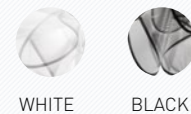

LA BELLE ÉTOILE

LED: 21W - 110-240 Vac /40 Vdc - 2830
Lumen - 2700 Kelvin CRI 90
220V version dimmable with: PWM / 0-10,
110V version dimmable with: Triac Trail. Edge
Additional dimming system Dali, Bluetooth,
Casambi, Triac upon request.
MADE OF: Lentiflex®
WITH: Patented LED Light Source
with Magnetic System®



LA BELLE ÉTOILE CEILING / WALL

LED: 15W -200-240Vac / 40 Vdc
2150 Lumen - 2700 Kelvin - CRI 90
Dimmable with Triac Trailing Edge
(220V-110V)
Additional dimming system Dali, Bluetooth,
Casambi, PWM 010 - 1/10 upon request
MADE OF: Cristalflex®
WITH: Magnetic System®



COLOURS:

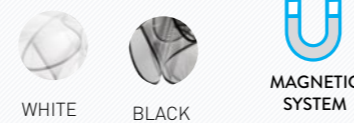

LA LOLLONA 5

LED: 390 W - 100-240Vac/ 24Vdc
44.555 Lumen - 2700 Kelvin - CRI >90
Dimmable with PWM / 0-10 or
Potentiometer (110V-220V)
Additional dimming system Dali, Casambi
upon request
MADE OF: Cristalflex® / Lentiflex® / Opalflex®
Brushed Goldflex® or Pewterflex®

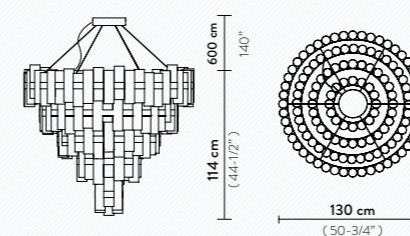

COLOURS:

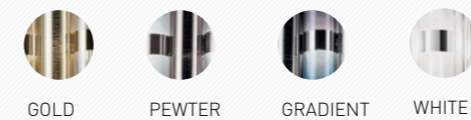

LA LOLLONA 4

LED: 242 W - 100-240Vac/ 24Vdc
28.140 Lumen - 2700 Kelvin - CRI >90
Dimmable with PWM / 0-10 or
Potentiometer (110V-220V)
Additional dimming system Dali, Casambi
upon request
MADE OF: Cristalflex® / Lentiflex® / Opalflex®
Brushed Goldflex® or Pewterflex®

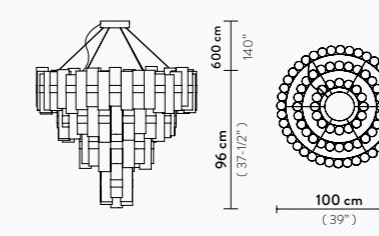

LA LOLLO APPLIQUE

2 X 6W LED Filament Bulbs E14/E12
Dimmable with dimmable bulbs
MADE OF: Cristalflex® / Lentiflex®
Opalflex® Brushed Goldflex® or
Pewterflex®
WITH: Stainless Steel Support

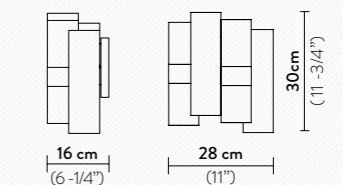

COLOURS:

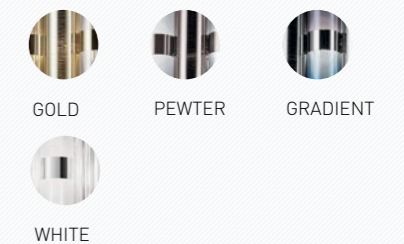

LA LOLLO FLOOR

3 X 12W LED Dimmable Filament Bulbs E27/E26

MADE OF: Cristalflex® / Lentiflex® / Steelflex® or Goldflex®

WITH: Stainless Steel Base - Dimmer

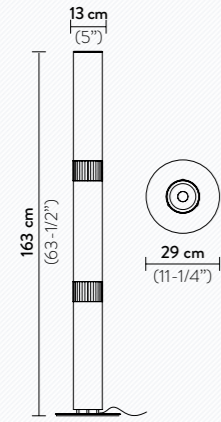

COLOURS:



LA TRAVIATA 220

13 individually dimmable RGB + 1 White LED Main Light

MAIN LED: 100W - 100-240V

7500 Lumen - 2700 Kelvin

WITH: Control System

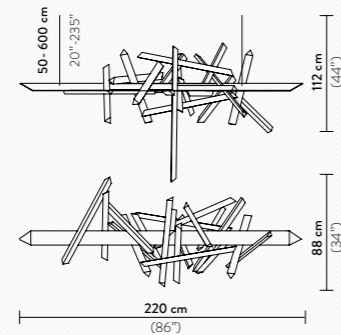

COLOURS:

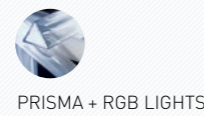

LA TRAVIATA 180

9 individually dimmable RGB + 1 White LED Main Light

MAIN LED: 100W - 100-240V

6000 Lumen - 2700 Kelvin

WITH: Control System

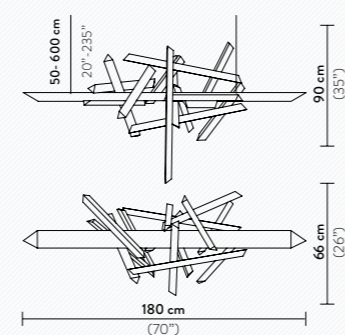

LAFLEUR BATTERY

LED: 1.3W dimmable- 150 Lumen - 2700 Kelvin
Rechargeable Li-ion Polymer Cell 3.7 Vdc 2500mAh
Charge 5 Vdc 1A.

BATTERY DURATION: at max intensity around 6.5 hours duration, at min intensity around 60 hours duration.

WITH: USB / DC Plug Included

Magnetic Base and Complementary Steel Anchor

MADE OF: Lentiflex® / Copper Wires

USB Multicharger station (20 ports) upon request

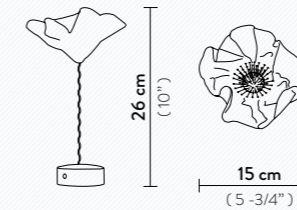

COLOURS:



LAFLEUR APPLIQUE

1 X 3W G4 LED - 450 Lumen - 2900 / 3000 Kelvin

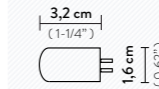

Power Supply 110-220Vac / 12 Vdc - Dimmable with Triac

Additional dimming system Dali, Bluetooth, Casambi, upon request

MADE OF: Lentiflex® / Copper Wires / Painted iron structure

WITH: Bulb included

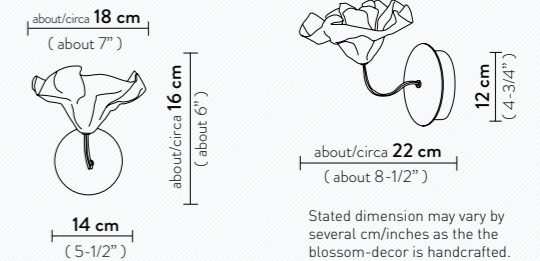

Stated dimension may vary by several cm/inches as the blossom-decor is handcrafted.

COLOURS:

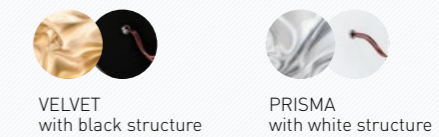

LAVIE CEILING-WALL L

3 X 12W LED Filament Bulbs E27/E26
Dimmable with dimmable bulbs

MADE OF: Opalflex® / Lentiflex®

WITH: Magnetic System®
(Bayonet mount for North America)

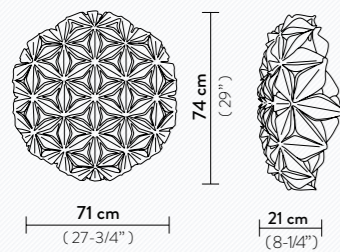

LAVIE CEILING-WALL M

2 X 12W LED Filament Bulbs E27/E26
Dimmable with dimmable bulbs

MADE OF: Opalflex® / Lentiflex®

WITH: Magnetic System®

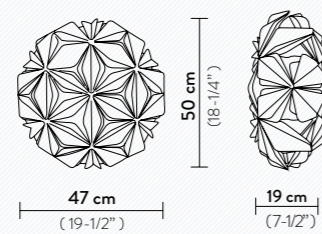

LAVIE CEILING-WALL MINI

2 X 6W LED Filament Bulbs E14/E12
Dimmable with dimmable bulbs

MADE OF: Opalflex® / Lentiflex®

WITH: Magnetic System®

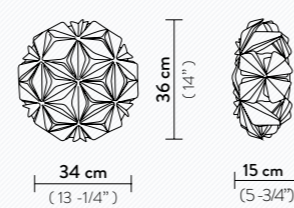

COLOURS:

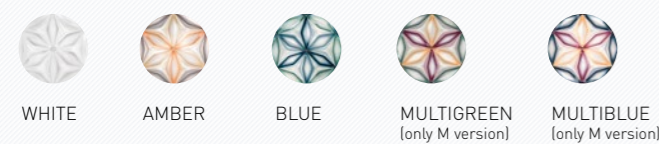

LAS PALMAS FLOOR XL

3 X 12W LED Filament Bulbs E27/E26
MADE OF: Opalflex® / Polycarbonate

WITH: Stainless Steel Base and profiles

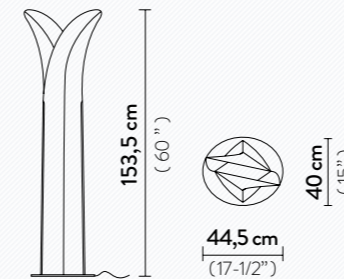

COLOURS:



LAS PALMAS FLOOR L

2 X 12W LED Filament Bulbs E27/E26
MADE OF: Opalflex® / Polycarbonate

WITH: Stainless Steel Base and profiles

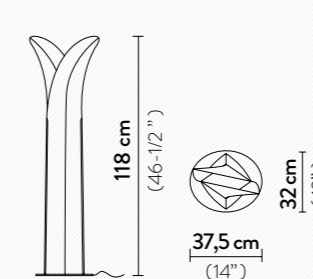

LAS PALMAS TABLE S

1 X 6W LED Filament Bulb E14/E12
MADE OF: Opalflex® / Polycarbonate

WITH: Stainless Steel Base and profiles

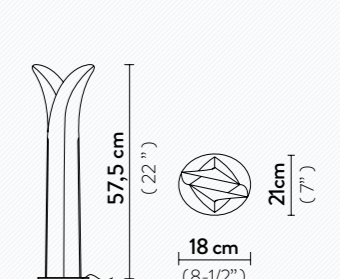

COLOURS:



LILLIBET

1 X 12W LED Filament Bulb E27/E26
Dimmable with dimmable bulbs
MADE OF: Opalflex® / Cristalflex®
Steelflex®/ Goldflex®/ Copperflex®
WITH: 56 Schöler® Crystals

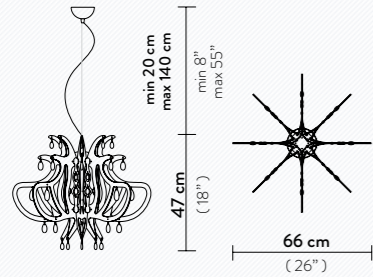

COLOURS:

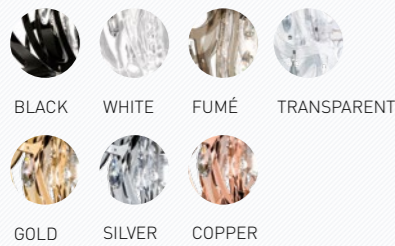

LILLIBET MINI

1 X 6W LED Filament Bulb E14/E12
Dimmable with dimmable bulbs
MADE OF: Opalflex® / Cristalflex®
WITH: 42 Schöler® Crystals

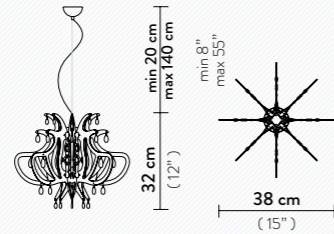

COLOURS:

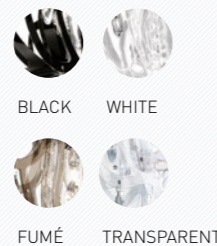

LILLIBET MINI WALL

1 X 6W LED Filament Bulb E14/E12
Dimmable with dimmable bulbs
MADE OF: Opalflex® / Cristalflex®
WITH: 26 Schöler® Crystals

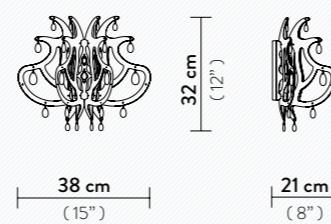

COLOURS:

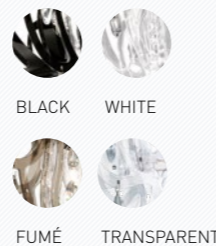

MEDUSA SUSPENSION

1 X 12W LED Filament Bulbs E27/E26
Dimmable with dimmable bulbs
MADE OF: Opalflex® / Cristalflex®
Pewterflex®
WITH: 56 Crystals

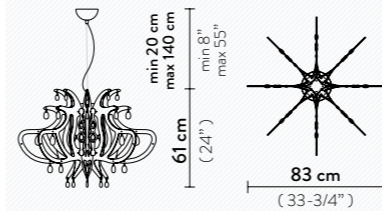

COLOURS:



MEDUSA APPLIQUE

1 X 12W LED Filament Bulb E27/E26
Dimmable with dimmable bulbs
MADE OF: Opalflex® / Cristalflex®
Pewterflex®
WITH: 26 Crystals

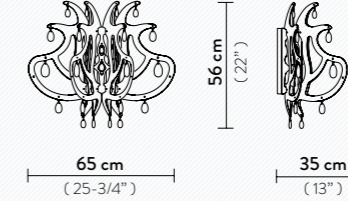

COLOURS:

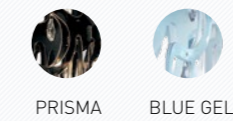

MIDA APPLIQUE

2 X 6W LED Filament Bulbs E14/E12
Dimmable with dimmable bulbs
MADE OF: Opalflex® / Lentiflex® /
Steelflex® Copperflex® / Brushed
Goldflex®
WITH: Magnetic System®

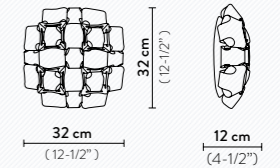

COLOURS:



LIZA TABLE

1 X 12W LED Filament Bulbs E27/E26
BASE LED: 1 X 2,5W G9 LED
MADE OF: Lentiflex® or Pewterflex®
Polycarbonate and Cristalflex®
WITH: 2 Positions light switch
Courtesy base LED bulb included

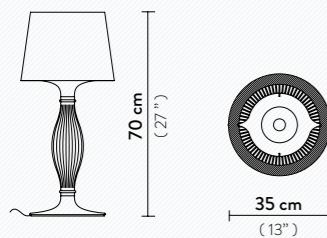

COLOURS:



LIZA SUSPENSION

1 X 12W LED Filament Bulbs E27/E26
Dimmable with dimmable bulbs
MADE OF: Lentiflex®

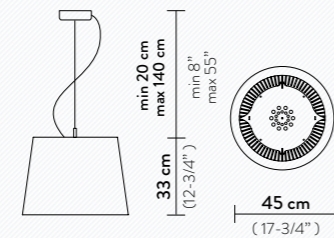

COLOURS:

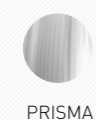

LUIS SUSPENSION

1 X 12W LED Filament Bulb E27/E26
Dimmable with dimmable bulbs
MADE OF: Lentiflex® / Opalflex®

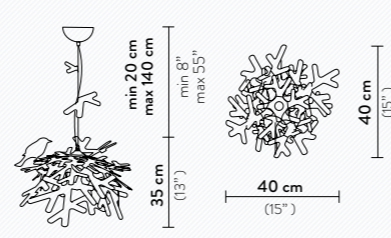

COLOURS:

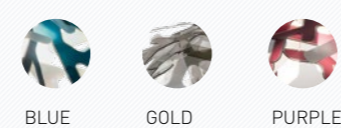

MIDA CEILING-WALL L

4 X 12W LED Filament Bulbs E27/E26
Dimmable with dimmable bulbs
MADE OF: Opalflex® / Lentiflex® /
Steelflex® Copperflex® / Brushed
Goldflex®
WITH: Magnetic System®

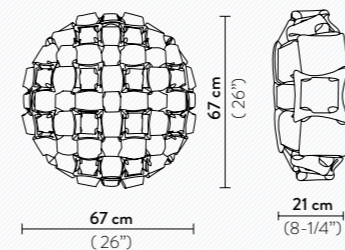

COLOURS:

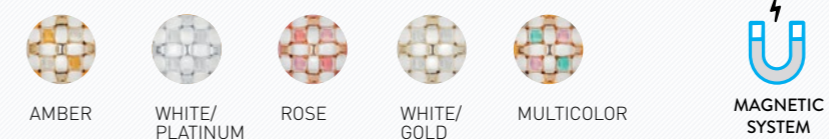

MIDA CEILING-WALL M

3 X 12W LED Filament Bulbs E27/E26
Dimmable with dimmable bulbs
MADE OF: Opalflex® / Lentiflex® /
Steelflex® Copperflex® / Brushed
Goldflex®
WITH: Magnetic System®

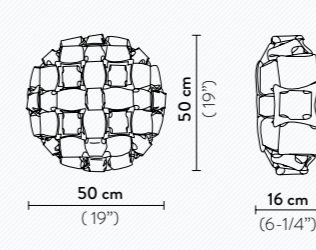

MOON TABLE

1 X 12W LED Filament Bulbs E27/E26
MADE OF: Opalflex®
WITH: Aluminium profiles brass finish,
Digital Marble Texture

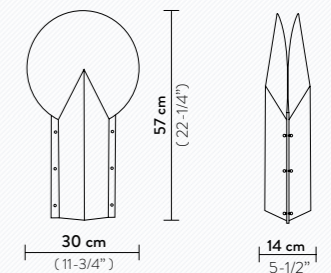

COLOURS:

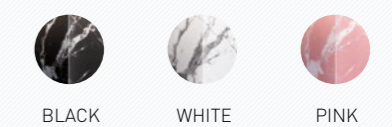

NUVEM MODULAR

2 X 8W LED GU10
 Bidirectional Spot Light
 MADE OF: Opalflex® / Lentiflex®

- >> Modules of 1 sq. meter can be joined in infinite combinations;
- >> Moduli da 1 mq componibili all'infinito.
- >> Available additional modules without spotlight
- >> Disponibili moduli aggiuntivi senza spotlight

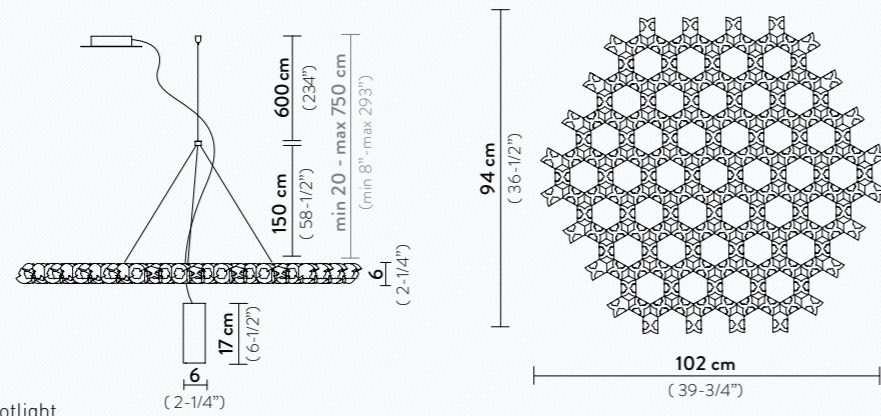

ADDITIONAL SUSPENSION SPOTLIGHT

2 X 8W LED GU10 - Bidirectional Spot Light
 MADE OF: Steel - white RAL 9016 (white version)
 Steel - Brushed Brass finish (velvet version)
 WHIT: 6 m electric wires
 6 m steel cable
 >> GU10 bulbs on request

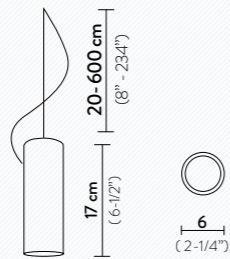

WIRE CEILING ANCHOR INCLUDED



ADDITIONAL CEILING/WALL SPOTLIGHT

1 X 8W LED GU10 - Unidirectional Spot Light
 MADE OF: Steel - white RAL 9016
 >> GU10 bulb on request

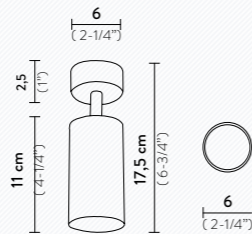

NUVEM CANOPY

Canopy max 6 electric wires
 Coppetta con alloggiamento di max 6 cavi
 MADE OF: Steel - white RAL 9016

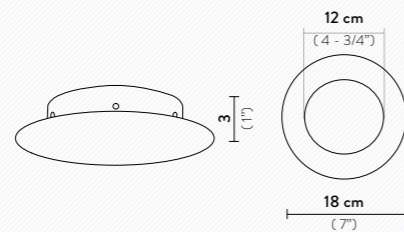

THE CANOPY FITS FROM 1 TO 6 MODULES

MODULE COLOUR



BIDIRECTIONAL SUSP. SPOTLIGHT



CANOPY AND CEILING SPOT AND ANCHOR



ODEON 100 CEILING

12 X 12W LED Filament Bulbs E27/E26
 + 1 X 6,5W Spot LED E27/E26
 Dimmable with dimmable bulbs
 MADE OF: Lentiflex® / Goldflex®

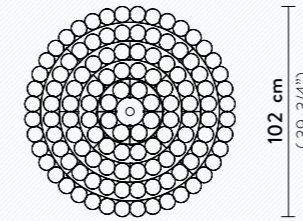
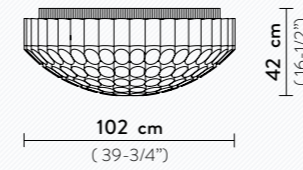

ODEON 65 CEILING

6 X 12W LED Filament Bulbs E27/E26
 + 1 X 6,5W Spot LED E27/E26
 Dimmable with dimmable bulbs
 MADE OF: Lentiflex® / Goldflex®

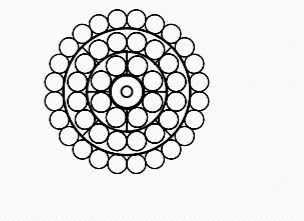
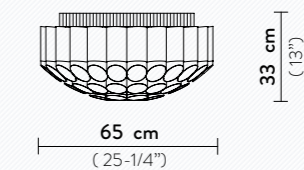

COLOURS:



GOLD

OVERLAY TABLE

Shade LED: 4W - 24Vdc - 500 Lumen - 2700 Kelvin - CRI >90
 Base LED: 1,5W - 24Vdc - 90 Lumen - 2700 Kelvin - CRI >90
 Made of: Brass, Brushed Copperflex® and Lentiflex®
 WITH: LED courtesy light in the base, independent from the principle light source and Montblanc Meisterstück Legrand writing instrument

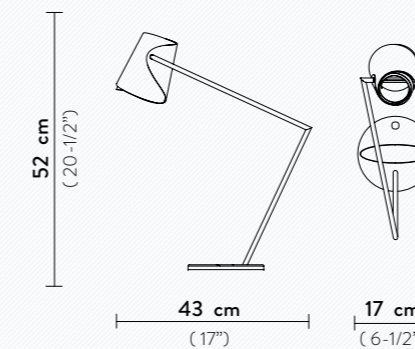

AVAILABLE WITH MONTBLANC WRITING INSTRUMENT

1 - Meisterstück LeGrand Fountain Pen Gold-Coated

2 - Meisterstück LeGrand Ballpoint Pen Gold-Coated



COLOURS:



BRASS



2 INDEPENDENT LIGHT SOURCES

SUPERMORGANA

1 X 5W LED Bulb G9

Dimmable with dimmable bulbs

MADE OF: Metallized Polycarbonate

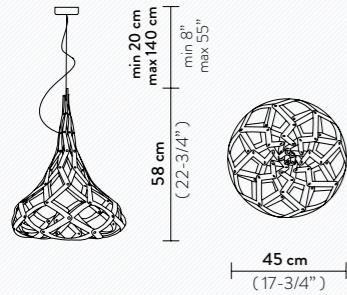

COLOURS:



GOLD/BLACK



MIRROR/BLACK

THE LIGHTNING ARCHIVES FLOOR

3 X 12W LED Filament Dimmable Bulbs E27/E26

MADE OF: Cristalflex® / Opalflex®

WITH: Dimmer - Brass or Coloured finish profiles

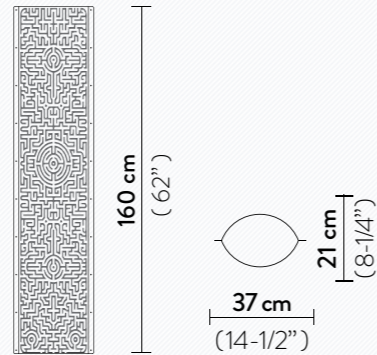

COLOURS:



FAENA



L'AFRIQUE



BANANAS



LABYRINTH



PEACE SKULL



PERISHED



LOVE PEACE JOY

TULIP 7 ROUND SUSPENSION

7 X 5W G4 LED Dimmable Bulbs - 3500 Lumen - 2900 Kelvin

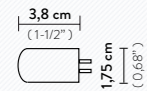

Power Supply: 110-220Vac / 24Vdc - Dimmable with: PWM / 0-10
Additional dimming system Dali, Bluetooth, Casambi upon request
MADE OF: Lentiflex® / Matte Brushed Brass
WITH: Bulbs included - Matte Brushed Brass finish canopy and copper electric wire

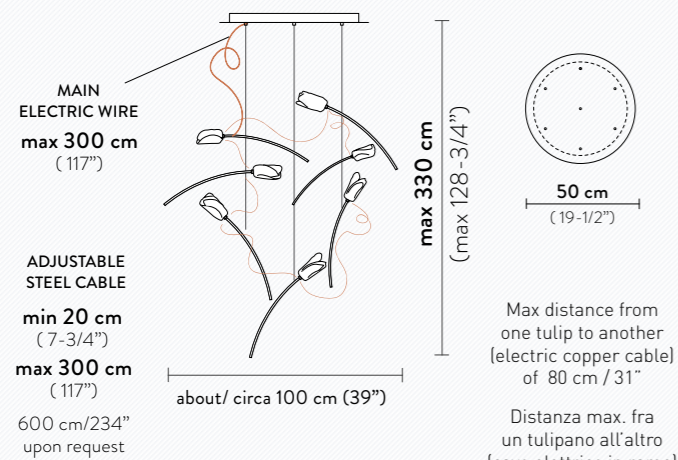

TULIP 14 ROUND SUSPENSION

14 X 5W G4 LED Dimmable Bulbs - 7000 Lumen - 2900 Kelvin

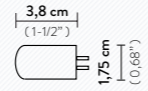

Power Supply: 110-220Vac / 24Vdc - Dimmable with: PWM / 0-10
Additional dimming system Dali, Bluetooth, Casambi upon request
MADE OF: Lentiflex® / Matte Brushed Brass
WITH: Bulbs included - Matte Brushed Brass finish canopy and copper electric wire

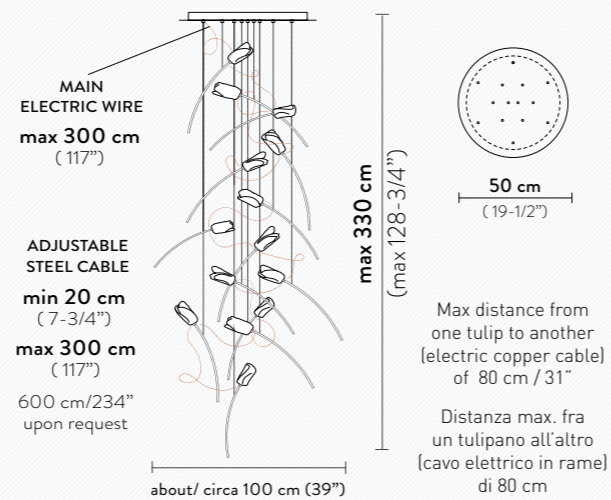

TULIP 7 LINEAR SUSPENSION

7 X 5W G4 LED Dimmable Bulbs - 3500 Lumen - 2900 Kelvin

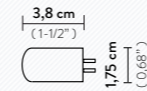

Power Supply: 110-220Vac / 24Vdc - Dimmable with: PWM / 0-10
Additional dimming system Dali, Bluetooth, Casambi upon request
MADE OF: Lentiflex® / Matte Brushed Brass
WITH: Bulbs included - Matte Brushed Brass finish canopy and copper electric wire

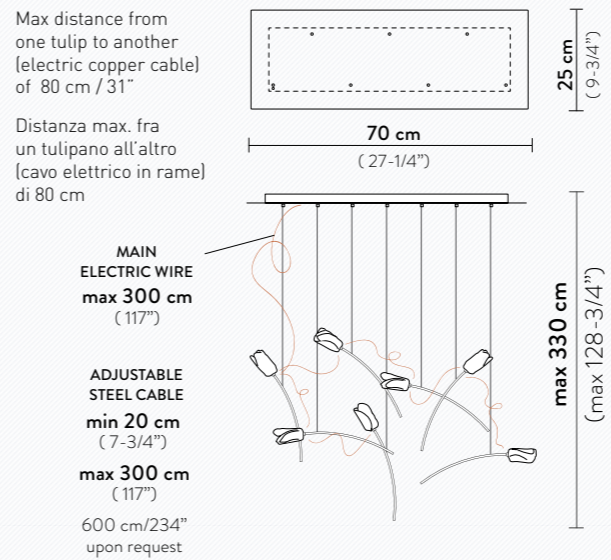

TULIP 14 LINEAR SUSPENSION

14 X 5W G4 LED Dimmable Bulbs - 7000 Lumen - 2900 Kelvin

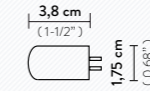

Power Supply: 110-220Vac / 24Vdc - Dimmable with: PWM / 0-10
Additional dimming system Dali, Bluetooth, Casambi upon request
MADE OF: Lentiflex® / Matte Brushed Brass
WITH: Bulbs included - Matte Brushed Brass finish canopy and copper electric wire

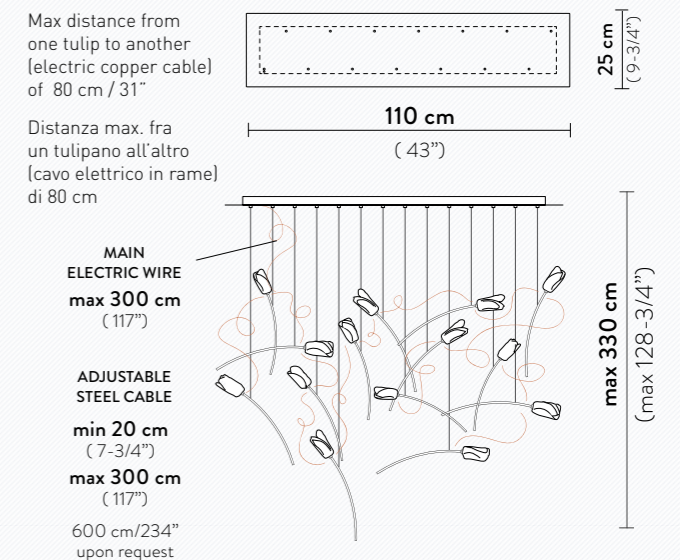

TULIP 7 ROUND SUSPENSION

7 X 5W G4 LED Dimmable Bulbs - 3500 Lumen - 2900 Kelvin

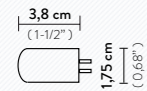

Power Supply: 110-220Vac / 24Vdc - Dimmable with: PWM / 0-10
Additional dimming system Dali, Bluetooth, Casambi upon request
MADE OF: Lentiflex® / Matte Brushed Brass
WITH: Bulbs included - Matte Brushed Brass finish canopy and copper electric wire

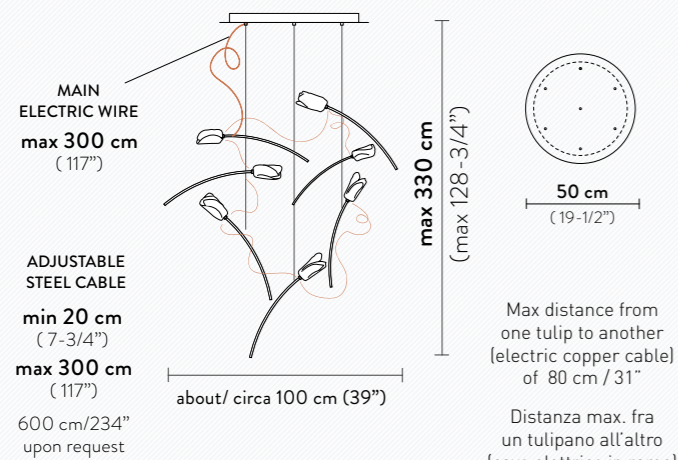

TULIP 14 ROUND SUSPENSION

14 X 5W G4 LED Dimmable Bulbs - 7000 Lumen - 2900 Kelvin

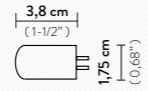

Power Supply: 110-220Vac / 24Vdc - Dimmable with: PWM / 0-10
Additional dimming system Dali, Bluetooth, Casambi upon request
MADE OF: Lentiflex® / Matte Brushed Brass
WITH: Bulbs included - Matte Brushed Brass finish canopy and copper electric wire

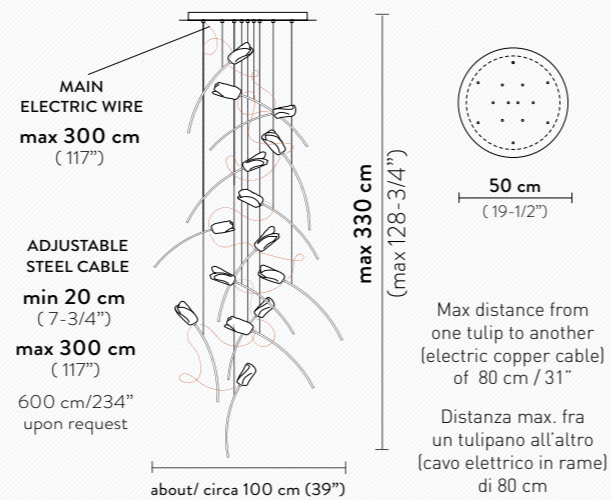

TULIP 14 FREE-STANDING SUSPENSION

14 X 5W G4 LED Dimmable Bulbs - 7000 Lumen - 2900 K

Power Supply: 110-220Vac / 24Vdc

Dimmable with: PWM / 0-10

Additional dimming system Dali, Bluetooth, Casambi upon request

MADE OF: Lentiflex® / Matte Brushed Brass

WITH: Bulbs included - Matte Brushed Brass finish canopy and copper electric wire

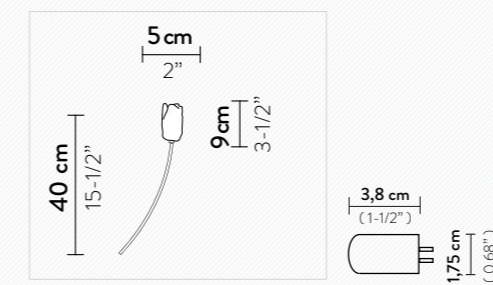

PRISMA/BRASS

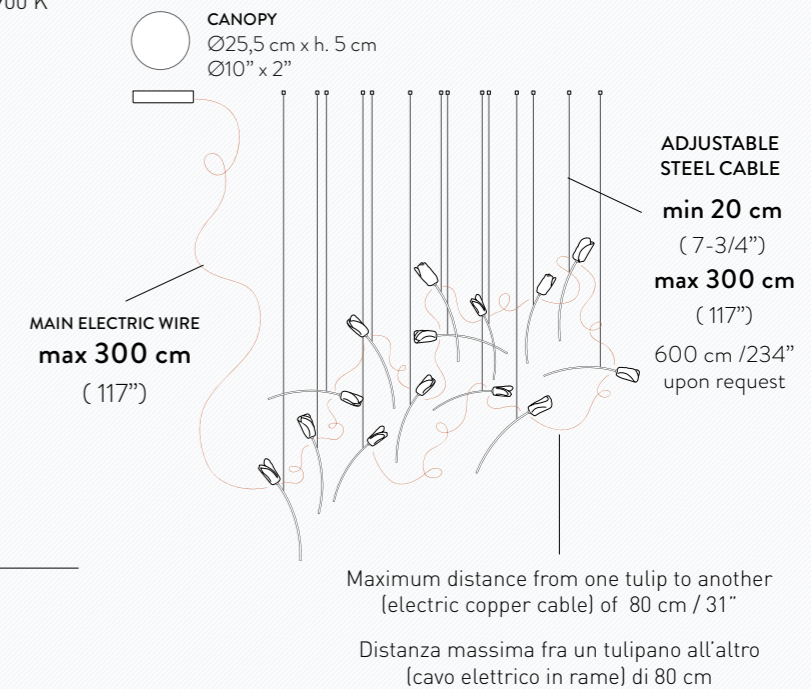

VELI SUSPENSION L

4 X12W LED Filament Bulbs E27/E26
Dimmable with dimmable bulbs
MADE OF: Opalflex® / Lentiflex® / Steelflex®
Goldflex® / Copperflex®
WITH: Magnetic System®

Couture with Red wrapped cable, available also with transparent cable

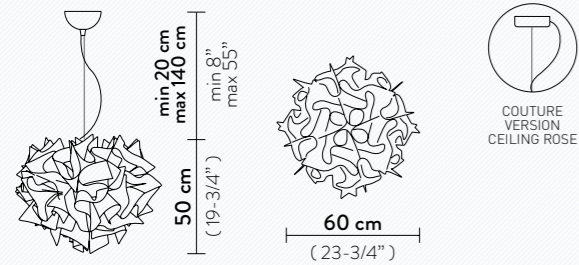

COLOURS:

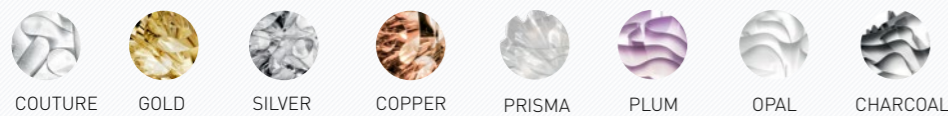

VELI SUSPENSION

2 X12W LED Filament Bulbs E27/E26
Dimmable with dimmable bulbs
MADE OF: Opalflex® / Lentiflex® / Steelflex®
Goldflex® / Copperflex®
WITH: Magnetic System®

Couture with Red wrapped cable, available also with transparent cable

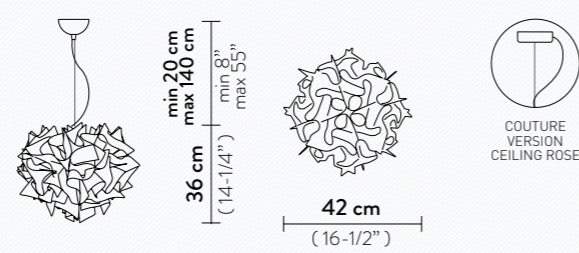

VELI CEILING-WALL L

3 X 12W LED Filament Bulbs E27/E26
Dimmable with dimmable bulbs
MADE OF: Opalflex® / Lentiflex®
Steelflex® / Goldflex® / Copperflex®
WITH: Magnetic System®

[Bayonet mount for North America]

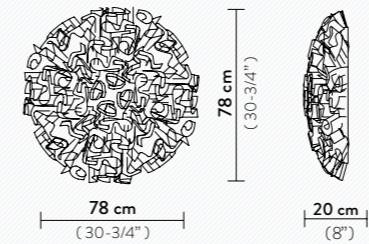

COLOURS:



VELI CEILING-WALL M

2 X 12W LED Filament Bulbs E27/E26
Dimmable with dimmable bulbs
MADE OF: Opalflex® / Lentiflex®
Steelflex® / Goldflex® / Copperflex®
WITH: Magnetic System®

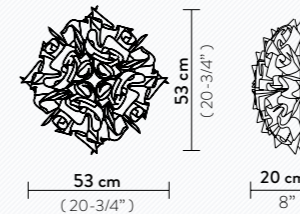

COLOURS:

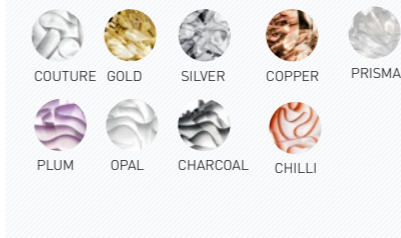

VELI CEILING-WALL MINI

2 X 6W LED Filament Bulbs E14/E12
Dimmable with dimmable bulbs
MADE OF: Opalflex® / Lentiflex®
Steelflex® / Goldflex® / Copperflex®
WITH: Magnetic System®

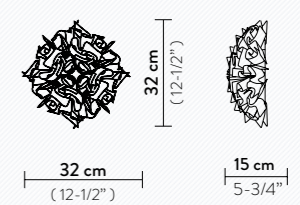

COLOURS:



VELI MINI SINGLE

1X 12W LED Filament Bulb E27/E26
Dimmable with dimmable bulbs
MADE OF: Opalflex®
WITH: Magnetic System®

Red wrapped cable, available also with transparent cable

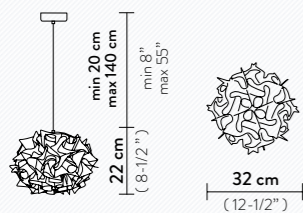

COLOURS:



VELI MINI TRIO

3 X 12W LED Filament Bulbs E27/E26
Dimmable with dimmable bulbs
MADE OF: Opalflex®
WITH: Magnetic System®

Red wrapped cable, available also with transparent cable

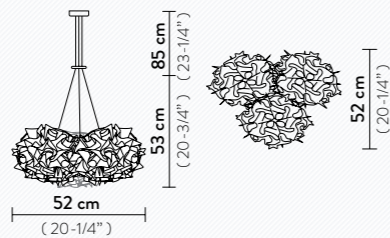

COLOURS:



VELI MINI QUARTET

4 X 12W LED Filament Bulbs E27/E26
Dimmable with dimmable bulbs
MADE OF: Opalflex®
WITH: Magnetic System®

Red wrapped cable, available also with transparent cable

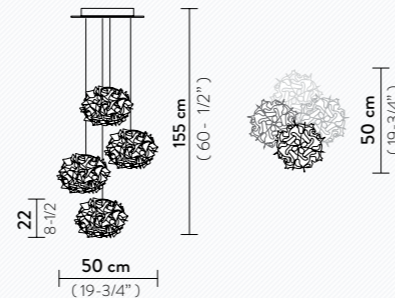

COLOURS:



VELI TABLE

1 X 6W LED Filament Bulbs E14/E12
MADE OF: Opalflex® / Metacrylate base
WITH: Magnetic System®

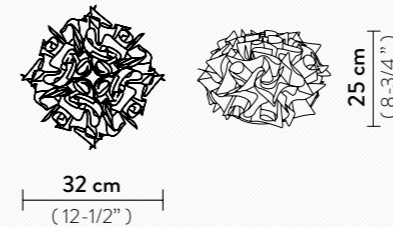

COLOURS:

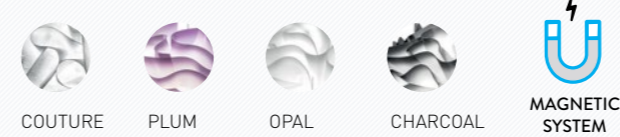

VELI 7

9 X 12W LED Filament Bulbs E27/E26
Dimmable with dimmable bulbs
MADE OF: Opalflex®
WITH: Magnetic System®

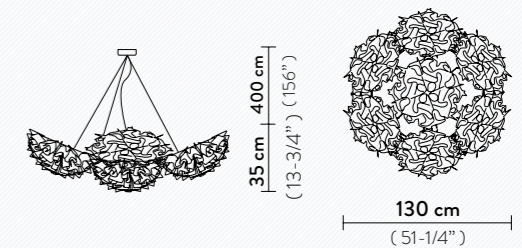

COLOURS:

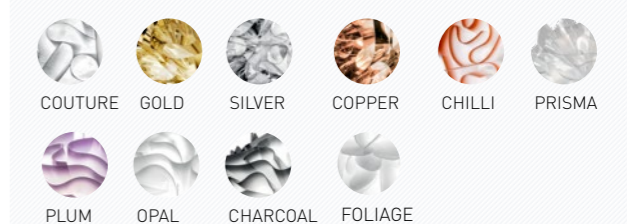

VELI SUSPENSION FOLIAGE L

4 X 12W LED Filament Bulbs E27/E26

Dimmable with dimmable bulbs

MADE OF: Opalflex®

WITH: Magnetic System®

Couture with Red wrapped cable, available also with transparent cable

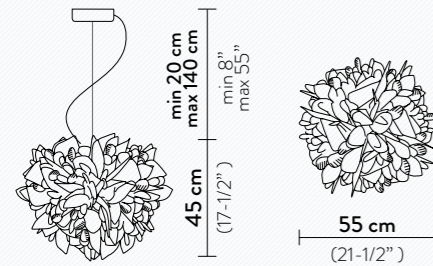

VELI SUSPENSION FOLIAGE

2 X 12W LED Filament Bulbs E27/E26

Dimmable with dimmable bulbs

MADE OF: Opalflex®

WITH: Magnetic System®

Couture with Red wrapped cable, available also with transparent cable

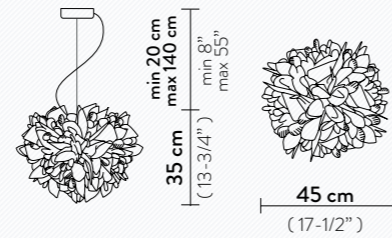

COLOURS:



FOLIAGE



MAGNETIC SYSTEM

VELI TABLE FOLIAGE

1 X 6W LED Filament Bulbs E14/E12

MADE OF: Opalflex® / Metacrylate base

WITH: Magnetic System®



COLOURS:



FOLIAGE



MAGNETIC SYSTEM

VENTI TABLE

1 X 6W LED Filament Bulb E14/E12

MADE OF: Opalflex®

WITH: Aluminum profiles

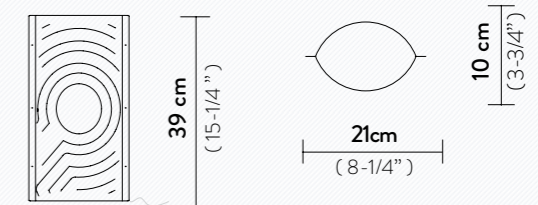

COLOURS:



WHITE

VELI CEILING-WALL FOLIAGE L

3 X 12W LED Filament Bulbs E27/E26

Dimmable with dimmable bulbs

MADE OF: Opalflex®

WITH: Magnetic System®
(Bayonet mount for North America)

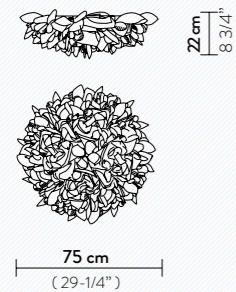

VELI CEILING-WALL FOLIAGE M

2 X 12W LED Filament Bulbs E27/E26

Dimmable with dimmable bulbs

MADE OF: Opalflex®

WITH: Magnetic System®

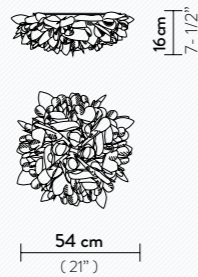

VELI CEILING-WALL FOLIAGE MINI

2 X 6W LED Filament Bulbs E14/E12

Dimmable with dimmable bulbs

MADE OF: Opalflex®

WITH: Magnetic System®

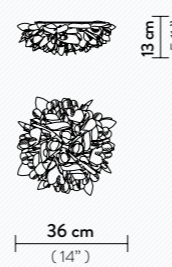

COLOURS:



FOLIAGE



MAGNETIC SYSTEM

COLOURS:



FOLIAGE



MAGNETIC SYSTEM

COLOURS:



FOLIAGE



MAGNETIC SYSTEM

VENTI CEILING/WALL L

4 X 12W LED Filament Bulbs E27/E26

Dimmable with dimmable bulbs

MADE OF: Opalflex®

WITH: Magnetic System®
(Bayonet mount for North America)

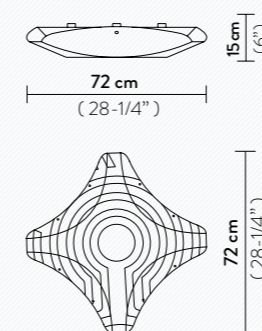

VENTI CEILING/WALL M

3 X 12W LED Filament Bulbs E27/E26

Dimmable with dimmable bulbs

MADE OF: Opalflex®

WITH: Magnetic System®

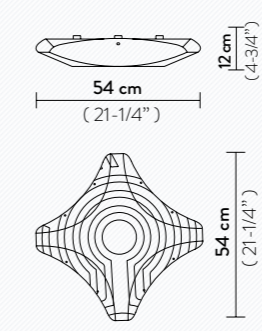

VENTI CEILING/WALL S

2 X 12W LED Filament Bulbs E27/E26

Dimmable with dimmable bulbs

MADE OF: Opalflex®

WITH: Magnetic System®

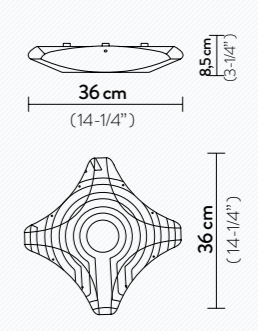

COLOURS:



WHITE



MAGNETIC SYSTEM

VENTI FLOOR

3 X 12W LED Filament Bulbs E27/E26

MADE OF: Opalflex®

WITH: Dimmer - Aluminum profiles

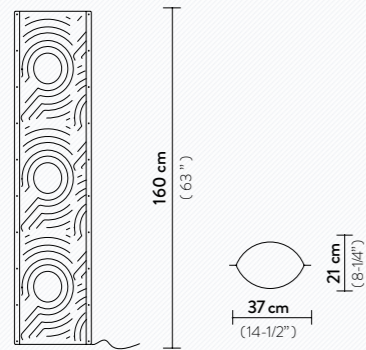

COLOURS:



WHITE

WOODY SUSPENSION

1 X 12W LED Filament Bulb E27/E26

Dimmable with dimmable bulbs

MADE OF: Polycarbonate / Wood

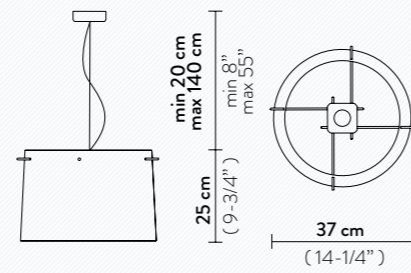

COLOURS:



WHITE



ORANGE



PURPLE



BLUE



SLAMP®

THE LEADING LIGHT

ALL SLAMP PRODUCTS ARE PRODUCED AND ASSEMBLED IN ITALY

WWW.SLAMP.IT

The company in this catalogue suggests the lightbulb wattage for an optimal balance of illumination and aesthetic output per product, as well as bulb size: E27/E26: Ø6 cm (2-1/4") E14/E12 Ø4,5cm (1-1/2"). Higher wattage can be used as long as the bulb is exclusively LED and matches the required size.

Il wattaggio delle lampadine sul seguente catalogo è suggerito dall'azienda per un ottimale balance fra resa luminosa ed estetica del prodotto oltre che alla dimensione del bulbo E27: Ø6 cm - E14: Ø4,5cm. Possono essere utilizzati wattaggi superiori purchè si utilizzino esclusivamente lampadine LED con una dimensione del bulbo adeguata.

Products are patented throughout the world and conform to the leading electrical safety standards. For any further info please ask your Slamp representative.

CE IP 20         CB REPORT AVAILABLE ON REQUEST



All Slamp lamps are RAEE Standards compliant
Tutte le lampade Slamp sono conformi alla Normativa RAEE

SLAMP S.p.A.
reserves the right to modify products without notice
in the event of commercial conditions rendering this necessary.
Slight differences of colour in some products in this catalogue
are due to the processes involved in printing.

SLAMP S.p.A.
si riserva il diritto di apportare modifiche ai prodotti senza
alcun preavviso, qualora le condizioni commerciali lo rendessero
necessario. Difformità di colore di alcuni prodotti sul presente
catalogo sono dovute a processi di stampa.

SPECIAL THANKS TO



KNOWING OR RECOGNIZING THE LANGUAGE OF LIGHT
MEANS BEING CO-CREATORS WITH THOUGHTS, IDEAS AND
EMOTIONS OF THE WORLD IN WHICH WE LIVE IN, AS WE DO
ON THE MATERIAL LEVEL WITH ACTIONS.

CONOSCERE, O RICONOSCERE IL LINGUAGGIO DELLA LUCE,
VUOL DIRE ESSERE CO-CREATORI ATTRAVERSO I NOSTRI
PENSIERI, IDEE ED EMOZIONI - COME LO SIAMO
SUL PIANO MATERICO CON LE AZIONI -
DEL MONDO IN CUI CI TROVIAMO.

LUCA MAZZA
Slamp Creative Director

HANDMADE IN ITALY
WWW.SLAMP.COM

THE
LANGUAGE
OF LIGHT

SLAMP: