



900559 MARMORATA

ceiling light; aluminium, steel, black, white / plastic, white
Deckenleuchte; Alu, Stahl, schwarz, weiss / Kunststoff, weiss
plafonnier; aluminium, acier, noir, blanc / plastique, blanc

L 445, B 445



900561 MARMORATA

ceiling light; aluminium, steel, black, white / plastic, white
Deckenleuchte; Alu, Stahl, schwarz, weiss / Kunststoff, weiss
plafonnier; aluminium, acier, noir, blanc / plastique, blanc

L 595, B 295



900558 MARMORATA

ceiling light; aluminium, steel, black, white / plastic, white
Deckenleuchte; Alu, Stahl, schwarz, weiss / Kunststoff, weiss
plafonnier; aluminium, acier, noir, blanc / plastique, blanc

H 70, Ø 450





98319



98317



98318

98319 BOCADELLA 1

ceiling light; steel, black
Deckenleuchte; Stahl, schwarz
plafonnier; acier, noir

H 360, Ø 920



E27



12x 60W



9 002759 983192

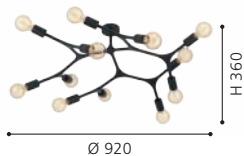

98317 BOCADELLA 1

ceiling light; steel, black
Deckenleuchte; Stahl, schwarz
plafonnier; acier, noir

H 215, Ø 345



E27



3x 60W



9 002759 983178

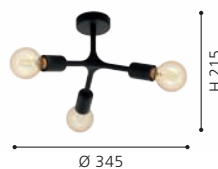

98318 BOCADELLA 1

ceiling light; steel, black
Deckenleuchte; Stahl, schwarz
plafonnier; acier, noir

H 365, Ø 640



E27



9x 60W



9 002759 983185

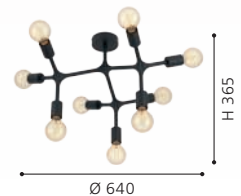



98507

98507 TREMEDAL

ceiling light; steel, black
Deckenleuchte; Stahl, schwarz
plafonnier; acier, noir

H 215, Ø 560



E27



1x 28W

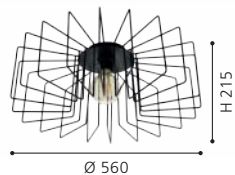



900367

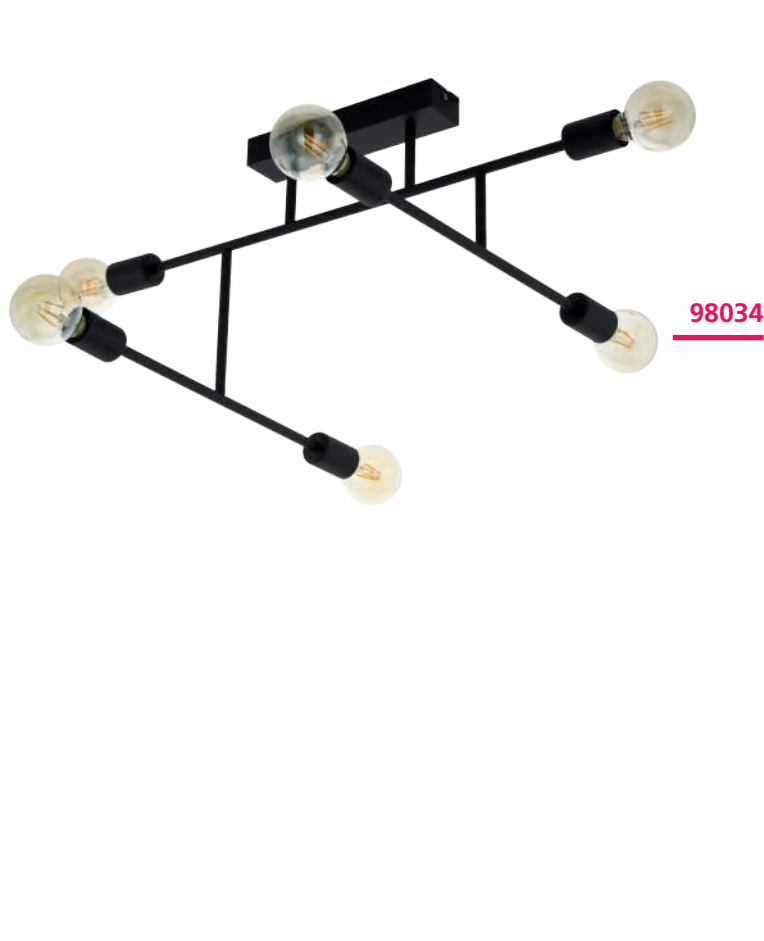

98034

900367 MESSINARO

ceiling light; steel, black, brushed brass
 Deckenleuchte; Stahl, schwarz, messing-gebürstet
 plafonnier; acier, noir, laiton brossé

L 720, B 280, H 115



E27



3x 40W

98034 BELSIANA

ceiling light; steel, black
 Deckenleuchte; Stahl, schwarz
 plafonnier; acier, noir

L 890, B 510, H 350



E27



6x 40W



9 008606 243525

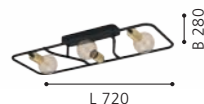

9 002759 980344

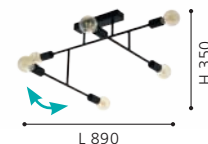



98035

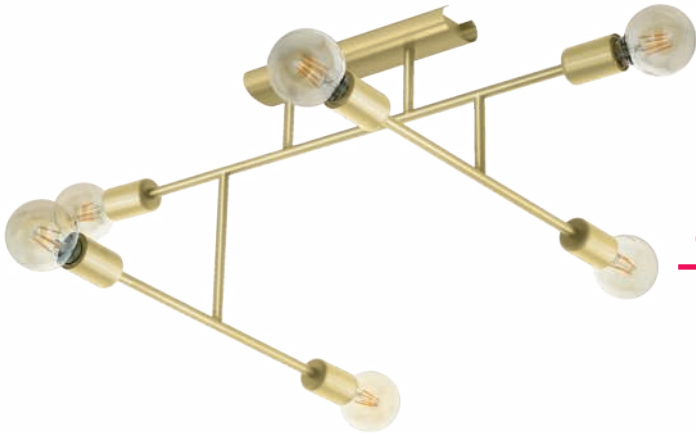

98881

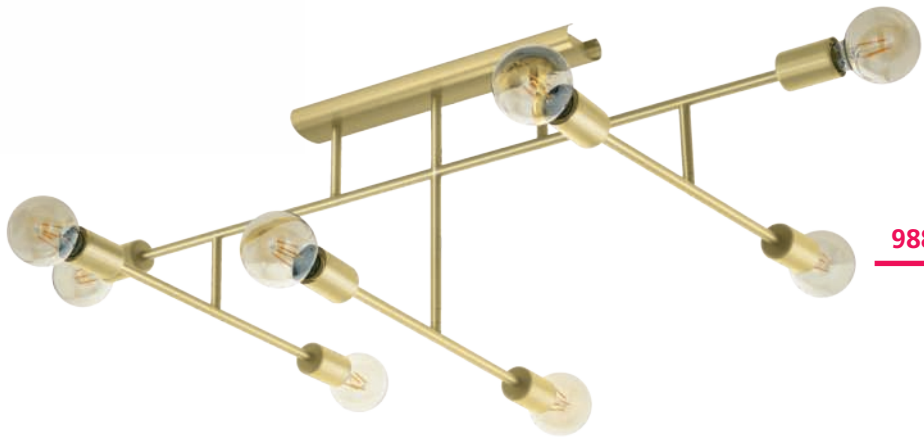

98882

98035 BELSIANA

ceiling light; steel, black
Deckenleuchte; Stahl, schwarz
plafonnier; acier, noir

L 1180, B 510, H 350



E27 8x 40W

98881 BELSIANA 1

ceiling light; steel, brushed brass
Deckenleuchte; Stahl, messing-gebürstet
plafonnier; acier, laiton brossé

L 1155, B 510, H 455



E27 6x 40W

98882 BELSIANA 1

ceiling light; steel, brushed brass
Deckenleuchte; Stahl, messing-gebürstet
plafonnier; acier, laiton brossé

L 1180, B 510, H 350



E27 8x 40W



9 002759 980351

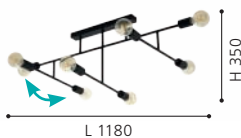

9 002759 988814

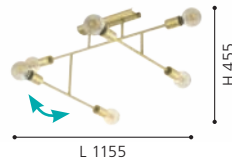

9 002759 988821

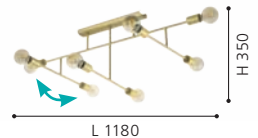



99664





900721



MOGANO 3



900792

99664 ENCINITOS

ceiling light; steel, black, gold
Deckenleuchte; Stahl, schwarz, gold
plafonnier; acier, noir, or

H 260, Ø 450



E27 1x 40W



9 002759 996642

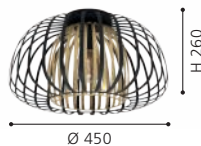

900721 MOGANO 3

ceiling light; steel, black
Deckenleuchte; Stahl, schwarz
plafonnier; acier, noir

H 180, Ø 430



E27 1x 40W



9 008606 254309

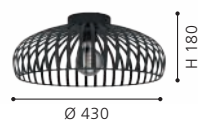

900792 MOGANO 3

ceiling light; steel, black
Deckenleuchte; Stahl, schwarz
plafonnier; acier, noir

H 180, Ø 280



E27 1x 40W



9 008606 254217





97731

LED



900302



97731 MONTEBALDO

ceiling light; steel, black, gold
Deckenleuchte; Stahl, schwarz, gold
plafonnier; acier, noir, or

L 380, B 380, H 170



GU10



4x 4,5W



4x
345lm

900302 BARRANCAS

ceiling light; steel, black, gold / brilliant glass, clear
Deckenleuchte; Stahl, schwarz, gold / Brillantglas, klar
plafonnier; acier, noir, or / verre brillant, transparent

L 380, B 380, H 180



E14



4x 40W



9 002759 977313



INCL.

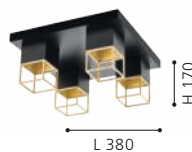

9 008606 242764

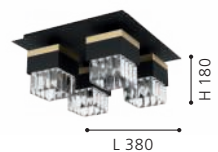



900524



97904



97895

900524 MORDAZO

ceiling light; steel, black / fabric, wood, anthracite-brown, white
 Deckenleuchte; Stahl, schwarz / Textil, Holz, anthrazit-braun, weiss
 plafonnier; acier, noir / tissu, bois, marron anthracite, blanc

L 510, B 510, H 175



E27 4x 28W

97904 STAITI

ceiling light; steel, black
 Deckenleuchte; Stahl, schwarz
 plafonnier; acier, noir

H 140, Ø 760



E27 7x 60W

97895 STAITI

ceiling light; steel, black / fabric, black, gold
 Deckenleuchte; Stahl, schwarz / Textil, schwarz, gold
 plafonnier; acier, noir / tissu, noir, or

H 235, Ø 840



E27 7x 40W



9 008606 244522

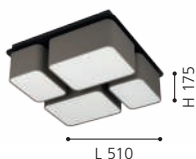

9 002759 979041

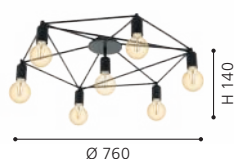

9 002759 978952





98333



98331



98332

98333 SILENTINA

ceiling light; steel, black
Deckenleuchte; Stahl, schwarz
plafonnier; acier, noir

L 540, B 180, H 205



E27



3x 40W

98331 SILENTINA

ceiling light; steel, black
Deckenleuchte; Stahl, schwarz
plafonnier; acier, noir

L 180, B 180, H 205



E27



1x 40W

98332 SILENTINA

ceiling light; steel, black
Deckenleuchte; Stahl, schwarz
plafonnier; acier, noir

L 360, B 180, H 205



E27



2x 40W



9 002759 983338

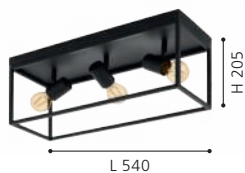

L 540



9 002759 983314

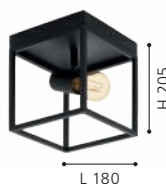

L 180



9 002759 983321

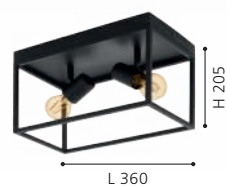

L 360



98334

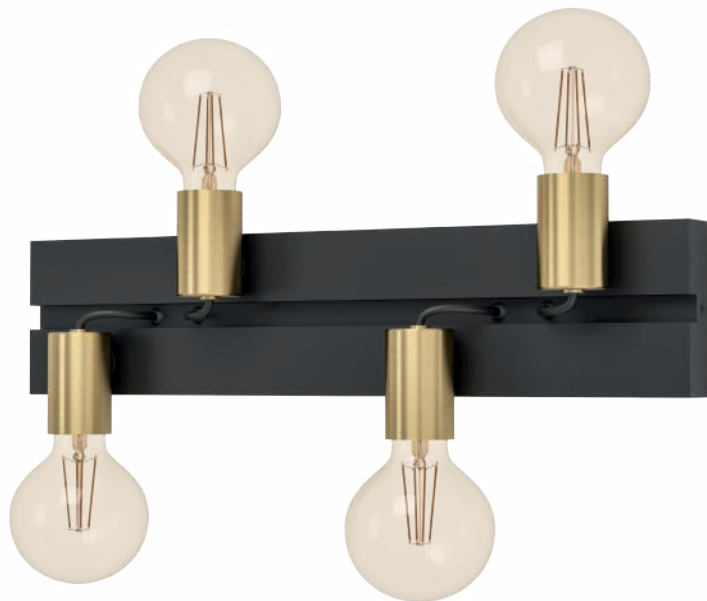

900509

98334 SILENTINA

ceiling light; steel, black
Deckenleuchte; Stahl, schwarz
plafonnier; acier, noir

L 360, B 360, H 205



9 002759 983345

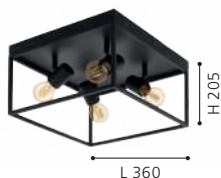

900509 MACCHIONE

wall light; steel, black, brass
Wandleuchte; Stahl, schwarz, messing
Applique; acier, noir, laiton

L 500, H 110, A 85



9 008606 244393

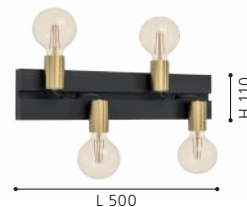

900509

Sockets are individually alignable for the customer with the help of a magnet. The luminaires work both as a wall luminaire, and as a ceiling luminaire.

Fassungen sind mithilfe eines Magnets für den Kunden individuell ausrichtbar. Die Leuchten funktionieren sowohl als Wandleuchte, als auch als Deckenleuchte.

Les douilles peuvent être orientées individuellement par le client à l'aide d'un aimant. Les luminaires fonctionnent aussi bien comme appliques murales que comme plafonniers.





900357 PIEDRITAS

ceiling light; steel, black
Deckenleuchte; Stahl, schwarz
plafonnier; acier, noir

L 730, B 180, H 205



E27



3x 40W

900356 PIEDRITAS

ceiling light; steel, black
Deckenleuchte; Stahl, schwarz
plafonnier; acier, noir

L 515, B 180, H 205



E27



2x 40W

900355 PIEDRITAS

ceiling light; steel, black
Deckenleuchte; Stahl, schwarz
plafonnier; acier, noir

L 180, B 180, H 205



E27



1x 40W



9 008606 235728

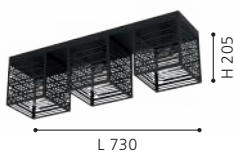

9 008606 235711



9 008606 235704

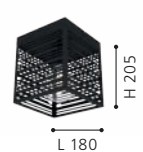



900355





94547



94548



900359

94547 MOGANO

ceiling light; steel, black, copper
Deckenleuchte; Stahl, schwarz, kupfer
plafonnier; acier, noir, cuivre

H 170, Ø 400



94548 MOGANO

ceiling light; steel, white, silver
Deckenleuchte; Stahl, weiss, silber
plafonnier; acier, blanc, argent

H 170, Ø 400



900359 MOGANO

ceiling light; steel, mocha-coloured
Deckenleuchte; Stahl, Mokkafarben
plafonnier; acier, café

H 175, Ø 400



9 002759 945473

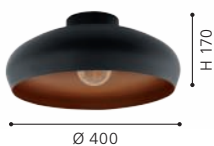

9 002759 945480



9 008606 235315

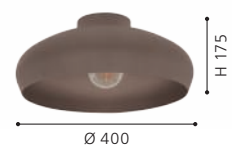



43637



43637 MOGANO

ceiling light; steel, black
Deckenleuchte; Stahl, schwarz
plafonnier; acier, noir

H 170, Ø 400



E27



1x 60W



9 002759 436377

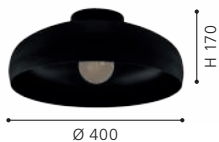



900553



900554



900555

900553 MOGANO 2

ceiling light; steel, black
Deckenleuchte; Stahl, schwarz
plafonnier; acier, noir

H 175, Ø 280



E27



1x 40W

900554 MOGANO 2

ceiling light; steel, black, gold
Deckenleuchte; Stahl, schwarz, gold
plafonnier; acier, noir, or

H 175, Ø 280



E27



1x 40W

900555 MOGANO 2

ceiling light; steel, black, copper
Deckenleuchte; Stahl, schwarz, kupfer
plafonnier; acier, noir, cuivre

H 175, Ø 280



E27



1x 40W



9 008606 244584



9 008606 244591



9 008606 244607

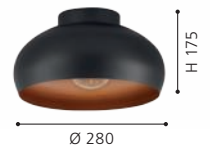



900848



900736



900848 CENCIARA

ceiling light; steel, black / steel, brushed brass, gold
 Deckenleuchte; Stahl, schwarz / Stahl, messing-gebürstet, gold
 plafonnier; acier, noir / acier, laiton brossé, or

H 180, Ø 400



E27 1x 40W

900736 MOHARRAS

ceiling light; wood, brown / steel, sandy
 Deckenleuchte; Holz, braun / Stahl, sandfarben
 plafonnier; bois, marron / acier, couleur sable

H 160, Ø 400



E27 1x 40W



9 008606 274383

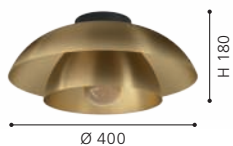

9 008606 263325



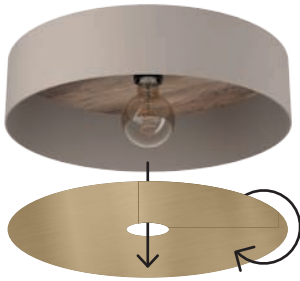

DUAIA

The look of these luminaires can be changed very easily thanks to the reversible plate. Front: wood look / back: brushed brass

Die Optik dieser Leuchten lässt sich durch die umkehrbare Platte ganz einfach verändern. Vorderseite: holzoptik / Rückseite: messing gebürstet

L'aspect de ces luminaires peut être facilement modifié grâce à la plaque réversible. face avant : aspect bois / face arrière : laiton brossé



900837



900838



900837 DUAIA

ceiling light; steel, umbra grey / wood, steel, brown, brushed brass

Deckenleuchte; Stahl, Umbragrau / Holz, Stahl, braun, messing-gebürstet

plafonnier; acier, Gris ombre / bois, acier, marron, laiton brossé

H 160, Ø 420



900838 DUAIA

ceiling light; steel, taupe structure / wood, steel, brown, brushed brass

Deckenleuchte; Stahl, taupe-struktur / Holz, Stahl, braun, messing-gebürstet

plafonnier; acier, taupe structuré / bois, acier, marron, laiton brossé

H 160, Ø 420



9 008606 269129

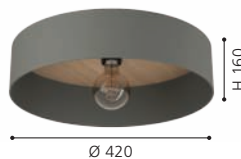

9 008606 269136





900435



900443



900435 VALCASOTTO 1

ceiling light; steel, wood, black, brown
 Deckenleuchte; Stahl, Holz, schwarz, braun
 plafonnier; acier, bois, noir, marron

L 370, B 370, H 100



GU10



4x 4,5W



warm
WHITE

4x

345lm

900443 TARRAFO

ceiling light; steel, wood, black, brown
 Deckenleuchte; Stahl, Holz, schwarz, braun
 plafonnier; acier, bois, noir, marron

L 640, B 150, H 155



E27



3x 40W



9 008606 240586

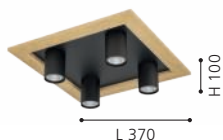

9 008606 243945

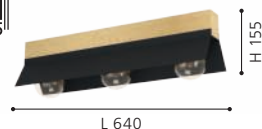



99667



900188

DESIGN
HIGHLIGHT
DETAIL



99667 BASURTU

ceiling light; steel, black
Deckenleuchte; Stahl, schwarz
plafonnier; acier, noir

H 270, Ø 1050

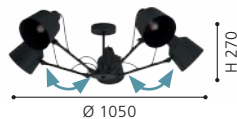

900188 LORETO

ceiling light; steel, black, white
Deckenleuchte; Stahl, schwarz, weiss
plafonnier; acier, noir, blanc

H 355, Ø 1145

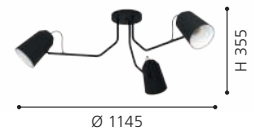



900157



900614



900865

900157 LORETO

wall light; steel, black, white
Wandleuchte; Stahl, schwarz, weiss
Applique; acier, noir, blanc

L 670, B 140, H 365



E27 1x 40W



9 008606 235766



L 670

H 365

900614 LORETO 1

wall light; steel, black, white
Wandleuchte; Stahl, schwarz, weiss
Applique; acier, noir, blanc

L 140, H 350, A 1030



E27 1x 28W



9 008606 245116

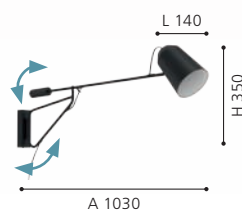

A 1030

L 140

H 350

900865 FORCADET

wall light; steel, black, grey
Wandleuchte; Stahl, schwarz, grau
Applique; acier, noir, gris

L 180, H 405, A 905



E27 1x 40W



9 008606 273942

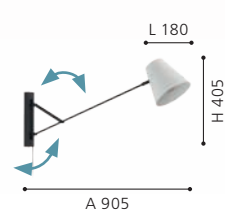

A 905

L 180

H 405



900361



98514



98514

900361 MARIEL

ceiling light; steel, wood, light grey, brown
 Deckenleuchte; Stahl, Holz, hellgrau, braun
 plafonnier; acier, bois, gris clair, marron

L 910, B 190, H 255



98514 MAROJALES

ceiling light; steel, black / glass vaporized, black-transparent
 Deckenleuchte; Stahl, schwarz / Glas bedampft, schwarz-transparent
 plafonnier; acier, noir / verre vaporisé, noir transparent

L 555, B 180, H 280

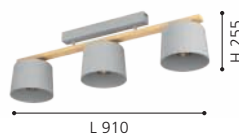



900825



900826



900185



900825 FILAGO

ceiling light; wood, steel, brown / glass, black-grey-transparent
Deckenleuchte; Holz, Stahl, braun / Glas, schwarz-grau-transparent
plafonnier; bois, acier, marron / verre, noir gris transparent

H 200, Ø 145



E27 1x 40W

900826 FILAGO

wall light; wood, steel, brown, black / glass, black-grey-transparent
Wandleuchte; Holz, Stahl, braun, schwarz / Glas, schwarz-grau-transparent
Applique; bois, acier, marron, noir / verre, noir gris transparent

L 145, H 200, A 200



E27 1x 40W

900185 FILAGO

ceiling light; steel, wood, black, brown / glass, black-grey-transparent
Deckenleuchte; Stahl, Holz, schwarz, braun / Glas, schwarz-grau-transparent
plafonnier; acier, bois, noir, marron / verre, noir gris transparent

L 880, B 145, H 250



E27 4x 40W



9 008606 263332



9 008606 263349



9 008606 235322





92727



30931

LED

92727 CONDRA 1

ceiling light; steel, chrome / satin glass, white
Deckenleuchte; Stahl, chrom / Glas satiniert, weiss
plafonnier; acier, chrome / verre satiné, blanc

L 470, B 470, H 300



30931 CABO

ceiling light; stainless steel, chrome / satin glass, white, clear
Deckenleuchte; Edelstahl, chrom / Glas satiniert, weiss, klar
plafonnier; acier inoxydable, chrome / verre satiné, blanc, transparent

L 290, B 290, H 70

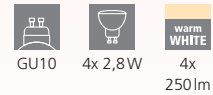

9 002759 927271

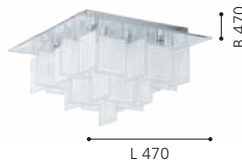

9 002759 309312





95639

LED



95284



EGLO
RECOMMENDS
110003

CLEMENTE



95285

95639 ACOLLA

wall/ceiling light; steel, chrome / glass with brilliant glass, white, clear

Wand- / Deckenleuchte; Stahl, chrom / Glas mit Brillantglas, weiss, klar

Applique/Plafonnier; acier, chrome / verre avec verre brillant, blanc, transparent

H 85, Ø 290

LED

warm
WHITE



3x 3,6W 1110lm

95284 CLEMENTE

ceiling light; steel, chrome / brilliant glass, clear

Deckenleuchte; Stahl, chrom / Brillantglas, klar

plafonnier; acier, chrome / verre brillant, transparent

H 200, Ø 350



E27



2x 60W

95285 CLEMENTE

ceiling light; steel, chrome / brilliant glass, clear

Deckenleuchte; Stahl, chrom / Brillantglas, klar

plafonnier; acier, chrome / verre brillant, transparent

H 205, Ø 450



E27



3x 60W



9 002759 956394



9 002759 952846

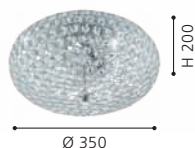

9 002759 952853

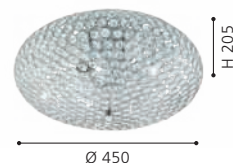



99324

LED



99325

LED



99328

LED

99324 FRADELO 1

wall/ceiling light; steel, black / plastic, brilliant glass, black, clear
Wand- / Deckenleuchte; Stahl, schwarz / Kunststoff, Brillantglas, schwarz, klar
Applique/Plafonnier; acier, noir / plastique, verre brillant, noir, transparent

L 140, B 140, H 60



1x 3,2W 400lm

99325 FRADELO 1

wall/ceiling light; steel, black / plastic, brilliant glass, black, clear
Wand- / Deckenleuchte; Stahl, schwarz / Kunststoff, Brillantglas, schwarz, klar
Applique/Plafonnier; acier, noir / plastique, verre brillant, noir, transparent

L 460, B 140, H 60



3x 3,5W 1200lm

99328 FRADELO 1

ceiling light; steel, black / plastic, brilliant glass, black, clear
Deckenleuchte; Stahl, schwarz / Kunststoff, Brillantglas, schwarz, klar
plafonnier; acier, noir / plastique, verre brillant, noir, transparent

L 520, B 520, H 95



46,5W 5500lm



9 002759 993245

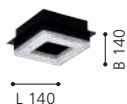

9 002759 993252

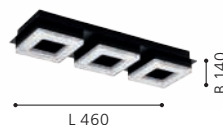

9 002759 993283





99327

LED

99327 FRADELO 1

ceiling light; steel, black / plastic, brilliant glass, black, clear
 Deckenleuchte; Stahl, schwarz / Kunststoff, Brillantglas, schwarz, klar
 plafonnier; acier, noir / plastique, verre brillant, noir, transparent

L 260, B 260, H 85

 LED	 warm WHITE	 LED	 warm WHITE	
4x 2W	920lm	1x 3,5W	400lm	

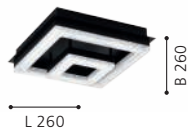



95655

LED

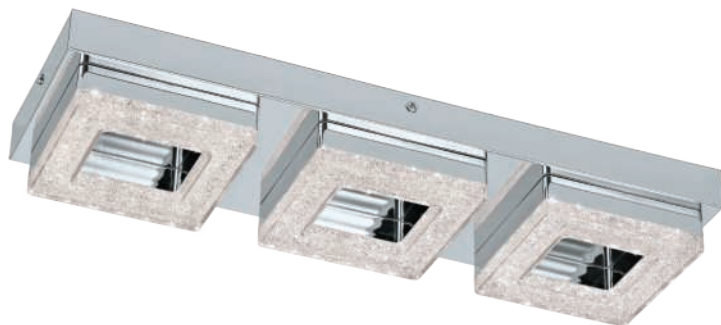

95656

LED

95655 FRADELO

wall/ceiling light; steel, chrome / plastic, brilliant glass, chrome, clear

Wand- / Deckenleuchte; Stahl, chrom / Kunststoff, Brillantglas, chrom, klar

Applique/Plafonnier; acier, chrome / plastique, verre brillant, chrome, transparent

L 140, B 140, H 60

LED

warm WHITE



1x 3,2W

400lm

95656 FRADELO

wall/ceiling light; steel, chrome / plastic, brilliant glass, chrome, clear

Wand- / Deckenleuchte; Stahl, chrom / Kunststoff, Brillantglas, chrom, klar

Applique/Plafonnier; acier, chrome / plastique, verre brillant, chrome, transparent

L 460, B 140, H 60

LED

warm WHITE



3x 3,5W

1200lm



9 002759 956554

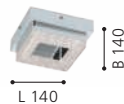

9 002759 956561

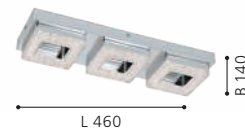

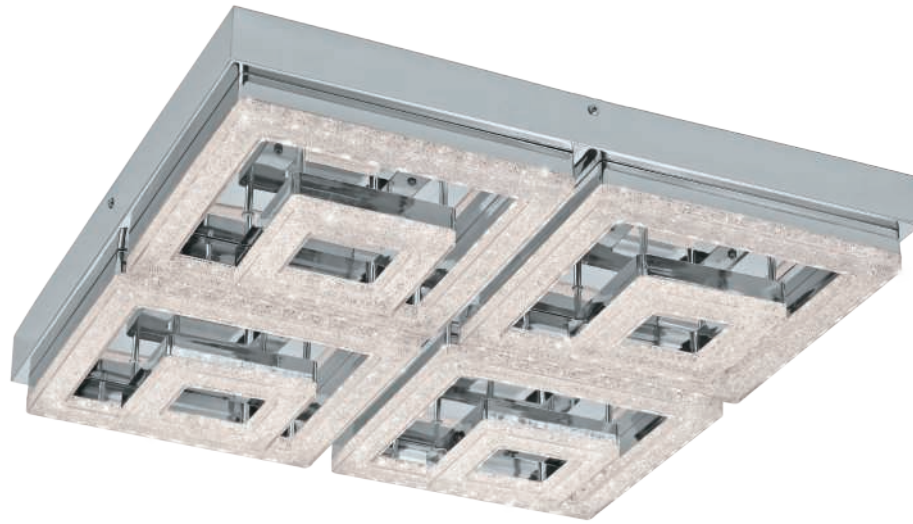

95661



95657



95659



95661 FRADELO

ceiling light; steel, chrome / plastic, brilliant glass, chrome, clear
 Deckenleuchte; Stahl, chrom / Kunststoff, Brillantglas, chrom, klar
 plafonnier; acier, chrome / plastique, verre brillant, chrome, transparent

L 520, B 520, H 95



46,5W 5500lm



9 002759 956615

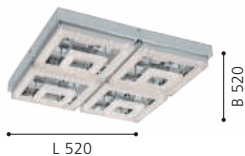

95657 FRADELO

wall/ceiling light; steel, chrome / plastic, brilliant glass, chrome, clear
 Wand- / Deckenleuchte; Stahl, chrom / Kunststoff, Brillantglas, chrom, klar
 Applique/Plafonnier; acier, chrome / plastique, verre brillant, chrome, transparent

L 280, B 280, H 60



4x 3,5W 1600lm



9 002759 956578

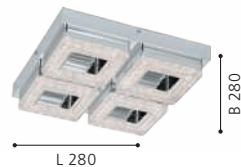

95659 FRADELO

ceiling light; steel, chrome / plastic, brilliant glass, chrome, clear
 Deckenleuchte; Stahl, chrom / Kunststoff, Brillantglas, chrom, klar
 plafonnier; acier, chrome / plastique, verre brillant, chrome, transparent

L 260, B 260, H 85



4x 2W 920lm 1x 3,5W 400lm



9 002759 956592

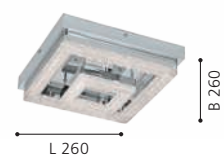



97487

LED



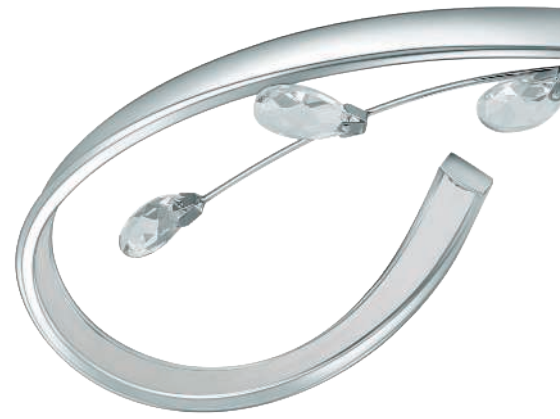

95689, 97487

These luminaires come with high quality brilliant glass.

Diese Leuchten sind mit hochwertigem Brillantglas ausgestattet.

Ces lumières sont fabriquées avec une haute qualité Equipé de verre brillant.



95689



97487 VALLEMARE

wall/ceiling light; aluminium, steel, chrome / plastic, brilliant glass, white, clear

Wand- / Deckenleuchte; Alu, Stahl, chrom / Kunststoff, Brillantglas, weiss, klar

Applique/Plafonnier; aluminium, acier, chrome / plastique, verre brillant, blanc, transparent

H 125, Ø 650



5x 6,6W 4500lm

95689 SORRENTA 1

wall/ceiling light; steel, white / glass with brilliant glass, white, clear

Wand- / Deckenleuchte; Stahl, weiss / Glas mit Brillantglas, weiss, klar

Applique/Plafonnier; acier, blanc / verre avec verre brillant, blanc, transparent

H 95, Ø 315



3x 3,8W 1170lm

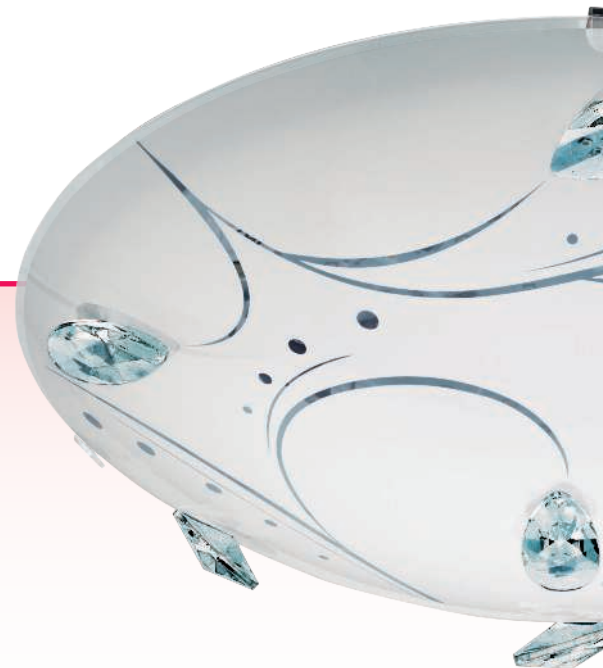

9 002759 974879

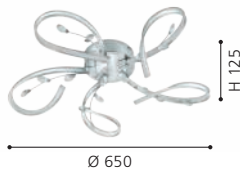

9 002759 956899

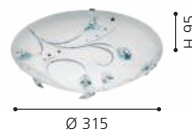



98527

LED

incl./inkl./inclus



 TUNABLE WHITE	 STEP DIMMING	 NIGHT LIGHT FUNCTION	98527 <hr/> 98685
1. warmwhite (2700 K/100 %) 2. neutralwhite 3850 K (2700 K/50 % + 5000 K/50 %) 3. coldwhite (5000 K/100 %)			



98685

LED

incl./inkl./inclus



98527 CANICOSA 2

wall/ceiling light; plastic, steel, black, gold / plastic, granules, transparent

Wand- / Deckenleuchte; Kunststoff, Stahl, schwarz, gold / Kunststoff mit Granille, transparent

Applique/Plafonnier; plastique, acier, noir, or / plastique granité, transparent

H 90, Ø 495



24,5W 3200lm

98685 CANICOSA 2

wall/ceiling light; plastic, steel, black, gold / plastic, granules, transparent

Wand- / Deckenleuchte; Kunststoff, Stahl, schwarz, gold / Kunststoff mit Granille, transparent

Applique/Plafonnier; plastique, acier, noir, or / plastique granité, transparent

H 145, Ø 765



4x 4,5W 2120lm 3x 4,5W 1590lm 4x 2,2W



1040lm



9 002759 985271



9 002759 986858

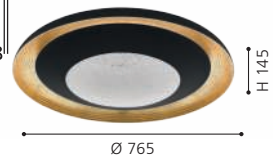



98487

LED



98023

LED



98488

LED

98023 MONTENOVO

wall/ceiling light; steel, white / glass, white, gold
Wand- / Deckenleuchte; Stahl, weiss / Glas, weiss, gold
Applique/Plafonnier; acier, blanc / verre, blanc, or

H 100, Ø 395



3x 7,3W 2220lm



9 002759 980238



98487 POZONDON

ceiling light; steel, gold-coloured / plastic, white
Deckenleuchte; Stahl, goldfarben / Kunststoff, weiss
plafonnier; acier, or / plastique, blanc

H 100, Ø 380



18W 2300lm



9 002759 984878

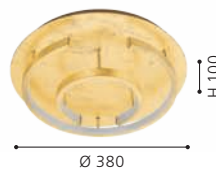

98488 POZONDON

ceiling light; steel, gold-coloured / plastic, white
Deckenleuchte; Stahl, goldfarben / Kunststoff, weiss
plafonnier; acier, or / plastique, blanc

H 120, Ø 520



22,5W 3100lm



9 002759 984885

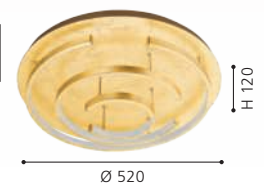



97526



incl./inkl./inclus



97527



incl./inkl./inclus



97528



incl./inkl./inclus



				<u>97526</u>	<u>97541</u>
TUNABLE WHITE	DIMMABLE	TIMER FUNCTION	NIGHT LIGHT FUNCTION	<u>97527</u>	<u>97542</u>
3000 - 5000 K	10 - 100 %	off after 30sec.		<u>97528</u>	<u>97543</u>

97526 GIRON

ceiling light; steel, white / plastic, white
Deckenleuchte; Stahl, weiss / Kunststoff, weiss
plafonnier; acier, blanc / plastique, blanc

H 75, Ø 570



36W



4300lm



Remote

97527 GIRON

ceiling light; steel, white / plastic, white
Deckenleuchte; Stahl, weiss / Kunststoff, weiss
plafonnier; acier, blanc / plastique, blanc

H 85, Ø 760



54,5W



6500lm



Remote

97528 GIRON

ceiling light; steel, white / plastic, white
Deckenleuchte; Stahl, weiss / Kunststoff, weiss
plafonnier; acier, blanc / plastique, blanc

H 120, Ø 1000



73W



9800lm



Remote



9 002759 975265

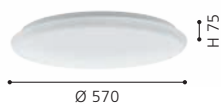

9 002759 975272



9 002759 975289

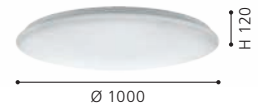



97541



incl./inkl./inclus



97542



incl./inkl./inclus



97543



incl./inkl./inclus



97541 GIRON-S

ceiling light; steel, white / plastic with crystal effect, white
Deckenleuchte; Stahl, weiss / Kunststoff m.Kristalleffekt, weiss
plafonnier; acier, blanc / plastique avec effet cristal, blanc

H 75, Ø 570



36W



4300lm



Remote



9 002759 975418

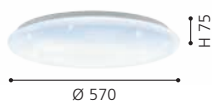

Ø 570

97542 GIRON-S

ceiling light; steel, white / plastic with crystal effect, white
Deckenleuchte; Stahl, weiss / Kunststoff m.Kristalleffekt, weiss
plafonnier; acier, blanc / plastique avec effet cristal, blanc

H 85, Ø 760



54,5W



6500lm



Remote



9 002759 975425

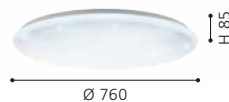

Ø 760

97543 GIRON-S

ceiling light; steel, white / plastic with crystal effect, white
Deckenleuchte; Stahl, weiss / Kunststoff m.Kristalleffekt, weiss
plafonnier; acier, blanc / plastique avec effet cristal, blanc

H 120, Ø 1000



73W



9800lm



Remote



9 002759 975432

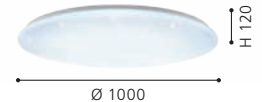

Ø 1000



97871



97872



97873



97871 FRANIA

wall/ceiling light; steel, white / plastic, white
Wand- / Deckenleuchte; Stahl, weiss / Kunststoff, weiss
Applique/Plafonnier; acier, blanc / plastique, blanc

H 70, Ø 280



10W



1100lm



97872 FRANIA

wall/ceiling light; steel, white / plastic, white
Wand- / Deckenleuchte; Stahl, weiss / Kunststoff, weiss
Applique/Plafonnier; acier, blanc / plastique, blanc

H 70, Ø 330



14,6W



1600lm



97873 FRANIA

wall/ceiling light; steel, white / plastic, white
Wand- / Deckenleuchte; Stahl, weiss / Kunststoff, weiss
Applique/Plafonnier; acier, blanc / plastique, blanc

H 70, Ø 430



6x 5,5W



3600lm



9 002759 978716

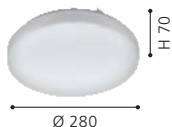

9 002759 978723



9 002759 978730

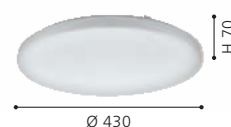



98446



98446 FRANIA

wall/ceiling light; steel, white / plastic, white

Wand- / Deckenleuchte; Stahl, weiss / Kunststoff, weiss

Applique/Plafonnier; acier, blanc / plastique, blanc

H 70, Ø 550



50W



5900lm



9 002759 984465

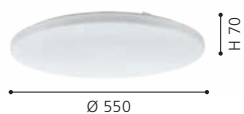



97877



97878



97879



97877 FRANIA-S

wall/ceiling light; steel, white / plastic with crystal effect, white
Wand- / Deckenleuchte; Stahl, weiss / Kunststoff m.Kristalleffekt, weiss
Applique/Plafonnier; acier, blanc / plastique avec effet cristal, blanc

H 70, Ø 280



10W



1100lm



97878 FRANIA-S

wall/ceiling light; steel, white / plastic with crystal effect, white
Wand- / Deckenleuchte; Stahl, weiss / Kunststoff m.Kristalleffekt, weiss
Applique/Plafonnier; acier, blanc / plastique avec effet cristal, blanc

H 70, Ø 330



14,6W



1600lm



97879 FRANIA-S

wall/ceiling light; steel, white / plastic with crystal effect, white
Wand- / Deckenleuchte; Stahl, weiss / Kunststoff m.Kristalleffekt, weiss
Applique/Plafonnier; acier, blanc / plastique avec effet cristal, blanc

H 70, Ø 430



6x 5,5W



3600lm



9 002759 978778

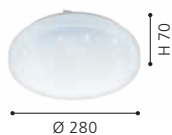

9 002759 978785



9 002759 978792





98448

LED



98448 FRANIA-S

wall/ceiling light; steel, white / plastic with crystal effect, white

Wand- / Deckenleuchte; Stahl, weiss / Kunststoff m. Kristalleffekt, weiss

Applique/Plafonnier; acier, blanc / plastique avec effet cristal, blanc

H 70, Ø 550



9 002759 984489

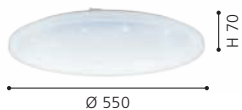



97874



97875



97876



97874 FRANIA

wall/ceiling light; steel, white / plastic, white
Wand- / Deckenleuchte; Stahl, weiss / Kunststoff, weiss
Applique/Plafonnier; acier, blanc / plastique, blanc

L 280, B 280, H 70



10W 1100lm

97875 FRANIA

wall/ceiling light; steel, white / plastic, white
Wand- / Deckenleuchte; Stahl, weiss / Kunststoff, weiss
Applique/Plafonnier; acier, blanc / plastique, blanc

L 330, B 330, H 70



14,6W 1600lm

97876 FRANIA

wall/ceiling light; steel, white / plastic, white
Wand- / Deckenleuchte; Stahl, weiss / Kunststoff, weiss
Applique/Plafonnier; acier, blanc / plastique, blanc

L 430, B 430, H 70



6x 5,5W 3600lm



9 002759 978747

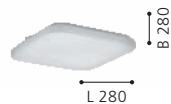

9 002759 978754

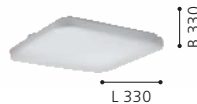

9 002759 978761

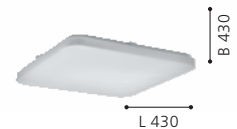



98447

LED



98447 FRANIA

wall/ceiling light; steel, white / plastic, white

Wand- / Deckenleuchte; Stahl, weiss / Kunststoff, weiss

Applique/Plafonnier; acier, blanc / plastique, blanc

L 530, B 530, H 70

LED

50W

warm
WHITE

5900lm



9 002759 984472





98449

LED



97882

LED



97881

LED



98449 FRANIA-S

wall/ceiling light; steel, white / plastic with crystal effect, white
Wand- / Deckenleuchte; Stahl, weiss / Kunststoff m.Kristalleffekt, weiss

Applique/Plafonnier; acier, blanc / plastique avec effet cristal, blanc

L 530, B 530, H 70

LED

warm
WHITE



50W

5900lm

97883 FRANIA-S

wall/ceiling light; steel, white / plastic with crystal effect, white
Wand- / Deckenleuchte; Stahl, weiss / Kunststoff m.Kristalleffekt, weiss

Applique/Plafonnier; acier, blanc / plastique avec effet cristal, blanc

L 430, B 430, H 70

LED

warm
WHITE



6x 5,5W

3600lm

97882 FRANIA-S

wall/ceiling light; steel, white / plastic with crystal effect, white
Wand- / Deckenleuchte; Stahl, weiss / Kunststoff m.Kristalleffekt, weiss

Applique/Plafonnier; acier, blanc / plastique avec effet cristal, blanc

L 330, B 330, H 70

LED

warm
WHITE



14,6W

1600lm



9 002759 984496

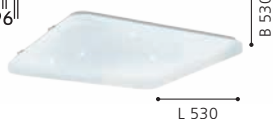

9 002759 978839

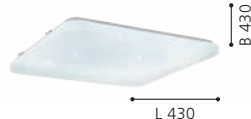

9 002759 978822

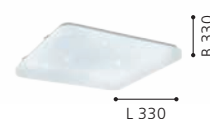



97883

LED



97578

LED

incl./inkl./inclus



97577

LED

incl./inkl./inclus



TUNABLE WHITE
2700 - 6500 K

STEP DIMMING
10/25/50/100 %

97577

97578

97881 FRANIA-S

wall/ceiling light; steel, white / plastic with crystal effect, white
Wand- / Deckenleuchte; Stahl, weiss / Kunststoff m.Kristalleffekt, weiss
Applique/Plafonnier; acier, blanc / plastique avec effet cristal, blanc

L 280, B 280, H 70

LED warm WHITE

10W 1100lm



9 002759 978815

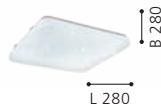

97578 SILERAS

wall/ceiling light; steel, white / plastic with crystal effect, white
Wand- / Deckenleuchte; Stahl, weiss / Kunststoff m.Kristalleffekt, weiss
Applique/Plafonnier; acier, blanc / plastique avec effet cristal, blanc

H 85, Ø 600

LED tunable WHITE Remote

31W 4600lm



9 002759 975784



97577 SILERAS

wall/ceiling light; steel, white / plastic with crystal effect, white
Wand- / Deckenleuchte; Stahl, weiss / Kunststoff m.Kristalleffekt, weiss
Applique/Plafonnier; acier, blanc / plastique avec effet cristal, blanc

H 85, Ø 450

LED tunable WHITE Remote

20,5W 2800lm



9 002759 975777





98323

LED

incl./inkl./inclus

98324

LED



incl./inkl./inclus



97737

LED

incl./inkl./inclus

 TUNABLE WHITE	 DIMMABLE	 TIMER FUNCTION	 NIGHT LIGHT FUNCTION	98323
	10 - 100 %	off after 30sec.		98324
				97737

98323 LANCIANO 1

wall/ceiling light; steel, white, transparent / plastic with crystal effect, white, chrome

Wand- / Deckenleuchte; Stahl, weiss, transparent / Kunststoff m. Kristalleffekt, weiss, chrom

Applique/Plafonnier; acier, blanc, transparent / plastique avec effet cristal, blanc, chrome

H 75, Ø 400



18,8W



2300lm



Remote

98324 LANCIANO 1

wall/ceiling light; steel, white, transparent / plastic with crystal effect, white, chrome

Wand- / Deckenleuchte; Stahl, weiss, transparent / Kunststoff m. Kristalleffekt, weiss, chrom

Applique/Plafonnier; acier, blanc, transparent / plastique avec effet cristal, blanc, chrome

H 80, Ø 560



33W



4000lm



Remote

97737 LANCIANO

ceiling light; steel, plastic, white, transparent / plastic with crystal effect, white, silver

Deckenleuchte; Stahl, Kunststoff, weiss, transparent / Kunststoff m. Kristalleffekt, weiss, silber

plafonnier; acier, plastique, blanc, transparent / plastique avec effet cristal, blanc, argent

H 100, Ø 660



36W



4300lm



Remote



9 002759 983239



9 002759 983246



9 002759 977375





900598



incl./inkl./inclus



900599



incl./inkl./inclus



900598 LANCIANO 1

ceiling light; steel, wood, white, brown / plastic with crystal effect, white

Deckenleuchte; Stahl, Holz, weiss, braun / Kunststoff m. Kristalleffekt, weiss

plafonnier; acier, bois, blanc, marron / plastique avec effet cristal, blanc

H 70, Ø 380



24W



2600lm



900599 LANCIANO 1

ceiling light; steel, wood, white, brown / plastic with crystal effect, white

Deckenleuchte; Stahl, Holz, weiss, braun / Kunststoff m. Kristalleffekt, weiss

plafonnier; acier, bois, blanc, marron / plastique avec effet cristal, blanc

H 80, Ø 480



35W



4000lm



9 008606 244973



9 008606 244980

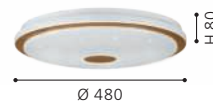



900608

LED



900607

LED

900608 FERENTINO

ceiling light; steel, white / plastic, white
 Deckenleuchte; Stahl, weiss / Kunststoff, weiss
 plafonnier; acier, blanc / plastique, blanc

H 60, Ø 380



19,5W 2300lm

900607 FERENTINO

ceiling light; steel, white / plastic, white
 Deckenleuchte; Stahl, weiss / Kunststoff, weiss
 plafonnier; acier, blanc / plastique, blanc

H 60, Ø 280



10W 1100lm



9 008606 245062

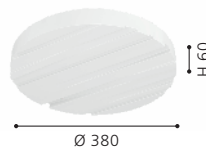

9 008606 245055

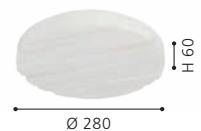



900611



900609



900609 FERENTINO

ceiling light; steel, white / plastic, white
Deckenleuchte; Stahl, weiss / Kunststoff, weiss
plafonnier; acier, blanc / plastique, blanc

L 280, B 280, H 60



10W 1100lm

900611 FERENTINO

ceiling light; steel, white / plastic, white
Deckenleuchte; Stahl, weiss / Kunststoff, weiss
plafonnier; acier, blanc / plastique, blanc

L 330, B 330, H 60



14,6W 1600lm



9 008606 245079

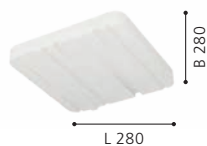

9 008606 245086





900606



900605



900605 BATTISTONA

ceiling light; steel, white / plastic, white
Deckenleuchte; Stahl, weiss / Kunststoff, weiss
plafonnier; acier, blanc / plastique, blanc

H 85, Ø 380



4x 2,9W 1280lm 4x 1,45W 640lm



9 008606 245031



900606 BATTISTONA

ceiling light; steel, white / plastic, white
Deckenleuchte; Stahl, weiss / Kunststoff, weiss
plafonnier; acier, blanc / plastique, blanc

H 100, Ø 480



20,8W 2500lm Remote



9 008606 245048

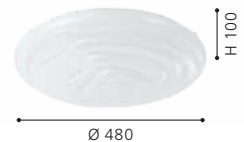



99344



99343



99343 BENARIBA

wall/ceiling light; steel, white / plastic, white
Wand- / Deckenleuchte; Stahl, weiss / Kunststoff, weiss
Applique/Plafonnier; acier, blanc / plastique, blanc

H 65, Ø 330



14,6W 1600lm

99344 BENARIBA

wall/ceiling light; steel, white / plastic, white
Wand- / Deckenleuchte; Stahl, weiss / Kunststoff, weiss
Applique/Plafonnier; acier, blanc / plastique, blanc

H 70, Ø 440



22W 2500lm



9 002759 993436



9 002759 993443





96032



96033



96034



96032 COMPETA 1

wall/ceiling light; steel, white / plastic, white, satin nickel
Wand- / Deckenleuchte; Stahl, weiss / Kunststoff, weiss, nickel-
matt
Applique/Plafonnier; acier, blanc / plastique, blanc, nickel mat

H 55, Ø 245



15,6W 1900lm

96033 COMPETA 1

wall/ceiling light; steel, white / plastic, white, satin nickel
Wand- / Deckenleuchte; Stahl, weiss / Kunststoff, weiss, nickel-
matt
Applique/Plafonnier; acier, blanc / plastique, blanc, nickel mat

H 55, Ø 325



18W 2200lm

96034 COMPETA 1

wall/ceiling light; steel, white / plastic, white, satin nickel
Wand- / Deckenleuchte; Stahl, weiss / Kunststoff, weiss, nickel-
matt
Applique/Plafonnier; acier, blanc / plastique, blanc, nickel mat

H 55, Ø 430



20W 2400lm



9 002759 960322



9 002759 960339



9 002759 960346





95679

LED



95682

LED



95684

LED



95679 COMPETA 1

wall/ceiling light; steel, white / plastic, white, silver, clear
Wand- / Deckenleuchte; Stahl, weiss / Kunststoff, weiss, silber, klar
Applique/Plafonnier; acier, blanc / plastique, blanc, argent, transparent

L 340, B 340, H 80



21W 2400lm

95682 PALERMO 2

wall/ceiling light; steel, white / plastic, white, chrome
Wand- / Deckenleuchte; Stahl, weiss / Kunststoff, weiss, chrom
Applique/Plafonnier; acier, blanc / plastique, blanc, chrome

H 70, Ø 280



15,6W 1900lm

95684 PALERMO 2

wall/ceiling light; steel, white / plastic, white, chrome
Wand- / Deckenleuchte; Stahl, weiss / Kunststoff, weiss, chrom
Applique/Plafonnier; acier, blanc / plastique, blanc, chrome

H 60, Ø 410



20W 2400lm



9 002759 956790

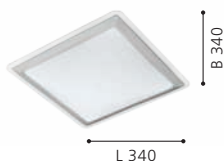

9 002759 956820



9 002759 956844





96023



900149



900335



96023 CAPASSO

wall/ceiling light; steel, white / plastic, white, chrome
Wand- / Deckenleuchte; Stahl, weiss / Kunststoff, weiss, chrom
Applique/Plafonnier; acier, blanc / plastique, blanc, chrome

H 65, Ø 340

LED

warm
WHITE
2200lm



18W

2200lm

900149 CAPASSO

wall/ceiling light; steel, white / plastic, white, black
Wand- / Deckenleuchte; Stahl, weiss / Kunststoff, weiss, schwarz
Applique/Plafonnier; acier, blanc / plastique, blanc, noir

H 60, Ø 340

LED

warm
WHITE
1600lm



14,6W

1600lm

900335 CAPASSO

wall/ceiling light; steel, white / plastic, white, black
Wand- / Deckenleuchte; Stahl, weiss / Kunststoff, weiss, schwarz
Applique/Plafonnier; acier, blanc / plastique, blanc, noir

H 60, Ø 480

LED

warm
WHITE
2200lm



19,5W

2200lm



9 002759 960230



9 008606 243471



9 008606 243488

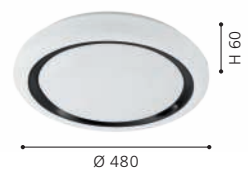



900612

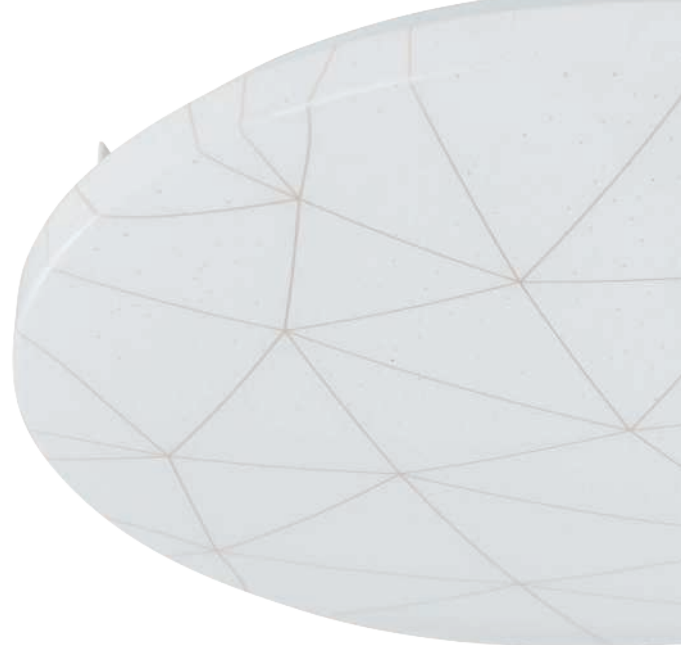

900613



900612 RENDE

ceiling light; steel, white / plastic, white, gold
Deckenleuchte; Stahl, weiss / Kunststoff, weiss, gold
plafonnier; acier, blanc / plastique, blanc, or

H 60, Ø 380



19,5W 2300lm

900613 RENDE

ceiling light; steel, white / plastic, white, silver
Deckenleuchte; Stahl, weiss / Kunststoff, weiss, silber
plafonnier; acier, blanc / plastique, blanc, argent

L 380, B 380, H 60



19,5W 2300lm



9 008606 245093

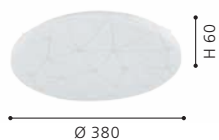

9 008606 245109





900498

LED



900499

LED



900501

LED



900498 NIEVES 1

wall/ceiling light; steel, white / plastic, white, gold
Wand- / Deckenleuchte; Stahl, weiss / Kunststoff, weiss, gold
Applique/Plafonnier; acier, blanc / plastique, blanc, or

H 60, Ø 310

LED

warm
WHITE
1100lm



900499 NIEVES 1

wall/ceiling light; steel, white / plastic, white, gold
Wand- / Deckenleuchte; Stahl, weiss / Kunststoff, weiss, gold
Applique/Plafonnier; acier, blanc / plastique, blanc, or

H 65, Ø 410

LED

warm
WHITE
2300lm



900501 NIEVES 1

wall/ceiling light; steel, white / plastic, white, gold
Wand- / Deckenleuchte; Stahl, weiss / Kunststoff, weiss, gold
Applique/Plafonnier; acier, blanc / plastique, blanc, or

H 70, Ø 510

LED

warm
WHITE
3710lm



9 008606 239634



9 008606 239641



9 008606 239658

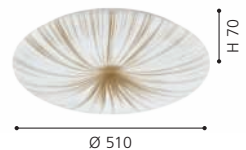



99699

LED



98325

LED

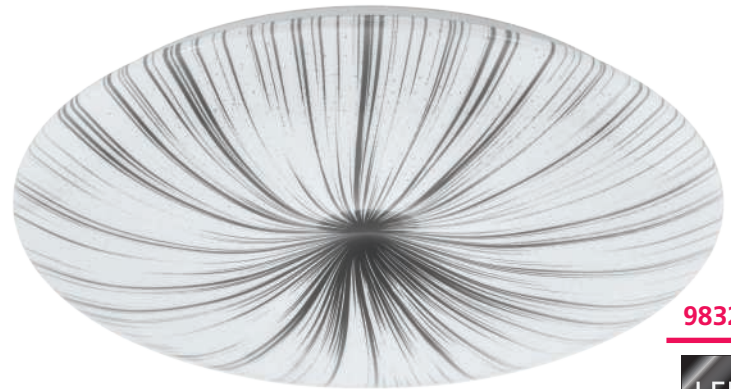

98326

LED

99699 NIEVES

wall/ceiling light; steel, white / plastic, white, silver
Wand- / Deckenleuchte; Stahl, weiss / Kunststoff, weiss, silber
Applique/Plafonnier; acier, blanc / plastique, blanc, argent

H 60, Ø 310



10W 1100lm

98325 NIEVES

wall/ceiling light; steel, white / plastic, white, silver
Wand- / Deckenleuchte; Stahl, weiss / Kunststoff, weiss, silber
Applique/Plafonnier; acier, blanc / plastique, blanc, argent

H 65, Ø 410



19,5W 2300lm

98326 NIEVES

wall/ceiling light; steel, white / plastic, white, silver
Wand- / Deckenleuchte; Stahl, weiss / Kunststoff, weiss, silber
Applique/Plafonnier; acier, blanc / plastique, blanc, argent

H 70, Ø 510



7x 4,4W 3710lm



9 002759 996994

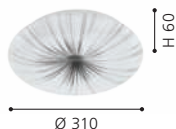

9 002759 983253

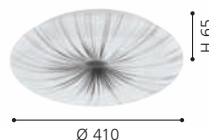

9 002759 983260

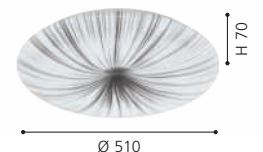



99406



99407



98603



99406 PESCAITO

wall/ceiling light; steel, black / plastic, white, gold
Wand- / Deckenleuchte; Stahl, schwarz / Kunststoff, weiss, gold
Applique/Plafonnier; acier, noir / plastique, blanc, or

H 65, Ø 280



10W



1100lm



99407 PESCAITO

wall/ceiling light; steel, black / plastic, white, gold
Wand- / Deckenleuchte; Stahl, schwarz / Kunststoff, weiss, gold
Applique/Plafonnier; acier, noir / plastique, blanc, or

H 65, Ø 380



19,5W



2300lm



98603 MUSURITA

ceiling light; plastic, steel, black / plastic, white
Deckenleuchte; Kunststoff, Stahl, schwarz / Kunststoff, weiss
plafonnier; plastique, acier, noir / plastique, blanc

H 60, Ø 340



14,6W



1600lm



9 002759 994068

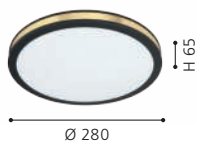

9 002759 994075

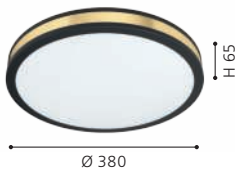

9 002759 986032





98604



98601



98602



98604 MUSURITA

ceiling light; plastic, steel, black / plastic, white
 Deckenleuchte; Kunststoff, Stahl, schwarz / Kunststoff, weiss
 plafonnier; plastique, acier, noir / plastique, blanc

H 75, Ø 440



6x 5,5 W 3600 lm

98601 MUSURITA

ceiling light; plastic, steel, natural wooden effect / plastic, white
 Deckenleuchte; Kunststoff, Stahl, Holzoptik natur / Kunststoff, weiss
 plafonnier; plastique, acier, aspect bois naturel / plastique, blanc

H 60, Ø 340



14,6 W 1600 lm

98602 MUSURITA

ceiling light; plastic, steel, natural wooden effect / plastic, white
 Deckenleuchte; Kunststoff, Stahl, Holzoptik natur / Kunststoff, weiss
 plafonnier; plastique, acier, aspect bois naturel / plastique, blanc

H 75, Ø 440



6x 5,5 W 3600 lm



9 002759 986049



9 002759 986018



9 002759 986025

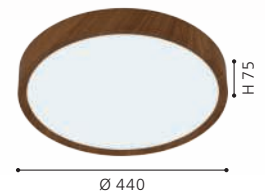



99782



99783



99779



99782 LAURITO

ceiling light; steel, white / plastic, grey, white
Deckenleuchte; Stahl, weiss / Kunststoff, grau, weiss
plafonnier; acier, blanc / plastique, gris, blanc

H 70, Ø 490



24W



2600lm



Remote

99783 LAURITO

ceiling light; steel, white / plastic, black, white
Deckenleuchte; Stahl, weiss / Kunststoff, schwarz, weiss
plafonnier; acier, blanc / plastique, noir, blanc

H 70, Ø 490



24W



2600lm



Remote

99779 SELUCI

ceiling light; steel, white / plastic, white, clear
Deckenleuchte; Stahl, weiss / Kunststoff, weiss, klar
plafonnier; acier, blanc / plastique, blanc, transparent

H 80, Ø 490



4x 10W



4600lm



Remote



9 002759 997823



9 002759 997830



9 002759 997793





99781

LED

incl./inkl./inclus



99781 SELUCI

ceiling light; steel, black / plastic, white, clear
Deckenleuchte; Stahl, schwarz / Kunststoff, weiss, klar
plafonnier; acier, noir / plastique, blanc, transparent

H 80, Ø 490



4x 10W



4600lm



Remote



9 002759 997816



SELUCI

Convenient light effect due to the indirect illumination.

Angenehmer Lichteffect durch indirekte Beleuchtung.

Effet de lumière pratique en raison de l'éclairage indirect.



99623

LED

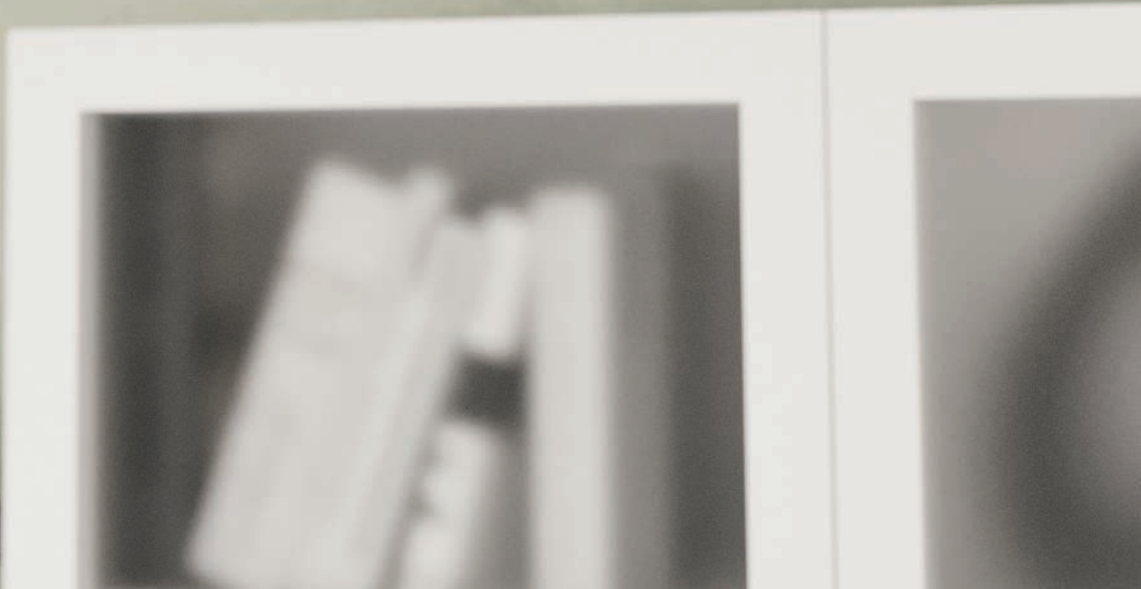



99623 VALCASOTTO

ceiling light; steel, mocha-coloured / plastic, white
 Deckenleuchte; Stahl, Mokkafarben / Kunststoff, weiss
 plafonnier; acier, café / plastique, blanc

H 75, Ø 370



99621 VALCASOTTO

ceiling light; steel, black / plastic, white
 Deckenleuchte; Stahl, schwarz / Kunststoff, weiss
 plafonnier; acier, noir / plastique, blanc

H 75, Ø 370



99622 VALCASOTTO

ceiling light; steel, brown / plastic, white
 Deckenleuchte; Stahl, braun / Kunststoff, weiss
 plafonnier; acier, marron / plastique, blanc

H 75, Ø 370

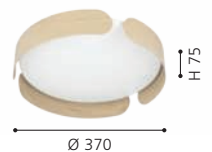
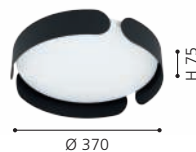



900795



900796



900795 LUPPINERIA

ceiling light; steel, black / plastic, white
 Deckenleuchte; Stahl, schwarz / Kunststoff, weiss
 plafonnier; acier, noir / plastique, blanc

H 95, Ø 385



900796 LUPPINERIA

ceiling light; steel, matte brass / plastic, white
 Deckenleuchte; Stahl, messing-matt / Kunststoff, weiss
 plafonnier; acier, laiton mat / plastique, blanc

H 95, Ø 385

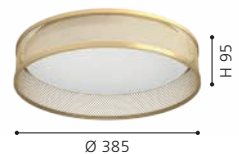



900463



900464



900463 LUPPINERIA

ceiling light; steel, plastic, sandy, white / wood, brown
Deckenleuchte; Stahl, Kunststoff, sandfarben, weiss / Holz, braun
plafonnier; acier, plastique, couleur sable, blanc / bois, marron

H 80, Ø 380



20W 2400lm



9 008606 244027



900464 LUPPINERIA

ceiling light; plastic, steel, white / wood, brown
Deckenleuchte; Kunststoff, Stahl, weiss / Holz, braun
plafonnier; plastique, acier, blanc / bois, marron

H 80, Ø 380



20W 2400lm



9 008606 244034

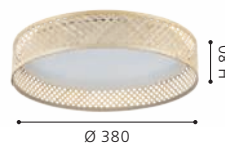



900797



900857



900797 LUPPINERIA

ceiling light; wood, steel, brown, white / plastic, white
Deckenleuchte; Holz, Stahl, braun, weiss / Kunststoff, weiss
plafonnier; bois, acier, marron, blanc / plastique, blanc

H 95, Ø 450



9 008606 267019

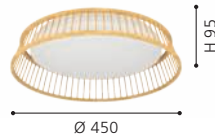

900857 PENJAMO 1

ceiling light; steel, wood, black, brown / plastic, white
Deckenleuchte; Stahl, Holz, schwarz, braun / Kunststoff, weiss
plafonnier; acier, bois, noir, marron / plastique, blanc

H 65, Ø 465



9 008606 271207





99703



99704



99703 PENJAMO

ceiling light; steel, black / plastic with crystal effect, white
Deckenleuchte; Stahl, schwarz / Kunststoff m. Kristalleffekt, weiss
plafonnier; acier, noir / plastique avec effet cristal, blanc

H 60, Ø 465



3x 7,3W 2010lm

99704 PENJAMO

ceiling light; steel, mocha-coloured / plastic with crystal effect, white
Deckenleuchte; Stahl, Mokkafarben / Kunststoff m. Kristalleffekt, weiss
plafonnier; acier, café / plastique avec effet cristal, blanc

H 60, Ø 465



3x 7,3W 2010lm



9 002759 997038



9 002759 997045





900601

LED

incl./inkl./inclus



900601 CALAGRANO

ceiling light; steel, black / plastic, white
Deckenleuchte; Stahl, schwarz / Kunststoff, weiss
plafonnier; acier, noir / plastique, blanc

H 60, Ø 380

LED

11,5W

tunable
WHITE

1500lm

LED

10W

tunable
WHITE

1400lm





900602



incl./inkl./inclus



900863



900864



900602 CALAGRANO

ceiling light; steel, black / plastic, white
Deckenleuchte; Stahl, schwarz / Kunststoff, weiss
plafonnier; acier, noir / plastique, blanc

L 375, B 375, H 60



11 W 1600 lm 10 W 1400 lm



9 008606 245000

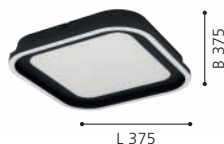

L 375

900863 PALAGIANO

ceiling light; steel, white / plastic, steel, satin finish, white
Deckenleuchte; Stahl, weiss / Kunststoff, Stahl, satiniert, weiss
plafonnier; acier, blanc / plastique, acier, satiné, blanc

H 55, Ø 300



14,7 W 2100 lm



9 008606 264087



Ø 300

900864 PALAGIANO

ceiling light; steel, white / plastic, steel, satin finish, white
Deckenleuchte; Stahl, weiss / Kunststoff, Stahl, satiniert, weiss
plafonnier; acier, blanc / plastique, acier, satiné, blanc

H 55, Ø 380



21 W 3100 lm



9 008606 264094



Ø 380



32051



32052



32053



32051 PALAGIANO 1

ceiling light; steel, white / plastic, steel, satin finish, white
Deckenleuchte; Stahl, weiss / Kunststoff, Stahl, satiniert, weiss
plafonnier; acier, blanc / plastique, acier, satiné, blanc

H 50, Ø 300



14,7W 2100lm

32052 PALAGIANO 1

ceiling light; steel, white / plastic, steel, satin finish, white
Deckenleuchte; Stahl, weiss / Kunststoff, Stahl, satiniert, weiss
plafonnier; acier, blanc / plastique, acier, satiné, blanc

H 50, Ø 380



14,7W 2200lm

32053 PALAGIANO 1

ceiling light; steel, white / plastic, steel, satin finish, white
Deckenleuchte; Stahl, weiss / Kunststoff, Stahl, satiniert, weiss
plafonnier; acier, blanc / plastique, acier, satiné, blanc

H 50, Ø 480



21W 3200lm



9 002759 320515

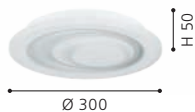

9 002759 320522

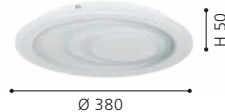

9 002759 320539

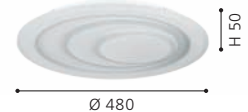



99397



99398



99397 MENTALURGIA

wall/ceiling light; steel, white, chrome / plastic, white
Wand- / Deckenleuchte; Stahl, weiss, chrom / Kunststoff, weiss
Applique/Plafonnier; acier, blanc, chrome / plastique, blanc

L 495, B 465, H 65

LED 11W	tunable WHITE 1400lm	LED 9,8W	tunable WHITE 1300lm	LED 8,5W	tunable WHITE 1250lm
LED 6W	tunable WHITE 850lm	LED 5W	tunable WHITE 600lm	LED	LED



9 002759 993979



99398 MENTALURGIA

wall/ceiling light; steel, white, chrome / plastic, white
Wand- / Deckenleuchte; Stahl, weiss, chrom / Kunststoff, weiss
Applique/Plafonnier; acier, blanc, chrome / plastique, blanc

L 490, B 490, H 65

LED 12W	tunable WHITE 1750lm	LED 11W	tunable WHITE 1600lm	LED 7,5W	tunable WHITE 1050lm
LED 5,5W	tunable WHITE 750lm	LED 4,4W	tunable WHITE 550lm	LED	LED



9 002759 993986



MENTALURGIA

The light color of the luminaires can be controlled via the wall switch.

Über den Wandschalter kann die Lichtfarbe der Leuchten gesteuert werden.

L'interrupteur mural permet de contrôler la couleur de la lumière des luminaires.



81635



83404



81636

81635 ELLA

wall/ceiling light; steel, white / matte-opal glass, white
Wand- / Deckenleuchte; Stahl, weiss / Glas opal-matt, weiss
Applique/Plafonnier; acier, blanc / verre opale mat, blanc

H 92, Ø 200



E27



1x 60W

81636 ELLA

wall/ceiling light; steel, white / matte-opal glass, white
Wand- / Deckenleuchte; Stahl, weiss / Glas opal-matt, weiss
Applique/Plafonnier; acier, blanc / verre opale mat, blanc

H 117, Ø 280



E27



1x 60W

83404 ELLA

wall/ceiling light; steel, white / matte-opal glass, white
Wand- / Deckenleuchte; Stahl, weiss / Glas opal-matt, weiss
Applique/Plafonnier; acier, blanc / verre opale mat, blanc

H 127, Ø 350



E27



2x 60W



9 002759 816353

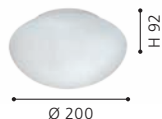

9 002759 816360



9 002759 834043





94973

94973 DURELO

ceiling light; plastic, white / glass, white
Deckenleuchte; Kunststoff, weiss / Glas, weiss
plafonnier; plastique, blanc / verre, blanc

H 195, Ø 160



E27



1x 28W



9 002759 949730





82942



83155



83153

82942 PLANET

wall/ceiling light; steel, satin nickel / satin glass, white, clear
Wand- / Deckenleuchte; Stahl, nickel-matt / Glas satiniert, weiss, klar
Applique/Plafonnier; acier, nickel mat / verre satiné, blanc, transparent

H 85, Ø 290



E27

1x 25W

83155 PLANET 1

wall/ceiling light; steel, chrome / painted glass, white, clear
Wand- / Deckenleuchte; Stahl, chrom / Glas lackiert, weiss, klar
Applique/Plafonnier; acier, chrome / verre laqué, blanc, transparent

H 85, Ø 290



E27

1x 25W

83153 PLANET 1

wall/ceiling light; steel, white / painted glass, white, clear
Wand- / Deckenleuchte; Stahl, weiss / Glas lackiert, weiss, klar
Applique/Plafonnier; acier, blanc / verre laqué, blanc, transparent

H 85, Ø 290



E27

1x 25W



9 002759 829421



Ø 290



9 002759 831554



Ø 290



9 002759 831530



Ø 290



83156



83154

83156 PLANET 1

wall light; steel, chrome / painted glass, white, clear
 Wandleuchte; Stahl, chrom / Glas lackiert, weiss, klar
 Applique; acier, chrome / verre laqué, blanc, transparent

L 290, H 145, A 85



83154 PLANET 1

wall light; steel, white / painted glass, white, clear
 Wandleuchte; Stahl, weiss / Glas lackiert, weiss, klar
 Applique; acier, blanc / verre laqué, blanc, transparent

L 290, H 145, A 85



9 002759 831561



9 002759 831547





83157



83159

83157 PLANET 1

wall/ceiling light; steel, brass / painted glass, white, clear
Wand- / Deckenleuchte; Stahl, messing / Glas lackiert, weiss, klar
Applique/Plafonnier; acier, laiton / verre laqué, blanc, transparent

H 85, Ø 290



E27



1x 25W



9 002759 831578



Ø 290

83159 PLANET 1

wall/ceiling light; steel, black / painted glass, white, clear
Wand- / Deckenleuchte; Stahl, schwarz / Glas lackiert, weiss, klar
Applique/Plafonnier; acier, noir / verre laqué, blanc, transparent

H 85, Ø 290



E27



1x 25W



9 002759 831592



Ø 290

83162 PLANET 1

wall/ceiling light; steel, satin nickel / painted glass, white, clear
Wand- / Deckenleuchte; Stahl, nickel-matt / Glas lackiert, weiss, klar
Applique/Plafonnier; acier, nickel mat / verre laqué, blanc, transparent

H 85, Ø 290



E27



1x 25W



9 002759 831622



Ø 290



83162



83163

83163 PLANET 1

wall light; steel, satin nickel / painted glass, white, clear
Wandleuchte; Stahl, nickel-matt / Glas lackiert, weiss, klar
Applique; acier, nickel mat / verre laqué, blanc, transparent

L 290, H 145, A 85



E27



1x 60W



9 002759 831639

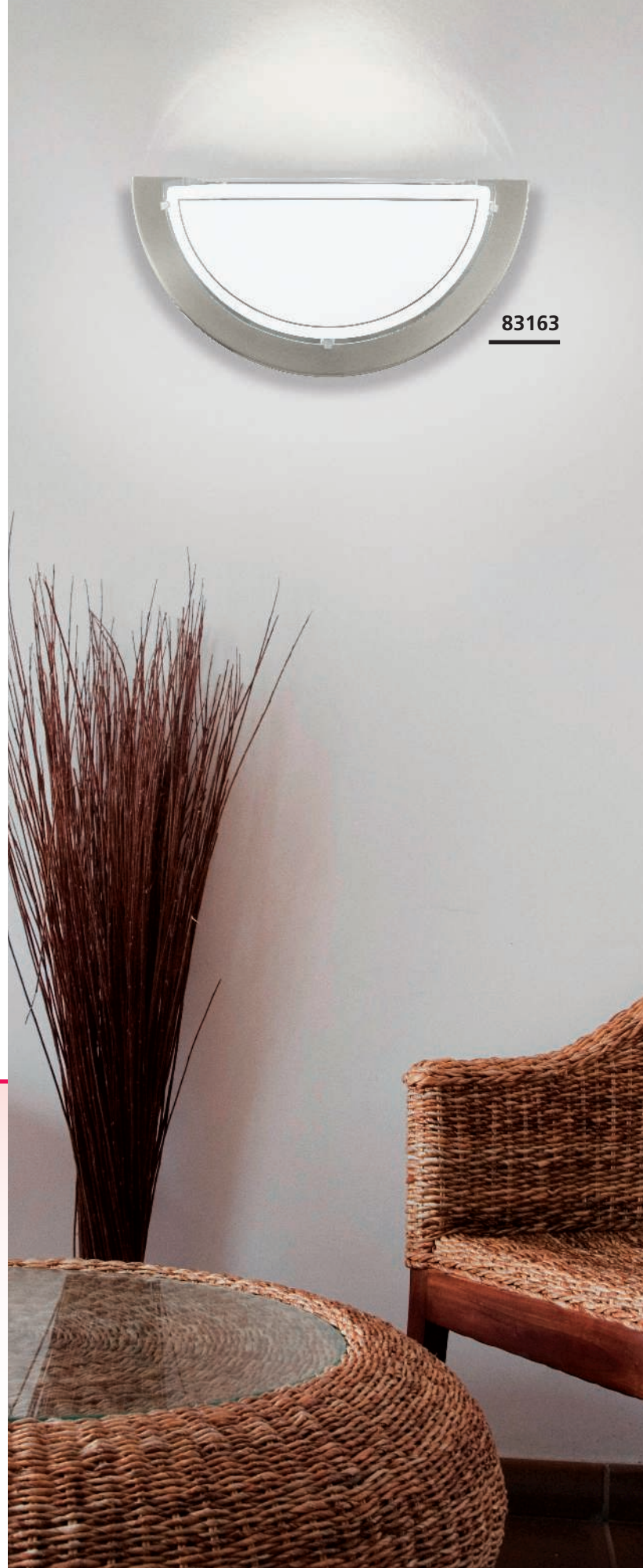



96117

LED





96111

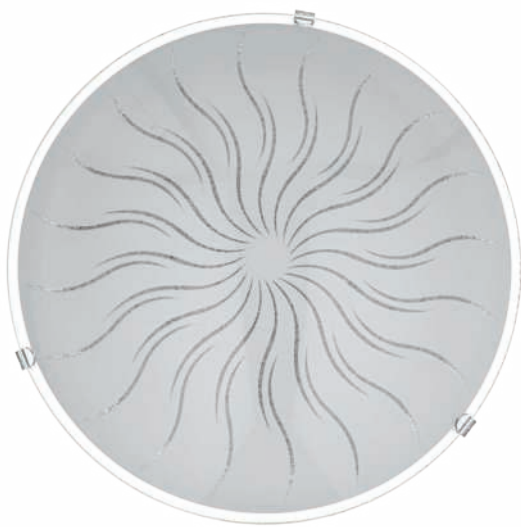

96089



96117 MARGITTA 1

wall/ceiling light; steel, white / glass, white, black, clear
Wand- / Deckenleuchte; Stahl, weiss / Glas, weiss, schwarz, klar
Applique/Plafonnier; acier, blanc / verre, blanc, noir, transparent

H 95, Ø 315



3x 3,6W 1110lm



9 002759 961176



Ø 315

96089 MARGITTA 1

wall/ceiling light; steel, white / glass, white granules, clear
Wand- / Deckenleuchte; Stahl, weiss / Glas, granille weiss, klar
Applique/Plafonnier; acier, blanc / verre, blanc granille, transparent

H 70, Ø 250



3x 3,6W 960lm



9 002759 960896



Ø 250

96111 MARGITTA 1

wall/ceiling light; steel, white / glass, white granules, clear
Wand- / Deckenleuchte; Stahl, weiss / Glas, granille weiss, klar
Applique/Plafonnier; acier, blanc / verre, blanc granille, transparent

H 95, Ø 315



3x 3,6W 960lm



9 002759 961114



Ø 315



89248

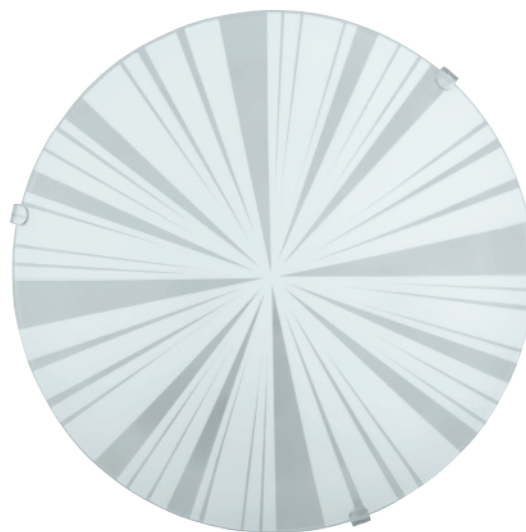

89239

89248 MARS 1

wall/ceiling light; steel, white / satin glass, white, silver
 Wand- / Deckenleuchte; Stahl, weiss / Glas satiniert, weiss, silber
 Applique/Plafonnier; acier, blanc / verre satiné, blanc, argent

H 70, Ø 250



E27



1x 25W



9 002759 892487



Ø 250

89239 MARS 1

wall/ceiling light; steel, white / satin glass, sunbeam motif
 Wand- / Deckenleuchte; Stahl, weiss / Glas satiniert, Motiv Strahlen
 Applique/Plafonnier; acier, blanc / verre satiné, motif «rayons»

H 70, Ø 250



E27



1x 25W



9 002759 892395

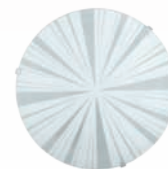

Ø 250



80263



80264



89238

80264 MARS

wall/ceiling light; steel, white / satin glass, leaf motif
Wand- / Deckenleuchte; Stahl, weiss / Glas satiniert, Motiv Blätter
Applique/Plafonnier; acier, blanc / verre satiné, motif «feuilles»

H 70, Ø 250



E27 1x 25W



9 002759 802646



Ø 250

80263 MARS

wall/ceiling light; steel, white / satin glass, triangle motif
Wand- / Deckenleuchte; Stahl, weiss / Glas satiniert, Motiv Dreiecke
Applique/Plafonnier; acier, blanc / verre satiné, motif «triangles»

H 70, Ø 250



E27 1x 25W



9 002759 802639



Ø 250

89238 MARS 1

wall/ceiling light; steel, white / satin glass, rose motif
Wand- / Deckenleuchte; Stahl, weiss / Glas satiniert, Motiv Rose
Applique/Plafonnier; acier, blanc / verre satiné, motif «rose»

H 70, Ø 250



E27 1x 25W



9 002759 892388



Ø 250



80265



7186



7184

80265 MARS

wall/ceiling light; steel, white / satin glass, white
Wand- / Deckenleuchte; Stahl, weiss / Glas satiniert, weiss
Applique/Plafonnier; acier, blanc / verre satiné, blanc

H 70, Ø 250



E27

1x 25W



9 002759 802653



Ø 250

7186 SALOME

wall/ceiling light; steel, chrome / alabaster glass, white
Wand- / Deckenleuchte; Stahl, chrom / Glas alabaster, weiss
Applique/Plafonnier; acier, chrome / verre albâtre, blanc

H 90, Ø 300



E27

1x 25W



9 002759 718602



Ø 300

7184 SALOME

wall/ceiling light; steel, chrome / alabaster glass, white
Wand- / Deckenleuchte; Stahl, chrom / Glas alabaster, weiss
Applique/Plafonnier; acier, chrome / verre albâtre, blanc

H 110, Ø 400



E27

2x 25W



9 002759 718404



Ø 400



7188

7188 SALOME

wall light; steel, chrome / alabaster glass, white
Wandleuchte; Stahl, chrom / Glas alabaster, weiss
Applique; acier, chrome / verre albâtre, blanc

L 300, H 150, A 90



E27



1x 60W



9 002759 718800



SALOME

These luminaires have a beautiful alabaster glass.

Diese Leuchten besitzen ein wunderschönes Alabasterglas.

Ces luminaires ont un beau verre d'albâtre.





95672



90043



95672 MAGITTA 1

wall/ceiling light; steel, white / glass, white, clear
Wand- / Deckenleuchte; Stahl, weiss / Glas, weiss, klar
Applique/Plafonnier; acier, blanc / verre, blanc, transparent

H 80, Ø 250



3x 3,6W



1110lm



90043 SCALEA 1

wall/ceiling light; steel, white / satin glass, white with decoration
Wand- / Deckenleuchte; Stahl, weiss / Glas satiniert, weiss m.Dekor
Applique/Plafonnier; acier, blanc / verre satiné, blanc avec décor

H 100, Ø 315



E27



1x 25W



9 002759 956721



Ø 250



9 002759 900434



Ø 315



83132



83119



84028

83132 GRAFIK

wall/ceiling light; steel / satin glass, line motif
Wand- / Deckenleuchte; Stahl / Glas satiniert, Motiv Linien
Applique/Plafonnier; acier / verre satiné, motif «lignes»

L 180, H 210, A 85

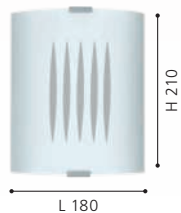

84028 GRAFIK

wall/ceiling light; steel, silver / satin glass, white
Wand- / Deckenleuchte; Stahl, silber / Glas satiniert, weiss
Applique/Plafonnier; acier, argent / verre satiné, blanc

L 180, H 210, A 85

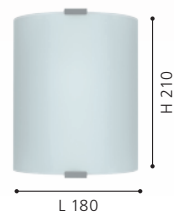

83119 NEMO

wall light; steel, satin nickel / matte-opal glass, white
Wandleuchte; Stahl, nickel-matt / Glas opal-matt, weiss
Applique; acier, nickel mat / verre opale mat, blanc

L 150, H 320, A 95





DESIGN
HIGHLIGHT
DETAIL



82741



86712

86712 MESTRE

wall/ceiling light; steel, antique brown, gold / chalked glass, beige
 Wand- / Deckenleuchte; Stahl, antik-braun, gold / Glas gekalkt, beige
 Applique/Plafonnier; acier, marron antique, or / verre chaulé, beige
 H 133, Ø 395



82741 IMPERIAL

wall/ceiling light; cast metal, bronzed / satin glass, white
 Wand- / Deckenleuchte; Metallguss, brüniert / Glas satiniert, weiss
 Applique/Plafonnier; fonte métallique, brun / verre satiné, blanc
 H 140, Ø 310





89115



86715



87793

89115 ALMERA

wall light; steel, antique brown / glass, champagne
Wandleuchte; Stahl, antik-braun / Glas, champagner
Applique; acier, marron antique / verre, champagne

L 180, H 250, A 75



E14

1x 60W



9 002759 891152



86715 MESTRE

wall light; steel, antique brown, gold / chalked glass, beige
Wandleuchte; Stahl, antik-braun, gold / Glas gekalkt, beige
Applique; acier, marron antique, or / verre chaulé, beige

L 300, H 335, A 160



E27

1x 60W



9 002759 867157



87793 PASCAL 1

wall light; steel, antique brown / chalked glass, beige
Wandleuchte; Stahl, antik-braun / Glas gekalkt, beige
Applique; acier, marron antique / verre chaulé, beige

L 180, H 480, A 120



E14

1x 60W



9 002759 877934





90737



90737, 90697

Rustic luminaire series with appealing leaf decor

Rustikale Leuchtenserie mit ansprechendem Blätterdekor

Série de luminaires rustique avec un décor de feuille plaisant



90697

90737 CAMPANIA

ceiling light; steel, antique brown, gold / chalked glass, white
Deckenleuchte; Stahl, antik-braun, gold / Glas gekalkt, weiss
plafonnier; acier, marron antique, or / verre chaulé, blanc

H 115, Ø 775



G4 15x 10W

90697 GERBERA 1

ceiling light; steel, antique brown, gold / satin glass, white
Deckenleuchte; Stahl, antik-braun, gold / Glas satiniert, weiss
plafonnier; acier, marron antique, or / verre satiné, blanc

H 90, Ø 780



G9 6x 33W

92143 COLTI

ceiling light; steel, antique brown / satin glass, white painted
Deckenleuchte; Stahl, antik-braun / Glas satiniert, weiss lackiert
plafonnier; acier, marron antique / verre satiné, blanc laqué

H 95, Ø 350



E27 2x 25W



9 002759 907372



Ø 775



9 002759 906979



Ø 780



9 002759 921439



Ø 350



92143





97886



99348

Matching fabric luminaires
can be found from page 130.

Passende Stoffleuchten finden
Sie ab Seite 130.

Vous trouverez les luminaires à tissu
assorties à partir de la page 130.

97886 SAN PERI

wall light; steel, black
Wandleuchte; Stahl, schwarz
Applique; acier, noir

L 130, B 300, H 210



E27 1x 10W



9 002759 978860



99348 STAITI 1

wall light; steel, black / fabric, black
Wandleuchte; Stahl, schwarz / Textil, schwarz
Applique; acier, noir / tissu, noir

L 160, H 240, A 500

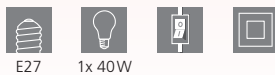

E27 1x 40W



9 002759 993481

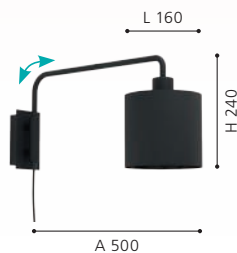



99348



96567

LED

TAZZOLI

These luminaires have a USB-connection.

Diese Leuchten verfügen über einen USB-Anschluss.

Ces luminaires disposent d'une connexion USB.



96566

LED



98263

LED

96567 TAZZOLI

wall light; steel, plastic, satin nickel, black
Wandleuchte; Stahl, Kunststoff, nickel-matt, schwarz
Applique; acier, plastique, nickel mat, noir

L 65, H 300, A 160



3,8W 320lm



9 002759 965679



96566 TAZZOLI

wall light; steel, plastic, white
Wandleuchte; Stahl, Kunststoff, weiss
Applique; acier, plastique, blanc

L 65, H 300, A 160



3,8W 320lm



9 002759 965662



98263 CIGLIE

wall light; aluminium, steel, black
Wandleuchte; Alu, Stahl, schwarz
Applique; aluminium, acier, noir

L 180, H 180, A 210



3,8W 320lm



9 002759 982638



INCL.

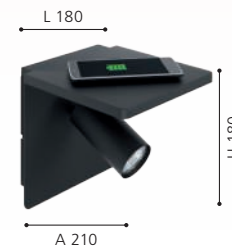



99595

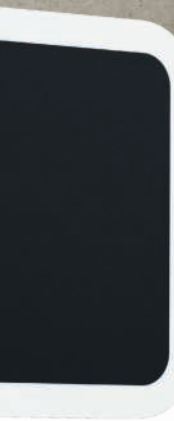

99595

99595 CARTIGNANO

wall light; steel, black / plastic, white
Wandleuchte; Stahl, schwarz / Kunststoff, weiss
Applique; acier, noir / plastique, blanc

L 780, H 180, A 35

LED

7,8W

warm
WHITE

900lm



These simple, modern luminaires serve not only as a source of light, but also as a wardrobe. They can be mounted directly in the wall outlet, a cable with switch is automatically supplied.

Diese schlichten, modernen Leuchten dienen nicht nur als Lichtquelle, sondern auch als Garderobe. Sie können direkt im Wandauslass montiert werden, ein Kabel mit Schalter wird automatisch mitgeliefert.

Ces luminaires sobres et modernes ne servent pas seulement de source de lumière, mais aussi de portemanteau. Ils peuvent être montés directement dans le diffuseur mural, un câble avec interrupteur est automatiquement fourni.

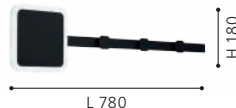



99596



99596 CIVITATE

wall light; steel, wood, black, brown
Wandleuchte; Stahl, Holz, schwarz, braun
Applique; acier, bois, noir, marron

L 760, B 100, H 85



18W



1900lm



9 002759 995966



99596

LED wall luminaires CIVITATE consist of a rectangular black metal body with rounded corners. Thanks to the five holders made of brown rubber wood, the wall luminaires offer enough space for jackets as well as coats and can thus be optimally used as an illuminated coat rack. The luminaires provide pleasant warm white light, creating indirect lighting in the entrance area. The minimalist luminaires round off modern interior styles and are conveniently switched on and off via a switch on the cable.

Die LED Wandleuchten CIVITATE bestehen aus einem rechteckigen, schwarzen Metall-Körper mit abgerundeten Ecken. Dank der fünf Halterungen aus braunem Gummibaumholz bieten die Wandlampen genügend Platz für Jacken sowie Mäntel und kann so optimal als beleuchtete Garderobe genutzt werden. Die Leuchten spenden angenehmes warmweißes Licht und schaffen so eine indirekte Beleuchtung im Eingangsbereich. Die minimalistischen Leuchten runden moderne Einrichtungsstile ab und sind bequem über einen Schalter am Kabel ein- und ausschaltbar.

Les appliques LED CIVITATE se composent d'un corps rectangulaire en métal noir aux coins arrondis. Grâce aux cinq supports en bois d'hévéa brun, les appliques offrent suffisamment de place pour les vestes et les manteaux et peuvent ainsi être utilisées de manière optimale comme portemanteau éclairé. Les luminaires diffusent une agréable lumière blanche chaude et créent ainsi un éclairage indirect dans la zone d'entrée. Les luminaires minimalistes complètent les styles d'aménagement modernes et s'allument et s'éteignent facilement grâce à un interrupteur sur le câble.



900525

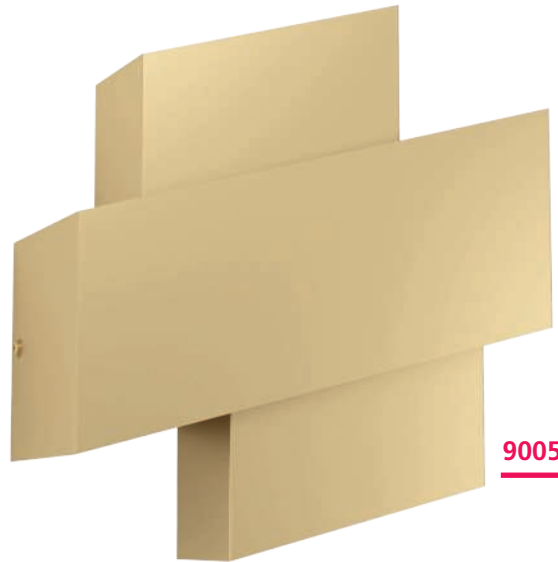

900526

900525 TIMPAROSSA

wall light; steel, white
Wandleuchte; Stahl, weiss
Applique; acier, blanc

L 255, H 220, A 105



E27



1x 40W



9 008606 244539

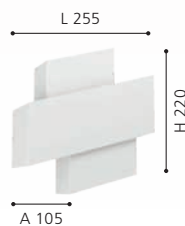

900526 TIMPAROSSA

wall light; steel, gold-coloured
Wandleuchte; Stahl, goldfarben
Applique; acier, or

L 255, H 220, A 105



E27



1x 40W



9 008606 244546

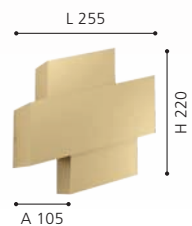



900717

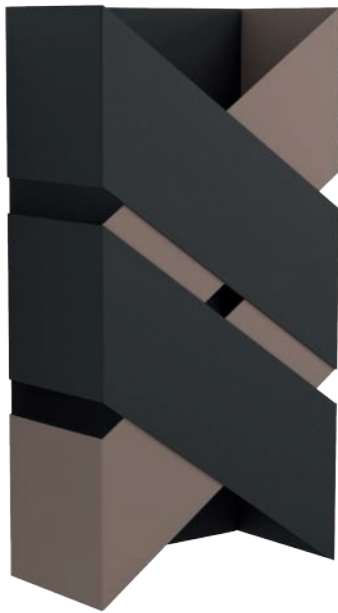

99689



98841



900717 ALAMILO

wall light; steel, white / wood, brown
Wandleuchte; Stahl, weiss / Holz, braun
Applique; acier, blanc / bois, marron

Ø 220, A 35



9,2W



9 008606 256969



99689 GURARE

wall light; steel, black, mocha-coloured
Wandleuchte; Stahl, schwarz, mokkafarben
Applique; acier, noir, café

L 125, H 240, A 85

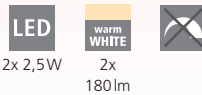

2x 2,5W

2x 180lm



9 002759 996895



98841 ZINACUA

wall light; steel, silver
Wandleuchte; Stahl, silber
Applique; acier, argent

L 225, H 310, A 85



GU10

4x 4,5W

4x 345lm



9 002759 988418

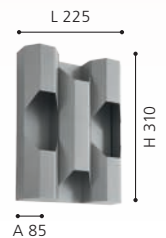



99087



99086



900325



ZUBIALDE

The front panel of the luminaires can be swiveled. Thus, the light pattern can be adjusted individually.

Die Frontplatte der Leuchten ist schwenkbar. Somit kann das Lichtbild individuell eingestellt werden.

La plaque frontale des luminaires est orientable. Ainsi, l'image lumineuse peut être réglée individuellement.



99087 ZUBIALDE

wall light; aluminium, steel, black, white
Wandleuchte; Alu, Stahl, schwarz, weiss
Applique; aluminium, acier, noir, blanc

L 360, H 80, A 50



12W 1550lm



9 002759 990879

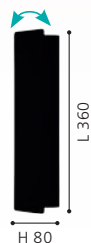

99086 ZUBIALDE

wall light; aluminium, steel, white
Wandleuchte; Alu, Stahl, weiss
Applique; aluminium, acier, blanc

L 360, H 80, A 50



12W 1550lm



9 002759 990862



900325 ZUBIALDE

wall light; steel, wood, black, brown
Wandleuchte; Stahl, Holz, schwarz, braun
Applique; acier, bois, noir, marron

L 360, H 80, A 50



12W 1550lm



9 008606 235360





900871

LED



96049

LED

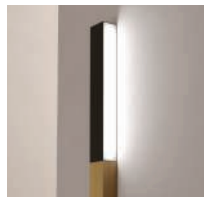

900871

These luminaires can be mounted left or right sideways to the wall. This creates a beautiful grazing light.

Diese Leuchten können links und rechts, seitlich zur Wand montiert werden. Dabei entsteht ein schönes Streiflicht.

Ces luminaires peuvent être montés latéralement à gauche ou à droite du mur. Cela crée une belle lumière rasante.



96048

LED

900871 TUDONS

wall light; aluminium, steel, wood, black, brown
Wandleuchte; Alu, Stahl, Holz, schwarz, braun
Applique; aluminium, acier, bois, noir, marron

L 560, B 60, H 45



1x 12W 1300lm



9 008606 274468

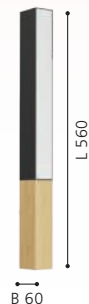

96049 ONO 2

wall light; aluminium, anthracite / plastic, clear
Wandleuchte; Alu, anthrazit / Kunststoff, klar
Applique; aluminium, gris anthracite / plastique, transparent

L 90, H 80, A 130



2x 2,5W 500lm



9 002759 960490



96048 ONO 2

wall light; aluminium, white / plastic, clear
Wandleuchte; Alu, weiss / Kunststoff, klar
Applique; aluminium, blanc / plastique, transparent

L 90, H 80, A 130



2x 2,5W 500lm



9 002759 960483

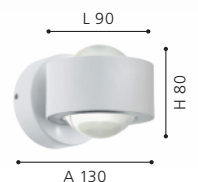



98542



98541



98543



98541 MACCARI

wall light; aluminium, steel, white / plastic, transparent
 Wandleuchte; Alu, Stahl, weiss / Kunststoff, transparent
 Applique; aluminium, acier, blanc / plastique, transparent

L 270, H 75, A 130



98542 MACCARI

wall light; aluminium, steel, black, gold / plastic, transparent
 Wandleuchte; Alu, Stahl, schwarz, gold / Kunststoff, transparent
 Applique; aluminium, acier, noir, or / plastique, transparent

L 270, H 75, A 130

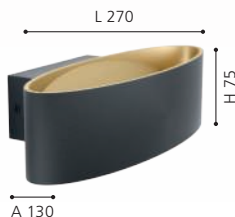

98543 MACCARI

wall light; aluminium, steel, white, satin nickel / plastic, transparent
 Wandleuchte; Alu, Stahl, weiss, nickel-matt / Kunststoff, transparent
 Applique; aluminium, acier, blanc, nickel mat / plastique, transparent

L 270, H 75, A 130

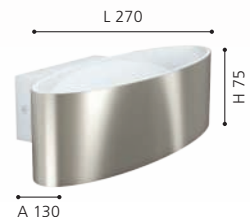



98544



98545



98544 FELONICHE

wall light; aluminium, white / plastic, transparent
 Wandleuchte; Alu, weiss / Kunststoff, transparent
 Applique; aluminium, blanc / plastique, transparent

L 220, H 100, A 75



10W 1300lm



9 002759 985448

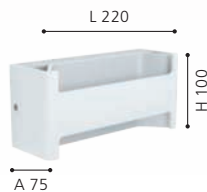

98545 FELONICHE

wall light; aluminium, black, gold / plastic, transparent
 Wandleuchte; Alu, schwarz, gold / Kunststoff, transparent
 Applique; aluminium, noir, or / plastique, transparent

L 220, H 100, A 75



10W 1300lm



9 002759 985455

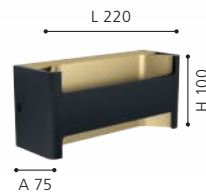



98421



98422



98423



98421 SANIA 4

wall light; aluminium, white
Wandleuchte; Alu, weiss
Applique; aluminium, blanc

L 130, H 80, A 90



6W 670lm



9 002759 984212

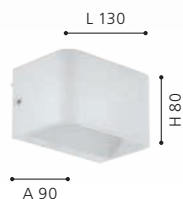

98422 SANIA 4

wall light; aluminium, white
Wandleuchte; Alu, weiss
Applique; aluminium, blanc

L 200, H 80, A 90



10W 1300lm



9 002759 984229

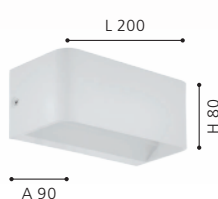

98423 SANIA 4

wall light; aluminium, white
Wandleuchte; Alu, weiss
Applique; aluminium, blanc

L 365, H 80, A 90



12W 1400lm



9 002759 984236

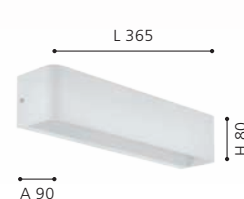



98424

LED



98425

LED



98426

LED

98424 SANIA 4

wall light; aluminium, satin nickel
Wandleuchte; Alu, nickel-matt
Applique; aluminium, nickel mat

L 130, H 80, A 90



6W 670lm

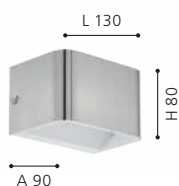

98425 SANIA 4

wall light; aluminium, satin nickel
Wandleuchte; Alu, nickel-matt
Applique; aluminium, nickel mat

L 200, H 80, A 90



10W 1300lm

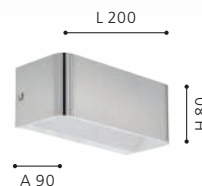

98426 SANIA 4

wall light; aluminium, satin nickel
Wandleuchte; Alu, nickel-matt
Applique; aluminium, nickel mat

L 365, H 80, A 90



12W 1400lm

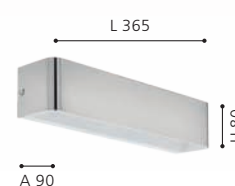

DESIGN
HIGHLIGHT
DETAIL



96261

LED



96264

LED

96261 PASSA

wall light; steel, satin nickel, chrome
Wandleuchte; Stahl, nickel-matt, chrom
Applique; acier, nickel mat, chrome

L 60, H 170, A 85



GU10



2x 3W



warm
WHITE
2x
250lm



9 002759 962616



96264 PASSA

wall light; steel, satin nickel, chrome
Wandleuchte; Stahl, nickel-matt, chrom
Applique; acier, nickel mat, chrome

L 55, H 170, A 85



GU10



2x 3W



warm
WHITE
2x
250lm



9 002759 962647

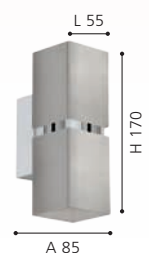



95368

LED



95377

LED



95368 PASSA

wall light; steel, chrome, white
Wandleuchte; Stahl, chrom, weiss
Applique; acier, chrome, blanc

L 60, H 170, A 85



GU10



2x 3W



2x
warm
WHITE
250lm



9 002759 953683



95377 PASSA

wall light; steel, chrome, white
Wandleuchte; Stahl, chrom, weiss
Applique; acier, chrome, blanc

L 55, H 170, A 85



GU10



2x 3W



2x
warm
WHITE
250lm



9 002759 953775





95371

LED



95379

LED

95371 PASSA

wall light; steel, brown, copper
Wandleuchte; Stahl, braun, kupfer
Applique; acier, marron, cuivre

L 60, H 170, A 85

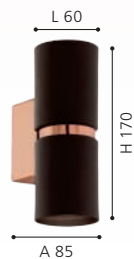
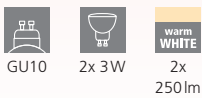

95379 PASSA

wall light; steel, brown, copper
Wandleuchte; Stahl, braun, kupfer
Applique; acier, marron, cuivre

L 55, H 170, A 85

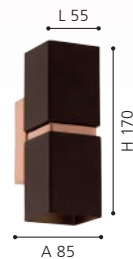
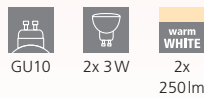

95364 PASSA

wall light; steel, black, gold
Wandleuchte; Stahl, schwarz, gold
Applique; acier, noir, or

L 60, H 170, A 85





95364

LED



95373

LED

95373 PASSA

wall light; steel, black, gold
Wandleuchte; Stahl, schwarz, gold
Applique; acier, noir, or

L 55, H 170, A 85



GU10



2x 3W



warm
WHITE
2x
250lm



9 002759 953737



INCL.

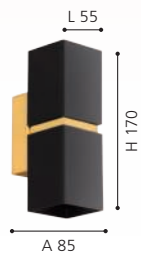



98379



98755



98759

98379 GASCUERIA

wall light; plastic, steel, gold, black
Wandleuchte; Kunststoff, Stahl, gold, schwarz
Applique; plastique, acier, or, noir

L 290, H 330, A 130



E27



1x 60W



L 290



9 002759 983796

98755 ELIZONDO

wall light; steel, black, gold
Wandleuchte; Stahl, schwarz, gold
Applique; acier, noir, or

L 80, H 270, A 115



E14



1x 40W



9 002759 987558

98759 FALICETTO

wall light; steel, black, gold
Wandleuchte; Stahl, schwarz, gold
Applique; acier, noir, or

L 160, H 250, A 115



E27



1x 40W



9 002759 987596



900375

900375 HAYES

wall light; steel, black, gold
 Wandleuchte; Stahl, schwarz, gold
 Applique; acier, noir, or

L 120, H 225, A 120



900375

The golden element of the luminaires can be rotated. This allows the light to be individually adjusted.

Das goldenen Element der Leuchten ist drehbar. Dadurch lässt sich der Lichtschein individuell anpassen.

L'élément doré du luminaires peut être tourné. Cela permet de régler la lumière individuellement.



900343



900518

900343 TANURA

wall light; steel, black
Wandleuchte; Stahl, schwarz
Applique; acier, noir

L 245, H 110, A 105



E27



1x 25W



9 008606 243495

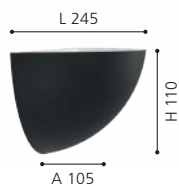

900518 GUANAL

wall light; aluminium, steel, chrome
Wandleuchte; Alu, Stahl, chrom
Applique; aluminium, acier, chrome

L 600, B 50, H 60



E27



4x 40W



9 008606 244478

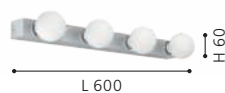

900517 GUANAL

wall light; aluminium, steel, black
Wandleuchte; Alu, Stahl, schwarz
Applique; aluminium, acier, noir

L 600, B 50, H 60



E27



4x 40W



9 008606 244461





900517



30658

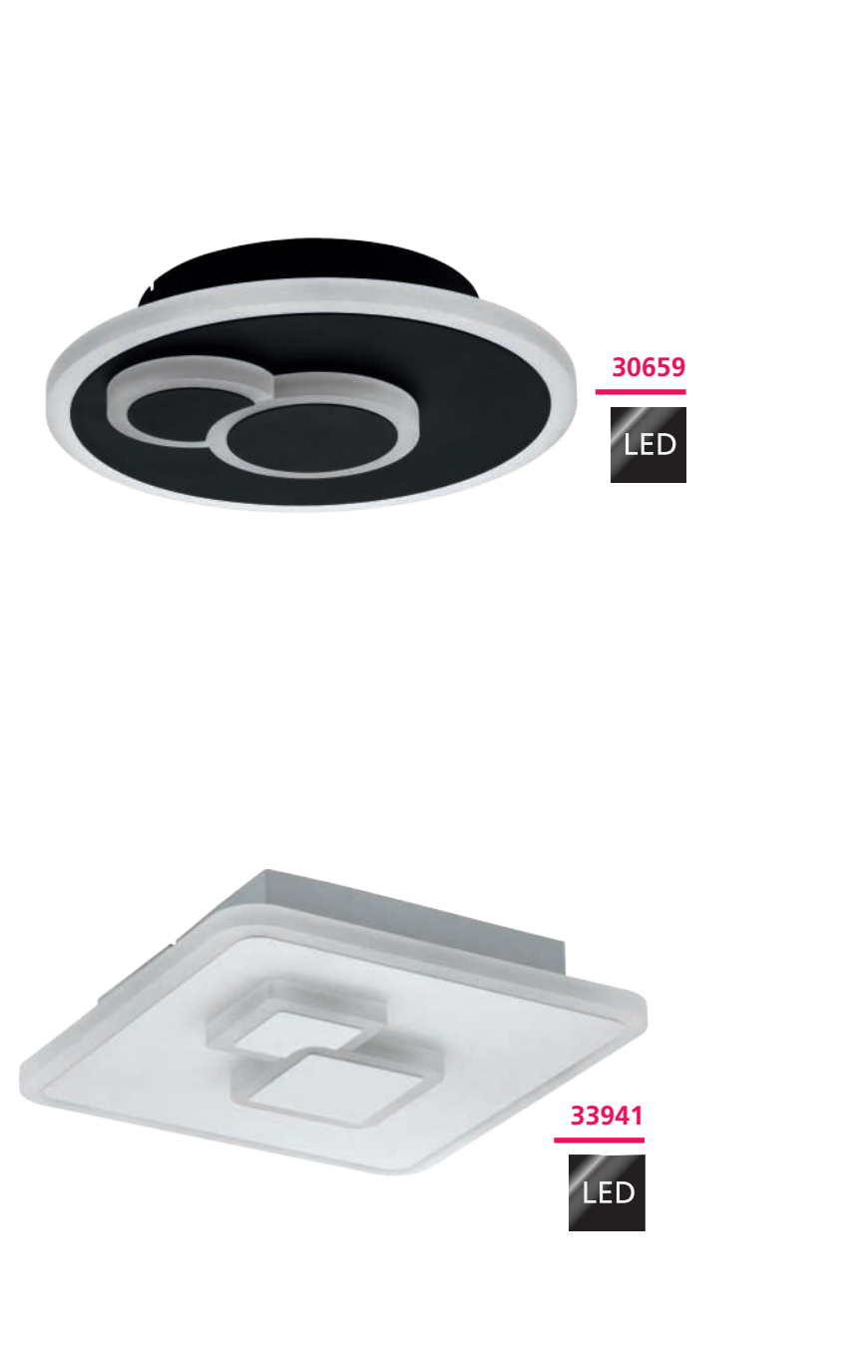

30659



33941



30658 CADEGAL

ceiling light; steel, black / plastic, white
Deckenleuchte; Stahl, schwarz / Kunststoff, weiss
plafonnier; acier, noir / plastique, blanc

L 200, B 200, H 50

LED

neutral
WHITE



7,8W

1200lm

30659 CADEGAL

ceiling light; steel, black / plastic, white
Deckenleuchte; Stahl, schwarz / Kunststoff, weiss
plafonnier; acier, noir / plastique, blanc

H 50, Ø 200

LED

neutral
WHITE



7,8W

1100lm

33941 CADEGAL

ceiling light; steel, white / plastic, white
Deckenleuchte; Stahl, weiss / Kunststoff, weiss
plafonnier; acier, blanc / plastique, blanc

L 200, B 200, H 50

LED

neutral
WHITE



7,8W

1200lm



9 002759 306588

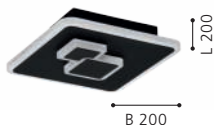

9 002759 306595

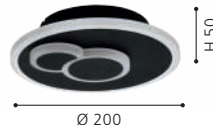

9 002759 339418

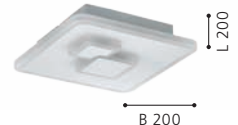

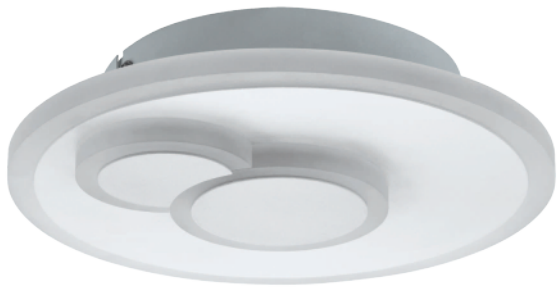

33942

LED



33964

LED



33942 CADEGAL

ceiling light; steel, white / plastic, white
Deckenleuchte; Stahl, weiss / Kunststoff, weiss
plafonnier; acier, blanc / plastique, blanc

H 50, Ø 200



7,8W 1100lm



33964 REMIDOS

ceiling light; steel, white / plastic, white
Deckenleuchte; Stahl, weiss / Kunststoff, weiss
plafonnier; acier, blanc / plastique, blanc

H 90, Ø 400

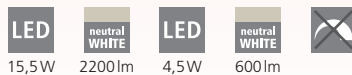

15,5W 2200lm 4,5W 600lm





98888



96037



96038



98888 METRASS

wall light; aluminium, black / plastic, satin finish
Wandleuchte; Alu, schwarz / Kunststoff, satiniert
Applique; aluminium, noir / plastique, satiné

L 200, H 105, A 60



1x 5,6W 680lm

96037 METRASS

wall light; aluminium, white / plastic, satin finish
Wandleuchte; Alu, weiss / Kunststoff, satiniert
Applique; aluminium, blanc / plastique, satiné

L 200, H 105, A 60



1x 5,6W 680lm

96038 METRASS

wall light; aluminium, satin nickel / plastic, satin finish
Wandleuchte; Alu, nickel-matt / Kunststoff, satiniert
Applique; aluminium, nickel mat / plastique, satiné

L 200, H 105, A 60



1x 5,6W 680lm



9 002759 988883



9 002759 960377

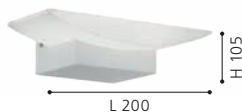

9 002759 960384

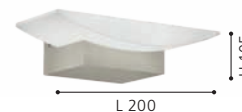



96042



96043



96042 METRASS 2

wall/ceiling light; aluminium, white / plastic, satin finish
Wand- / Deckenleuchte; Alu, weiss / Kunststoff, satiniert
Applique/Plafonnier; aluminium, blanc / plastique, satiné

L 170, H 200, A 55



2x 4,5W



960lm



9 002759 960421

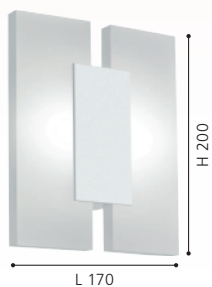

96043 METRASS 2

wall/ceiling light; aluminium, satin nickel / plastic, satin finish
Wand- / Deckenleuchte; Alu, nickel-matt / Kunststoff, satiniert
Applique/Plafonnier; aluminium, nickel mat / plastique, satiné

L 170, H 200, A 55



2x 4,5W



960lm



9 002759 960438





96039

LED



96041

LED

96039 METRASS 1

wall light; aluminium, white / plastic, satin finish
 Wandleuchte; Alu, weiss / Kunststoff, satiniert
 Applique; aluminium, blanc / plastique, satiné

L 130, H 130, A 50



1x 4,5W 480lm



9 002759 960391



96041 METRASS 1

wall light; aluminium, satin nickel / plastic, satin finish
 Wandleuchte; Alu, nickel-matt / Kunststoff, satiniert
 Applique; aluminium, nickel mat / plastique, satiné

L 130, H 130, A 50



1x 4,5W 480lm



9 002759 960414

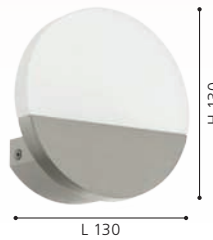



99606



99607



99609



99606 SARGINTO

wall/ceiling light; steel, white / plastic, white
Wand- / Deckenleuchte; Stahl, weiss / Kunststoff, weiss
Applique/Plafonnier; acier, blanc / plastique, blanc

L 590, B 140, H 45



6,3W 950lm 5,4W 570lm



9 002759 996062

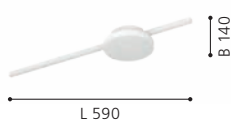

99607 SARGINTO

wall/ceiling light; steel, white / plastic, white
Wand- / Deckenleuchte; Stahl, weiss / Kunststoff, weiss
Applique/Plafonnier; acier, blanc / plastique, blanc

L 590, B 130, H 45



6,3W 950lm 5,4W 570lm



9 002759 996079

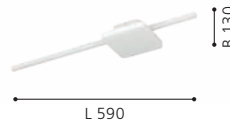

99609 SARGINTO

wall/ceiling light; steel, black / plastic, white
Wand- / Deckenleuchte; Stahl, schwarz / Kunststoff, weiss
Applique/Plafonnier; acier, noir / plastique, blanc

L 590, B 130, H 45



6,3W 950lm 5,4W 570lm



9 002759 996093

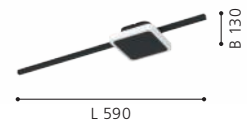



99608

LED



99608 SARGINTO

wall/ceiling light; steel, black / plastic, white

Wand- / Deckenleuchte; Stahl, schwarz / Kunststoff, weiss

Applique/Plafonnier; acier, noir / plastique, blanc

L 590, B 140, H 45

LED

6,3W

warm
WHITE

950lm

LED

5,4W

warm
WHITE

570lm



9 002759 996086

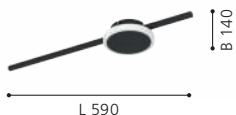



BATH & MIRROR LUMINAIRES

BAD- & SPIEGELLEUCHTEN
LUMINAIRES DE BAIN & MIROIR



EN PURE RELAXATION

Turn your bathroom into your personal wellness oasis. Trendy bathroom and mirror luminaires give a pleasant light and ensure relaxation and comfort.

DE ENTSPANNUNG PUR

Verwandeln Sie Ihr Badezimmer in eine persönliche Wohlfühloase. Trendige Bad- und Spiegelleuchten spenden ein angenehmes Licht und sorgen für Entspannung und Ihr Wohlbefinden.

FR DE LA PURE DÉTENTE











































Transformez votre salle de bains en un îlot personnel de bien-être. Des éclairages à la mode de miroirs et de bain confèrent une lumière agréable et vous assurent de la détente et du bien-être.





OVERVIEW

BATH & MIRROR LUMINAIRES
BAD- & SPIEGELLEUCHTEN
LUMINAIRES DE BAIN & MIROIR

 AMEZOLA 620	 SAN PERI 1 621	 TAMARA 1 622-623	 ALMONTE 624	 TOLIRICO 626	 PALMITAL 628-629	 MOSIANO 630	 BARI-M 630	
 FRANIA 631-632	 FRANIA-S 631, 633	 WASAO 1 632	 MANILVA 1 632	 PINETTO 634-635	 LED PALERMO 634-635	 LED CARPI 636-637	 FUEVA 5 638-646	
 ROMENDO 1 648-649	 SIDERNO 650	 SANIA 5 650-651	 PEGUERA 653	 VERDELLO 653-654	 GEMILIANA 654-655	 ALCUDIA 656	 CALNOVA 657	
 TORRETTA 657	 TRAGACETE 1 658-659	 GITA 2 660	 TABIANO 663	 CABUS 663	 VADUMI 664	 PANDELLA 2 666, 670	 PANDELLA 1 666-669	
 VINCHIO 670	 PALMERA 672	 ZOLA 672	 BARI 1 673	 STICKER 673	 BUENAVISTA 674	 BUENAVISTA 1 676	 BUENAVISTA 2 676-677	
 TABIANO-Z 44	 FUEVA-Z 76-87	 TOTARI-Z 88	<p>Bath & mirror lights can also be found in the EGLO connect.Z chapter.</p> <p>Bad- und Spiegelleuchten finden Sie auch im Kapitel EGLO connect.Z.</p> <p>Les luminaires de bain & miroir se trouvent également dans le chapitre EGLO connect.Z.</p>					



This product is available in different colors and shapes. / Dieser Artikel ist in unterschiedlichen Farben und Formen verfügbar. / Cet article est disponible en différentes couleurs et formes.

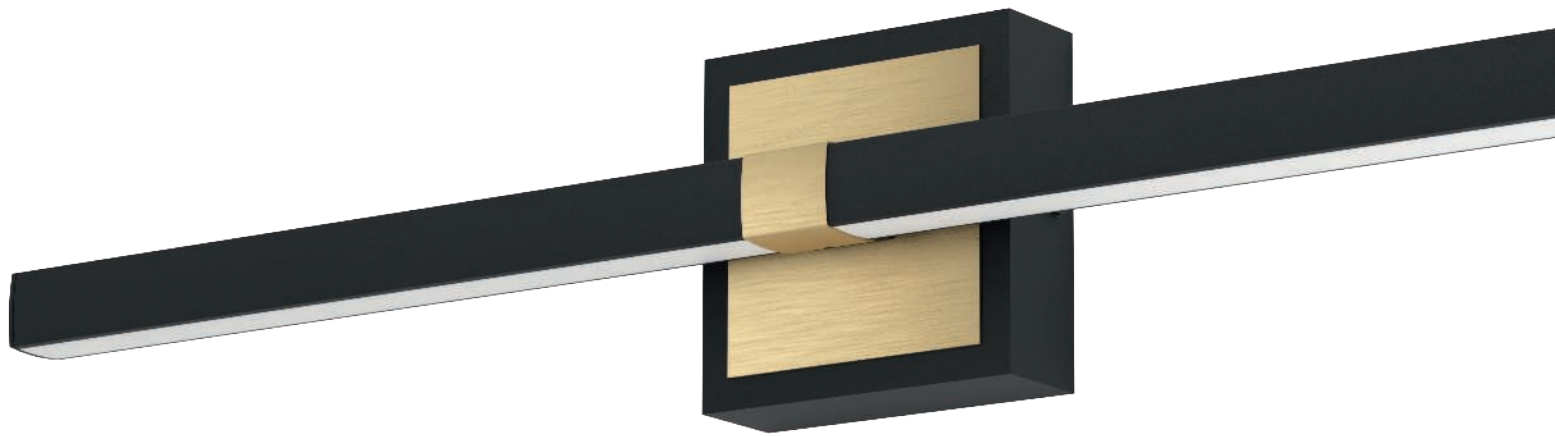



99123



IP44



AMEZOLA



99122



IP44

99122 AMEZOLA

wall/ceiling light; steel, black / glass, clear
Wand- / Deckenleuchte; Stahl, schwarz / Glas, klar
Applique/Plafonnier; acier, noir / verre, transparent

L 290, H 290, A 130



E27



2x 28W



IP44



9 002759 991222



L 290

99123 AMEZOLA

wall light; steel, black / glass, clear
Wandleuchte; Stahl, schwarz / Glas, klar
Applique; acier, noir / verre, transparent

L 110, H 260, A 100



E27



1x 40W



IP44



9 002759 991234



A 100

99124 AMEZOLA

wall light; steel, black / glass, clear
Wandleuchte; Stahl, schwarz / Glas, klar
Applique; acier, noir / verre, transparent

L 110, H 380, A 100



E27



2x 60W



IP44



9 002759 991241



A 100



99124



IP44



900428

LED



IP44

900428 SAN PERI 1

wall light; steel, black, white
Wandleuchte; Stahl, schwarz, weiss
Applique; acier, noir, blanc

L 130, H 180, A 160



GU10



1x 3W



warm
WHITE
1x
240lm



IP44



9 008606 243877





95994



IP44



95993



IP44

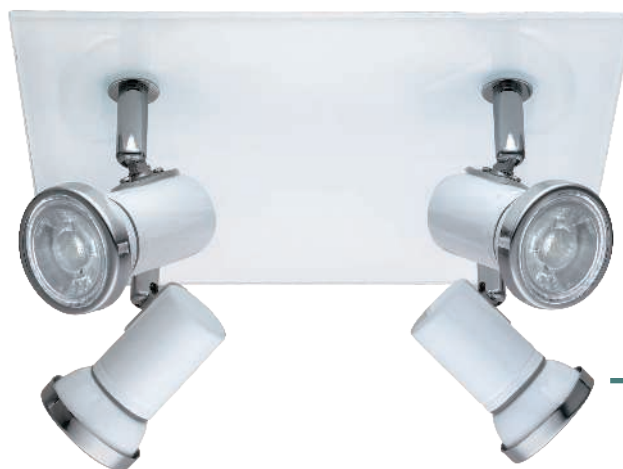

95995



IP44

95993 TAMARA 1

spot; steel, glass, white, chrome
Spot; Stahl, Glas, weiss, chrom
spot; acier, verre, blanc, chrome

L 120, B 120



GU10



1x 3W



warm
WHITE

1x
240lm



IP44



95994 TAMARA 1

spot; steel, glass, white, chrome
Spot; Stahl, Glas, weiss, chrom
spot; acier, verre, blanc, chrome

L 460, B 70



GU10



3x 3W



warm
WHITE

3x
240lm



IP44



95995 TAMARA 1

spot; steel, glass, white, chrome
Spot; Stahl, Glas, weiss, chrom
spot; acier, verre, blanc, chrome

L 240, B 260



GU10



4x 3W



warm
WHITE

4x
240lm



IP44



9 002759 959937



L 120



9 002759 959944



L 460



9 002759 959951



L 240



33677

LED



IP44



33678

LED



IP44

33677 TAMARA 1

spot; steel, black, chrome / glass, clear
 Spot; Stahl, schwarz, chrom / Glas, klar
 spot; acier, noir, chrome / verre, transparent

L 120, B 120



GU10



1x 3W



1x
warm
WHITE
240lm



IP44



33678 TAMARA 1

spot; steel, black, chrome / glass, clear
 Spot; Stahl, schwarz, chrom / Glas, klar
 spot; acier, noir, chrome / verre, transparent

L 240, B 260



GU10



4x 3W



4x
warm
WHITE
240lm



IP44



9 002759 336776



9 002759 336783

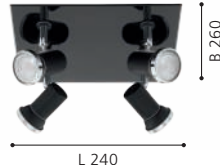

DESIGN
HIGHLIGHT
DETAIL



94879

LED



IP44



97699

LED



IP44

94879 ALMONTE

wall light; steel, chrome / brilliant glass, clear
Wandleuchte; Stahl, chrom / Brillantglas, klar
Applique; acier, chrome / verre brillant, transparent

L 110, H 230, A 170



97699 ALMONTE

ceiling light; steel, chrome / brilliant glass, clear
Deckenleuchte; Stahl, chrom / Brillantglas, klar
plafonnier; acier, chrome / verre brillant, transparent

H 300, Ø 500

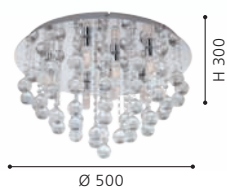
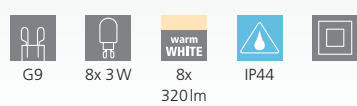

94878 ALMONTE

ceiling light; steel, chrome / brilliant glass, clear
Deckenleuchte; Stahl, chrom / Brillantglas, klar
plafonnier; acier, chrome / verre brillant, transparent

H 230, Ø 350

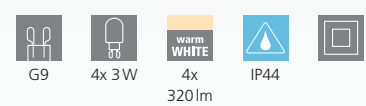



94878

LED



IP44





TOLORICO

These luminaires come with high quality brilliant glass.

Diese Leuchten sind mit hochwertigem Brillantglas ausgestattet.

Ces lumières sont fabriquées avec une haute qualité Equipé de verre brillant.



97054



IP44



97055



IP44

97054 TOLORICO

wall/ceiling light; stainless steel, chrome / plastic, brilliant glass, clear

Wand- / Deckenleuchte; Edelstahl, chrom / Kunststoff, Brillantglas, klar

Applique/Plafonnier; acier inoxydable, chrome / plastique, verre brillant, transparent
L 350, B 100, H 70



8W



1000lm



IP44



97055 TOLORICO

wall/ceiling light; stainless steel, chrome / plastic, brilliant glass, clear

Wand- / Deckenleuchte; Edelstahl, chrom / Kunststoff, Brillantglas, klar

Applique/Plafonnier; acier inoxydable, chrome / plastique, verre brillant, transparent
L 570, B 100, H 75



20,5W



2700lm



IP44



97056 TOLORICO

wall/ceiling light; stainless steel, chrome / plastic, brilliant glass, clear

Wand- / Deckenleuchte; Edelstahl, chrom / Kunststoff, Brillantglas, klar

Applique/Plafonnier; acier inoxydable, chrome / plastique, verre brillant, transparent
L 350, B 350, H 75



22W



3000lm



IP44



9 002759 970543



9 002759 970550



9 002759 970567





97056

LED



IP44





97965



IP44

97965 PALMITAL

wall/ceiling light; aluminium, steel, chrome / plastic, clear
Wand- / Deckenleuchte; Alu, Stahl, chrom / Kunststoff, klar
Applique/Plafonnier; aluminium, acier, chrome / plastique,
transparent

L 880, B 100, H 90



2x 11 W



2700lm



IP44



9 002759 979652

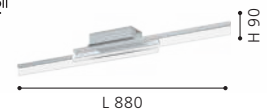



900844



IP44



97966



IP44



900845



IP44

900844 PALMITAL

wall/ceiling light; aluminium, steel, black / plastic, satin finish
Wand- / Deckenleuchte; Alu, Stahl, schwarz / Kunststoff, satiniert
Applique/Plafonnier; aluminium, acier, noir / plastique, satiné

L 880, B 100, H 90



2x 11 W 2700lm

97966 PALMITAL

wall light; aluminium, steel, chrome / plastic, clear
Wandleuchte; Alu, Stahl, chrom / Kunststoff, klar
Applique; aluminium, acier, chrome / plastique, transparent

L 595, H 80, A 65



1x 11 W 1350lm

900845 PALMITAL

wall light; aluminium, steel, black / plastic, satin finish
Wandleuchte; Alu, Stahl, schwarz / Kunststoff, satiniert
Applique; aluminium, acier, noir / plastique, satiné

L 595, H 80, A 65



1x 11 W 1350lm



9 008606 259762



L 880



9 002759 979669

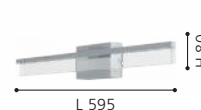

L 595



9 008606 259779

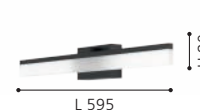

L 595



97531



IP44



94626



IP44



97531

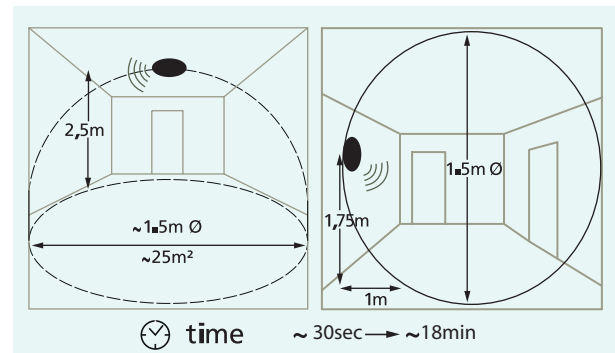

97531

These luminaires are equipped with an integrated motion sensor. The sensor is invisibly mounted behind the glass.

Diese Leuchten sind mit einem integrierten Bewegungssensor ausgestattet. Der Sensor ist unsichtbar hinter dem Glas befestigt.

Ces luminaires sont équipés d'un capteur de mouvement intégré. Le capteur est fixé de manière invisible derrière le verre.

94626 MOSIANO

wall/ceiling light; stainless steel, chrome / matte-opal glass, white

Wand- / Deckenleuchte; Edelstahl, chrom / Glas opal-matt, weiss

Applique/Plafonnier; acier inoxydable, chrome / verre opale mat, blanc

H 115, Ø 110



1x 3,3W



340 lm



IP44



97531 BARI-M

ceiling light; plastic, white / glass, white

Deckenleuchte; Kunststoff, weiss / Glas, weiss

plafonnier; plastique, blanc / verre, blanc

H 110, Ø 275



E27



1x 20W



IP44



9 002759 946265



9 002759 975319





97884



IP44



900363



IP44



900619



IP44



97884 FRANIA

wall/ceiling light; steel, white / plastic, white
Wand- / Deckenleuchte; Stahl, weiss / Kunststoff, weiss
Applique/Plafonnier; acier, blanc / plastique, blanc

H 70, Ø 330



14,6W 1600lm

900363 FRANIA-S

wall/ceiling light; steel, white / plastic with crystal effect, white
Wand- / Deckenleuchte; Stahl, weiss / Kunststoff m.Kristalleffekt, weiss
Applique/Plafonnier; acier, blanc / plastique avec effet cristal, blanc

H 55, Ø 310



18W 1850lm

900619 FRANIA-S

wall/ceiling light; steel, white / plastic with crystal effect, white
Wand- / Deckenleuchte; Stahl, weiss / Kunststoff m.Kristalleffekt, weiss
Applique/Plafonnier; acier, blanc / plastique avec effet cristal, blanc

H 55, Ø 310



15W 1800lm



9 002759 978846



9 008606 234455



9 008606 245161





94884



IP44



96229



IP44

94884 WASAO 1

wall/ceiling light; stainless steel, chrome / painted glass, white
Wand- / Deckenleuchte; Edelstahl, chrom / Glas lackiert, weiss
Applique/Plafonnier; acier inoxydable, chrome / verre laqué, blanc

L 320, B 320, H 60



4x 5,4W 2040lm

96229 MANILVA 1

wall light; steel, chrome / plastic, white
Wandleuchte; Stahl, chrom / Kunststoff, weiss
Applique; acier, chrome / plastique, blanc

L 290, B 290, H 70



2x 5,4W 1100lm 2x 2,6W 660lm



IP44

97885 FRANIA

wall/ceiling light; steel, white / plastic, white
Wand- / Deckenleuchte; Stahl, weiss / Kunststoff, weiss
Applique/Plafonnier; acier, blanc / plastique, blanc

L 330, B 330, H 70



14,6W 1600lm



9 002759 948849

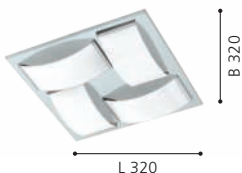

L 320



9 002759 962296



L 290



9 002759 978853



L 330



97885



IP44



900364



IP44

900364 FRANIA-S

wall/ceiling light; steel, white / plastic with crystal effect, white
Wand- / Deckenleuchte; Stahl, weiss / Kunststoff m.Kristalleffekt, weiss

Applique/Plafonnier; acier, blanc / plastique avec effet cristal, blanc

L 330, B 330, H 70



14,6W

1600lm



9 008606 234462



L 330

B 330



900846



IP44



900366



IP44

900366 PINETTO

wall/ceiling light; steel, white / plastic, white, black
Wand- / Deckenleuchte; Stahl, weiss / Kunststoff, weiss, schwarz
Applique/Plafonnier; acier, blanc / plastique, blanc, noir

H 65, Ø 340



15,6W



1900lm



IP44

900846 LED PALERMO

wall/ceiling light; steel, black / satin glass, white painted
Wand- / Deckenleuchte; Stahl, schwarz / Glas satiniert, weiss lackiert
Applique/Plafonnier; acier, noir / verre satiné, blanc laqué

H 75, Ø 300



3x 5,7W



2100lm



IP44

DESIGN
HIGHLIGHT
DETAIL



9 008606 235971



9 008606 259786





94999



IP44



900365



IP44



94998



IP44

900365 PINETTO

wall/ceiling light; steel, white / plastic, white, chrome
Wand- / Deckenleuchte; Stahl, weiss / Kunststoff, weiss, chrom
Applique/Plafonnier; acier, blanc / plastique, blanc, chrome

H 65, Ø 340



15,6W 1900lm

94998 LED PALERMO

wall/ceiling light; steel, chrome / satin glass, white painted
Wand- / Deckenleuchte; Stahl, chrom / Glas satiniert, weiss lackiert
Applique/Plafonnier; acier, chrome / verre satiné, blanc laqué

H 60, Ø 225



3x 3,6W 1110lm

94999 LED PALERMO

wall/ceiling light; steel, chrome / satin glass, white painted
Wand- / Deckenleuchte; Stahl, chrom / Glas satiniert, weiss lackiert
Applique/Plafonnier; acier, chrome / verre satiné, blanc laqué

H 75, Ø 300



3x 5,7W 2100lm



9 008606 235964

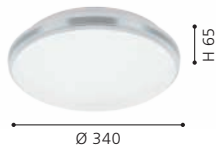

9 002759 949983

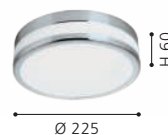

9 002759 949990





33682



IP44



95282



IP44



900369



IP44

33682 LED CARPI

wall/ceiling light; steel, black, white / plastic, white
Wand- / Deckenleuchte; Stahl, schwarz, weiss / Kunststoff, weiss
Applique/Plafonnier; acier, noir, blanc / plastique, blanc

Ø 300, A 75



3x 3,6W



960lm



IP44

900369 LED CARPI

ceiling light; steel, brushed brass, white / plastic, white
Deckenleuchte; Stahl, messing-gebürstet, weiss / Kunststoff, weiss
plafonnier; acier, laiton brossé, blanc / plastique, blanc

Ø 300, A 75



3x 3,6W



1110lm



IP44

95282 LED CARPI

wall/ceiling light; steel, white, chrome / plastic, white
Wand- / Deckenleuchte; Stahl, weiss, chrom / Kunststoff, weiss
Applique/Plafonnier; acier, blanc, chrome / plastique, blanc

Ø 300, A 75



3x 3,6W



960lm



IP44



9 002759 336820



Ø 300



9 008606 240623



Ø 300



9 002759 952822



Ø 300



95283



IP44



95283 LED CARPI

wall/ceiling light; steel, white, chrome / plastic, white
Wand- / Deckenleuchte; Stahl, weiss, chrom / Kunststoff, weiss
Applique/Plafonnier; acier, blanc, chrome / plastique, blanc

Ø 385, A 75







3x 7,3W 2220lm IP44

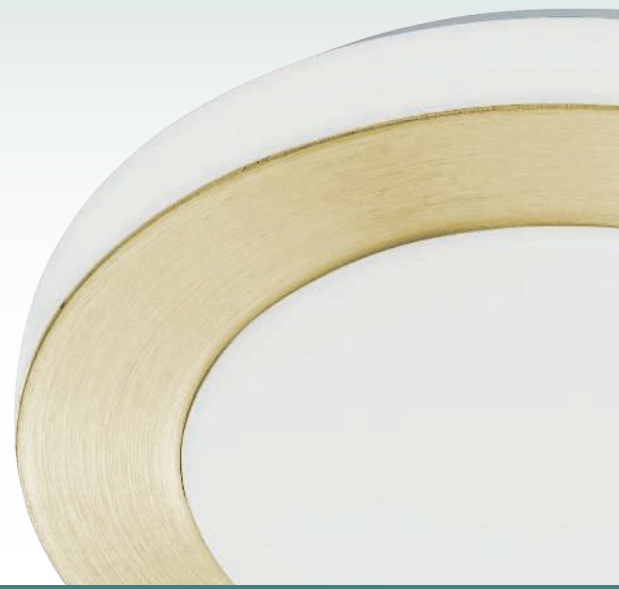

9 002759 952839



Ø 385

FUEVA 5

These luminaires are protected against splash water.

Diese Leuchten sind gegen Spritzwasser geschützt.

Les luminaires sont protégées contre les éclaboussures d'eau.



	0	1	2	3
EU	X	X	✓	✓
FR	X	X	X	✓



99202



IP44

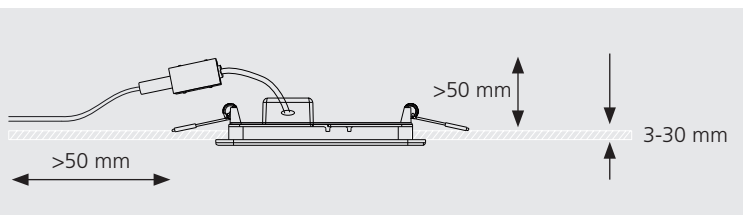

FUEVA 5

Slim design and minimal installation depth. This makes it ideal for ceiling constructions with little space. Easy installation / replacement of the lights with practical connectors.

Schlanke Bauform und minimale Einbautiefe. Dadurch ideal für Deckenkonstruktionen mit wenig Platz. Einfache Montage / Austausch der Leuchten durch praktischen Verbinder.

Conception mince et profondeur d'installation minimale. Cela le rend idéal pour les constructions de plafond avec peu d'espace. Installation / remplacement facile des lumières avec des connecteurs pratiques.

99202 FUEVA 5

recessed light; steel, white / plastic, white
Einbauleuchte; Stahl, weiss / Kunststoff, weiss
luminaire encastrable; acier, blanc / plastique, blanc

Ø 86, ET 26



Ø 86

99203 FUEVA 5

recessed light; steel, white / plastic, white
Einbauleuchte; Stahl, weiss / Kunststoff, weiss
luminaire encastrable; acier, blanc / plastique, blanc

Ø 166, ET 26



Ø 166

99206 FUEVA 5

recessed light; steel, white / plastic, white
Einbauleuchte; Stahl, weiss / Kunststoff, weiss
luminaire encastrable; acier, blanc / plastique, blanc

Ø 86, ET 26



Ø 86



99203

LED



IP44



99206

LED



IP44



99207

LED



IP44

99207 FUEVA 5

recessed light; steel, white / plastic, white
Einbauleuchte; Stahl, weiss / Kunststoff, weiss
luminaire encastrable; acier, blanc / plastique, blanc

Ø 166, ET 26

LED

11W

neutral
WHITE

1350lm



Ø 155



IP44



9 002759 992071



Ø 166

FUEVA 5

These luminaires are protected against splash water.

Diese Leuchten sind gegen Spritzwasser geschützt.

Les luminaires sont protégées contre les éclaboussures d'eau.



IP44

	0	1	2	3
EU	X	X	✓	✓
FR	X	X	X	✓



99208



IP44



99209



IP44

FUEVA 5

Slim design and minimal installation depth. This makes it ideal for ceiling constructions with little space. Easy installation / replacement of the lights with practical connectors.

Schlanke Bauform und minimale Einbautiefe. Dadurch ideal für Deckenkonstruktionen mit wenig Platz. Einfache Montage / Austausch der Leuchten durch praktischen Verbinder.

Conception mince et profondeur d'installation minimale. Cela rend idéal pour les constructions de plafond avec peu d'espace. Installation / remplacement facile des lumières avec des connecteurs pratiques.

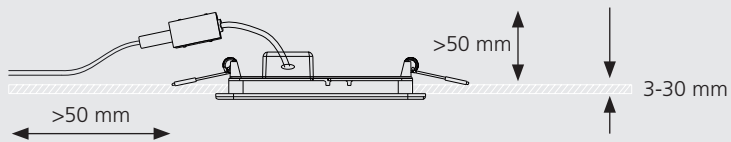

99208 FUEVA 5

recessed light; steel, chrome / plastic, white
Einbauleuchte; Stahl, chrom / Kunststoff, weiss
luminaire encastrable; acier, chrome / plastique, blanc

Ø 86, ET 26



2,7W



330lm



Ø 75



IP44



9 002759 992088



Ø 86

99209 FUEVA 5

recessed light; steel, chrome / plastic, white
Einbauleuchte; Stahl, chrom / Kunststoff, weiss
luminaire encastrable; acier, chrome / plastique, blanc

Ø 166, ET 26



11W



1350lm



Ø 155



IP44



9 002759 992095



Ø 166

99205 FUEVA 5

recessed light; steel, chrome / plastic, white
Einbauleuchte; Stahl, chrom / Kunststoff, weiss
luminaire encastrable; acier, chrome / plastique, blanc

Ø 166, ET 26



11W



1350lm



Ø 155



IP44



9 002759 992057



Ø 166



99205



IP44



99204



IP44

99204 FUEVA 5

recessed light; steel, chrome / plastic, white
Einbauleuchte; Stahl, chrom / Kunststoff, weiss
luminaire encastrable; acier, chrome / plastique, blanc

Ø 86, ET 26



2,7W



330lm



Ø 75



IP44



9 002759 992040



Ø 86

FUEVA 5

These luminaires are protected against splash water.

Diese Leuchten sind gegen Spritzwasser geschützt.

Les luminaires sont protégées contre les éclaboussures d'eau.



IP44

	0	1	2	3
EU	X	X	✓	✓
FR	X	X	X	✓



99213



IP44



99214



IP44

FUEVA 5

Slim design and minimal installation depth. This makes it ideal for ceiling constructions with little space. Easy installation / replacement of the lights with practical connectors.

Schlanke Bauform und minimale Einbautiefe. Dadurch ideal für Deckenkonstruktionen mit wenig Platz. Einfache Montage / Austausch der Leuchten durch praktischen Verbinder.

Conception mince et profondeur d'installation minimale. Cela le rend idéal pour les constructions de plafond avec peu d'espace. Installation / remplacement facile des lumières avec des connecteurs pratiques.

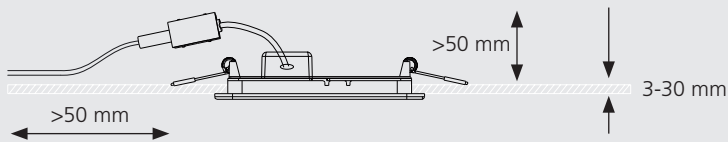

99213 FUEVA 5

recessed light; steel, black / plastic, white
Einbauleuchte; Stahl, schwarz / Kunststoff, weiss
luminaire encastrable; acier, noir / plastique, blanc

Ø 86, ET 26



2,7W

330lm

Ø 75

IP44



9 002759 992132



Ø 86

99214 FUEVA 5

recessed light; steel, black / plastic, white
Einbauleuchte; Stahl, schwarz / Kunststoff, weiss
luminaire encastrable; acier, noir / plastique, blanc

Ø 166, ET 26



11W

1350lm

Ø 155

IP44



9 002759 992149



Ø 166

99212 FUEVA 5

recessed light; steel, black / plastic, white
Einbauleuchte; Stahl, schwarz / Kunststoff, weiss
luminaire encastrable; acier, noir / plastique, blanc

Ø 166, ET 26



11W

1350lm

Ø 155

IP44



9 002759 992125



Ø 166



99212

LED



IP44



99211

LED



IP44

99211 FUEVA 5

recessed light; steel, black / plastic, white
Einbauleuchte; Stahl, schwarz / Kunststoff, weiss
luminaire encastrable; acier, noir / plastique, blanc

Ø 86, ET 26

LED

2,7W

warm
WHITE

330lm



Ø 75



IP44



9 002759 992118



Ø 86



99265



IP44



99267



IP44

99265 FUEVA 5

surface-mounted light; steel, white / plastic, white
 Aufbauleuchte; Stahl, weiss / Kunststoff, weiss
 luminaire en saillie; acier, blanc / plastique, blanc

H 28, Ø 285



20,5W 2400lm

99267 FUEVA 5

surface-mounted light; steel, black / plastic, white
 Aufbauleuchte; Stahl, schwarz / Kunststoff, weiss
 luminaire en saillie; acier, noir / plastique, blanc

H 28, Ø 285



20,5W 2400lm

99266 FUEVA 5

surface-mounted light; steel, chrome / plastic, white
 Aufbauleuchte; Stahl, chrom / Kunststoff, weiss
 luminaire en saillie; acier, chrome / plastique, blanc

H 28, Ø 285



20,5W 2400lm



9 002759 992651



9 002759 992675



9 002759 992668





99266

LED



IP44



99268



IP44



99271



IP44

99268 FUEVA 5

surface-mounted light; steel, white / plastic, white
 Aufbauleuchte; Stahl, weiss / Kunststoff, weiss
 luminaire en saillie; acier, blanc / plastique, blanc

L 285, B 285, H 30



20,5W 2400lm

99271 FUEVA 5

surface-mounted light; steel, black / plastic, white
 Aufbauleuchte; Stahl, schwarz / Kunststoff, weiss
 luminaire en saillie; acier, noir / plastique, blanc

L 285, B 285, H 30



20,5W 2400lm

99269 FUEVA 5

surface-mounted light; steel, chrome / plastic, white
 Aufbauleuchte; Stahl, chrom / Kunststoff, weiss
 luminaire en saillie; acier, chrome / plastique, blanc

L 285, B 285, H 30



20,5W 2400lm



9 002759 992682

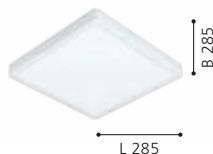

9 002759 992712



9 002759 992699

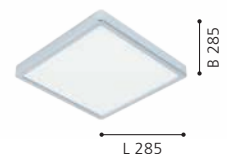



99269

LED



IP44





96541



IP44



96542



IP44



96544



IP44

96541 ROMENDO 1

wall light; steel, chrome / plastic, clear, satin finish
Wandleuchte; Stahl, chrom / Kunststoff, klar, satiniert
Applique; acier, chrome / plastique, transparent, satiné

L 70, H 155, A 120



2x 7,2W 1080lm

IP44

96542 ROMENDO 1

wall light; steel, chrome / plastic, clear, satin finish
Wandleuchte; Stahl, chrom / Kunststoff, klar, satiniert
Applique; acier, chrome / plastique, transparent, satiné

L 300, H 70, A 125



2x 7,2W 1080lm

IP44

96544 ROMENDO 1

ceiling light; steel, chrome / plastic, clear, satin finish
Deckenleuchte; Stahl, chrom / Kunststoff, klar, satiniert
plafonnier; acier, chrome / plastique, transparent, satiné

L 320, B 320, H 70



5x 5,4W 3750lm

IP44



9 002759 965419

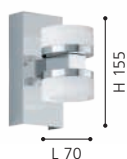

9 002759 965426

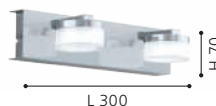

9 002759 965440

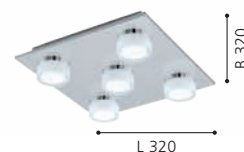



ROMENDO 1

These luminaires are dimmable.

Diese Leuchten sind dimmbar.

Ces luminaires sont graduables.

96543 ROMENDO 1

wall light; steel, chrome / plastic, clear, satin finish
Wandleuchte; Stahl, chrom / Kunststoff, klar, satiniert
Applique; acier, chrome / plastique, transparent, satiné

L 450, H 70, A 125

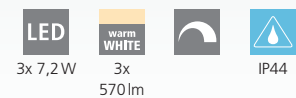

96543

LED



IP44



97718



IP44



97719



IP44



99692



IP44

97718 SIDERNO

mirror light; steel, chrome / plastic, satin finish
Spiegelleuchte; Stahl, chrom / Kunststoff, satiniert
applique pour miroir; acier, chrome / plastique, satiné

L 350, B 60, A 55



8,3W



1000lm



IP44



97719 SIDERNO

mirror light; steel, chrome / plastic, satin finish
Spiegelleuchte; Stahl, chrom / Kunststoff, satiniert
applique pour miroir; acier, chrome / plastique, satiné

L 580, B 60, A 65



16W



1600lm



IP44



99692 SANIA 5

wall light; steel, satin nickel, white / plastic, satin finish
Wandleuchte; Stahl, nickel-matt, weiss / Kunststoff, satiniert
Applique; acier, nickel mat, blanc / plastique, satiné

L 620, H 80, A 90



26,5W



3200lm



IP44



9 002759 977184

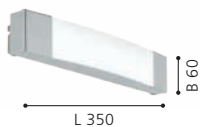

9 002759 977191

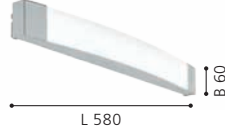

9 002759 996925

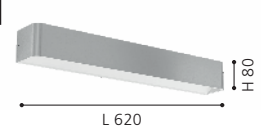



99691

LED



IP44

99691 SANIA 5

wall light; steel, black, white / plastic, satin finish

Wandleuchte; Stahl, schwarz, weiss / Kunststoff, satiniert

Applique; acier, noir, blanc / plastique, satiné

L 620, H 80, A 90

LED

26,5W

warm
WHITE

3200lm



IP44



9 002759 996918





900929

LED



IP44



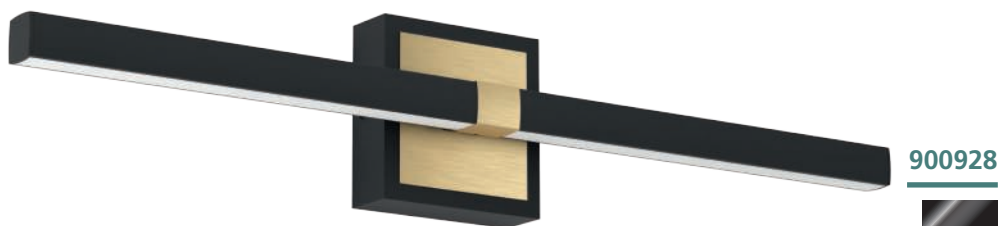

900928



IP44



900475



IP44

900929 PEGUERA

wall light; aluminium, steel, black, brushed brass / plastic, white
Wandleuchte; Alu, Stahl, schwarz, messing-gebürstet / Kunststoff, weiss
Applique; aluminium, acier, noir, laiton brossé / plastique, blanc

L 800, H 110, A 70



17,5W 2000lm

900928 PEGUERA

wall light; aluminium, steel, black, brushed brass / plastic, white
Wandleuchte; Alu, Stahl, schwarz, messing-gebürstet / Kunststoff, weiss
Applique; aluminium, acier, noir, laiton brossé / plastique, blanc

L 600, H 110, A 70



1x 11 W 1165lm

900475 VERDELLO

mirror light; plastic, black, brass / plastic, white
Spiegelleuchte; Kunststoff, schwarz, messing / Kunststoff, weiss
applique pour miroir; plastique, noir, laiton / plastique, blanc

L 600, B 60, H 105



5W 750lm



9 008606 274994

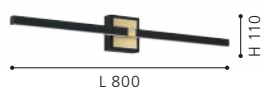

9 008606 274987

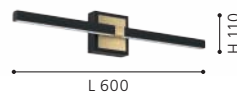

9 008606 244126

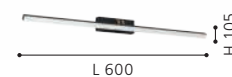

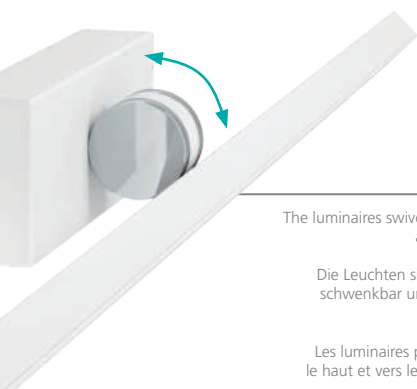

VERDELLO

The luminaires swivel up and down and have a CCT switch on the side.

Die Leuchten sind nach oben und unten schwenkbar und haben einen seitlichen CCT-Schalter.

Les luminaires peuvent être orientés vers le haut et vers le bas et sont équipés d'un interrupteur CCT latéral.



900476



IP44

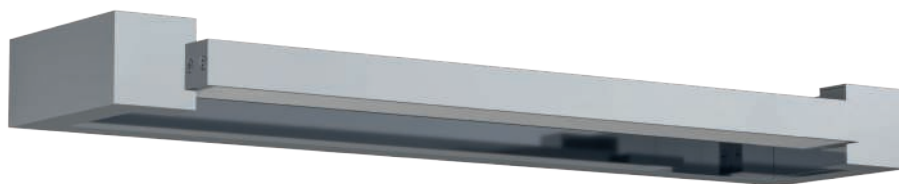

900616



IP44

900476 VERDELLO

mirror light; plastic, white, chrome / plastic, white
Spiegelleuchte; Kunststoff, weiss, chrom / Kunststoff, weiss
applique pour miroir; plastique, blanc, chrome / plastique, blanc

L 600, B 60, H 105



5W



750lm



IP44



9 008606 244133



900616 GEMILIANA

mirror light; steel, chrome / plastic, white
Spiegelleuchte; Stahl, chrom / Kunststoff, weiss
applique pour miroir; acier, chrome / plastique, blanc

L 450, H 40, A 100



8,9W



1000lm



IP44



9 008606 245130



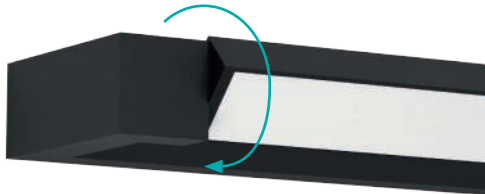

GEMILIANA

The LED profiles of these luminaires can be swivelled for direct or indirect light.

Die LED-Profilе dieser Leuchten sind schwenkbar für direktes oder indirektes Licht.

Les profilés LED de ces luminaires sont orientables pour un éclairage direct ou indirect.

900615 GEMILIANA

mirror light; steel, black / plastic, white
Spiegelleuchte; Stahl, schwarz / Kunststoff, weiss
applique pour miroir; acier, noir / plastique, blanc

L 450, H 40, A 100



8,9W

1000lm

IP44



9 008606 245123



900615

LED



IP44





900618

LED



IP44



900617

LED



IP44

900618 ALCUDIA

mirror light; aluminium, steel, chrome / plastic, satin finish
Spiegelleuchte; Alu, Stahl, chrom / Kunststoff, satiniert
applique pour miroir; aluminium, acier, chrome / plastique, satiné

L 420, H 30, A 60

LED

2x 5,5W

warm
WHITE

1200lm



IP44



900617 ALCUDIA

mirror light; aluminium, steel, black / plastic, satin finish
Spiegelleuchte; Alu, Stahl, schwarz / Kunststoff, satiniert
applique pour miroir; aluminium, acier, noir / plastique, satiné

L 420, H 30, A 60

LED

2x 5,5W

warm
WHITE

1200lm



IP44



9 008606 245154



9 008606 245147



COLOUR RENDERING INDEX FARBWIEDERGABE-INDEX L'INDICE DE RESTITUTION DE COULEURS

The colour rendering index Ra describes the colour rendering quality of lamps. The higher the Ra value, the less will the artificial light change the colour of an object. The maximum Ra value (e.g. the Ra value of the sun) is 100. Therefore, lamps with an Ra above 90 will make you look more natural.

CRI >90 This button indicates Lamps that have an Ra value of >90.

Mit dem Farbwiedergabe-Index Ra wird die Qualität der Farbwiedergabe von Leuchten beschrieben. Je höher der Ra-Wert ist, desto weniger verfälscht das künstliche Licht die Farbe von Objekten. Der maximale Ra-Wert (z.B. der Ra-Wert der Sonne) ist 100. Leuchten mit Ra >90 lassen Sie somit natürlicher aussehen.

CRI >90 Dieser Button kennzeichnet Leuchten die einen Ra-Wert von >90 haben.

L'indice de restitution de couleurs Ra décrit la qualité de restitution des éclairages. Plus la valeur Ra est élevée, moins la lumière artificielle falsifie la couleur des objets. La valeur Ra maximale (par ex. la valeur Ra du soleil) est 100.

CRI >90 Ce bouton signale les luminaires qui ont une valeur Ra >90.

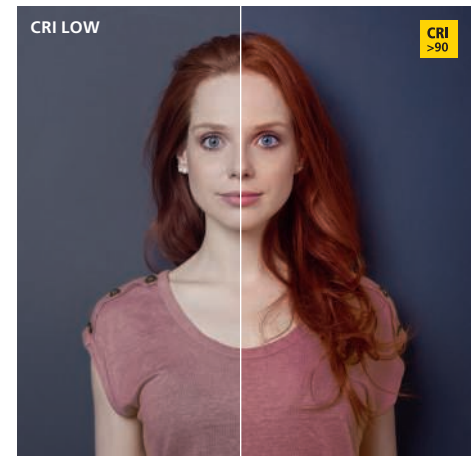

94716 CALNOVA

wall light; steel, satin nickel / satin glass, white
Wandleuchte; Stahl, nickel-matt / Glas satiniert, weiss
Applique; acier, nickel mat / verre satiné, blanc

L 600, B 50, A 85



CRI >90



94617 TORRETTA

mirror light; steel, satin nickel / plastic, white
Spiegelleuchte; Stahl, nickel-matt / Kunststoff, weiss
applique pour miroir; acier, nickel mat / plastique, blanc

L 600, B 40, A 75



CRI >90



TRAGACETE 1

These luminaires refer to an on / off button directly on the luminaire.

Diese Leuchten verfügen über einen Ein-/Ausschaltknopf direkt an der Leuchte.

Ces luminaires se réfèrent à un bouton marche / arrêt directement sur le luminaire.



99776



IP44



99777



IP44



99778



IP44

99776 TRAGACETE 1

mirror light; plastic, steel, silver, chrome / plastic, white
Spiegelleuchte; Kunststoff, Stahl, silber, chrom / Kunststoff, weiss

applique pour miroir; plastique, acier, argent, chrome / plastique, blanc

L 450, B 45, H 45



7,5W



900lm



IP44



9 002759 997762



B 45

99777 TRAGACETE 1

mirror light; plastic, steel, silver, chrome / plastic, white
Spiegelleuchte; Kunststoff, Stahl, silber, chrom / Kunststoff, weiss

applique pour miroir; plastique, acier, argent, chrome / plastique, blanc

L 600, B 45, H 45



15,5W



1900lm



IP44



9 002759 997779



B 45

99778 TRAGACETE 1

mirror light; plastic, steel, silver, chrome / plastic, white
Spiegelleuchte; Kunststoff, Stahl, silber, chrom / Kunststoff, weiss

applique pour miroir; plastique, acier, argent, chrome / plastique, blanc

L 770, B 45, H 45



18,5W



2600lm



IP44



9 002759 997786



B 45



99339

LED



IP44

99339 TRAGACETE 1

mirror light; aluminium, silver, chrome / plastic, white
 Spiegelleuchte; Alu, silber, chrom / Kunststoff, weiss
 applique pour miroir; aluminium, argent, chrome / plastique, blanc

L 680, B 55, H 70

LED

15W

neutral
WHITE

1850lm



IP44

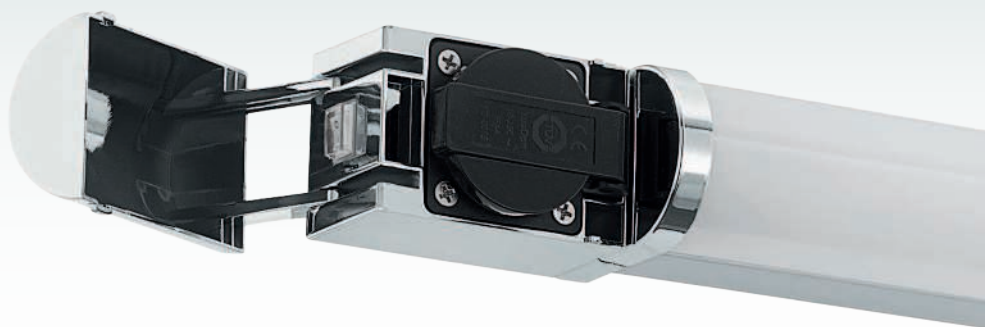

99339

These luminaires have a built-in socket.

Diese Leuchten verfügen über eine eingebaute Steckdose.

Ces luminaires disposent d'une prise de courant intégrée.



9 002759 993399

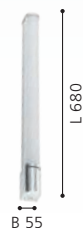



DESIGN
HIGHLIGHT
DETAIL



94712



IP44



94713



IP44

94712 GITA 2

wall/ceiling light; cast metal, chrome / plastic, white
Wand- / Deckenleuchte; Metallguss, chrom / Kunststoff, weiss
Applique/Plafonnier; fonte métallique, chrome / plastique, blanc

L 350, B 75, H 75



8,3W 1000lm



9 002759 947125



94713 GITA 2

wall/ceiling light; cast metal, chrome / plastic, white
Wand- / Deckenleuchte; Metallguss, chrom / Kunststoff, weiss
Applique/Plafonnier; fonte métallique, chrome / plastique, blanc

L 600, B 75, H 75



16W 1900lm



9 002759 947132

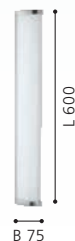

94714 GITA 2

wall/ceiling light; cast metal, chrome / plastic, white
Wand- / Deckenleuchte; Metallguss, chrom / Kunststoff, weiss
Applique/Plafonnier; fonte métallique, chrome / plastique, blanc

L 900, B 75, H 75



8,3W 850lm 16W 1600lm



9 002759 947149





94714

LED



IP44



94613

LED





94612



96937



IP44

94613 TABIANO

mirror light; steel, chrome / plastic, white
Spiegelleuchte; Stahl, chrom / Kunststoff, weiss
applique pour miroir; acier, chrome / plastique, blanc

L 605, H 70, A 130



3x 3,2W 900lm

94612 TABIANO

mirror light; steel, chrome / plastic, white
Spiegelleuchte; Stahl, chrom / Kunststoff, weiss
applique pour miroir; acier, chrome / plastique, blanc

L 405, H 70, A 130



2x 3,2W 600lm

96937 CABUS

wall light; steel, chrome / plastic, satin finish
Wandleuchte; Stahl, chrom / Kunststoff, satiniert
Applique; acier, chrome / plastique, satiné

L 450, H 45, A 115



3x 4,5W 1350lm



9 002759 946135

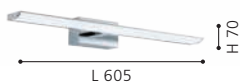

9 002759 946128

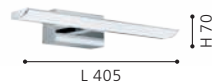

9 002759 969370

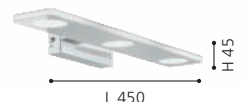

DESIGN
HIGHLIGHT
DETAIL



97081



IP44



97082



IP44

97081 VADUMI

wall light; plastic, chrome / plastic, white
Wandleuchte; Kunststoff, chrom / Kunststoff, weiss
Applique; plastique, chrome / plastique, blanc

L 400, H 50, A 125



7,4W



900lm



IP44



97082 VADUMI

wall light; plastic, chrome / plastic, white
Wandleuchte; Kunststoff, chrom / Kunststoff, weiss
Applique; plastique, chrome / plastique, blanc

L 600, H 50, A 125



11W



1350lm



IP44



97083 VADUMI

wall light; plastic, chrome / plastic, white
Wandleuchte; Kunststoff, chrom / Kunststoff, weiss
Applique; plastique, chrome / plastique, blanc

L 780, H 50, A 125



14W



1700lm



IP44



9 002759 970819



9 002759 970826

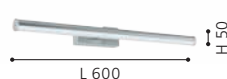

9 002759 970833

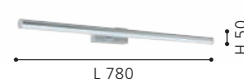



97083

LED



IP44





99731



IP44



98908



IP44



98677



IP44

99731 PANDELLA 2

mirror light; aluminium, plastic, black / plastic, white
Spiegelleuchte; Alu, Kunststoff, schwarz / Kunststoff, weiss
applique pour miroir; aluminium, plastique, noir / plastique, blanc

L 600, H 40, A 120



11W



1400lm



IP44



98908 PANDELLA 1

mirror light; aluminium, plastic, black / plastic, white
Spiegelleuchte; Alu, Kunststoff, schwarz / Kunststoff, weiss
applique pour miroir; aluminium, plastique, noir / plastique, blanc

L 600, H 40, A 120



11W



1350lm



IP44



98677 PANDELLA 1

mirror light; aluminium, plastic, black / plastic, white
Spiegelleuchte; Alu, Kunststoff, schwarz / Kunststoff, weiss
applique pour miroir; aluminium, plastique, noir / plastique, blanc

L 780, H 40, A 120



14W



1700lm



IP44



9 002759 997311



9 002759 989088



9 002759 986773



DESIGN
HIGHLIGHT
DETAIL



98907

LED



IP44

98907 PANDELLA 1

mirror light; aluminium, plastic, black / plastic, white
Spiegelleuchte; Alu, Kunststoff, schwarz / Kunststoff, weiss
applique pour miroir; aluminium, plastique, noir / plastique,
blanc

L 400, H 40, A 120

LED

7,4W

neutral
WHITE

900lm



IP44



9 002759 989071





96064



IP44



96065



IP44



96066



IP44

96064 PANDELLA 1

mirror light; aluminium, plastic, chrome, silver / plastic, white
Spiegelleuchte; Alu, Kunststoff, chrom, silber / Kunststoff, weiss
applique pour miroir; aluminium, plastique, chrome, argent /
plastique, blanc

L 400, H 40, A 120



7,4W



900lm



IP44



96065 PANDELLA 1

mirror light; aluminium, plastic, chrome, silver / plastic, white
Spiegelleuchte; Alu, Kunststoff, chrom, silber / Kunststoff, weiss
applique pour miroir; aluminium, plastique, chrome, argent /
plastique, blanc

L 600, H 40, A 120



11W



1350lm



IP44



96066 PANDELLA 1

mirror light; aluminium, plastic, chrome, silver / plastic, white
Spiegelleuchte; Alu, Kunststoff, chrom, silber / Kunststoff, weiss
applique pour miroir; aluminium, plastique, chrome, argent /
plastique, blanc

L 780, H 40, A 120



14W



1700lm



IP44



9 002759 960643



9 002759 960650

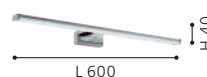

9 002759 960667





99297



IP44

99297 PANELLA 1

mirror light; aluminium, plastic, chrome, silver / plastic, white
 Spiegelleuchte; Alu, Kunststoff, chrom, silber / Kunststoff, weiss
 applique pour miroir; aluminium, plastique, chrome, argent /
 plastique, blanc

L 1200, H 40, A 120

13,5W	1750lm		IP44	

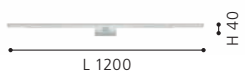



97059



IP44

97059

These luminaires are equipped with an integrated motion sensor. The sensor is invisibly mounted behind the housing.

Diese Leuchten sind mit einem integrierten Bewegungssensor ausgestattet. Der Sensor ist unsichtbar hinter dem Gehäuse befestigt.

Ces luminaires sont équipés d'un capteur de mouvement intégré. Le capteur est fixé de manière invisible derrière le boîtier.

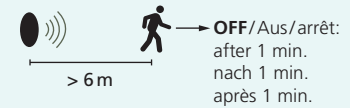
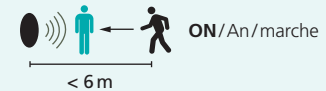
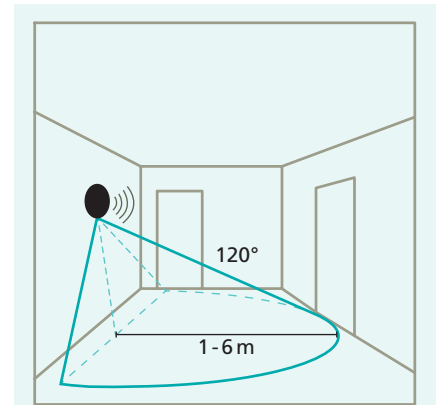

VINCHIO

These luminaires are delivered with a wiring and connection box that is 19.5 mm deep.

Diese Leuchten werden mit einer Verkabelungs- und Anschlussbox mit einer Tiefe von 19,5 mm geliefert.

Cette luminaires sont livrés avec un boîtier de câblage et de connexion d'une profondeur de 19,5 mm.



98501



IP44

97059 PANDELLA 2

mirror light; plastic, silver, chrome / plastic, white
Spiegelleuchte; Kunststoff, silber, chrom / Kunststoff, weiss
applique pour miroir; plastique, argent, chrome / plastique, blanc

L 400, H 75, A 150



7,4W



900lm



IP44



9 002759 970598



98501 VINCHIO

mirror light; steel, chrome / plastic, white
Spiegelleuchte; Stahl, chrom / Kunststoff, weiss
applique pour miroir; acier, chrome / plastique, blanc

L 400, H 50, A 140



9W



1050lm



IP44



9 002759 985011



98502 VINCHIO

mirror light; steel, chrome / plastic, white
Spiegelleuchte; Stahl, chrom / Kunststoff, weiss
applique pour miroir; acier, chrome / plastique, blanc

L 600, H 50, A 140



13,6W



1600lm



IP44



9 002759 985028





98502

LED



IP44

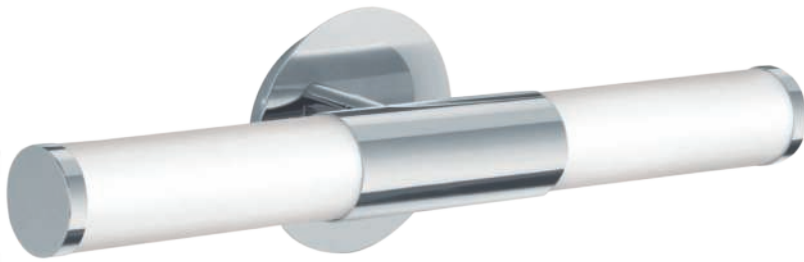

87219



IP44



87222



IP44



83406



83406 | 87219 | 87222

87219 PALMERA

wall light; steel, chrome / matte-opal glass, white
Wandleuchte; Stahl, chrom / Glas opal-matt, weiss
Applique; acier, chrome / verre opale mat, blanc

L 460, A 110



E14



2x 40W



IP44



9 002759 872199



L 460

87222 PALMERA

wall light; steel, satin nickel / matte-opal glass, white
Wandleuchte; Stahl, nickel-matt / Glas opal-matt, weiss
Applique; acier, nickel mat / verre opale mat, blanc

L 460, A 110



E14



2x 40W



IP44



9 002759 872229



L 460

83406 ZOLA

wall light; steel / matte-opal glass, white
Wandleuchte; Stahl / Glas opal-matt, weiss
Applique; acier / verre opale mat, blanc

L 390, B 80



E14



2x 40W



9 002759 834067

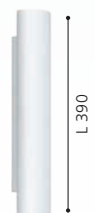

B 80

L 390



94987



85832

94987 BARI 1

mirror light; plastic, white / grooved glass, white
Spiegelleuchte; Kunststoff, weiss / Glas gerillt, weiss
applique pour miroir; plastique, blanc / verre rainuré, blanc

L 350, B 60, A 85



E14 2x 25W



9 002759 949877



85832 STICKER

mirror light; steel, chrome / matte-opal glass, white
Spiegelleuchte; Stahl, chrom / Glas opal-matt, weiss
applique pour miroir; acier, chrome / verre opale mat, blanc

L 70, H 115, A 95



E14 1x 40W



9 002759 858322



94987

These luminaires are equipped with an integrated socket.

Diese Leuchten sind mit einer integrierten Steckdose ausgestattet.

Ces luminaires sont équipés d'une prise de courant intégrée.



99774



IP44



99772



IP44

99774 BUENAVISTA

mirror light; aluminium, silver / mirror
Spiegelleuchte; Alu, silber / Spiegel
applique pour miroir; aluminium, argent / miroir

Ø 600, A 30



15,3W



1700lm



IP44



9 002759 997748



Ø 600

99772 BUENAVISTA

mirror light; aluminium, silver / mirror
Spiegelleuchte; Alu, silber / Spiegel
applique pour miroir; aluminium, argent / miroir

L 500, H 700, A 30



2x 6,1W



1300lm



IP44



9 002759 997724

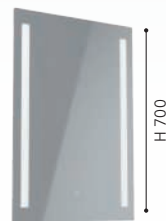

L 500

H 700

99773 BUENAVISTA

mirror light; aluminium, silver / mirror
Spiegelleuchte; Alu, silber / Spiegel
applique pour miroir; aluminium, argent / miroir

L 800, H 600, A 30



2x 5,1W



1100lm



IP44



9 002759 997731



L 800

H 600

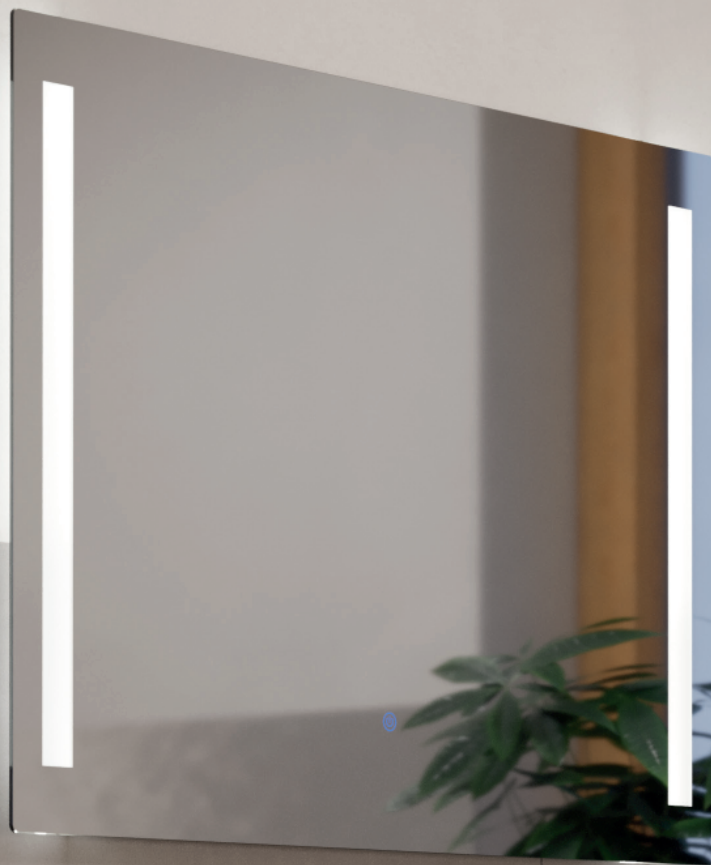

99773



IP44





99838



IP44



99839



IP44

99838 BUENAVISTA 1

mirror light; aluminium, silver / mirror
Spiegelleuchte; Alu, silber / Spiegel
applique pour miroir; aluminium, argent / miroir

L 500, H 700, A 30



15,7W



1700lm



IP44



9 002759 998387



L 500

H 700

99839 BUENAVISTA 1

mirror light; aluminium, silver / mirror
Spiegelleuchte; Alu, silber / Spiegel
applique pour miroir; aluminium, argent / miroir

L 800, H 600, A 30



18,6W



2030lm



IP44



9 002759 998394

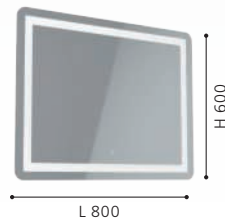

L 800

H 600

99853 BUENAVISTA 2

mirror light; aluminium, silver / mirror
Spiegelleuchte; Alu, silber / Spiegel
applique pour miroir; aluminium, argent / miroir

L 500, H 700, A 30



4x 7,1W



3000lm



IP44



9 002759 998530



L 500

H 700



99853



IP44



99854



IP44

99854 BUENAVISTA 2

mirror light; aluminium, silver / mirror

Spiegelleuchte; Alu, silber / Spiegel

applique pour miroir; aluminium, argent / miroir

L 800, H 600, A 30



4x 6,2 W



2600lm



IP44



9 002759 998547

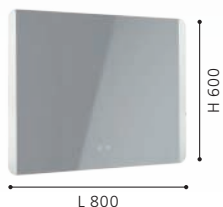

L 800

H 600

BUENAVISTA 2

The additional anti-fog function prevents the mirrors from fogging up and ensures a clear view after showering.

Die zusätzliche Anti-Fog-Funktion verhindert das Beschlagen der Spiegel und sorgt für eine klare Sicht nach dem Duschen.

La fonction anti-buée supplémentaire empêche la formation de buée sur les miroirs et garantit une vision claire après la douche.



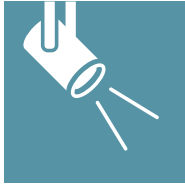

SPOT & TRACK LUMINAIRES

SPOT- & SCHIENENLEUCHTEN
SPOT & LUMINAIRES SUR RAIL



EN SYSTEMATIC LIGHTING

Our spot & track luminaires set specific highlights while optimally lighting your living rooms. No matter whether you prefer a modern or a traditional look – our range will fit any taste.

DE BELEUCHTUNG MIT SYSTEM

Mit unseren Spot- & Schienenleuchten setzen Sie gezielt Lichtakzente und sorgen zugleich für eine optimale Ausleuchtung Ihrer Wohnräume. Egal ob modern oder traditionell - unser Sortiment trifft jeden Geschmack.

FR UN ÉCLAIRAGE AVEC SYSTÈME

Nos spots et nos luminaires sur rail vous permettent d'offrir des accents ponctuels de lumière et assurent parallèlement un éclairage optimal de vos pièces d'habitat. Qu'ils soient modernes ou traditionnels - notre gamme répond à tous les goûts.





OVERVIEW

SPOT & TRACK LUMINAIRES
SPOT- & SCHIENENLEUCHTEN
SPOT & LUMINAIRES



TOWNSHEND 3
682-685



BATALLAS
686-687



COTORRO
689



ESTEPERRA
690



VALBIANO
691



POLLICA
692



BERREGAS
694



CONSACA
696



CASIBARE
698



COSWARTH
700



ARRECIFE
703



CAROVIGNO
704



SAMBATELLO
706-709



COLSLADA
710



GIRONA
713



TABILLANO
714



ZAPATA 1
716



ZAPATA
719



SERAS 1
720-721



SERAS
722-723, 726-727



SERAS 2
724-725



DAKAR 1
728-729



ENEA
730-731



CORATO
733



BARNHAM
734-735



NOCITO
736-737



BIMEDA
738-741



LOCANDA
739



CAYUCA
743



SOREGO
744



VERGHIANO
745



DAVIDA
746-747



DAVIDA 1
748-749



SARRIA
750-753



ZERACO
753



ROTTELO
754-755



BUZZ-LED
756-761



MAGNUM-LED
762-763



CABO 1
764

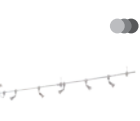

VILANOVA
764-765



CARDILLIO 1
766-767, 769



CARDILLIO 2
768-769



SALTO
770-771



This product is available in different colors and shapes. / Dieser Artikel ist in unterschiedlichen Farben und Formen verfügbar. / Cet article est disponible en différentes couleurs et formes.





33169 TOWNSHEND 3

spot; wood, steel, brown, white
 Spot; Holz, Stahl, braun, weiss
 spot; bois, acier, marron, blanc

L 300, B 50



E27

2x 60W

33171 TOWNSHEND 3

spot; wood, steel, brown, white
 Spot; Holz, Stahl, braun, weiss
 spot; bois, acier, marron, blanc

L 480, B 50



E27

3x 60W

33172 TOWNSHEND 3

spot; wood, steel, brown, white
 Spot; Holz, Stahl, braun, weiss
 spot; bois, acier, marron, blanc

L 630, B 50



E27

4x 60W



9 002759 331696

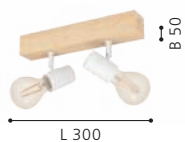

9 002759 331719

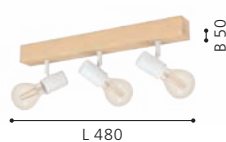

9 002759 331726

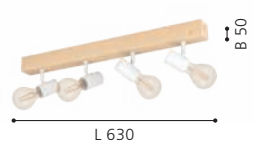



33172



33168

33168 TOWNSHEND 3

spot; wood, steel, brown, white
 Spot; Holz, Stahl, braun, weiss
 spot; bois, acier, marron, blanc

L 165, B 50



E27



1x 10W



9 002759 331689

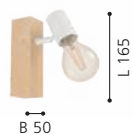



98112



98113

98112 TOWNSHEND 3

spot; wood, steel, brown, black
Spot; Holz, Stahl, braun, schwarz
spot; bois, acier, marron, noir

L 300, B 50



E27



2x 60W

98113 TOWNSHEND 3

spot; wood, steel, brown, black
Spot; Holz, Stahl, braun, schwarz
spot; bois, acier, marron, noir

L 480, B 50



E27



3x 60W

98114 TOWNSHEND 3

spot; wood, steel, brown, black
Spot; Holz, Stahl, braun, schwarz
spot; bois, acier, marron, noir

L 630, B 50



E27



4x 60W



9 002759 981129

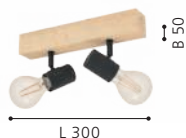

L 300



9 002759 981136



L 480



9 002759 981143



L 630



98114



98111

98111 TOWNSHEND 3

spot; wood, steel, brown, black
 Spot; Holz, Stahl, braun, schwarz
 spot; bois, acier, marron, noir

L 165, B 50



E27



1x 10W



9 002759 981112

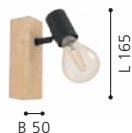



99488



99489



99491



99488 BATALLAS

spot; wood, steel, brown, black / fabric, black, white
 Spot; Holz, Stahl, braun, schwarz / Textil, schwarz, weiss
 spot; bois, acier, marron, noir / tissu, noir, blanc

L 100, H 170, A 205



E27

1x 10W

99489 BATALLAS

spot; wood, steel, brown, black / fabric, black, white
 Spot; Holz, Stahl, braun, schwarz / Textil, schwarz, weiss
 spot; bois, acier, marron, noir / tissu, noir, blanc

L 300, B 50



E27

2x 10W

99491 BATALLAS

spot; wood, steel, brown, black / fabric, black, white
 Spot; Holz, Stahl, braun, schwarz / Textil, schwarz, weiss
 spot; bois, acier, marron, noir / tissu, noir, blanc

L 480, B 50



E27

3x 10W



9 002759 994884



9 002759 994891

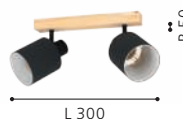

9 002759 994914

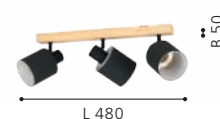



99492



99492 BATALLAS

spot; wood, steel, brown, black / fabric, black, white
 Spot; Holz, Stahl, braun, schwarz / Textil, schwarz, weiss
 spot; bois, acier, marron, noir / tissu, noir, blanc

L 630, B 50



E27



4x 10W



9 002759 994921

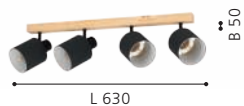



900433





900432



COTORRO



900434



900433 COTORRO

spot; wood, steel, brown, black
Spot; Holz, Stahl, braun, schwarz
spot; bois, acier, marron, noir

L 840, B 145, H 230



E27 3x 25W

900432 COTORRO

spot; wood, steel, brown, black
Spot; Holz, Stahl, braun, schwarz
spot; bois, acier, marron, noir

L 540, B 145, H 230



E27 2x 25W

900434 COTORRO

spot; wood, steel, brown, black
Spot; Holz, Stahl, braun, schwarz
spot; bois, acier, marron, noir

L 145, H 220, A 230



E27 1x 25W



9 008606 243891



9 008606 243884



9 008606 243907

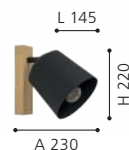



99276

99277



99278

99276 ESTEPERRA

spot; steel, black / fabric, black, gold
 Spot; Stahl, schwarz / Textil, schwarz, gold
 spot; acier, noir / tissu, noir, or

H 240, Ø 120



99277 ESTEPERRA

spot; steel, black / fabric, black, gold
 Spot; Stahl, schwarz / Textil, schwarz, gold
 spot; acier, noir / tissu, noir, or

L 335, B 90



99278 ESTEPERRA

spot; steel, black / fabric, black, gold
 Spot; Stahl, schwarz / Textil, schwarz, gold
 spot; acier, noir / tissu, noir, or

L 575, B 90



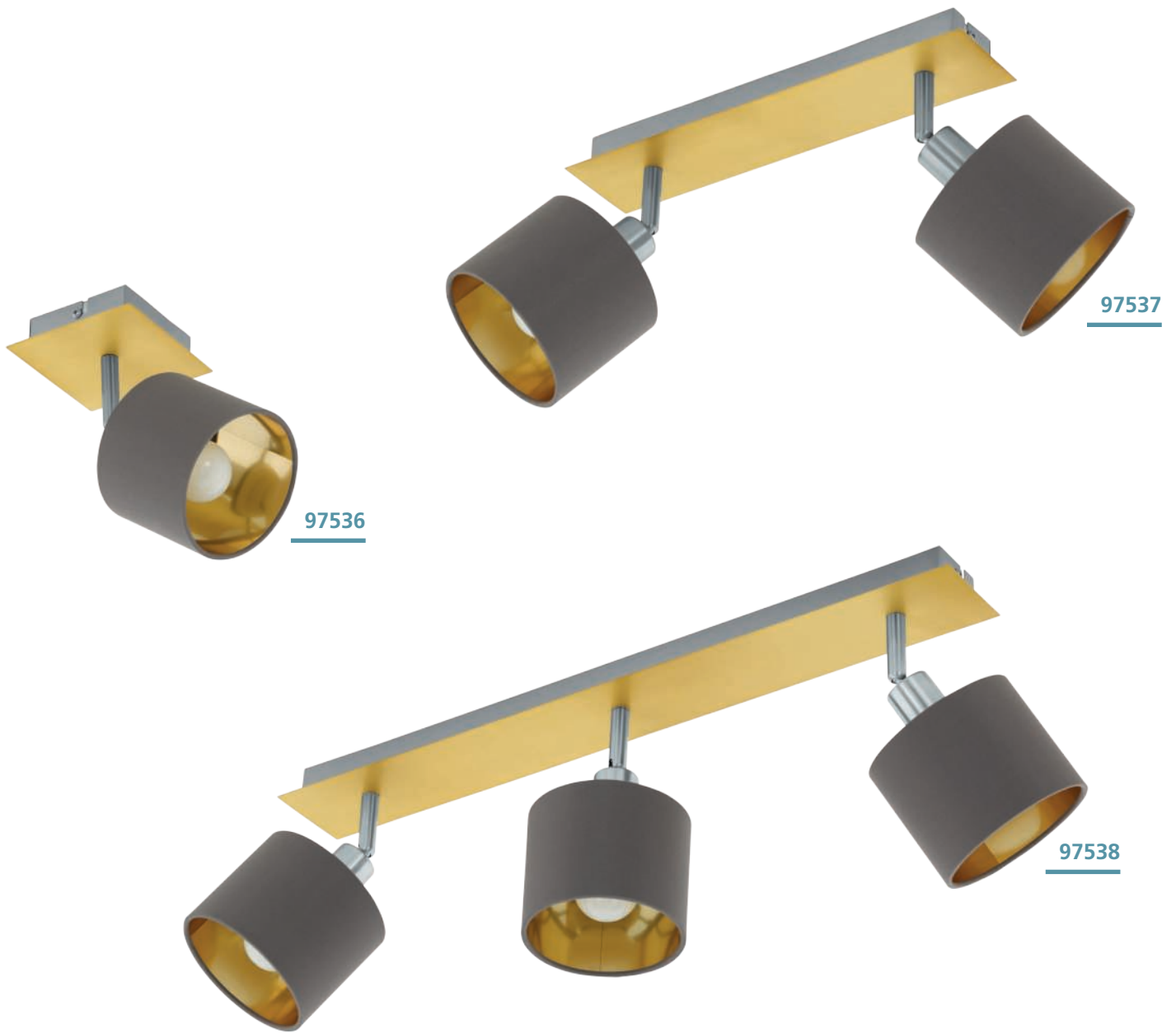

97536 VALBIANO

spot; steel, brushed brass, satin nickel / fabric, cappuccino, gold
 Spot; Stahl, messing-gebürstet, nickel-matt / Textil, cappuccino, gold
 spot; acier, laiton brossé, nickel mat / tissu, cappucino, or

L 110, B 110



E14 1x 7W

97537 VALBIANO

spot; steel, brushed brass, satin nickel / fabric, cappuccino, gold
 Spot; Stahl, messing-gebürstet, nickel-matt / Textil, cappuccino, gold
 spot; acier, laiton brossé, nickel mat / tissu, cappucino, or

L 320, B 70



E14 2x 7W

97538 VALBIANO

spot; steel, brushed brass, satin nickel / fabric, cappuccino, gold
 Spot; Stahl, messing-gebürstet, nickel-matt / Textil, cappuccino, gold
 spot; acier, laiton brossé, nickel mat / tissu, cappucino, or

L 560, B 70



E14 3x 7W



9 002759 975364

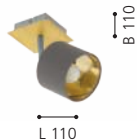

L 110



9 002759 975371

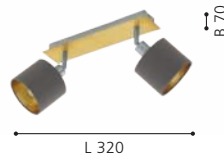

L 320



9 002759 975388

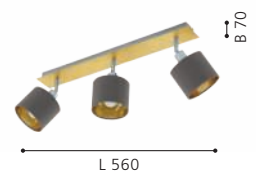

L 560



98624



98625

98624 POLLICA

spot; steel, black / glass vaporized, black-transparent
Spot; Stahl, schwarz / Glas bedampft, schwarz-transparent
spot; acier, noir / verre vaporisé, noir transparent

L 65, H 105



E14

1x 10W

98625 POLLICA

spot; steel, black / glass vaporized, black-transparent
Spot; Stahl, schwarz / Glas bedampft, schwarz-transparent
spot; acier, noir / verre vaporisé, noir transparent

L 365, B 165



E14

2x 28W

98626 POLLICA

spot; steel, black / glass vaporized, black-transparent
Spot; Stahl, schwarz / Glas bedampft, schwarz-transparent
spot; acier, noir / verre vaporisé, noir transparent

L 640, B 220



E14

4x 28W



9 002759 986247



9 002759 986254



9 002759 986261





98626





99052



99053

99052 BERREGAS

spot; steel, black, chrome / glass vaporized, black-transparent
 Spot; Stahl, schwarz, chrom / Glas bedampft, schwarz-transparent
 spot; acier, noir, chrome / verre vaporisé, noir transparent

Ø 110



E27

1x 28W



99053 BERREGAS

spot; steel, black, chrome / glass vaporized, black-transparent
 Spot; Stahl, schwarz, chrom / Glas bedampft, schwarz-transparent
 spot; acier, noir, chrome / verre vaporisé, noir transparent

L 440, B 110



E27

2x 40W



99054 BERREGAS

spot; steel, black, chrome / glass vaporized, black-transparent
 Spot; Stahl, schwarz, chrom / Glas bedampft, schwarz-transparent
 spot; acier, noir, chrome / verre vaporisé, noir transparent

L 775, B 110



E27

3x 40W





99054



99711 CONSACA

spot; steel, black / glass vaporized, black-transparent
 Spot; Stahl, schwarz / Glas bedampft, schwarz-transparent
 spot; acier, noir / verre vaporisé, noir transparent

L 120, H 220, A 235



E27



1x 28W

99713 CONSACA

spot; steel, black / glass vaporized, black-transparent
 Spot; Stahl, schwarz / Glas bedampft, schwarz-transparent
 spot; acier, noir / verre vaporisé, noir transparent

L 780, H 205, A 235



E27



4x 40W

99712 CONSACA

spot; steel, black / glass vaporized, black-transparent
 Spot; Stahl, schwarz / Glas bedampft, schwarz-transparent
 spot; acier, noir / verre vaporisé, noir transparent

L 340, H 205, A 235



E27



2x 40W



9 002759 997113

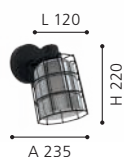

9 002759 997137



9 002759 997120





99712



99517



99518

99517 CASIBARE

spot; steel, black
Spot; Stahl, schwarz
spot; acier, noir

L 120, H 185, A 190



E27



1x 28W

99518 CASIBARE

spot; steel, black
Spot; Stahl, schwarz
spot; acier, noir

L 335, H 175, A 180



E27



2x 28W

99519 CASIBARE

spot; steel, black
Spot; Stahl, schwarz
spot; acier, noir

L 575, H 175, A 180



E27



3x 28W



9 002759 995171



9 002759 995188



9 002759 995195





99519





99075



99076

99075 COSWARTH

spot; steel, wood, anthracite, cream-white, brown
Spot; Stahl, Holz, anthrazit, creme-weiss, braun
spot; acier, bois, gris anthracite, blanc crème,

L 480, B 140, H 240



E27



2x 40W

99076 COSWARTH

spot; steel, wood, anthracite, cream-white, brown
Spot; Stahl, Holz, anthrazit, creme-weiss, braun
spot; acier, bois, gris anthracite, blanc crème,

L 670, B 140, H 240



E27



3x 40W

99074 COSWARTH

spot; steel, wood, anthracite, cream-white, brown
Spot; Stahl, Holz, anthrazit, creme-weiss, braun
spot; acier, bois, gris anthracite, blanc crème,

L 140, H 200



E27



1x 25W



9 002759 990756



L 480



9 002759 990763



L 670



9 002759 990749



L 140



99074



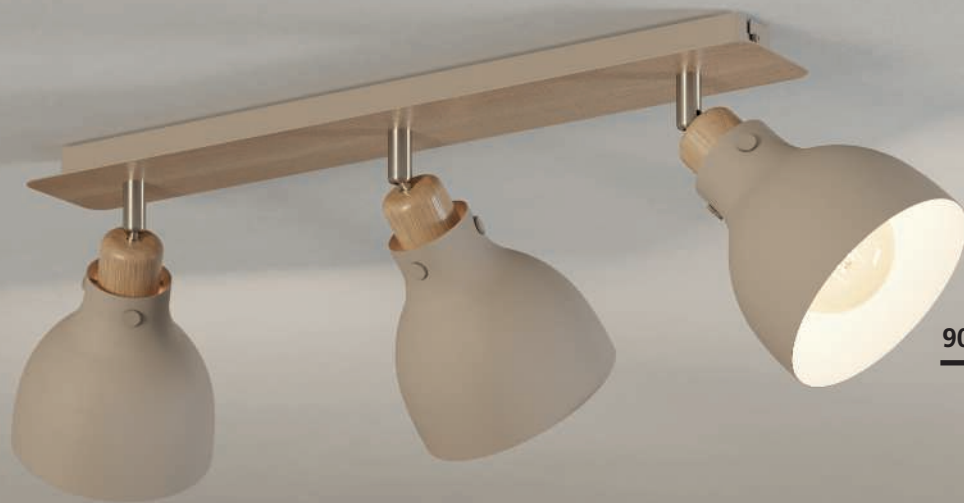

900713



900712



900711

900713 ARRECIFE

spot; steel, brown, satin nickel / steel, sandy
 Spot; Stahl, braun, nickel-matt / Stahl, sandfarben
 spot; acier, marron, nickel mat / acier, couleur sable

L 745, B 145, H 235



E27 3x 28W



9 008606 262045



900712 ARRECIFE

spot; steel, brown, satin nickel / steel, sandy
 Spot; Stahl, braun, nickel-matt / Stahl, sandfarben
 spot; acier, marron, nickel mat / acier, couleur sable

L 531, B 145, H 235



E27 2x 28W



9 008606 262038



900711 ARRECIFE

spot; steel, brown, satin nickel / steel, sandy
 Spot; Stahl, braun, nickel-matt / Stahl, sandfarben
 spot; acier, marron, nickel mat / acier, couleur sable

H 235, Ø 145



E27 1x 28W



9 008606 262021

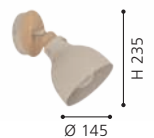



98621 CAROVIGNO

spot; steel, black
Spot; Stahl, schwarz
spot; acier, noir

L 65, H 105



E14

1x 28W

98623 CAROVIGNO

spot; steel, black
Spot; Stahl, schwarz
spot; acier, noir

L 640, B 150



E14

4x 40W

98622 CAROVIGNO

spot; steel, black
Spot; Stahl, schwarz
spot; acier, noir

L 365, B 150



E14

2x 40W



9 002759 986216



9 002759 986230



9 002759 986223



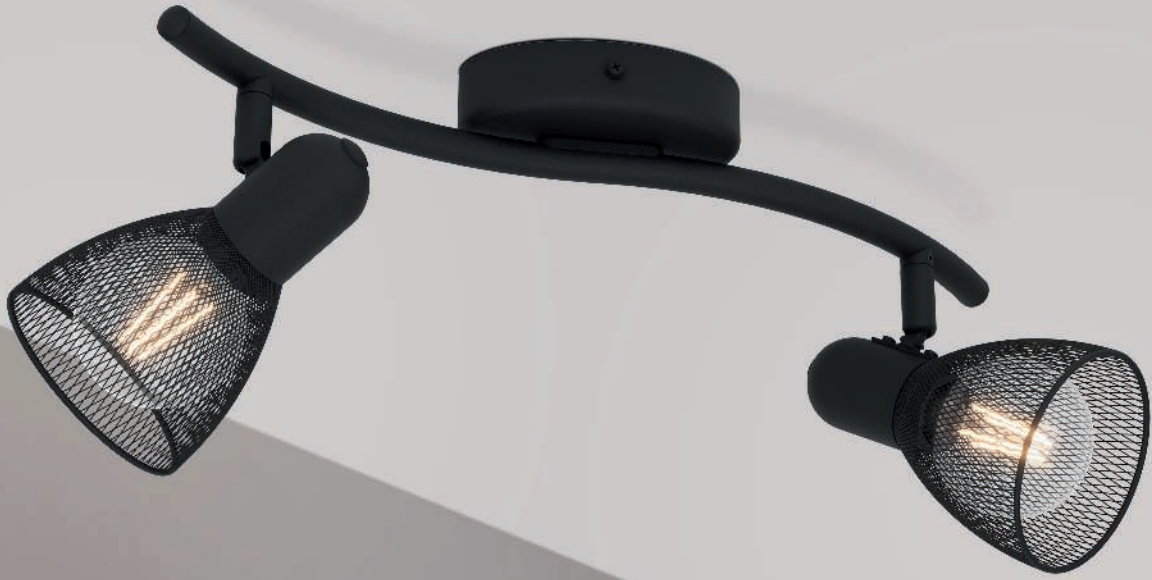

98622



98134



98135



98137

98134 SAMBATELLO

spot; wood, steel, brown, silver / steel, silver
 Spot; Holz, Stahl, braun, silber / Stahl, silber
 spot; bois, acier, marron, argent / acier, argent

L 150, H 220, A 240



E27



1x 40W



9 002759 981341

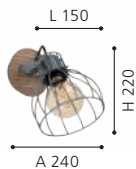

98135 SAMBATELLO

spot; wood, steel, brown, silver / steel, silver
 Spot; Holz, Stahl, braun, silber / Stahl, silber
 spot; bois, acier, marron, argent / acier, argent

L 335, B 90



E27



2x 40W



9 002759 981358

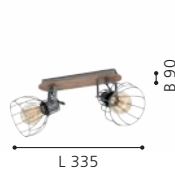

98137 SAMBATELLO

spot; wood, steel, brown, silver / steel, silver
 Spot; Holz, Stahl, braun, silber / Stahl, silber
 spot; bois, acier, marron, argent / acier, argent

L 795, B 90



E27



4x 40W



9 002759 981372



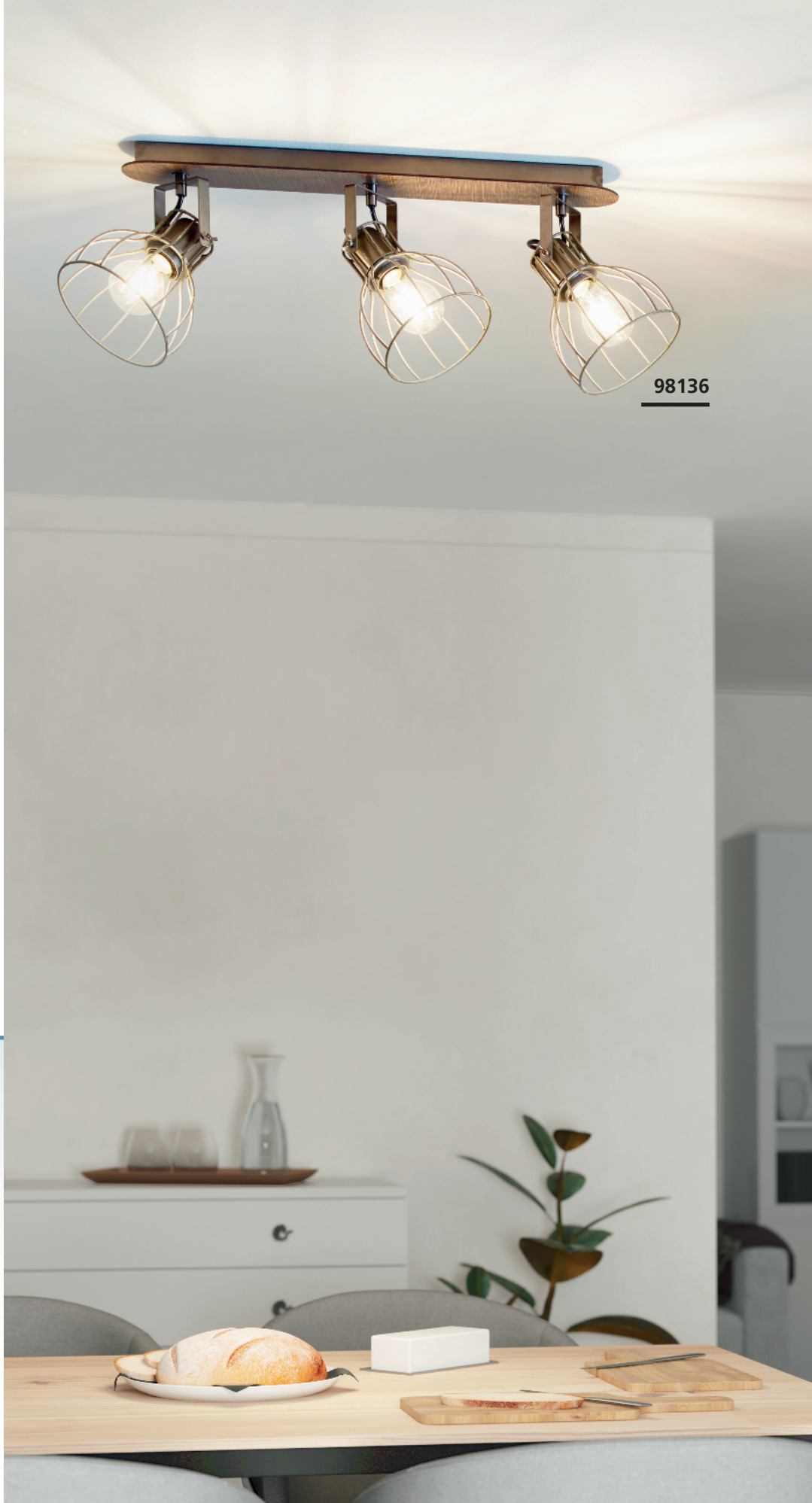

98136

98136 SAMBATELLO

spot; wood, steel, brown, silver / steel, silver
Spot; Holz, Stahl, braun, silber / Stahl, silber
spot; bois, acier, marron, argent / acier, argent

L 575, B 90



E27



3x 40W



9 002759 981365





900382





900382 SAMBATELLO

spot; steel, wood, black, brushed brass
 Spot; Stahl, Holz, schwarz, messing-gebürstet
 spot; acier, bois, noir, laiton brossé

L 260, B 150, H 220



900383 SAMBATELLO

spot; steel, wood, black, brushed brass
 Spot; Stahl, Holz, schwarz, messing-gebürstet
 spot; acier, bois, noir, laiton brossé

L 480, B 280, H 260

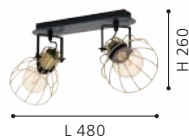

900384 SAMBATELLO

spot; steel, wood, black, brushed brass
 Spot; Stahl, Holz, schwarz, messing-gebürstet
 spot; acier, bois, noir, laiton brossé

L 700, B 280, H 260





900693



900694



EGLO
RECOMMENDS
110052
COSLADA

900693 COSLADA

spot; steel, black / steel, black, brass
Spot; Stahl, schwarz / Stahl, schwarz, messing
spot; acier, noir / acier, noir, laiton

L 130, H 200, A 170



E27



1x 40W

900694 COSLADA

spot; steel, black / steel, black, brass
Spot; Stahl, schwarz / Stahl, schwarz, messing
spot; acier, noir / acier, noir, laiton

L 320, B 80, H 170



E27



2x 40W

900695 COSLADA

spot; steel, black / steel, black, brass
Spot; Stahl, schwarz / Stahl, schwarz, messing
spot; acier, noir / acier, noir, laiton

L 790, B 80, H 170



E27



4x 40W



9 008606 262052



9 008606 262069



9 008606 262076





900695





900662



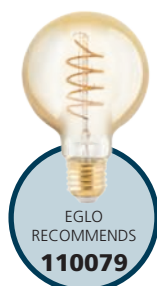

GIRONA



900661



900663

900662 GIRONA

spot; steel, black, brushed brass
Spot; Stahl, schwarz, messing-gebürstet
spot; acier, noir, laiton brossé

L 440, B 190, H 150



E27 2x 40W

900661 GIRONA

spot; steel, black, brushed brass
Spot; Stahl, schwarz, messing-gebürstet
spot; acier, noir, laiton brossé

L 190, B 140, H 150



E27 1x 40W

900663 GIRONA

spot; steel, black, brushed brass
Spot; Stahl, schwarz, messing-gebürstet
spot; acier, noir, laiton brossé

L 775, B 190, H 150



E27 3x 40W



9 008606 258598



L 440

H 150



9 008606 258581



L 190

H 150



9 008606 258604



L 775

H 150



98763 TABILLANO

spot; steel, black
Spot; Stahl, schwarz
spot; acier, noir

L 440, B 110



E27

2x 40W

98764 TABILLANO

spot; steel, black
Spot; Stahl, schwarz
spot; acier, noir

L 775, B 110



E27

3x 40W

98762 TABILLANO

spot; steel, black
Spot; Stahl, schwarz
spot; acier, noir

Ø 110



E27

1x 40W



9 002759 987633

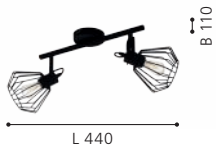

9 002759 987640

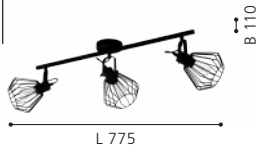

9 002759 987626





98762





32765

LED



32767

LED

32765 ZAPATA 1

spot; steel, black / glass, amber
Spot; Stahl, schwarz / Glas, amber
spot; acier, noir / verre, ambre

Ø 60



G9



1x 3W



1x
320lm

32767 ZAPATA 1

spot; steel, black / glass, amber
Spot; Stahl, schwarz / Glas, amber
spot; acier, noir / verre, ambre

L 635, B 65



G9



4x 3W



4x
320lm

32766 ZAPATA 1

spot; steel, black / glass, amber
Spot; Stahl, schwarz / Glas, amber
spot; acier, noir / verre, ambre

L 360, B 65



G9



2x 3W



2x
320lm



9 002759 327651



Ø 60



9 002759 327675



L 635

B 65



9 002759 327668



L 360

B 65



32766

LED





95547

LED

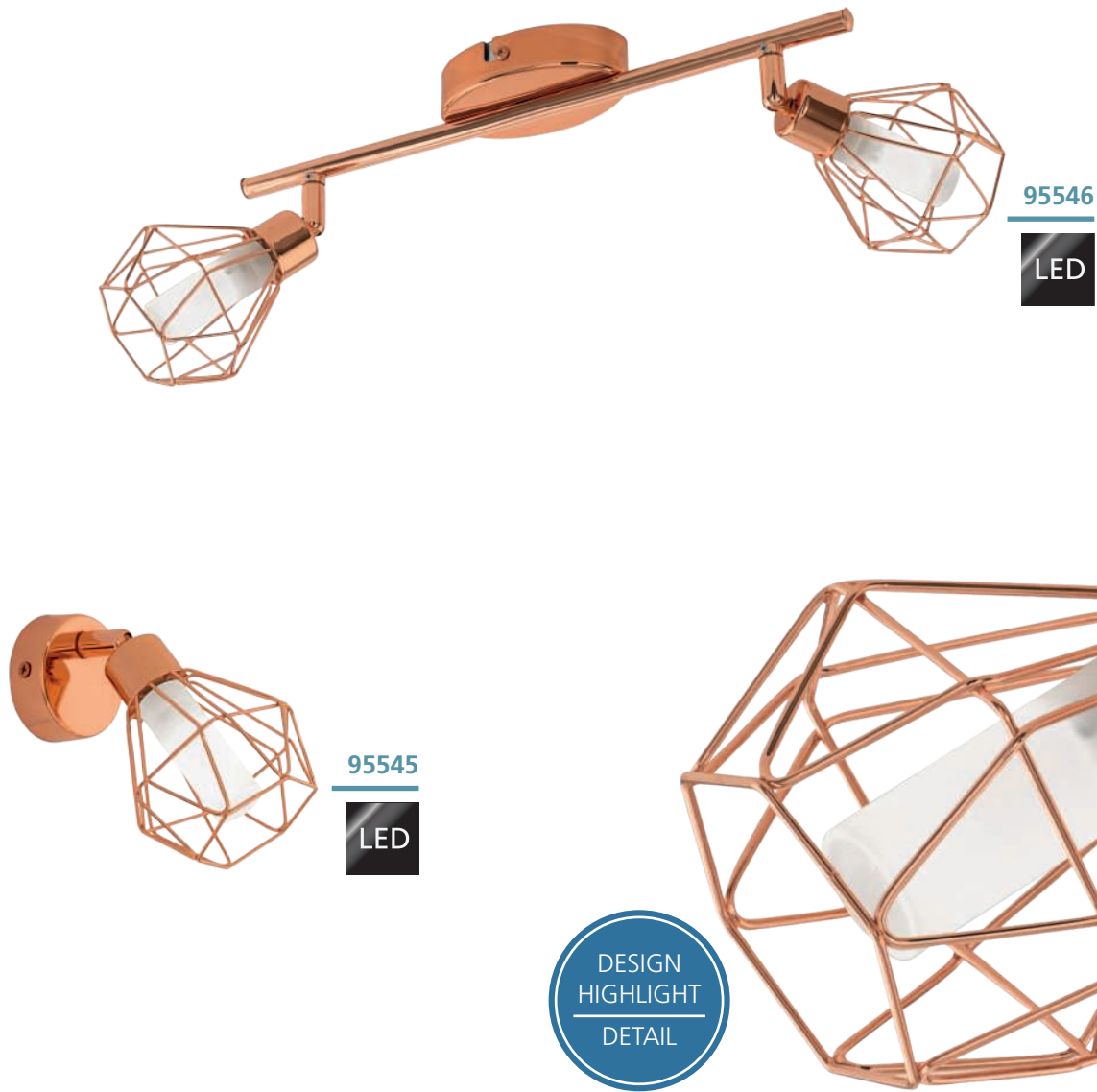

95546

LED

95545

LED

DESIGN
HIGHLIGHT
DETAIL

95547 ZAPATA

spot; steel, copper / satin glass, white
Spot; Stahl, kupfer / Glas satiniert, weiss
spot; acier, cuivre / verre satiné, blanc

L 515, B 65

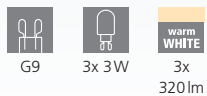

G9 3x 3W 3x warm WHITE 320lm



95546 ZAPATA

spot; steel, copper / satin glass, white
Spot; Stahl, kupfer / Glas satiniert, weiss
spot; acier, cuivre / verre satiné, blanc

L 360, B 65

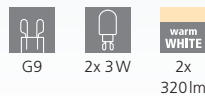

G9 2x 3W 2x warm WHITE 320lm

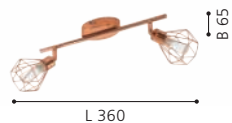

95545 ZAPATA

spot; steel, copper / satin glass, white
Spot; Stahl, kupfer / Glas satiniert, weiss
spot; acier, cuivre / verre satiné, blanc

Ø 60

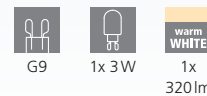

G9 1x 3W 1x warm WHITE 320lm





98393

LED



98394

LED



98396

LED

98393 SERAS 1

spot; steel, white
Spot; Stahl, weiss
spot; acier, blanc

Ø 100



GU10



1x 3W



1x
warm
WHITE
250lm

98394 SERAS 1

spot; steel, white
Spot; Stahl, weiss
spot; acier, blanc

L 370, B 65



GU10



2x 3W



2x
warm
WHITE
250lm

98396 SERAS 1

spot; steel, white
Spot; Stahl, weiss
spot; acier, blanc

L 770, B 65



GU10



4x 3W



4x
warm
WHITE
250lm



9 002759 983932



Ø 100



9 002759 983949



L 370



9 002759 983963



L 770



98395

LED

98395 SERAS 1

spot; steel, white
Spot; Stahl, weiss
spot; acier, blanc

L 595, B 65



GU10



3x 3W



warm
WHITE
3x
250lm



9 002759 983956

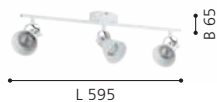



96552

LED



DESIGN
HIGHLIGHT
DETAIL

96552 SERAS

spot; steel, antique nickel, cream
Spot; Stahl, nickel-antik, creme
spot; acier, nickel antique, crème

Ø 100



GU10



1x 3W



1x

250lm



9 002759 965525



INCL.



Ø 100



96553

LED



96554

LED



96555

LED

96553 SERAS

spot; steel, antique nickel, cream
Spot; Stahl, nickel-antik, creme
spot; acier, nickel antique, crème

L 370, B 65



GU10



2x 3W



warm
WHITE

2x

250lm

96554 SERAS

spot; steel, antique nickel, cream
Spot; Stahl, nickel-antik, creme
spot; acier, nickel antique, crème

L 595, B 65



GU10



3x 3W



warm
WHITE

3x

250lm

96555 SERAS

spot; steel, antique nickel, cream
Spot; Stahl, nickel-antik, creme
spot; acier, nickel antique, crème

L 770, B 65



GU10



4x 3W



warm
WHITE

4x

250lm



9 002759 965532



L 370



9 002759 965549



L 595



9 002759 965556



L 770



98398

LED



98397

LED

98398 SERAS 2

spot; steel, black
Spot; Stahl, schwarz
spot; acier, noir

L 370, B 65



GU10



2x 3W



warm
WHITE
2x
250lm



9 002759 983987





98399

LED



98408

LED

98397 SERAS 2

spot; steel, black
Spot; Stahl, schwarz
spot; acier, noir

Ø 100



GU10



1x 3W



1x
warm
WHITE
250lm

98399 SERAS 2

spot; steel, black
Spot; Stahl, schwarz
spot; acier, noir

L 595, B 65



GU10



3x 3W



3x
warm
WHITE
250lm

98408 SERAS 2

spot; steel, black
Spot; Stahl, schwarz
spot; acier, noir

L 770, B 65



GU10



4x 3W



4x
warm
WHITE
250lm



9 002759 983970



Ø 100



9 002759 983994



L 595

B 65



9 002759 984083



L 770

B 65



900169

LED



900171

LED



900173

LED

900169 SERAS

spot; steel, brushed brass, gold
Spot; Stahl, messing-gebürstet, gold
spot; acier, laiton brossé, or

Ø 100



GU10



1x 3W



1x
warm
WHITE
250lm

900171 SERAS

spot; steel, brushed brass, gold
Spot; Stahl, messing-gebürstet, gold
spot; acier, laiton brossé, or

L 370, B 65



GU10



2x 3W



2x
warm
WHITE
250lm

900173 SERAS

spot; steel, brushed brass, gold
Spot; Stahl, messing-gebürstet, gold
spot; acier, laiton brossé, or

L 770, B 65



GU10



4x 3W



4x
warm
WHITE
250lm



9 008606 235643



9 008606 235650



L 370



9 008606 235674



L 770



900172

LED



900172 SERAS

spot; steel, brushed brass, gold
Spot; Stahl, messing-gebürstet, gold
spot; acier, laiton brossé, or

L 595, B 65



GU10



3x 3W



warm
WHITE
3x
250lm



9 008606 235667

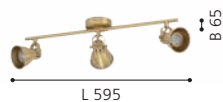

DESIGN
HIGHLIGHT
DETAIL





88472

DESIGN
HIGHLIGHT
DETAIL



88473



88472 DAKAR 1

spot; steel, satin nickel / glass wiping technique, white
Spot; Stahl, nickel-matt / Glas Wischtechnik, weiss
spot; acier, nickel mat / technique de verre essuyé, blanc

L 105, B 65



E14



1x 25W

88473 DAKAR 1

spot; steel, satin nickel / glass wiping technique, white
Spot; Stahl, nickel-matt / Glas Wischtechnik, weiss
spot; acier, nickel mat / technique de verre essuyé, blanc

L 370, B 100



E14



2x 40W



9 002759 884727



L 105



9 002759 884734



L 370

B 100



88474



88475

88474 DAKAR 1

spot; steel, satin nickel / glass wiping technique, white
 Spot; Stahl, nickel-matt / Glas Wischtechnik, weiss
 spot; acier, nickel mat / technique de verre essuyé, blanc

L 650, B 100



E14 4x 40W



9 002759 88474 1



88475 DAKAR 1

spot; steel, satin nickel / glass wiping technique, white
 Spot; Stahl, nickel-matt / Glas Wischtechnik, weiss
 spot; acier, nickel mat / technique de verre essuyé, blanc

Ø 295



E14 3x 40W



9 002759 88475 8

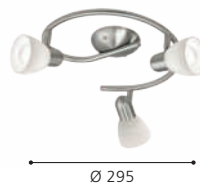



90984 ENEA

spot; steel, satin nickel / satin glass, white
 Spot; Stahl, nickel-matt / Glas satiniert, weiss
 spot; acier, nickel mat / verre satiné, blanc

L 300, B 70



E14 2x 40W

90986 ENEA

spot; steel, satin nickel / satin glass, white
 Spot; Stahl, nickel-matt / Glas satiniert, weiss
 spot; acier, nickel mat / verre satiné, blanc

Ø 265



E14 3x 40W

90985 ENEA

spot; steel, satin nickel / satin glass, white
 Spot; Stahl, nickel-matt / Glas satiniert, weiss
 spot; acier, nickel mat / verre satiné, blanc

L 500, B 70



E14 3x 40W



9 002759 909840



9 002759 909864

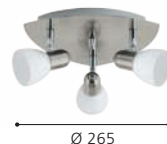

9 002759 909857

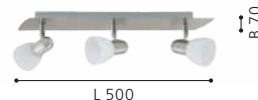



90982

90982 ENEA

spot; steel, satin nickel / satin glass, white
Spot; Stahl, nickel-matt / Glas satiniert, weiss
spot; acier, nickel mat / verre satiné, blanc

L 190, B 70



E14



1x 25W



9 002759 909826





900715



900714



900716

900715 CORATO

spot; steel, sandy, satin nickel / glass, white
 Spot; Stahl, sandfarben, nickel-matt / Glas, weiss
 spot; acier, couleur sable, nickel mat / verre, blanc

L 300, H 125, A 150



E14 2x 18W

900714 CORATO

spot; steel, sandy, satin nickel / glass, white
 Spot; Stahl, sandfarben, nickel-matt / Glas, weiss
 spot; acier, couleur sable, nickel mat / verre, blanc

L 85, H 125, A 150



E14 1x 18W

900716 CORATO

spot; steel, sandy, satin nickel / glass, white
 Spot; Stahl, sandfarben, nickel-matt / Glas, weiss
 spot; acier, couleur sable, nickel mat / verre, blanc

L 520, H 125, A 150



E14 3x 18W



9 008606 262120



L 300

H 125



9 008606 262113

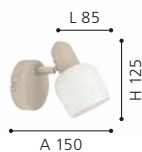

L 85

A 150

H 125



9 008606 262137



L 520

H 125



94585



94586



94585 BARNHAM

spot; steel, black, copper
Spot; Stahl, schwarz, kupfer
spot; acier, noir, cuivre

L 395, B 70

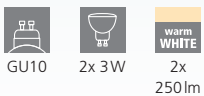

94586 BARNHAM

spot; steel, black, copper
Spot; Stahl, schwarz, kupfer
spot; acier, noir, cuivre

L 585, B 70

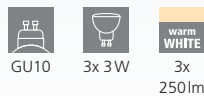

94587 BARNHAM

spot; steel, black, copper
Spot; Stahl, schwarz, kupfer
spot; acier, noir, cuivre

L 780, B 70



L 395



L 585



L 780



94587

LED



94584

LED

94584 BARNHAM

spot; steel, black, copper
 Spot; Stahl, schwarz, kupfer
 spot; acier, noir, cuivre

L 165, B 70



GU10



1x 3W



warm
 WHITE
 1x
 250lm



9 002759 945848



INCL.

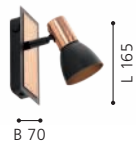



95482

LED



95483

LED



95485

LED

95482 NOCITO

spot; steel, black, gold
Spot; Stahl, schwarz, gold
spot; acier, noir, or

Ø 110



GU10



1x 3W



1x
warm
WHITE
250lm

95483 NOCITO

spot; steel, black, gold
Spot; Stahl, schwarz, gold
spot; acier, noir, or

L 360, B 105



GU10



2x 3W



2x
warm
WHITE
250lm

95485 NOCITO

spot; steel, black, gold
Spot; Stahl, schwarz, gold
spot; acier, noir, or

L 760, B 105



GU10



4x 3W



4x
warm
WHITE
250lm



9 002759 954826



Ø 110



9 002759 954833



L 360

B 105



9 002759 954857



L 760

B 105



95484

LED

95484 NOCITO

spot; steel, black, gold
Spot; Stahl, schwarz, gold
spot; acier, noir, or

L 585, B 105



GU10



3x 3W



warm
WHITE

3x
250lm



9 002759 954840



DESIGN
HIGHLIGHT
DETAIL



31001

LED



31002

LED



31004

LED

31001 BIMEDA

spot; steel, white, chrome
Spot; Stahl, weiss, chrom
spot; acier, blanc, chrome

Ø 70



GU10



1x 2,8W



1x
250lm

31002 BIMEDA

spot; steel, white, chrome
Spot; Stahl, weiss, chrom
spot; acier, blanc, chrome

L 365, B 100



GU10



2x 2,8W



2x
250lm

31004 BIMEDA

spot; steel, white, chrome
Spot; Stahl, weiss, chrom
spot; acier, blanc, chrome

L 640, B 100



GU10



4x 2,8W



4x
250lm



9 002759 310011



Ø 70



9 002759 310028



L 365

B 100



9 002759 310042



L 640

B 100



31003

LED



94252

LED

31003 BIMEDA

spot; steel, white, chrome
Spot; Stahl, weiss, chrom
spot; acier, blanc, chrome

L 290, H 345



GU10



3x 2,8W



warm
WHITE

3x
250lm



9 002759 310035



L 290

H 345

94252 LOCANDA

ceiling light; steel, white, chrome
Deckenleuchte; Stahl, weiss, chrom
plafonnier; acier, blanc, chrome

L 700, B 660



GU10



5x 2,8W



warm
WHITE

5x
250lm



9 002759 942526

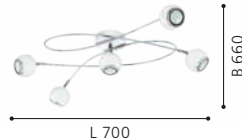

L 700

B 660





31005

LED



DESIGN
HIGHLIGHT
DETAIL

31005 BIMEDA

spot; steel, nickel-nero, chrome
Spot; Stahl, nickel-nero, chrom
spot; acier, nickel brillant, chrome

Ø 70



GU10



1x 2,8W



1x
250lm



9 002759 310059



INCL.





31006

LED



31007

LED



31008

LED

31006 BIMEDA

spot; steel, nickel-nero, chrome
Spot; Stahl, nickel-nero, chrom
spot; acier, nickel brillant, chrome

L 365, B 100



GU10



2x 2,8W



2x
warm
WHITE
250lm



9 002759 310066



L 365

31007 BIMEDA

spot; steel, nickel-nero, chrome
Spot; Stahl, nickel-nero, chrom
spot; acier, nickel brillant, chrome

L 290, H 345



GU10



3x 2,8W



3x
warm
WHITE
250lm



9 002759 310073



L 290

31008 BIMEDA

spot; steel, nickel-nero, chrome
Spot; Stahl, nickel-nero, chrom
spot; acier, nickel brillant, chrome

L 640, B 100



GU10



4x 2,8W



4x
warm
WHITE
250lm



9 002759 310080



L 640



900438

LED



900436



900437



900438 CAYUCA

spot; steel, black / wood, brown
 Spot; Stahl, schwarz / Holz, braun
 spot; acier, noir / bois, marron

L 580, B 100, H 120

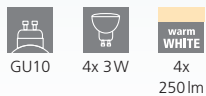

900436 CAYUCA

spot; steel, black / wood, brown
 Spot; Stahl, schwarz / Holz, braun
 spot; acier, noir / bois, marron

L 110, B 105, H 120

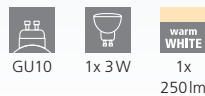

900437 CAYUCA

spot; steel, black / wood, brown
 Spot; Stahl, schwarz / Holz, braun
 spot; acier, noir / bois, marron

L 280, B 100, H 120

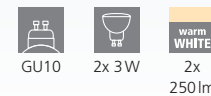

L 580



L 110



L 280



900331



900332



900333



900331 SOREGO

spot; steel, black
Spot; Stahl, schwarz
spot; acier, noir

L 110, B 105, H 120



GU10



1x 3W



1x
warm
WHITE
250lm

900332 SOREGO

spot; steel, black
Spot; Stahl, schwarz
spot; acier, noir

L 280, B 100, H 120



GU10



2x 3W



2x
warm
WHITE
250lm

900333 SOREGO

spot; steel, black
Spot; Stahl, schwarz
spot; acier, noir

L 580, B 100, H 120



GU10



4x 3W



4x
warm
WHITE
250lm



9 008606 239078



L 110



9 008606 239085



L 280



9 008606 239092



L 580



97506

LED



97507

LED



97508

LED

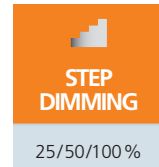

97506

97507

97508

25/50/100%

97506 VERGIANO

spot; aluminium, steel, white, satin nickel
Spot; Alu, Stahl, weiss, nickel-matt
spot; aluminium, acier, blanc, nickel mat

L 70, H 165

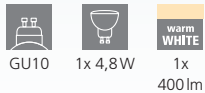

GU10 1x 4,8W 1x 400lm



9 002759 975067



97507 VERGIANO

spot; aluminium, steel, white, satin nickel
Spot; Alu, Stahl, weiss, nickel-matt
spot; aluminium, acier, blanc, nickel mat

L 390, B 70

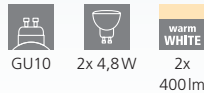

GU10 2x 4,8W 2x 400lm



9 002759 975074

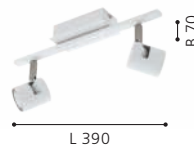

97508 VERGIANO

spot; aluminium, steel, white, satin nickel
Spot; Alu, Stahl, weiss, nickel-matt
spot; aluminium, acier, blanc, nickel mat

L 690, B 70

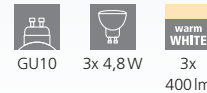

GU10 3x 4,8W 3x 400lm



9 002759 975081

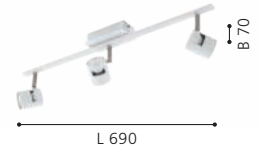



92084

LED



92085

LED



92086

LED

92084 DAVIDA

spot; steel, chrome, white
Spot; Stahl, chrom, weiss
spot; acier, chrome, blanc

L 165, B 70



GU10



1x 4,6W



1x

400lm



92085 DAVIDA

spot; steel, chrome, white
Spot; Stahl, chrom, weiss
spot; acier, chrome, blanc

L 390, B 70



GU10



2x 4,6W



2x

400lm

92086 DAVIDA

spot; steel, chrome, white
Spot; Stahl, chrom, weiss
spot; acier, chrome, blanc

L 580, B 70



GU10



3x 4,6W



3x

400lm



9 002759 920845



L 165

B 70



9 002759 920852



L 390



9 002759 920869



L 580



92087

LED

92087 DAVIDA

spot; steel, chrome, white
Spot; Stahl, chrom, weiss
spot; acier, chrome, blanc

L 780, B 70



GU10



4x 4,6 W



4x
warm
WHITE
400 lm



9 002759 920876



INCL.

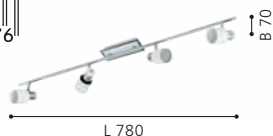

L 780

B 70

DESIGN
HIGHLIGHT
DETAIL





30833

LED



30832

LED

30832 DAVIDA 1

spot; steel, nickel-nero
 Spot; Stahl, nickel-nero
 spot; acier, nickel noir

L 165, B 70



GU10



1x 4,6W



warm
 WHITE

1x

400lm



9 002759 308322



INCL.



B 70

L 165

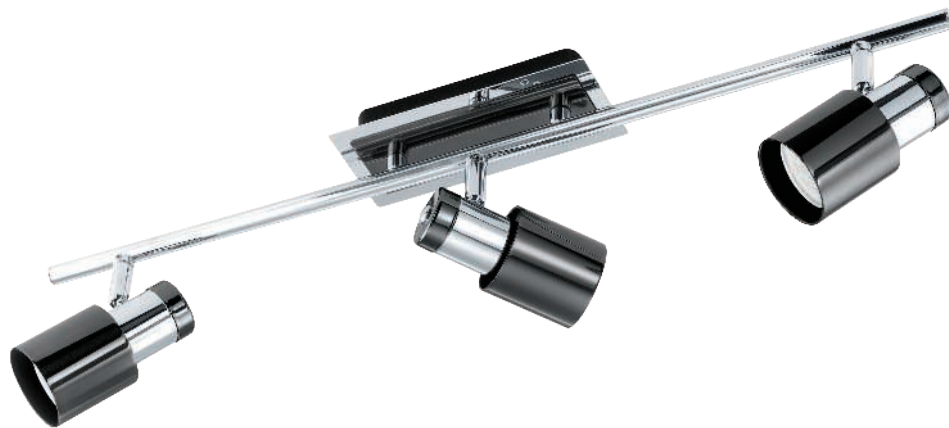

30834

LED

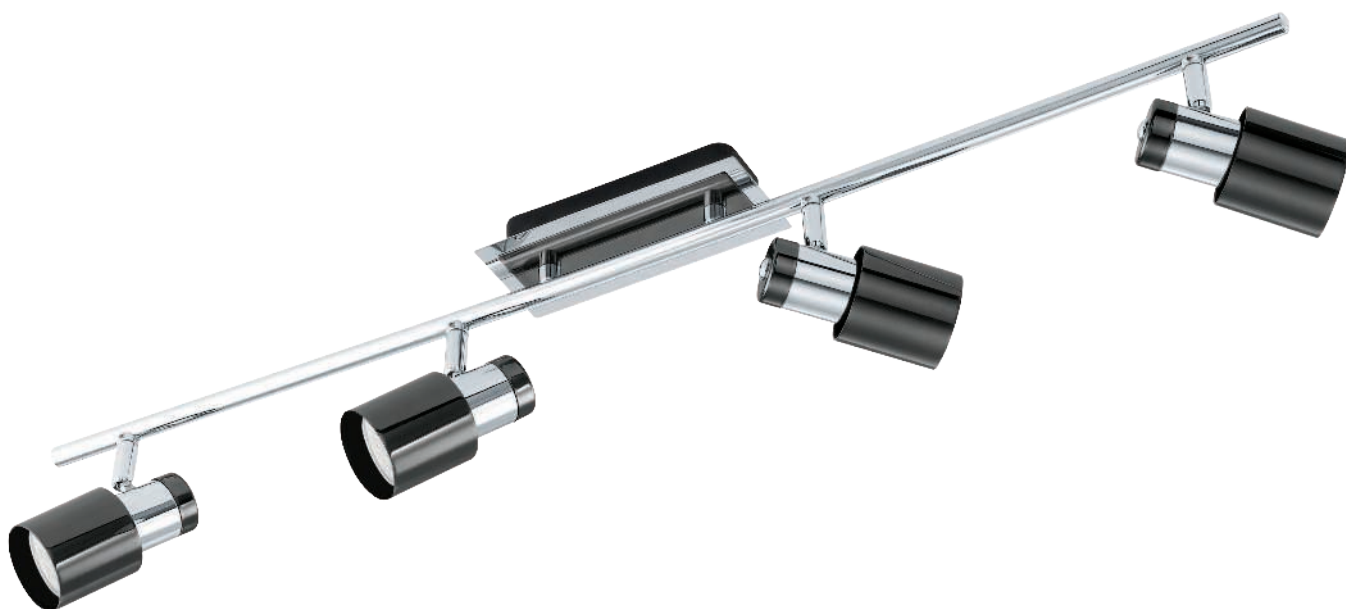

30835

LED

30833 DAVIDA 1

spot; steel, nickel-nero
Spot; Stahl, nickel-nero
spot; acier, nickel noir

L 390, B 70

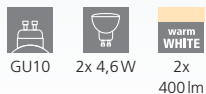

GU10 2x 4,6W 2x warm WHITE 400lm



9 002759 308339



L 390

30834 DAVIDA 1

spot; steel, nickel-nero
Spot; Stahl, nickel-nero
spot; acier, nickel noir

L 580, B 70

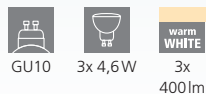

GU10 3x 4,6W 3x warm WHITE 400lm



9 002759 308346



L 580

30835 DAVIDA 1

spot; steel, nickel-nero
Spot; Stahl, nickel-nero
spot; acier, nickel noir

L 780, B 70

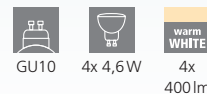

GU10 4x 4,6W 4x warm WHITE 400lm



9 002759 308353



L 780



94962

LED



94958

LED

94962 SARRIA

spot; steel, white, chrome
Spot; Stahl, weiss, chrom
spot; acier, blanc, chrome

L 240, H 260



GU10



4x 4,5W



warm
WHITE

4x

345lm



9 002759 949624



INCL.



L 240

H 260

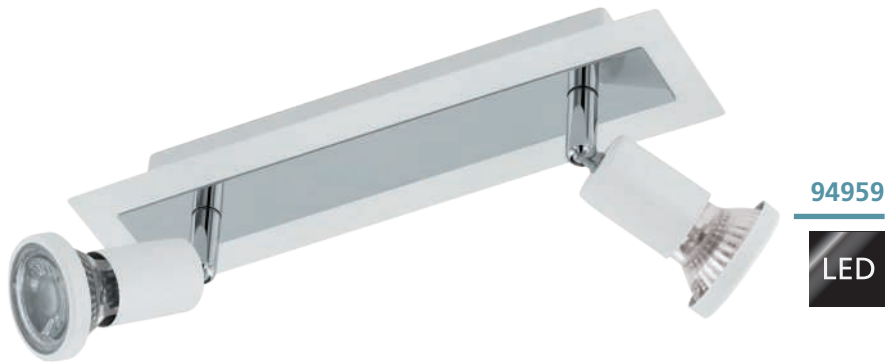

94959

LED



94961

LED

94958 SARRIA

spot; steel, white, chrome
Spot; Stahl, weiss, chrom
spot; acier, blanc, chrome

L 120, B 60

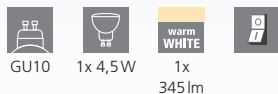

GU10 1x 4,5W 1x 345lm



9 002759 949587



94959 SARRIA

spot; steel, white, chrome
Spot; Stahl, weiss, chrom
spot; acier, blanc, chrome

L 300, B 70

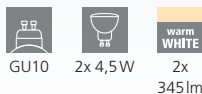

GU10 2x 4,5W 2x 345lm



9 002759 949594

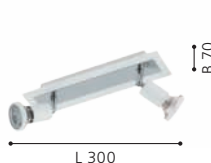

94961 SARRIA

spot; steel, white, chrome
Spot; Stahl, weiss, chrom
spot; acier, blanc, chrome

L 460, B 70

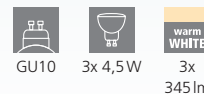

GU10 3x 4,5W 3x 345lm



9 002759 949617





94963



94966



94964



94963 SARRIA

spot; steel, black, chrome
Spot; Stahl, schwarz, chrom
spot; acier, noir, chrome

L 120, B 60

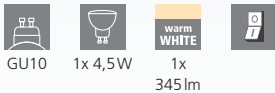

94964 SARRIA

spot; steel, black, chrome
Spot; Stahl, schwarz, chrom
spot; acier, noir, chrome

L 300, B 70

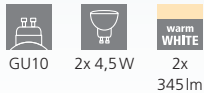

94966 SARRIA

spot; steel, black, chrome
Spot; Stahl, schwarz, chrom
spot; acier, noir, chrome

L 240, H 260

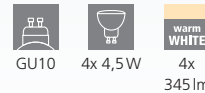

9 002759 949631



9 002759 949648



9 002759 949662





94965

LED

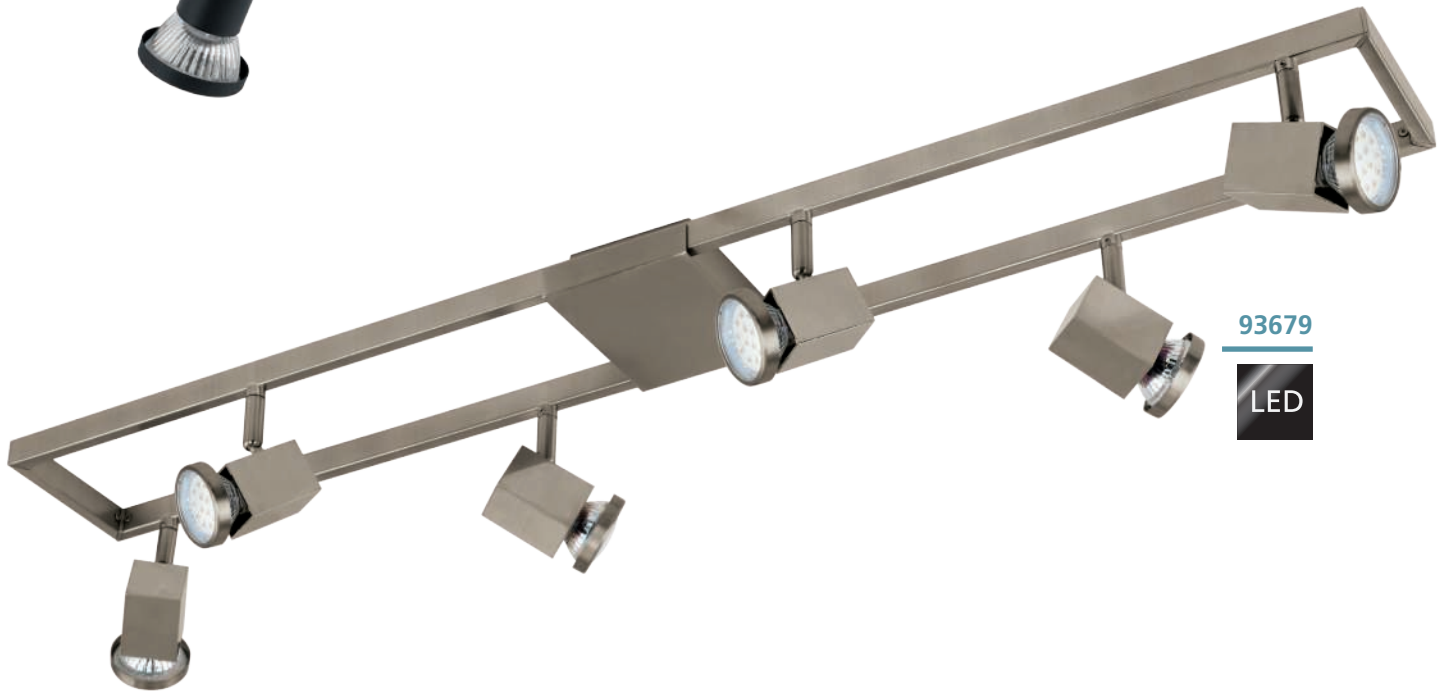

93679

LED

94965 SARRIA

spot; steel, black, chrome
Spot; Stahl, schwarz, chrom
spot; acier, noir, chrome

L 460, B 70

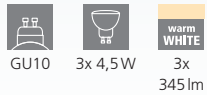

93679 ZERACO

spot; steel, plastic, satin nickel
Spot; Stahl, Kunststoff, nickel-matt
spot; acier, plastique, nickel mat

L 940, B 120

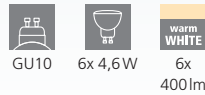

9 002759 949655



L 460



9 002759 936792



L 940



90915

LED



90914

LED



90916

LED

90915 ROTTELO

spot; steel, satin nickel, chrome
Spot; Stahl, nickel-matt, chrom
spot; acier, nickel mat, chrome

L 280, B 70



GU10

2x 4,6W

2x

400lm

90914 ROTTELO

spot; steel, satin nickel, chrome
Spot; Stahl, nickel-matt, chrom
spot; acier, nickel mat, chrome

L 120, B 60



GU10

1x 4,6W

1x

400lm

90916 ROTTELO

spot; steel, satin nickel, chrome
Spot; Stahl, nickel-matt, chrom
spot; acier, nickel mat, chrome

L 260, B 240



GU10

4x 4,6W

4x

400lm



9 002759 909154



L 280



9 002759 909147



B 60



9 002759 909161



L 260



90917



90927



90917 ROTTELO

spot; steel, satin nickel, chrome
 Spot; Stahl, nickel-matt, chrom
 spot; acier, nickel mat, chrome

L 780, B 70

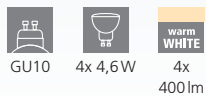

90927 ROTTELO

spot; steel, satin nickel, chrome
 Spot; Stahl, nickel-matt, chrom
 spot; acier, nickel mat, chrome

L 1160, B 70

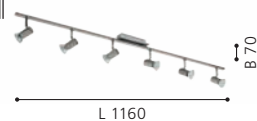
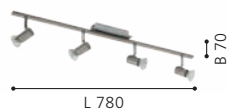
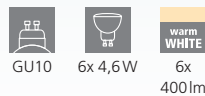



92595

LED



92596

LED



92597

LED

92595 BUZZ-LED

spot; steel, satin nickel
Spot; Stahl, nickel-matt
spot; acier, nickel mat

Ø 60



GU10



1x 2,8W



1x
250lm

92596 BUZZ-LED

spot; steel, satin nickel
Spot; Stahl, nickel-matt
spot; acier, nickel mat

L 285, B 65



GU10



2x 2,8W



2x
250lm

92597 BUZZ-LED

spot; steel, satin nickel
Spot; Stahl, nickel-matt
spot; acier, nickel mat

L 485, B 65



GU10



3x 2,8W



3x
250lm



9 002759 925956



Ø 60



9 002759 925963



L 285

B 65



9 002759 925970



L 485

B 65



92598

LED



92599

LED

92598 BUZZ-LED

spot; steel, satin nickel
Spot; Stahl, nickel-matt
spot; acier, nickel mat

L 685, B 65



GU10



4x 2,8W



4x
warm
WHITE
250lm



9 002759 925987



92599 BUZZ-LED

spot; steel, satin nickel
Spot; Stahl, nickel-matt
spot; acier, nickel mat

L 1050, B 65



GU10



6x 2,8W



6x
warm
WHITE
250lm



9 002759 925994

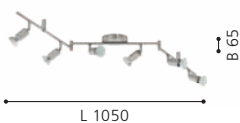



32428

LED



32429

LED



32431

LED

32428 BUZZ-LED

spot; steel, black
Spot; Stahl, schwarz
spot; acier, noir

Ø 60



GU10



1x 2,8W



1x
250lm

32429 BUZZ-LED

spot; steel, black
Spot; Stahl, schwarz
spot; acier, noir

L 285, B 65



GU10



2x 2,8W



2x
250lm

32431 BUZZ-LED

spot; steel, black
Spot; Stahl, schwarz
spot; acier, noir

L 485, B 65



GU10



3x 2,8W



3x
250lm



9 002759 324285



Ø 60



9 002759 324292



L 285

B 65



9 002759 324315



L 485

B 65



32432

LED



32433

LED

32432 BUZZ-LED

spot; steel, black
Spot; Stahl, schwarz
spot; acier, noir

L 685, B 65



GU10



4x 2,8W



4x
warm
WHITE
250lm



9 002759 324322



L 685

32433 BUZZ-LED

spot; steel, black
Spot; Stahl, schwarz
spot; acier, noir

L 1050, B 65



GU10



6x 2,8W



6x
warm
WHITE
250lm



9 002759 324339



L 1050



33184

LED



33185

LED



33186

LED

33184 BUZZ-LED

spot; steel, brushed brass
Spot; Stahl, messing-gebürstet
spot; acier, laiton brossé

Ø 60



GU10



1x 2,8W



1x
warm
WHITE
250lm



9 002759 331849



Ø 60

33185 BUZZ-LED

spot; steel, brushed brass
Spot; Stahl, messing-gebürstet
spot; acier, laiton brossé

L 285, B 65



GU10



2x 2,8W



2x
warm
WHITE
250lm



9 002759 331856



L 285

B 65

33186 BUZZ-LED

spot; steel, brushed brass
Spot; Stahl, messing-gebürstet
spot; acier, laiton brossé

L 485, B 65



GU10



3x 2,8W



3x
warm
WHITE
250lm



9 002759 331863



L 485

B 65



33187

LED

33187 BUZZ-LED

spot; steel, brushed brass
Spot; Stahl, messing-gebürstet
spot; acier, laiton brossé

L 685, B 65



GU10



4x 2,8W



warm
WHITE
4x
250lm



9 002759 331870

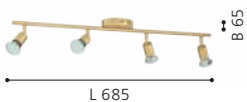



92642

LED



92641

LED



92643

LED

92641 MAGNUM-LED

spot; steel, satin nickel, chrome
Spot; Stahl, nickel-matt, chrom
spot; acier, nickel mat, chrome

Ø 70

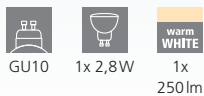

92642 MAGNUM-LED

spot; steel, satin nickel, chrome
Spot; Stahl, nickel-matt, chrom
spot; acier, nickel mat, chrome

L 330, B 105

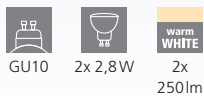

92643 MAGNUM-LED

spot; steel, satin nickel, chrome
Spot; Stahl, nickel-matt, chrom
spot; acier, nickel mat, chrome

L 255, H 295

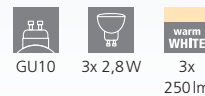



95824

LED



92644

LED



92645

LED

95824 MAGNUM LED

spot; steel, satin nickel, chrome
Spot; Stahl, nickel-matt, chrom
spot; acier, nickel mat, chrome

Ø 180



GU10



3x 2,8W



warm
WHITE

3x
250lm



9 002759 958244



Ø 180

92644 MAGNUM-LED

spot; steel, satin nickel, chrome
Spot; Stahl, nickel-matt, chrom
spot; acier, nickel mat, chrome

L 645, B 105



GU10



4x 2,8W



warm
WHITE

4x
250lm



9 002759 926441



L 645

B 105

92645 MAGNUM-LED

spot; steel, satin nickel, chrome
Spot; Stahl, nickel-matt, chrom
spot; acier, nickel mat, chrome

L 1050



GU10



6x 2,8W



warm
WHITE

6x
250lm



9 002759 926458



L 1050



93359

LED



93085

LED



93358

93359



94609

93085 CABO 1

wall/ceiling light; steel, chrome / satin glass, white, clear
Wand- / Deckenleuchte; Stahl, chrom / Glas satiniert, weiss, klar
Applique/Plafonnier; acier, chrome / verre satiné, blanc, transparent

H 100, Ø 290



GU10



4x 2,8W



4x
250lm

93359 VILANOVA

system; aluminium, steel, aluminium, chrome
System; Alu, Stahl, alu, chrom
système; aluminium, acier, aluminium, chrome

L 2000, H 200



GU10



5x 2,8W



5x
250lm

94609 VILANOVA

accessory; steel, satin nickel
Zubehör; Stahl, nickel-matt
Accessoires; acier, nickel mat

L 395



9 002759 930851

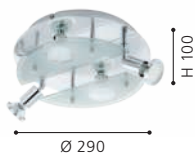

9 002759 933593



9 002759 946098

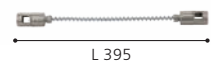



93358

LED

93358 VILANOVA

system; aluminium, steel, aluminium, chrome / glass, white, clear
 System; Alu, Stahl, alu, chrom / Glas, weiss, klar
 système; aluminium, acier, aluminium, chrome / verre, blanc, transparent

L 2000, H 200



GU10



5x 4,6W



5x
 warm
 WHITE
 400lm



9 002759 933586



INCL.



L 2000

94609

Set to connect 93359 and 93358 tracks:
 > 250mm Kabel
 > 2 end parts
 > 1 straight connector for direct connection

Verbindungsset für 93359 und 93358 Schienen:
 > 250mm Kabel
 > 2 Endstücke
 > 1 Verbinder für eine direkte Verbindung

Set de connexion pour rails 93359 et 93358:
 > câble de 250mm
 > 2 pièces d'about
 > 1 connecteur pour une connexion directe

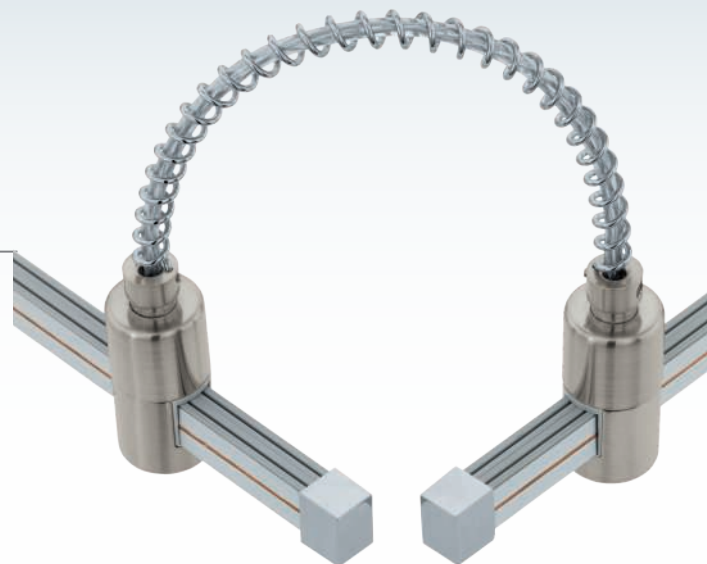



96182

LED



96178

LED



96179

LED

96182 CARDILLIO 1

spot; aluminium, steel, aluminium, chrome / plastic, satin finish
Spot; Alu, Stahl, alu, chrom / Kunststoff, satiniert
spot; aluminium, acier, aluminium, chrome / plastique, satiné

L 985, B 85

LED

warm WHITE

LED

warm WHITE



4x 3,2W

1760lm

2x 3,3W

800lm



96178 CARDILLIO 1

spot; aluminium, steel, aluminium, chrome / plastic, satin finish
Spot; Alu, Stahl, alu, chrom / Kunststoff, satiniert
spot; aluminium, acier, aluminium, chrome / plastique, satiné

L 225, B 65

LED

warm WHITE

LED

warm WHITE



1x 3,2W

440lm

1x 2,2W

260lm



96179 CARDILLIO 1

spot; aluminium, steel, aluminium, chrome / plastic, satin finish
Spot; Alu, Stahl, alu, chrom / Kunststoff, satiniert
spot; aluminium, acier, aluminium, chrome / plastique, satiné

L 390, B 85

LED

warm WHITE

LED

warm WHITE



2x 3,2W

880lm

1x 3,3W

400lm

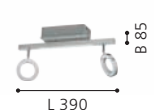



96181

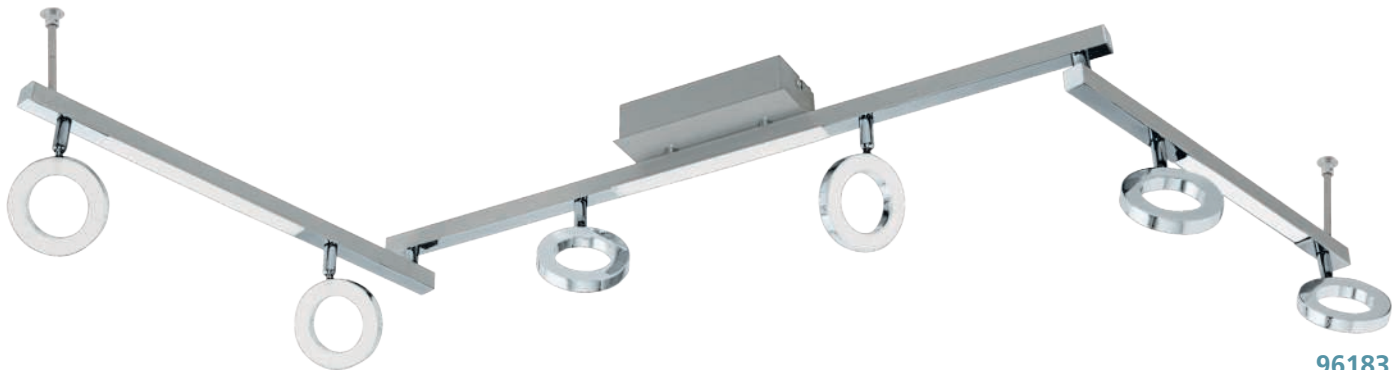

96183



96181 CARDILLIO 1

spot; aluminium, steel, aluminium, chrome / plastic, satin finish
 Spot; Alu, Stahl, alu, chrom / Kunststoff, satiniert
 spot; aluminium, acier, aluminium, chrome / plastique, satiné

L 690, B 85



9 002759 961817

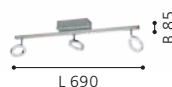

96183 CARDILLIO 1

spot; aluminium, steel, aluminium, chrome / plastic, satin finish
 Spot; Alu, Stahl, alu, chrom / Kunststoff, satiniert
 spot; aluminium, acier, aluminium, chrome / plastique, satiné

L 1585, B 85



9 002759 961831

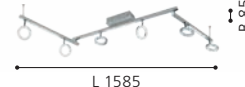

CARDILLIO 1

These luminaires have different lighting sources. Profil lights combined with spot heads create basic lighting as well as accent lighting.

Diese Leuchten verfügen über unterschiedliche Lichtquellen. Profilleuchten kombiniert mit Spotköpfen schaffen sowohl Grundlicht als auch Akzentbeleuchtung.

Ces luminaires ont des sources d'éclairage différentes. La combinaison entre un éclairage sur la base du produit et un spot vous permet d'avoir un éclairage général mais aussi directionnel.



900516

LED



900513

LED

900516 CARDILLO 2

spot; aluminium, steel, black / plastic, satin finish
Spot; Alu, Stahl, schwarz / Kunststoff, satiniert
spot; aluminium, acier, noir / plastique, satiné

L 985, B 85, H 175

LED warm WHITE LED warm WHITE

4x 3,2W 1600lm 2x 3,3W 720lm



9 008606 244454



L 985

900513 CARDILLO 2

spot; aluminium, steel, black / plastic, satin finish
Spot; Alu, Stahl, schwarz / Kunststoff, satiniert
spot; aluminium, acier, noir / plastique, satiné

L 225, B 65, H 165

LED warm WHITE LED warm WHITE

1x 3,2W 400lm 1x 2,2W 240lm



9 008606 244423



L 225



900514 CARDILLIO 2

spot; aluminium, steel, black / plastic, satin finish
Spot; Alu, Stahl, schwarz / Kunststoff, satiniert
spot; aluminium, acier, noir / plastique, satiné

L 385, B 85, H 175



900515 CARDILLIO 2

spot; aluminium, steel, black / plastic, satin finish
Spot; Alu, Stahl, schwarz / Kunststoff, satiniert
spot; aluminium, acier, noir / plastique, satiné

L 385, B 85, H 175



900839 CARDILLIO 1

spot; aluminium, steel, black / plastic, satin finish
Spot; Alu, Stahl, schwarz / Kunststoff, satiniert
spot; aluminium, acier, noir / plastique, satiné

L 1585, B 85, H 200

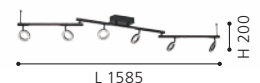



95629

LED



DESIGN
HIGHLIGHT
DETAIL

95629 SALTO

spot; steel, chrome / plastic, satin finish
Spot; Stahl, chrom / Kunststoff, satiniert
spot; acier, chrome / plastique, satiné

L 360, B 120

LED

2x 5,4W

warm
WHITE

2x
640lm



9 002759 956295



L 360

B 120



95631



95632



95631 SALTO

spot; steel, chrome / plastic, satin finish
 Spot; Stahl, chrom / Kunststoff, satiniert
 spot; acier, chrome / plastique, satiné

L 560, B 130



3x 5,4W

3x
640lm

95632 SALTO

spot; steel, chrome / plastic, satin finish
 Spot; Stahl, chrom / Kunststoff, satiniert
 spot; acier, chrome / plastique, satiné

L 760, B 130

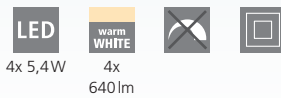

4x 5,4W

4x
640lm



9 002759 956318



9 002759 956325





CLIP & PLUG LUMINAIRES

KLEMM- & STECKERLEUCHTEN
LUMINAIRES À PINCE & SUR PRISE



EN LIGHT - VIRTUALLY ANYWHERE

Our clamping and plug-in luminaires inspire with their flexible uses. They serve as pleasant reading lamps or can be positioned for targeted highlighting.

DE LICHT - PRAKTISCH ÜBERALL

Unsere Klemm- und Steckerleuchten begeistern durch ihre flexible Verwendbarkeit. Sie dienen als angenehme Lesebeleuchtung oder können zur gezielten Lichtsetzung positioniert werden.

FR LA LUMIÈRE - PRATIQUE ET PARTOUT

Nos luminaires à pinces et à fiches ravissent de leurs possibilités flexibles d'utilisation. Ils servent de lumière agréable pour la lecture ou peuvent être positionnés afin d'offrir une lumière ciblée.





OVERVIEW

CLIP & PLUG LUMINAIRES
KLEMM- & STECKERLEUCHTEN
LUMINAIRES À PINCE & SUR PRISE



CABADO
776



FABIO
776-777



RICCIO 1
777



MINI 4
778-779



DAKAR 3
778



This product is available in different colors and shapes. / Dieser Artikel ist in unterschiedlichen Farben und Formen verfügbar. /
Cet article est disponible en différentes couleurs et formes.





97077

LED



81262

97077 CABADO

clamp light; plastic, white
Klemmleuchte; Kunststoff, weiss
luminaire à pince; plastique, blanc

L 120, B 65, H 420



1,6W



150lm



Li-ion



500mAh



9 002759 970772



L 120

81262 FABIO

clamp light; steel, plastic, white, silver
Klemmleuchte; Stahl, Kunststoff, weiss, silber
luminaire à pince; acier, plastique, blanc, argent

H 300



E14



1x 40W



9 002759 812621



H 300



81265



94329

LED

81265 FABIO

clamp light; steel, plastic, silver
 Klemmleuchte; Stahl, Kunststoff, silber
 luminaire à pince; acier, plastique, argent

H 300



E14 1x 40W



9 002759 812652



H 300

94329 RICCIO 1

clamp light; plastic, steel, white, chrome / steel, white, chrome
 Klemmleuchte; Kunststoff, Stahl, weiss, chrom / Stahl, weiss, chrom
 luminaire à pince; plastique, acier, blanc, chrome / acier, blanc, chrome

L 180, H 330

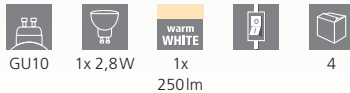

GU10 1x 2,8W 1x 250lm 4



9 002759 943295

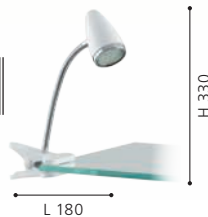

H 330

L 180



92924

LED



92925

LED



92935

92925 MINI 4

plug-in light; steel, white, chrome
Steckerleuchte; Stahl, weiss, chrom
luminaire sur prise; acier, blanc, chrome

L 70, H 100

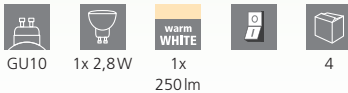

92924 MINI 4

plug-in light; steel, satin nickel, chrome
Steckerleuchte; Stahl, nickel-matt, chrom
luminaire sur prise; acier, nickel mat, chrome

L 70, H 100

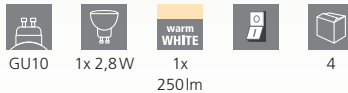

92935 DAKAR 3

plug-in light; steel, satin nickel, chrome / plastic, white
Steckerleuchte; Stahl, nickel-matt, chrom / Kunststoff, weiss
luminaire sur prise; acier, nickel mat, chrome / plastique, blanc

L 70, H 180, A 280





92933

LED

92933 MINI 4

plug-in light; steel, satin nickel, chrome
Steckerleuchte; Stahl, nickel-matt, chrom
luminaire sur prise; acier, nickel mat, chrome

L 70, H 180, A 220



GU10



1x 2,8W



warm
WHITE
1x
250lm



4



9 002759 929336





TABLE & FLOOR LUMINAIRES

TISCH- & STEHLEUCHTEN
LUMINAIRES DE TABLE & LAMPADAIRES

EN WE LOVE LIGHT

The range of table and floor luminaires is made up of many different styles and convinces with its diverse uses. The luminaires give your home a comfortable light mood and turn into chic living room accessories.

DE WIR STEHEN AUF LICHT

Das Sortiment der Tisch- und Stehleuchten setzt sich aus unterschiedlichen Stilen zusammen und überzeugt mit seinen vielseitigen Einsatzmöglichkeiten. Die Leuchten verleihen Ihrem Zuhause eine gemütliche Lichtstimmung und werden zum schicken Wohnraumaccessoire.

FR NOUS NOUS TENONS EN PLEINE LUMIÈRE



















































La gamme de luminaires de table et lampadaires est formée de différents styles et persuade par ses multiples possibilités d'application. Les lampes donnent à votre intérieur une lumière conviviale et se transforment en des accessoires d'habitat chics.





OVERVIEW

TABLE & FLOOR LUMINAIRES
TISCH- & STEHLEUCHTEN
LUMINAIRES DE TABLE & LAMPADAIRES

 PICCOLA 785	 MANNERA 786-787	 FONDACHELLI 788	 CONESA 790	 ESPARTAL 791	 NADINA 791	 ONEDA 792	 CORTADERAS 792
 ARANZOLA 793	 RONDO 4 794	 BELESER 795	 BUDENSEA 796	 CARBONERAS 796	 PICACHA 799	 BORGILLIO 799	 UP 2 800-801
 BAYA LED 802-803	 BAYA 804	 PASTERI 806	 CARLTON 2 807	 MANALBA 1 808	 MANALBA 808	 CHIETINO 1 809	 BELLARIVA 3 809
 TRONDIO 809	 BELLARIVA 810	 CAPALBIO 811	 CAHUAMA 812	 BATISTA 3 813	 TURALDO 1 813	 SWARBY 813	 MURNIA 814
 PETTO 1 814	 BILBANA 815	 BATABANO 815	 ERMUA 815	 SARONA 816	 AMEZAGA 816	 MARYVILLA 817	 CAPRAROLA 817
 CIUDADELA 817	 MADONNINA 818	 SOLO 2 819	 SOLO 1 820	 SOLO 821	 DAMASCO 1 821-822	 SLIM 821	 GEO 823
 NARANJO 825	 DESIERTO 825						



This product is available in different colors and shapes. / Dieser Artikel ist in unterschiedlichen Farben und Formen verfügbar. / Cet article est disponible en différentes couleurs et formes.



Office table & floor luminaires starts on page 826.
Office Tisch- & Stehleuchten starten auf Seite 826.
Luminaires de table & lampadaires à bureau commence à la page 826.





900923

LED

HIGH
IP

IP54



900924



900925



900923 PICCOLA

table light; steel, brushed brass / plastic, white
Tischleuchte; Stahl, messing-gebürstet / Kunststoff, weiss
luminaire de table; acier, laiton brossé / plastique, blanc

H 280, Ø 130, Base: Ø 70

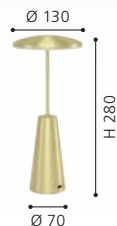
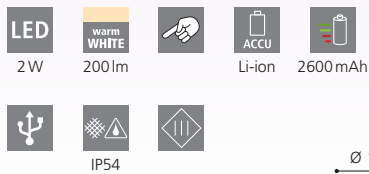

900924 PICCOLA

table light; steel, dark bronze / plastic, white
Tischleuchte; Stahl, bronze dunkel / Kunststoff, weiss
luminaire de table; acier, bronze foncé / plastique, blanc

H 280, Ø 130, Base: Ø 70



900925 PICCOLA

table light; steel, black / plastic, white
Tischleuchte; Stahl, schwarz / Kunststoff, weiss
luminaire de table; acier, noir / plastique, blanc

H 280, Ø 130, Base: Ø 70

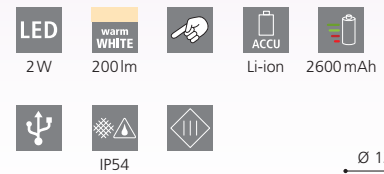



900459



IP54



900457



IP54

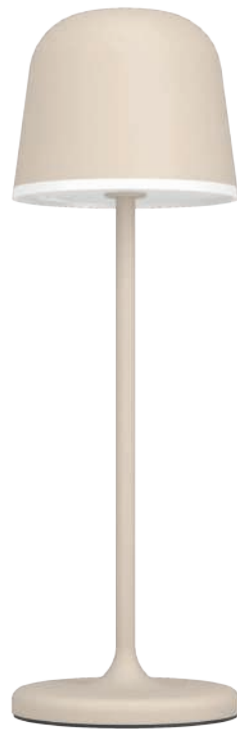

900461



IP54

900459 MANNERA

table light; aluminium, steel, auburn / plastic, white
Tischleuchte; Alu, Stahl, rostbraun / Kunststoff, weiss
luminaire de table; aluminium, acier, brun rouille / plastique, blanc

H 340, Ø 110, Base: Ø 110

LED 2,2W warm WHITE 200lm ACCU Li-ion 1800mAh



900457 MANNERA

table light; aluminium, steel, black / plastic, white
Tischleuchte; Alu, Stahl, schwarz / Kunststoff, weiss
luminaire de table; aluminium, acier, noir / plastique, blanc

H 340, Ø 110, Base: Ø 110

LED 2,2W warm WHITE 200lm ACCU Li-ion 1800mAh



900461 MANNERA

table light; aluminium, steel, sandy / plastic, white
Tischleuchte; Alu, Stahl, sandfarben / Kunststoff, weiss
luminaire de table; aluminium, acier, couleur sable / plastique, blanc

H 340, Ø 110, Base: Ø 110

LED 2,2W warm WHITE 200lm ACCU Li-ion 1800mAh





900458



900458 MANNERA

table light; aluminium, steel, grey / plastic, white
 Tischleuchte; Alu, Stahl, grau / Kunststoff, weiss
 luminaire de table; aluminium, acier, gris / plastique, blanc

H 340, Ø 110, Base: Ø 110



2,2W



200lm



Li-ion



1800 mAh



IP54



9 008606 243976





95539



95541

95539 FONDACHELLI

floor light; steel, satin nickel / fabric, white, silver
 Stehleuchte; Stahl, nickel-matt / Textil, weiss, silber
 lampadaire; acier, nickel mat / tissu, blanc, argent

H 1515, Ø 510



E27 1x 60W



9 002759 955397

95541 FONDACHELLI

floor light; steel, black / fabric, black, copper
 Stehleuchte; Stahl, schwarz / Textil, schwarz, kupfer
 lampadaire; acier, noir / tissu, noir, cuivre

H 1515, Ø 510

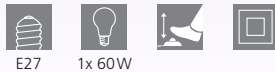

E27 1x 60W



9 002759 955410

900187 FONDACHELLI

floor light; steel, black / fabric, linen, grey
 Stehleuchte; Stahl, schwarz / Textil, Leinen, grau
 lampadaire; acier, noir / tissu, lin, gris

H 1515, Ø 510

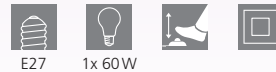

E27 1x 60W



9 008606 234479



900187



95686



98309

LED

95686 CONESA

floor light; steel, satin nickel / fabric, glass, white
 Stehleuchte; Stahl, nickel-matt / Textil, Glas, weiss
 lampadaire; acier, nickel mat / tissu, verre, blanc

H 1700, Ø 380, Base: Ø 230



E27



1x 60W



E14



1x 40W



9 002759 956868

Ø 380



H 1700

Ø 230



92206



98309 ESPARTAL

floor light; steel, aluminium, satin nickel, aluminium / fabric, white

Stehleuchte; Stahl, Alu, nickel-matt, alu / Textil, weiss

lampadaire; acier, aluminium, nickel mat, aluminium / tissu, blanc

H 1485, Ø 250, Base: Ø 250



E27 1x 60W 11,8W 1650lm



9 002759 983093



92206 NADINA

floor light; steel, satin nickel / textile with velcro, white

Stehleuchte; Stahl, nickel-matt / Textil mit Klettverschluss, weiss

lampadaire; acier, nickel mat / tissu avec fermeture velcro, blanc

L 1790, B 380, H 1950, Base: Ø 320

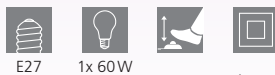

E27 1x 60W



9 002759 922061





900393



900394



97806

LED

900393 ONEDA

table light; steel, black, white
Tischleuchte; Stahl, schwarz, weiss
luminaire de table; acier, noir, blanc

L 290, B 145, H 445, Base: Ø 210



900394 ONEDA

floor light; steel, black, white
Stehleuchte; Stahl, schwarz, weiss
lampadaire; acier, noir, blanc

L 540, B 200, H 1605, Base: Ø 315

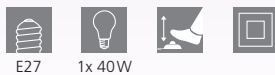

97806 CORTADERAS

floor light; steel, black, gold
Stehleuchte; Stahl, schwarz, gold
lampadaire; acier, noir, or

H 1445, Ø 250, Base: Ø 250

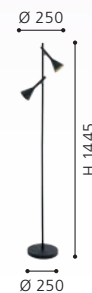



900134



900135

900134 ARANZOLA

table light; steel, black, white
Tischleuchte; Stahl, schwarz, weiss
luminaire de table; acier, noir, blanc

H 450, Ø 300, Base: Ø 115



E27 1x 40W



9 008606 240012



900135 ARANZOLA

floor light; steel, black, white
Stehleuchte; Stahl, schwarz, weiss
lampadaire; acier, noir, blanc

L 300, H 1635, Base: Ø 300



E27 1x 40W



9 008606 240029

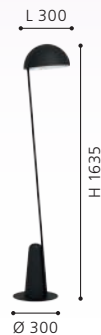



DESIGN
HIGHLIGHT
DETAIL



900868

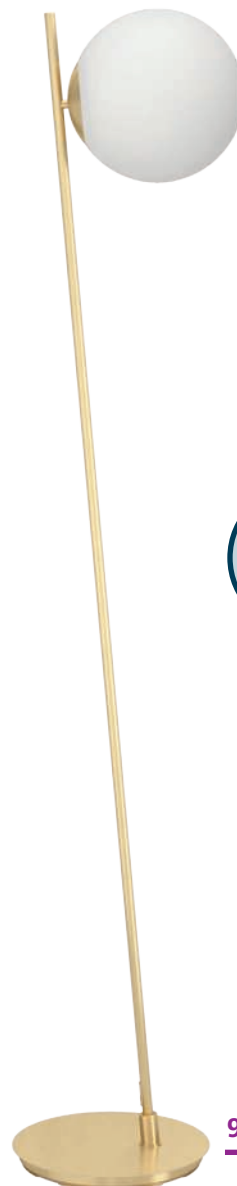

RONDO 4

900868 RONDO 4

table light; steel, brushed brass / matte-opal glass, white
Tischleuchte; Stahl, messing-gebürstet / Glas opal-matt, weiss
luminaire de table; acier, laiton brossé / verre opale mat, blanc

L 230, B 180, H 565, Base: Ø 215



900869 RONDO 4

floor light; steel, brushed brass / matte-opal glass, white
Stehleuchte; Stahl, messing-gebürstet / Glas opal-matt, weiss
lampadaire; acier, laiton brossé / verre opale mat, blanc

L 355, B 250, H 1745, Base: Ø 300





98386



98387



98386 BELESER

table light; steel, black / glass vaporized, black-transparent
Tischleuchte; Stahl, schwarz / Glas bedampft, schwarz-transparent
luminaire de table; acier, noir / verre vaporisé, noir transparent

L 265, B 205, H 505, Base: Ø 200

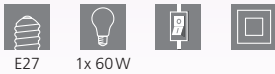

98387 BELESER

floor light; steel, black / glass vaporized, black-transparent
Stehleuchte; Stahl, schwarz / Glas bedampft, schwarz-transparent
lampadaire; acier, noir / verre vaporisé, noir transparent

L 260, B 205, H 1505, Base: Ø 220

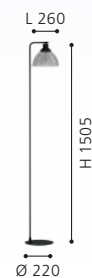
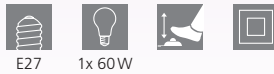



99113

These luminaires are rotatable.
Diese Leuchten sind drehbar.
Ces luminaires sont orientables.

0-180°

0-80°

99113

LED



99822

The heads of this luminaires can be switched and dimmed separately.

Die Köpfe dieser Leuchten sind getrennt voneinander schaltbar und dimmbar.

Les têtes de ce luminaires peuvent être commutées et gradées séparément.

99113 BUDENSEA

floor light; cast aluminium, black, white
Stehleuchte; Aluguss, schwarz, weiss
lampadaire; fonte d'aluminium, noir, blanc

L 365, B 250, H 1800, Base: B 300, T 250



GU10



2x 4,5W



2x
warm
WHITE
345lm



L 365

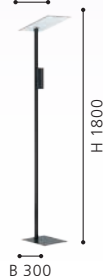

9 002759 991135



INCL.

99822 CARBONERAS

floor light; steel, black / plastic, transparent
Stehleuchte; Stahl, schwarz / Kunststoff, transparent
lampadaire; acier, noir / plastique, transparent

L 400, B 250, H 1800, Base: B 330, T 240



6x 3,8W



2400lm



7W



750lm



L 400

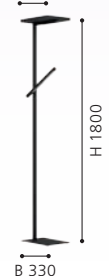

9 002759 998226



99822

LED



99715

LED

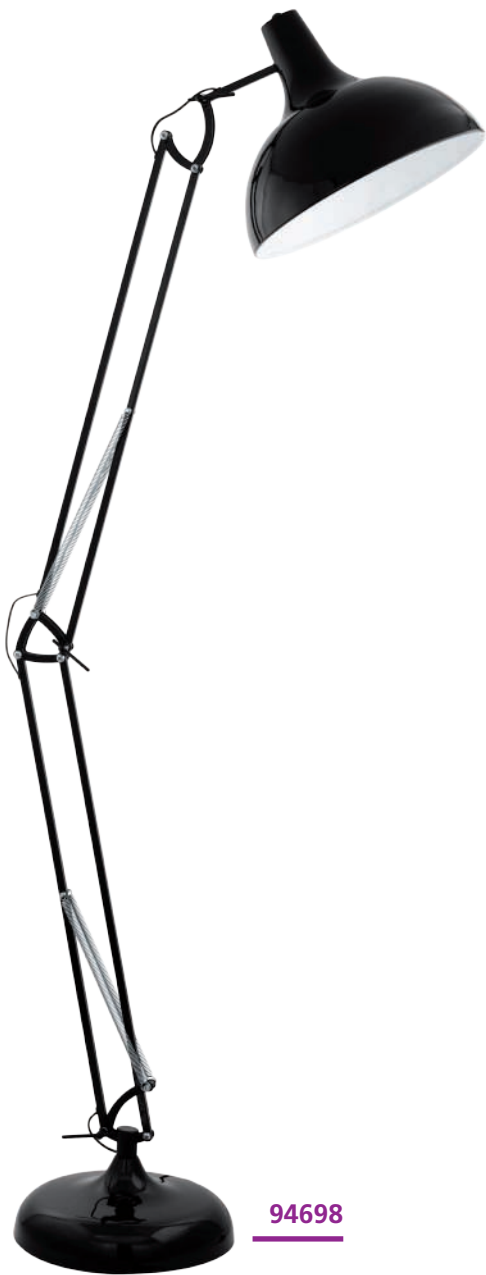

94698

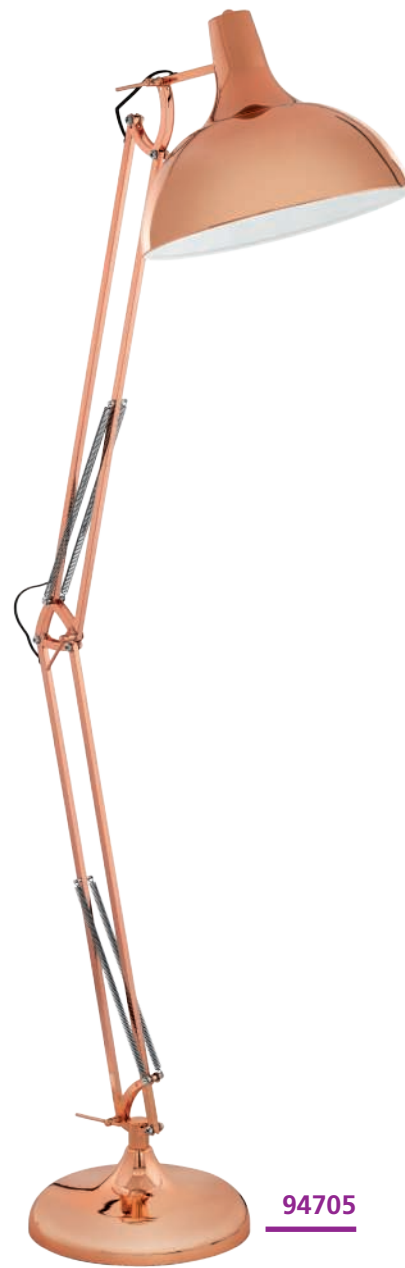

94705

99715 PICACHA

floor light; steel, black / plastic, white
 Stehleuchte; Stahl, schwarz / Kunststoff, weiss
 lampadaire; acier, noir / plastique, blanc

H 1625, Base: B 150, T 150



94698 BORGILLIO

floor light; steel, black
 Stehleuchte; Stahl, schwarz
 lampadaire; acier, noir

L 380, H 1900, Base: Ø 340

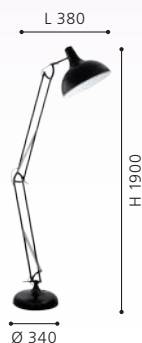

94705 BORGILLIO

floor light; steel, copper
 Stehleuchte; Stahl, kupfer
 lampadaire; acier, cuivre

L 380, H 1900, Base: Ø 340

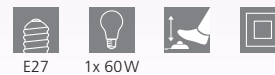



93917



82842



82843

93917 UP 2

floor light; steel, nickel-nero / plastic, glass, white
 Stehleuchte; Stahl, nickel-nero / Kunststoff, Glas, weiss
 lampadaire; acier, nickel noir / plastique, verre, blanc

H 1765, Ø 275, Base: Ø 230

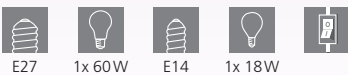

82842 UP 2

floor light; steel, satin nickel / plastic, glass, white
 Stehleuchte; Stahl, nickel-matt / Kunststoff, Glas, weiss
 lampadaire; acier, nickel mat / plastique, verre, blanc

H 1765, Ø 275, Base: Ø 230



82843 UP 2

floor light; steel, matte brass / plastic, glass, white
 Stehleuchte; Stahl, messing-matt / Kunststoff, Glas, weiss
 lampadaire; acier, laiton mat / plastique, verre, blanc

H 1765, Ø 275, Base: Ø 230

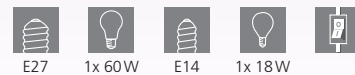



82844

DESIGN
HIGHLIGHT
DETAIL



82844 UP 2

floor light; steel, bronzed / plastic, glass, white
Stehleuchte; Stahl, brüniert / Kunststoff, Glas, weiss
lampadaire; acier, brun / plastique, verre, blanc

H 1765, Ø 275, Base: Ø 230



E27



1x 60W



E14



1x 18W



9 002759 828448





93877



93876



93875



93877 BAYA LED

floor light; steel, brass / glass, plastic, white, satin finish
 Stehleuchte; Stahl, messing / Glas, Kunststoff, weiss, satiniert
 lampadaire; acier, laiton / verre, plastique, blanc, satiné

L 360, H 1800, Base: Ø 250

LED 20W warm WHITE 1950lm LED 2,5W warm WHITE 240lm LED 2,5W

warm WHITE 250lm



9 002759 938772



93876 BAYA LED

floor light; steel, bronzed / glass, plastic, white, satin finish
 Stehleuchte; Stahl, brüniert / Glas, Kunststoff, weiss, satiniert
 lampadaire; acier, brun / verre, plastique, blanc, satiné

L 360, H 1800, Base: Ø 250

LED 20W warm WHITE 1950lm LED 2,5W warm WHITE 240lm LED 2,5W

warm WHITE 250lm



9 002759 938765

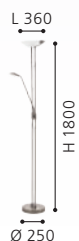

93875 BAYA LED

floor light; steel, chrome / glass, plastic, white, satin finish
 Stehleuchte; Stahl, chrom / Glas, Kunststoff, weiss, satiniert
 lampadaire; acier, chrome / verre, plastique, blanc, satiné

L 360, H 1800, Base: Ø 250

LED 20W warm WHITE 1950lm LED 2,5W warm WHITE 240lm LED 2,5W

warm WHITE 250lm



9 002759 938758

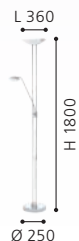



DESIGN
HIGHLIGHT
DETAIL

93874 BAYA LED

floor light; steel, satin nickel / glass, plastic, white, satin finish
Stehleuchte; Stahl, nickel-matt / Glas, Kunststoff, weiss, satiniert
lampadaire; acier, nickel mat / verre, plastique, blanc, satiné

L 360, H 1800, Base: Ø 250

LED 20W	warm WHITE 2200lm	LED 2,5W	warm WHITE 250lm	LED 2,5W
-------------------	-----------------------------	--------------------	----------------------------	--------------------

warm WHITE 250lm				
----------------------------	--	--	--	--



9 002759 938741

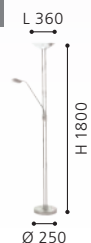

93874

LED



DESIGN
HIGHLIGHT
DETAIL



85974

85974 BAYA

floor light; steel, bronzed / satin glass, white
Stehleuchte; Stahl, brüniert / Glas satiniert, weiss
lampadaire; acier, brun / verre satiné, blanc

L 440, H 1800, Base: Ø 280



R7S 1x 230W G9 1x 33W



9 002759 859749



85971 BAYA

floor light; steel, satin nickel / satin glass, white
Stehleuchte; Stahl, nickel-matt / Glas satiniert, weiss
lampadaire; acier, nickel mat / verre satiné, blanc

L 440, H 1800, Base: Ø 280



R7S 1x 230W G9 1x 33W



9 002759 859718

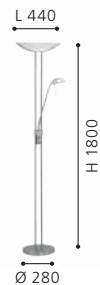



85971



95726



95725

95726 PASTERI

table light; steel, satin nickel / fabric, taupe
Tischleuchte; Stahl, nickel-matt / Textil, taupe
luminaire de table; acier, nickel mat / tissu, taupe

H 275, Ø 140, Base: Ø 120



E14 1x 40W



95725 PASTERI

table light; steel, satin nickel / fabric, white
Tischleuchte; Stahl, nickel-matt / Textil, weiss
luminaire de table; acier, nickel mat / tissu, blanc

H 275, Ø 140, Base: Ø 120



E14 1x 40W





95789



95787



95788

95789 CARLTON 2

table light; steel, black / fabric, white
Tischleuchte; Stahl, schwarz / Textil, weiss
luminaire de table; acier, noir / tissu, blanc

H 305, Ø 165, Base: Ø 95

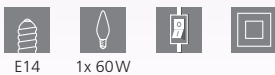

E14 1x 60W



9 002759 957896



95787 CARLTON 2

table light; steel, copper / fabric, black, copper
Tischleuchte; Stahl, kupfer / Textil, schwarz, kupfer
luminaire de table; acier, cuivre / tissu, noir, cuivre

H 305, Ø 165, Base: Ø 95



E14 1x 60W



9 002759 957872



95788 CARLTON 2

table light; steel, brass / fabric, black, gold
Tischleuchte; Stahl, messing / Textil, schwarz, gold
luminaire de table; acier, laiton / tissu, noir, or

H 305, Ø 165, Base: Ø 95



E14 1x 60W



9 002759 957889





99329



99331



95386

99329 MANALBA 1

table light; ceramic, silver / fabric, white, silver
Tischleuchte; Keramik, silber / Textil, weiss, silber
luminaire de table; céramique, argent / tissu, blanc, argent

H 300, Ø 200, Base: Ø 125



E14 1x 40W



9 002759 993290



99331 MANALBA 1

table light; ceramic, gold-coloured / fabric, black, gold
Tischleuchte; Keramik, goldfarben / Textil, schwarz, gold
luminaire de table; céramique, or / tissu, noir, or

H 300, Ø 200, Base: Ø 125

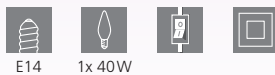

E14 1x 40W



9 002759 993313



95386 MANALBA

table light; steel, gold / fabric, black, gold
Tischleuchte; Stahl, gold / Textil, schwarz, gold
luminaire de table; acier, or / tissu, noir, or

H 380, Ø 250, Base: Ø 160

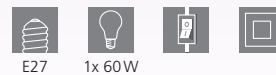

E27 1x 60W



9 002759 953867





97516



99332



93046

97516 CHIETINO 1

table light; wood, steel, natural, chrome / fabric, white
Tischleuchte; Holz, Stahl, natur, chrom / Textil, weiss
luminaire de table; bois, acier, naturel, chrome / tissu, blanc

H 440, Ø 260, Base: B 235, T 235

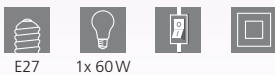

E27 1x 60W



9 002759 975166



99332 BELLARIVA 3

table light; ceramic, white / fabric, linen, light brown
Tischleuchte; Keramik, weiss / Textil, Leinen, hellbraun
luminaire de table; céramique, blanc / tissu, lin, marron transparent

H 360, Ø 200, Base: Ø 160

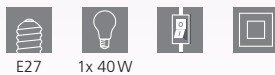

E27 1x 40W



9 002759 993320



93046 TRONDIO

table light; ceramic, white / fabric, white
Tischleuchte; Keramik, weiss / Textil, weiss
luminaire de table; céramique, blanc / tissu, blanc

H 270, Ø 150, Base: Ø 120



E14 1x 40W



9 002759 930462





97774



97773



DESIGN
HIGHLIGHT
DETAIL

97774 BELLARIVA

table light; ceramic, grey / fabric, white
Tischleuchte; Keramik, grau / Textil, weiss
luminaire de table; céramique, gris / tissu, blanc

H 320, Ø 150, Base: Ø 120



97773 BELLARIVA

table light; ceramic, cream-white / fabric, white
Tischleuchte; Keramik, creme-weiss / Textil, weiss
luminaire de table; céramique, blanc crème / tissu, blanc

H 320, Ø 150, Base: Ø 120





CAPALBIO



900824



900823

900824 CAPALBIO

table light; ceramic, grey / fabric, linen, natural
Tischleuchte; Keramik, grau / Textil, Leinen, natur
luminaire de table; céramique, gris / tissu, lin, nature

H 410, Ø 230, Base: Ø 120



E27 1x 40W



9 008606 274017



900823 CAPALBIO

table light; ceramic, sandy / fabric, white
Tischleuchte; Keramik, sandfarben / Textil, weiss
luminaire de table; céramique, couleur sable / tissu, blanc

H 410, Ø 230, Base: Ø 120



E27 1x 40W



9 008606 274000





99824



99825

99824 CAHUAMA

table light; ceramic, light brown / glass, white
Tischleuchte; Keramik, hellbraun / Glas, weiss
luminaire de table; céramique, marron clair / verre, blanc

H 300, Ø 275, Base: Ø 105



E27 1x 40W



99825 CAHUAMA

table light; ceramic, white, black / satin glass, grey matt
Tischleuchte; Keramik, weiss, schwarz / Glas satiniert, grau matt
luminaire de table; céramique, blanc, noir / verre satiné, gris mat

H 300, Ø 275, Base: Ø 105



E27 1x 40W





97589



97589



900334



98859

97589 BATISTA 3

table light; steel, satin nickel / glass wiping technique, white
Tischleuchte; Stahl, nickel-matt / Glas Wischtechnik, weiss
luminaire de table; acier, nickel mat / technique de verre essuyé, blanc

H 225, Ø 120, Base: Ø 110



900334 TURIALDO 1

table light; wood, steel, black
Tischleuchte; Holz, Stahl, schwarz
luminaire de table; bois, acier, noir

H 100, Ø 85



98859 SWARBY

table light; cement, grey
Tischleuchte; Zement, grau
luminaire de table; ciment, gris

H 120, Ø 100

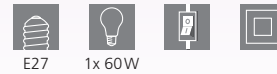



900314



94513

LED

DESIGN
HIGHLIGHT
DETAIL



900314 MURNIA

table light; steel, black, white
Tischleuchte; Stahl, schwarz, weiss
luminaire de table; acier, noir, blanc

L 190, B 165, H 430, Base: Ø 165



94513 PETTO 1

table light; steel, white
Tischleuchte; Stahl, weiss
luminaire de table; acier, blanc

H 135, Ø 105, Base: Ø 90

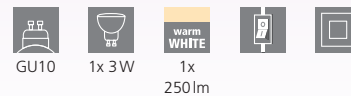



900358



900396



98837



900358 BILBANA

table light; steel, black / matte-opal glass, white
Tischleuchte; Stahl, schwarz / Glas opal-matt, weiss
luminaire de table; acier, noir / verre opale mat, blanc

L 145, B 135, H 195, Base: B 135, T 115



E14 1x 40W



9 008606 241071



900396 BATABANO

table light; steel, sandy, black
Tischleuchte; Stahl, sandfarben, schwarz
luminaire de table; acier, couleur sable, noir

H 275, Ø 180, Base: Ø 160

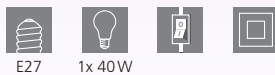

E27 1x 40W



9 008606 243730



98837 ERMUA

table light; steel, wood, black, brown / plastic, white
Tischleuchte; Stahl, Holz, schwarz, braun / Kunststoff, weiss
luminaire de table; acier, bois, noir, marron / plastique, blanc

L 330, B 165, H 505, Base: B 240, T 160



LED warm WHITE 4,5W 480lm



9 002759 988371





900403

LED



98864

900403 SARONA

table light; steel, black, gold
Tischleuchte; Stahl, schwarz, gold
luminaire de table; acier, noir, or

H 315, Ø 140, Base: B 140



GU10



1x 4,5W



1x
warm
WHITE
345lm



9 008606 243785



INCL.



98864 AMEZAGA

table light; steel, black, brass
Tischleuchte; Stahl, schwarz, messing
luminaire de table; acier, noir, laiton

L 355, B 160, H 575, Base: Ø 170



E27



1x 10W



9 002759 988647





900814

The shade colours of these luminaires look very different when switched on and off.

Die Schirmfarben dieser Leuchten sehen im ein- und ausgeschalteten Zustand sehr unterschiedlich aus.

Les couleurs de la teinte de ces luminaires sont très différentes lorsqu'ils sont allumés et éteints.



900552



900814



900898

900552 MARYVILLA

table light; steel, bronzed / glass vaporized, clear, gold
Tischleuchte; Stahl, brüniert / Glas bedampft, klar, gold
luminaire de table; acier, brun / verre vaporisé, transparent, or

H 230, Ø 170, Base: Ø 130



E27 1x 40W



9 008606 244577



900814 CAPRAROLA

table light; steel, brushed brass / satin glass, sandy
Tischleuchte; Stahl, messing-gebürstet / Glas satiniert, sandfarben
luminaire de table; acier, laiton brossé / verre satiné, couleur sable

H 460, Ø 200, Base: Ø 155



E27 1x 40W



9 008606 274345



900898 CIUADELA

table light; steel, black / steel, fabric, brushed brass, white
Tischleuchte; Stahl, schwarz / Stahl, Textil, messing-gebürstet, weiss
luminaire de table; acier, noir / acier, tissu, laiton brossé, blanc

L 230, B 180, H 500, Base: Ø 170

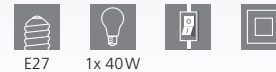

E27 1x 40W



9 008606 274697





900945



900946



DESIGN
HIGHLIGHT
DETAIL

900945 MADONNINA

table light; steel, black / glass vaporized, grey
Tischleuchte; Stahl, schwarz / Glas bedampft, grau
luminaire de table; acier, noir / verre vaporisé, gris

H 270, Ø 330, Base: Ø 150



E27 1x 40W



9 008606 274963



900946 MADONNINA

table light; steel, black / glass vaporized, grey
Tischleuchte; Stahl, schwarz / Glas bedampft, grau
luminaire de table; acier, noir / verre vaporisé, gris

H 325, Ø 250, Base: Ø 130



E27 1x 40W



9 008606 274970





900141



900142

900141 SOLO 2

table light; steel, black / glass vaporized, black-transparent
Tischleuchte; Stahl, schwarz / Glas bedampft, schwarz-transparent
luminaire de table; acier, noir / verre vaporisé, noir transparent

H 415, Ø 260, Base: Ø 180



E27 1x 40W



9 008606 235346



900142 SOLO 2

table light; steel, black / etched glass, white
Tischleuchte; Stahl, schwarz / Glas geätzt, weiss
luminaire de table; acier, noir / verre gravé, blanc

H 415, Ø 260, Base: Ø 180



E27 1x 40W



9 008606 235353





87254



87256



85104

87254 SOLO 1

table light; steel, matte brass / satin glass, white
Tischleuchte; Stahl, messing-matt / Glas satiniert, weiss
luminaire de table; acier, laiton mat / verre satiné, blanc

H 350, Ø 260, Base: Ø 130



E14 1x 40W



9 002759 872540



87256 SOLO 1

table light; steel, wood, bronzed, nut / satin glass, white
Tischleuchte; Stahl, Holz, brüniert, Nuss / Glas satiniert, weiss
luminaire de table; acier, bois, brun, noisette / verre satiné, blanc

H 350, Ø 260, Base: Ø 130

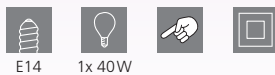

E14 1x 40W



9 002759 872564



85104 SOLO 1

table light; steel, satin nickel / satin glass, white
Tischleuchte; Stahl, nickel-matt / Glas satiniert, weiss
luminaire de table; acier, nickel mat / verre satiné, blanc

H 350, Ø 260, Base: Ø 130

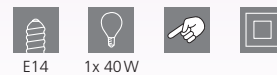

E14 1x 40W



9 002759 851040





91238



95785



95785



82305



82305

91238 SOLO

table light; steel, satin nickel / satin glass, white with decoration
Tischleuchte; Stahl, nickel-matt / Glas satiniert, weiss m. Dekor
luminaire de table; acier, nickel mat / verre satiné, blanc avec décor

H 320, Ø 265, Base: Ø 130

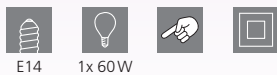

E14 1x 60W



9 002759 912383



95785 DAMASCO 1

table light; steel, satin nickel / matte-opal glass, white
Tischleuchte; Stahl, nickel-matt / Glas opal-matt, weiss
luminaire de table; acier, nickel mat / verre opale mat, blanc

H 300, Ø 145, Base: Ø 120



E14 1x 60W



9 002759 957858



82305 SLIM

table light; steel, satin nickel / glass, white
Tischleuchte; Stahl, nickel-matt / Glas, weiss
luminaire de table; acier, nickel mat / verre, blanc

H 220, Ø 70, Base: Ø 100

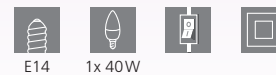

E14 1x 40W



9 002759 823054





81828 | 95775 | 95776



95775



95776



98887

95775 DAMASCO 1

table light; steel, satin nickel / satin glass, white
Tischleuchte; Stahl, nickel-matt / Glas satiniert, weiss
luminaire de table; acier, nickel mat / verre satiné, blanc

H 215, Ø 100

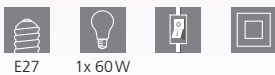

E27 1x 60W



9 002759 957759



95776 DAMASCO 1

table light; steel, chrome / satin glass, white
Tischleuchte; Stahl, chrom / Glas satiniert, weiss
luminaire de table; acier, chrome / verre satiné, blanc

H 215, Ø 100



E27 1x 60W



9 002759 957766



98887 DAMASCO 1

table light; steel, black / glass vaporized, black-transparent
Tischleuchte; Stahl, schwarz / Glas bedampft, schwarz-transparent
luminaire de table; acier, noir / verre vaporisé, noir transparent

H 310, Ø 100



E27 1x 60W



9 002759 988876

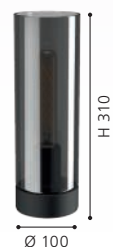



81827 | 91242



81827



81828



91242

81827 GEO

table light; glass, plastic, white
Tischleuchte; Glas, Kunststoff, weiss
luminaire de table; verre, plastique, blanc

H 200, Ø 100, Base: Ø 100

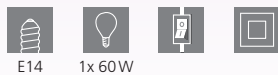

E14 1x 60W



9 002759 818272



81828 GEO

table light; matte-opal glass, white
Tischleuchte; Glas opal-matt, weiss
luminaire de table; verre opale mat, blanc

H 350, Ø 120, Base: Ø 120

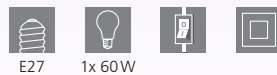

E27 1x 60W



9 002759 818289



91242 GEO

table light; glass, plastic, white
Tischleuchte; Glas, Kunststoff, weiss
luminaire de table; verre, plastique, blanc

H 200, Ø 100

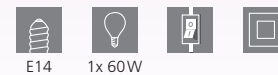

E14 1x 60W



9 002759 912420





99597

LED

DESIGN
HIGHLIGHT
DETAIL



99794



99597 NARANJO

table light; steel, black / glass, clear
Tischleuchte; Stahl, schwarz / Glas, klar
luminaire de table; acier, noir / verre, transparent

L 450, B 430, H 555



4x 4,5W 2200lm



9 002759 995973



99794 DESIERTO

table light; steel, wood, black, brown
Tischleuchte; Stahl, Holz, schwarz, braun
luminaire de table; acier, bois, noir, marron

H 540, Ø 450, Base: Ø 330

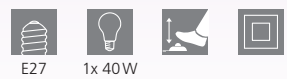

E27 1x 40W



9 002759 997946





OFFICE TABLE & FLOOR LUMINAIRES

OFFICE TISCH- & STEHLEUCHTEN
LUMINAIRES DE TABLE & LAMPADAIRES À BUREAU



EN WE LOVE LIGHT

The range of office table and floor luminaires is made up of many different styles and convinces with its diverse uses.

DE WIR STEHEN AUF LICHT

Das Sortiment der Büro Tisch- und Stehleuchten setzt sich aus unterschiedlichen Stilen zusammen und überzeugt mit seinen vielseitigen Einsatzmöglichkeiten.

FR NOUS NOUS TENONS EN PLEINE LUMIÈRE

La gamme d'éclairages de table et sur pieds à bureau est formée de différents styles et persuade par ses multiples possibilités d'application.





OVERVIEW

OFFICE TABLE & FLOOR LUMINAIRES
OFFICE TISCH- & STEHLEUCHTEN
LUMINAIRES DE TABLE & LAMPADAIRES À BUREAU

 TRUNCA 830	 MASSERIE 830	 ARENAZA 831	 BANDERALO 832	 LACEY-QI 833	 VERADAL-QI 833	 INIESTA 834	 SELLANO 836
 LA SECA 837	 CAUPO 838	 BROLINI 839	 COGNOLI 840	 LAROJA 842-843	 VERADAL 844	 CEPPINO 844-845	 DURENGO 846
 DAMBERA 846	 SNAPORA 846	 GEXO 848	 CABALES 848-849	 CAJERO 850-851	 CABADO 1 851	 TORONA 1 852	 TABILLANO 1 852
 BORGILLO 854-855	 BANKER 856	 FIRMO 857	 BASIC 1 858	 BASIC 858-859	 FOX 860		



This product is available in different colors and shapes. / Dieser Artikel ist in unterschiedlichen Farben und Formen verfügbar. / Cet article est disponible en différentes couleurs et formes.



98093, 98247, 99828, 99829

These luminaires have a Qi charging function. They can wirelessly charge Qi-compatible Smartphones by inductive energy transfer.

Diese Leuchten besitzen eine Qi-Ladefunktion. Damit können Qi-kompatible Smartphones über induktive Energieübertragung kabellos geladen werden.

Ces luminaires disposent d'une fonction de chargement Qi. Cela permet aux smartphones compatibles Qi d'être chargés sans fil par transmission d'énergie inductive.



98093

LED



98247

LED

98093 TRUNCA

table light; plastic, white

Tischleuchte; Kunststoff, weiss

luminaire de table; plastique, blanc

H 485, Base: B 185, T 185



4W



450lm



9 002759 980931



98247 MASSERIE

table light; plastic, white

Tischleuchte; Kunststoff, weiss

luminaire de table; plastique, blanc

H 385, Base: B 165, T 165



3,4W



460lm



9 002759 982478





99828 ARENAZA

table light; steel, plastic, white, black
 Tischleuchte; Stahl, Kunststoff, weiss, schwarz
 luminaire de table; acier, plastique, blanc, noir

L 240, B 130, H 320, Base: B 240, T 120

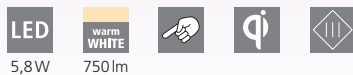

5,8W 750lm



99829 ARENAZA

table light; steel, plastic, black
 Tischleuchte; Stahl, Kunststoff, schwarz
 luminaire de table; acier, plastique, noir

L 240, B 130, H 320, Base: B 240, T 120

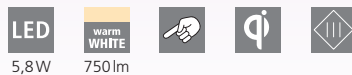

5,8W 750lm





DESIGN
HIGHLIGHT
DETAIL

99831 BANDERALO

table light; plastic, white

Tischleuchte; Kunststoff, weiss

luminaire de table; plastique, blanc

L 305, B 170, H 405, Base: Ø 170

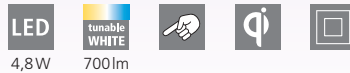

99832 BANDERALO

table light; plastic, black

Tischleuchte; Kunststoff, schwarz

luminaire de table; plastique, noir

L 305, B 170, H 405, Base: Ø 170

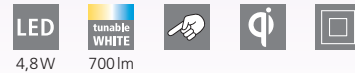



900626 LACEY-QI

table light; steel, wood, black, brown / steel, black, creme
 Tischleuchte; Stahl, Holz, schwarz, braun / Stahl, schwarz, creme
 luminaire de table; acier, bois, noir, marron / acier, noir, crème

L 240, B 135, H 500, Base: B 190, T 130

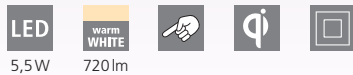

900628 VERADAL-QI

table light; steel, wood, black, brown / steel, black, creme
 Tischleuchte; Stahl, Holz, schwarz, braun / Stahl, schwarz, creme
 luminaire de table; acier, bois, noir, marron / acier, noir, crème

L 215, B 160, H 450, Base: Ø 160

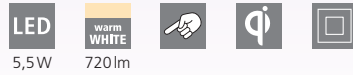



900956

LED



900958

LED



INIESTA

The luminaire arm can be swivelled 180°.

Der Leuchtenarm ist 180° schwenkbar.

Le bras du luminaire peut pivoter de 180°.

INIESTA

These luminaires have a USB port for charging and operating the luminaires.

Diese Leuchten verfügen über einen USB-Anschluss, der zum Laden und Betrieb der Leuchten dient.

Faites fonctionner et charger ces luminaires grâce au port USB.

900956 INIESTA

table light; plastic, white, black / plastic, white
Tischleuchte; Kunststoff, weiss, schwarz / Kunststoff, weiss
luminaire de table; plastique, blanc, noir / plastique, blanc

L 330, B 35, H 350, Base: B 160, T 115



3,6W



360lm



Li-ion



1800mAh

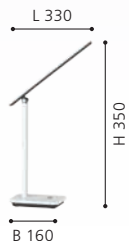

9 008606 277902

900958 INIESTA

table light; plastic, black / plastic, cappuccino, white
Tischleuchte; Kunststoff, schwarz / Kunststoff, cappuccino, weiss
luminaire de table; plastique, noir / plastique, cappuccino, blanc

L 330, B 35, H 350, Base: B 160, T 115



3,6W



360lm



Li-ion



1800mAh

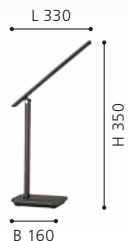

9 008606 277926

900957 INIESTA

table light; plastic, grey, black / plastic, white
Tischleuchte; Kunststoff, grau, schwarz / Kunststoff, weiss
luminaire de table; plastique, gris, noir / plastique, blanc

L 330, B 35, H 350, Base: B 160, T 115



3,6W



360lm



Li-ion



1800mAh

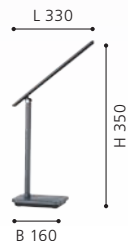

9 008606 277919



900957

LED



93901

LED

93901

The touch buttons can be used to dim the luminaires and adjust the light colour.

Über die Berührungsschalter kann man die Leuchten dimmen und die Lichtfarbe einstellen.

Les interrupteurs tactiles permettent de faire varier l'intensité des luminaires et de régler la couleur de la lumière.

93901 SELLANO

table light; plastic, steel, white, black
 Tischleuchte; Kunststoff, Stahl, weiss, schwarz
 luminaire de table; plastique, acier, blanc, noir

L 360, H 420, Base: B 180, T 180

LED
4W

tunable
WHITE
450lm





LA SECA

These luminaires have a USB port for charging and operating the luminaires.

Diese Leuchten verfügen über einen USB-Anschluss, der zum Laden und Betrieb der Leuchten dient.

Faites fonctionner et charger ces luminaires grâce au port USB.



97044



97045



97044 LA SECA

table light; plastic, white
Tischleuchte; Kunststoff, weiss
luminaire de table; plastique, blanc

L 200, B 50, H 260, Base: B 70, T 50

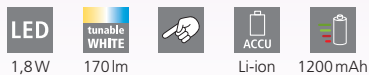

9 002759 970444

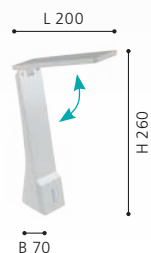

97045 LA SECA

table light; plastic, black
Tischleuchte; Kunststoff, schwarz
luminaire de table; plastique, noir

L 200, B 50, H 260, Base: B 70, T 50

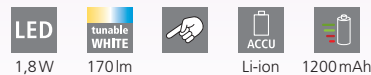

9 002759 970451



DESIGN
HIGHLIGHT
DETAIL



93966

LED



93965

LED

93966 CAUPO

table light; plastic, steel, black
Tischleuchte; Kunststoff, Stahl, schwarz
luminaire de table; plastique, acier, noir

L 260, H 320, Base: B 150, T 150

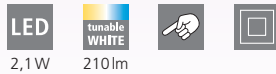

2,1W 210lm



9 002759 939663



93965 CAUPO

table light; plastic, steel, white
Tischleuchte; Kunststoff, Stahl, weiss
luminaire de table; plastique, acier, blanc

L 260, H 320, Base: B 150, T 150



2,1W 210lm



9 002759 939656





900529

LED



900528

LED

900529 BROLINI

table light; plastic, white
Tischleuchte; Kunststoff, weiss
luminaire de table; plastique, blanc

H 550, Ø 150, Base: Ø 150



2,1W



300lm



Li-ion



1500mAh



9 008606 242832



900528 BROLINI

table light; plastic, black
Tischleuchte; Kunststoff, schwarz
luminaire de table; plastique, noir

H 550, Ø 150, Base: Ø 150



2,1W



300lm



Li-ion



1500mAh



9 008606 242825





DESIGN
HIGHLIGHT
DETAIL



97915

LED

97915 COGNOLI

table light; plastic, white
Tischleuchte; Kunststoff, weiss
luminaire de table; plastique, blanc

L 70, B 100, H 510, Base: B 100, T 70

LED

4,4W

neutral
WHITE

430lm



9 002759 979157

97914 COGNOLI

table light; plastic, black
Tischleuchte; Kunststoff, schwarz
luminaire de table; plastique, noir

L 70, B 100, H 510, Base: B 100, T 70

LED

4,4W

neutral
WHITE

430lm



9 002759 979140



97914

LED



96435

LED



96434

LED



96438

LED

96435 LAROA

table light; plastic, white
Tischleuchte; Kunststoff, weiss
luminaire de table; plastique, blanc

L 480, B 120, H 325, Base: B 170, T 120

LED

4,2W

neutral
WHITE

600lm



9 002759 96435 1



96434 LAROA

clamp light; plastic, white
Klemmleuchte; Kunststoff, weiss
luminaire à pince; plastique, blanc

L 450, B 65, H 275

LED

4,2W

neutral
WHITE

600lm



9 002759 96434 4



96438 LAROA

table light; plastic, black
Tischleuchte; Kunststoff, schwarz
luminaire de table; plastique, noir

L 480, B 120, H 325, Base: B 170, T 120

LED

4,2W

neutral
WHITE

600lm



9 002759 96438 2





96437

LED

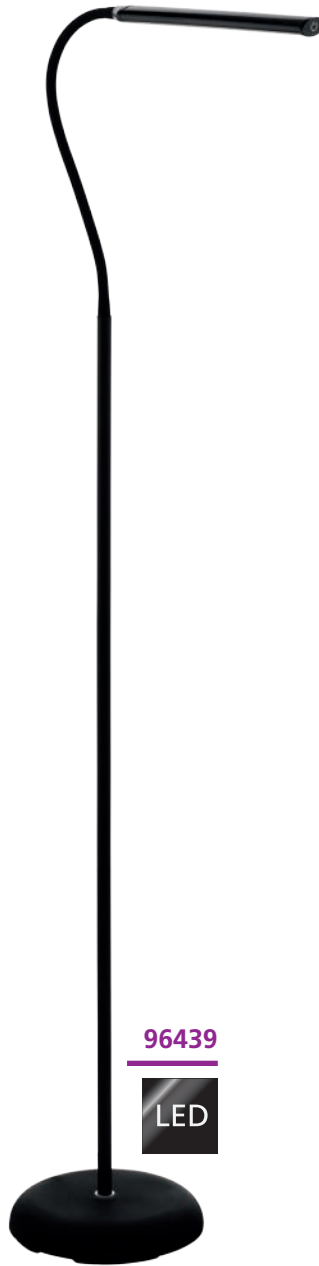

96439

LED



96436

LED

96437 LAROA

clamp light; plastic, black
Klemmleuchte; Kunststoff, schwarz
luminaire à pince; plastique, noir

L 450, B 65, H 275



96439 LAROA

floor light; plastic, black
Stehleuchte; Kunststoff, schwarz
lampadaire; plastique, noir

L 535, B 215, H 1300, Base: Ø 210

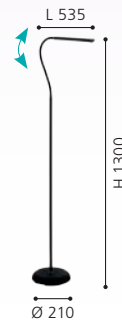

96436 LAROA

floor light; plastic, white
Stehleuchte; Kunststoff, weiss
lampadaire; plastique, blanc

L 535, B 215, H 1300, Base: Ø 210

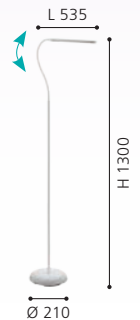



98831



98832

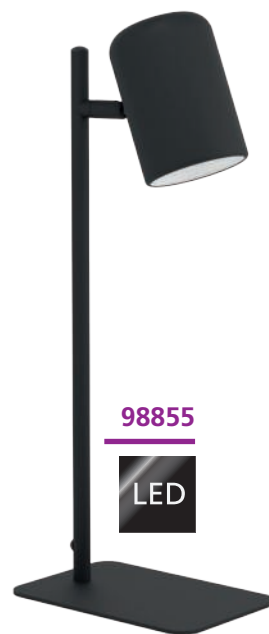

98855



98831 VERADAL

table light; wood, plastic, black, brown / steel, black
Tischleuchte; Holz, Kunststoff, schwarz, braun / Stahl, schwarz
luminaire de table; bois, plastique, noir, marron / acier, noir

B 125, H 490, Base: Ø 160



E27 1x 40W



9 002759 988319



98832 VERADAL

table light; wood, plastic, white, brown / steel, white
Tischleuchte; Holz, Kunststoff, weiss, braun / Stahl, weiss
luminaire de table; bois, plastique, blanc, marron / acier, blanc

B 125, H 490, Base: Ø 160



E27 1x 40W



9 002759 988326



98855 CEPPINO

table light; steel, black, white
Tischleuchte; Stahl, schwarz, weiss
luminaire de table; acier, noir, blanc

H 380, Base: B 165, T 110



GU10 1x 4,5W 1x 345lm



9 002759 988555





98856

LED

98856 CEPPINO

table light; steel, white
Tischleuchte; Stahl, weiss
luminaire de table; acier, blanc

H 380, Base: B 165, T 110



GU10



1x 4,5W



1x
warm
WHITE
345 lm





93078

LED



94673

LED

93078 DURENGO

table light; plastic, steel, white, chrome
Tischleuchte; Kunststoff, Stahl, weiss, chrom
luminaire de table; plastique, acier, blanc, chrome

H 380, Ø 160, Base: Ø 160

LED

warm
WHITE



2,5W

250lm

94673 DAMBERA

table light; plastic, black
Tischleuchte; Kunststoff, schwarz
luminaire de table; plastique, noir

H 375, Base: Ø 170

LED

warm
WHITE



4,5W

660lm

94677 SNAPORA

table light; plastic, aluminium, black
Tischleuchte; Kunststoff, Alu, schwarz
luminaire de table; plastique, aluminium, noir

H 485, Base: Ø 110

LED

warm
WHITE



3W

300lm



9 002759 930783



9 002759 946739



9 002759 946777





94677

LED



93076



93077



99334



93076 GEXO

table light; plastic, steel, black, chrome
Tischleuchte; Kunststoff, Stahl, schwarz, chrom
luminaire de table; plastique, acier, noir, chrome

H 320, Ø 125, Base: Ø 125



2,5W



230lm



9 002759 930769

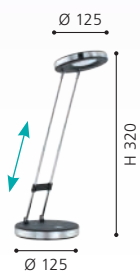

93077 GEXO

table light; plastic, steel, white, chrome
Tischleuchte; Kunststoff, Stahl, weiss, chrom
luminaire de table; plastique, acier, blanc, chrome

H 320, Ø 125, Base: Ø 125



2,5W



230lm



9 002759 930776



99334 CABALES

table light; plastic, white
Tischleuchte; Kunststoff, weiss
luminaire de table; plastique, blanc

H 340, Ø 140, Base: Ø 140



4,6W



490lm



9 002759 993344





99335

LED

99335 CBALES

table light; plastic, black
Tischleuchte; Kunststoff, schwarz
luminaire de table; plastique, noir

H 340, Ø 140, Base: Ø 140





95694

LED



97078

These luminaires have a colored light in the base.

Diese Leuchten verfügen über ein farbiges Licht im Sockel.

Ces luminaires disposent d'une lumière colorée dans le socle.

95694 CAJERO

table light; plastic, silver

Tischleuchte; Kunststoff, silber

luminaire de table; plastique, argent

L 150, B 100, H 500, Base: B 155, T 100

LED

4,5W

neutral
WHITE

687lm



9 002759 956943





95696

LED



95695

LED



97078

LED

95696 CAJERO

table light; plastic, black
Tischleuchte; Kunststoff, schwarz
luminaire de table; plastique, noir

L 150, B 100, H 500, Base: B 155, T 100



4,5W 687lm



9 002759 956967



95695 CAJERO

table light; plastic, white
Tischleuchte; Kunststoff, weiss
luminaire de table; plastique, blanc

L 150, B 100, H 500, Base: B 155, T 100



4,5W 687lm



9 002759 956950



97078 CABADO 1

table light; plastic, white
Tischleuchte; Kunststoff, weiss
luminaire de table; plastique, blanc

L 140, B 110, H 490, Base: B 130, T 105



2,4W 300lm 0,3W 20lm



9 002759 970789



INCL.





DESIGN
HIGHLIGHT
DETAIL

96957

96957 TORONA 1

table light; steel, white / wood, natural
Tischleuchte; Stahl, weiss / Holz, natur
luminaire de table; acier, blanc / bois, nature

L 445, B 180, H 605, Base: Ø 180

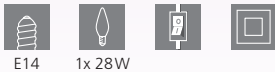

E14 1x 28W



9 002759 969578



99019 TABILLANO 1

table light; steel, black
Tischleuchte; Stahl, schwarz
luminaire de table; acier, noir

L 560, B 180, H 475, Base: Ø 180

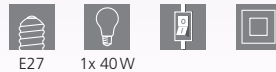

E27 1x 40W



9 002759 990190





99019



94699



94702

DESIGN
HIGHLIGHT
DETAIL



94699 BORGILLIO

table light; steel, white
Tischleuchte; Stahl, weiss
luminaire de table; acier, blanc

L 400, B 190, H 710, Base: Ø 190



E27 1x 40W



9 002759 946999

94702 BORGILLIO

table light; steel, chrome
Tischleuchte; Stahl, chrom
luminaire de table; acier, chrome

L 400, B 190, H 710, Base: Ø 190



E27 1x 40W



9 002759 947026



94697



94704

94697 BORGILLIO

table light; steel, black
Tischleuchte; Stahl, schwarz
luminaire de table; acier, noir

L 400, B 190, H 710, Base: Ø 190



E27 1x 40W



9 002759 946975

94704 BORGILLIO

table light; steel, copper
Tischleuchte; Stahl, kupfer
luminaire de table; acier, cuivre

L 400, B 190, H 710, Base: Ø 190

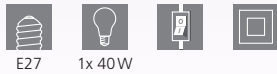

E27 1x 40W

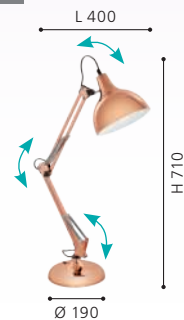

9 002759 947040



90967



DESIGN
HIGHLIGHT
DETAIL

90967 BANKER

table light; steel, brass / painted glass, green
Tischleuchte; Stahl, messing / Glas lackiert, grün
luminaire de table; acier, laiton / verre laqué, marron granit

L 275, H 390



E27



1x 60W



9 002759 909673



FIRMO

These luminaires come with a clip.

Diese Leuchten sind mit einer Klemme ausgestattet.

Ces luminaires viennent avec une pince fixation.



90872



90873



90874

90872 FIRMO

table light; steel, plastic, shiny white

Tischleuchte; Stahl, Kunststoff, weiss glänzend

luminaire de table; acier, plastique, blanc brillant

L 730



E27



1x 40W



9 002759 908720



90873 FIRMO

table light; steel, plastic, shiny black

Tischleuchte; Stahl, Kunststoff, schwarz glänzend

luminaire de table; acier, plastique, noir brillant

L 730



E27



1x 40W



9 002759 908737



90874 FIRMO

table light; steel, plastic, silver

Tischleuchte; Stahl, Kunststoff, silber

luminaire de table; acier, plastique, argent

L 730



E27



1x 40W



9 002759 908744





90977



9228



9229

90977 BASIC 1

table light; plastic, steel, silver
Tischleuchte; Kunststoff, Stahl, silber
luminaire de table; plastique, acier, argent

H 300, Base: Ø 125



E27 1x 40W



9 002759 909772



9228 BASIC

table light; plastic, steel, black
Tischleuchte; Kunststoff, Stahl, schwarz
luminaire de table; plastique, acier, noir

H 300, Base: Ø 125

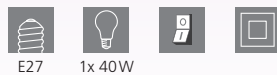

E27 1x 40W



9 002759 922801



9229 BASIC

table light; plastic, steel, white
Tischleuchte; Kunststoff, Stahl, weiss
luminaire de table; plastique, acier, blanc

H 300, Base: Ø 125



E27 1x 40W



9 002759 922900





9230



9232

9230 BASIC

table light; plastic, steel, red
Tischleuchte; Kunststoff, Stahl, rot
luminaire de table; plastique, acier, rouge

H 300, Base: Ø 125



E27 1x 40W



9 002759 923006



9232 BASIC

table light; plastic, steel, blue
Tischleuchte; Kunststoff, Stahl, blau
luminaire de table; plastique, acier, bleu

H 300, Base: Ø 125

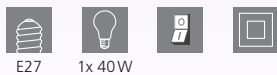

E27 1x 40W



9 002759 923204





DESIGN
HIGHLIGHT
DETAIL



92872

LED

92872 FOX

table light; steel, white, chrome
Tischleuchte; Stahl, weiss, chrom
luminaire de table; acier, blanc, chrome

H 320, Base: Ø 125



GU10 1x 2,8W 1x 250lm



9 002759 928728



92873 FOX

table light; steel, anthracite, chrome
Tischleuchte; Stahl, anthrazit, chrom
luminaire de table; acier, gris anthracite, chrome

H 320, Base: Ø 125

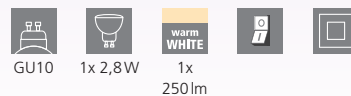

GU10 1x 2,8W 1x 250lm



9 002759 928735





92873

LED



CHILDREN LUMINAIRES

KINDERLEUCHTEN
LUMINAIRES POUR ENFANTS

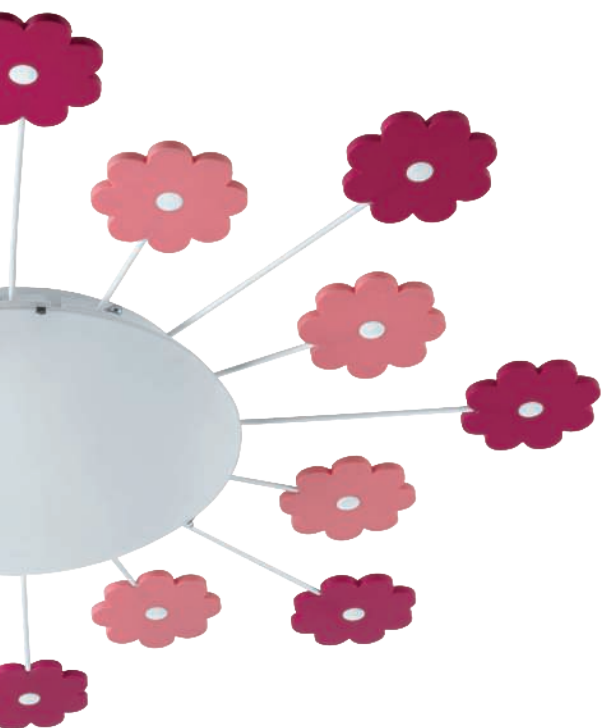

EN **PLAY OF COLOUR**

The nursery luminaires are characterised by their playful and child-friendly designs. The lovely motives light up in many different colours and turn the nursery into a very special location.

DE **FARBENSPIEL**

Die Kinderzimmerleuchten zeichnen sich durch ihr verspieltes und kindgerechtes Design aus. Die liebevollen Motive erleuchten in unterschiedlichsten Farben und machen das Kinderzimmer zu einem besonderen Ort.

FR **JEU DE COULEUR**

Les éclairages de chambres d'enfants se distinguent de leur design joueur et adapté aux enfants. Les sujets formés avec amour sont illuminés dans des couleurs les plus variées et font de la chambre d'enfant un endroit spécial.





OVERVIEW

CHILDREN LUMINAIRES
KINDERLEUCHTEN
LUMINAIRES POUR ENFANTS



JUNIOR 1
866



TABARA
867



VIKI 1
867



This product is available in different colors and shapes. / Dieser Artikel ist in unterschiedlichen Farben und Formen verfügbar. /
Cet article est disponible en différentes couleurs et formes.

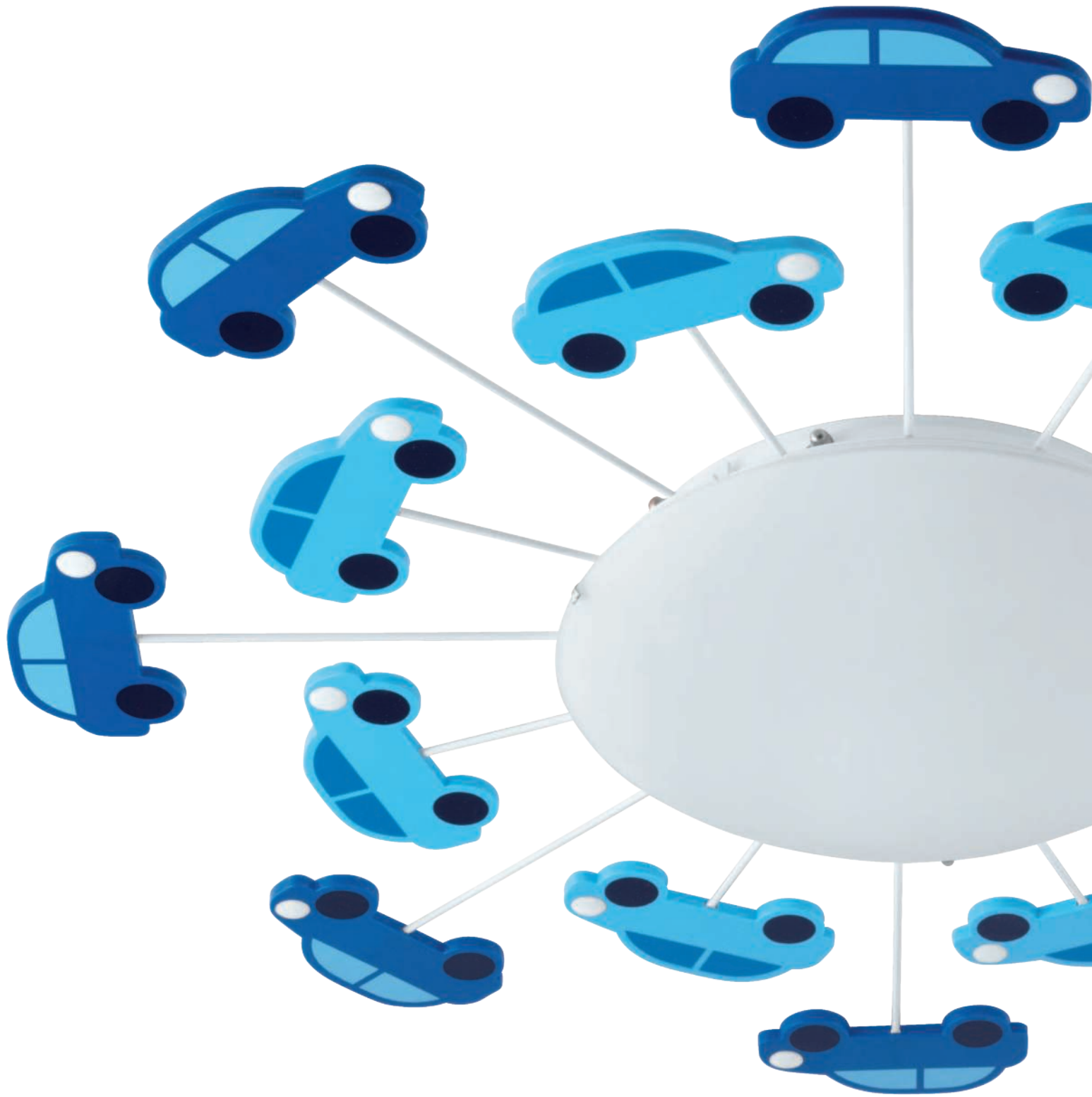



87284



87284 JUNIOR 1

wall/ceiling light; steel, white / satin glass, football motif
Wand- / Deckenleuchte; Stahl, weiss / Glas satiniert, Motiv Fussball
Applique/Plafonnier; acier, blanc / verre satiné, motif football

Ø 245



Ø 245



97667

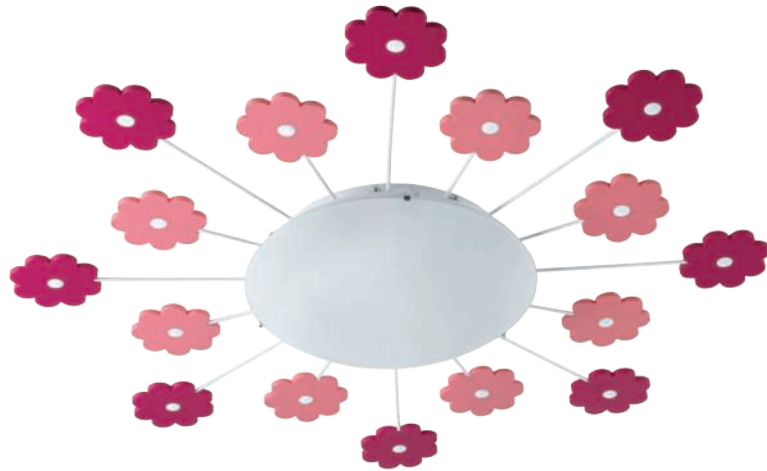

92147

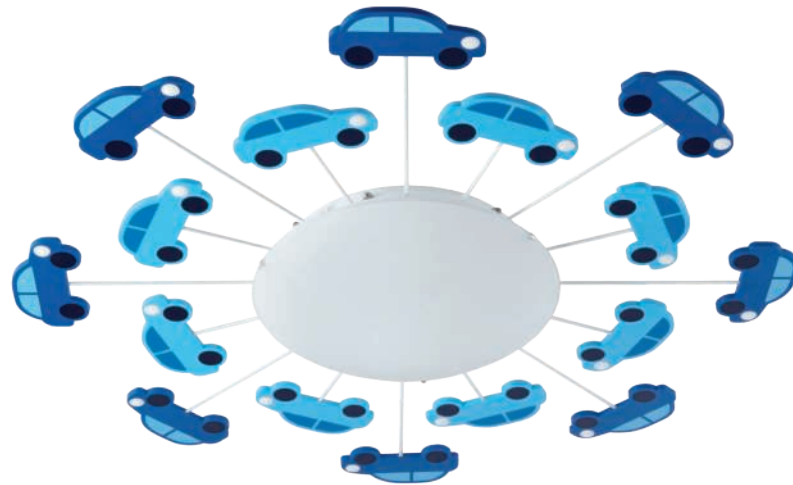

92146

97667 TABARA

ceiling light; wood, steel, green, white / satin glass, football motif
 Deckenleuchte; Holz, Stahl, grün, weiss / Glas satiniert, Motiv Fussball
 plafonnier; bois, acier, vert, blanc / verre satiné, motif football

H 80, Ø 400



9 002759 976675

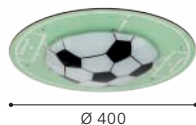

Ø 400

92146 VIKI 1

wall/ceiling light; steel, blue / satin glass, white
 Wand- / Deckenleuchte; Stahl, blau / Glas satiniert, weiss
 Applique/Plafonnier; acier, bleu / verre satiné, blanc

Ø 630, A 80



9 002759 921460



Ø 630

92147 VIKI 1

wall/ceiling light; steel, pink / satin glass, white
 Wand- / Deckenleuchte; Stahl, pink / Glas satiniert, weiss
 Applique/Plafonnier; acier, rose / verre satiné, blanc

Ø 615, A 80



9 002759 921477



Ø 615



KITCHEN & FUNCTIONAL LUMINAIRES

KÜCHEN- & FUNKTIONSLEUCHTEN
LUMINAIRES FONCTIONNELS & DE CUISINE



EN YOUR KITCHEN FRIEND

Our kitchen and function luminaires ensure the right lighting for your workplace and become true supporters. The practical and perfect fitted luminaires ideally refine your kitchen area.

DE IHR KÜCHENFREUND

Unsere Küchen- und Funktionsleuchten sorgen für die richtige Beleuchtung Ihrer Arbeitsfläche und werden zur wahren Alltagshilfe. Die praktischen Unterbauleuchten sind die perfekte Ergänzung für Ihren Küchenbereich.

FR VOTRE AMI DE CUISINE

Nos lumières fonctionnelles et de cuisine assurent le bon éclairage de votre surface de travail et deviennent une aide parfaite dans le quotidien. Les éclairages de meuble sont l'accompagnement parfait de votre espace de cuisine.





OVERVIEW

KITCHEN & FUNCTIONAL LUMINAIRES
KÜCHEN- & FUNKTIONSLEUCHTEN
LUMINAIRES FONCTIONNELS & DE CUISINE



DUNDRY
872-873



TEYA
874



KOB LED
875



This product is available in different colors and shapes. / Dieser Artikel ist in unterschiedlichen Farben und Formen verfügbar. /
Cet article est disponible en différentes couleurs et formes.



DESIGN
HIGHLIGHT
DETAIL



97572 DUNDRY

wall/ceiling light; plastic, white / plastic, white
Wand- / Deckenleuchte; Kunststoff, weiss / Kunststoff, weiss
Applique/Plafonnier; plastique, blanc / plastique, blanc

L 570, B 25, H 35



97573 DUNDRY

wall/ceiling light; plastic, white / plastic, white
Wand- / Deckenleuchte; Kunststoff, weiss / Kunststoff, weiss
Applique/Plafonnier; plastique, blanc / plastique, blanc

L 870, B 25, H 35



97574 DUNDRY

wall/ceiling light; plastic, white / plastic, white
Wand- / Deckenleuchte; Kunststoff, weiss / Kunststoff, weiss
Applique/Plafonnier; plastique, blanc / plastique, blanc

L 1170, B 25, H 35





97571

LED



97571 DUNDRY

wall/ceiling light; plastic, white / plastic, white
Wand- / Deckenleuchte; Kunststoff, weiss / Kunststoff, weiss
Applique/Plafonnier; plastique, blanc / plastique, blanc

L 310, B 25, H 35

LED

3,7W

neutral
WHITE

450lm



9 002759 975715





96081



96081

Mounting type: incl. mounting clips Switch type: sensor switch (on/off)

Befestigungsart: inkl. Montageclips Schalterart: Sensor Schalter (ein/aus)

Type de fixation : clips de montage inclus Type de interrupteur : interrupteur capteur (on/off)

96081 TEYA

under cabinet light; aluminium, silver / plastic, white
Unterbauleuchte; Alu, silber / Kunststoff, weiss
éclairage de meuble; aluminium, argent / plastique, blanc

L 600, B 55, H 25

LED

10W

neutral
WHITE

950lm



9 002759 960810

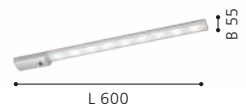



93707



93706



93707 KOB LED

under cabinet light; steel, satin nickel
 Unterbauleuchte; Stahl, nickel-matt
 éclairage de meuble; acier, nickel mat

93706 KOB LED

under cabinet light; steel, white
 Unterbauleuchte; Stahl, weiss
 éclairage de meuble; acier, blanc

L 600, B 70, H 25



L 600, B 70, H 25



9 002759 937072

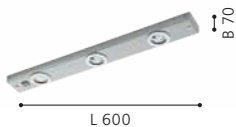

9 002759 937065

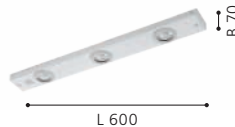



ACCESSORIES

ZUBEHÖR
ACCESSOIRES



EN MAKING IT SPECIAL

Supplement your personal luminaire range with practical accessories and make your everyday life easier.

DE DAS GEWISSE EXTRA

Ergänzen Sie Ihr persönliches Leuchtensortiment mit praktischem Zubehör und erleichtern Sie sich somit Ihren Alltag.

FR LE PETIT PLUS QUI COMPTE

Accompagnez votre collection personnelle de lumières par des accessoires pratiques et facilitez-vous ainsi votre quotidien.





OVERVIEW

ACCESSORIES
ZUBEHÖR
ACCESSOIRES



EXTENTION
881



ELEKTR.TRAFO
882



RUEDA
882



This product is available in different colors and shapes. / Dieser Artikel ist in unterschiedlichen Farben und Formen verfügbar. /
Cet article est disponible en différentes couleurs et formes.

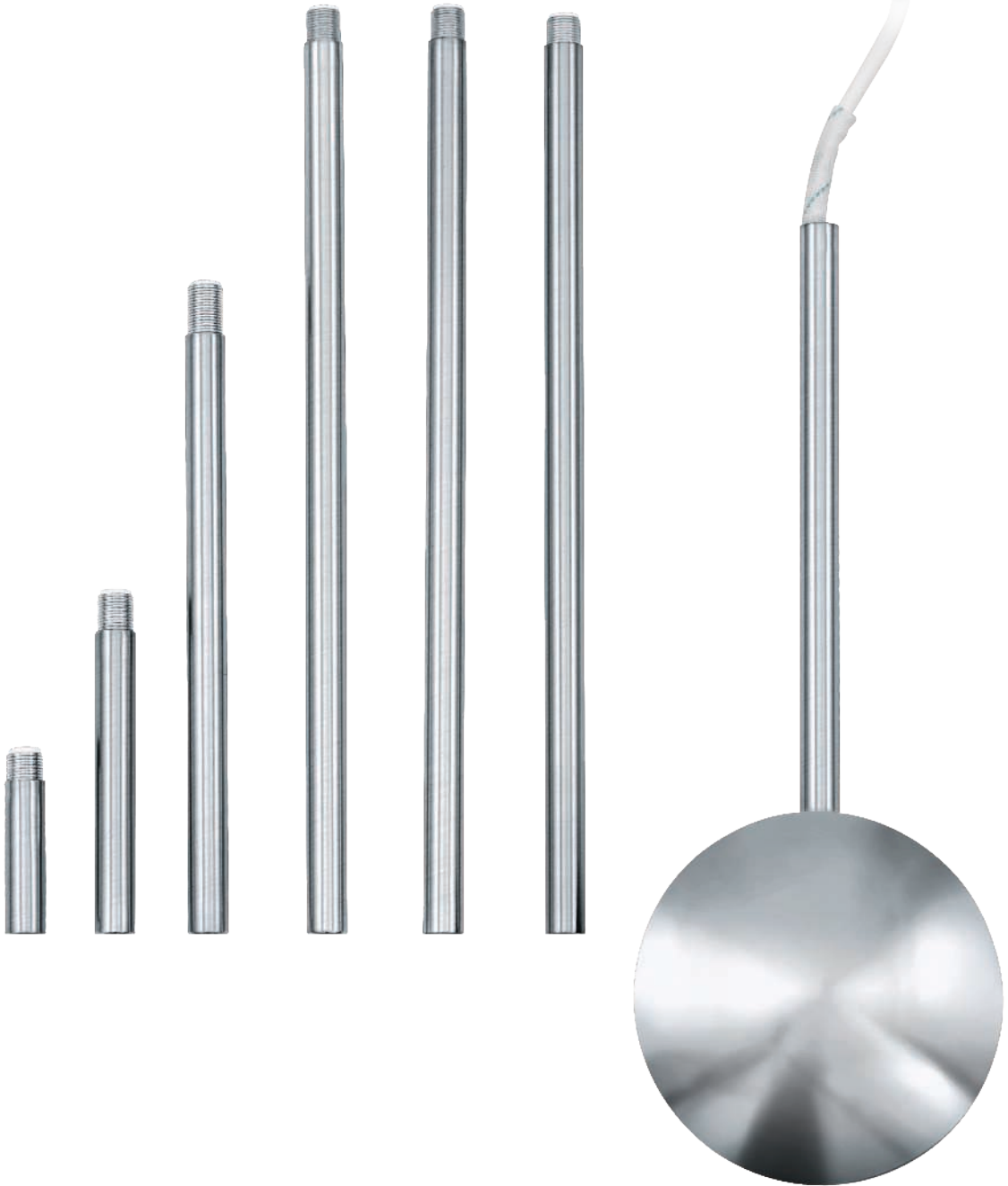



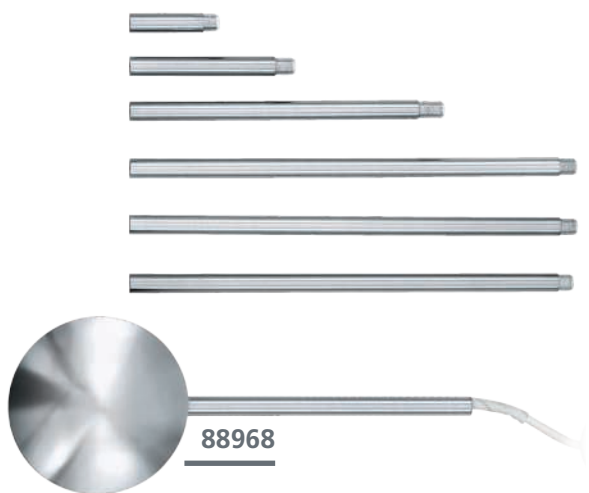
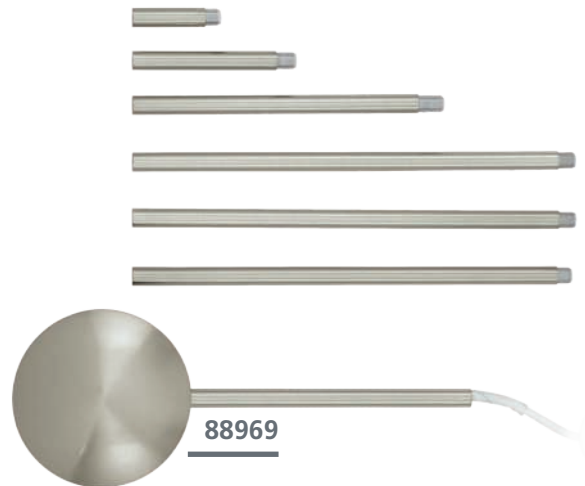

EXTENSION

Can be extended or shortened from 320 to 1570 mm by screwing in/off the single pieces.

Der Kabelkanal kann durch Ein-/Ausdrehen der Einzelstücke von 320 bis 1570 mm verlängert bzw. verkürzt werden.

Le conduit de câble peut être prolongé ou raccourci en vissent/dévisent les pièces uniques de 320 à 1570 mm.

92288 EXTENSION

accessory; steel, white
Zubehör; Stahl, weiss
Accessoires; acier, blanc

L 1570, B 120

88969 EXTENSION

accessory; steel, satin nickel
Zubehör; Stahl, nickel-matt
Accessoires; acier, nickel mat

L 1570, B 120

88968 EXTENSION

accessory; steel, chrome
Zubehör; Stahl, chrom
Accessoires; acier, chrome

L 1570, B 120

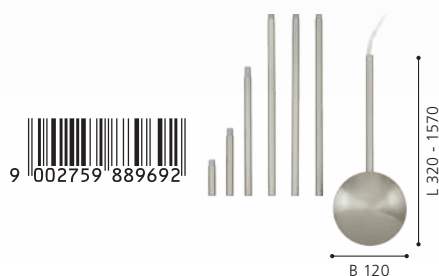



RUEDA

Convert your single-flame luminaires into a three-flame light source for brighter illumination.

Verwandeln Sie Ihre einflammigen Leuchten in eine dreiflammige Lichtquelle für hellere Beleuchtung.

Transforme vos luminaires à une flamme en une source lumineuse à trois flammes pour un éclairage plus lumineux.



92348



98277



98279

92348 ELEKTR.TRAFO

accessory; plastic, white
Zubehör; Kunststoff, weiss
Accessoires; plastique, blanc

L 113, B 44, H 28



10



9 002759 923488



98277 RUEDA

accessory; plastic, white
Zubehör; Kunststoff, weiss
Accessoires; plastique, blanc

H 75, Ø 190



E27 3x 20W



9 002759 982775



98279 RUEDA

accessory; plastic, black
Zubehör; Kunststoff, schwarz
Accessoires; plastique, noir

H 75, Ø 190



E27 3x 20W



9 002759 982799





1



2

98277



3



INDEX & LEGEND

INDEX & ERKLÄRUNG
INDEX & LÉGENDE



EN **INDEX & LEGEND**

On the following pages you will get an insight into EGLO Worldwide, explanations of product pages and pictograms and an overview of the entire catalogue by means of indexes. Afterwards, you will also find space for your personal notes.

DE **INDEX & ERKLÄRUNG**

Auf den folgenden Seiten erhalten Sie einen Einblick in EGLO Weltweit, Erklärungen von Produktseiten und Piktogrammen und einen Überblick über den gesamten Katalog mittels Register. Anschließend finden Sie auch platz für Ihre persönlichen Notizen.

FR **INDEX & LÉGENDE**

Les pages suivantes vous donneront un aperçu d'EGLO Worldwide, des explications sur les pages de produits et les pictogrammes, ainsi qu'une vue d'ensemble du catalogue au moyen d'index. Ensuite, vous trouverez également de la place pour vos notes personnelles.

GLASS MATERIALS

GLAS-MATERIALIEN

MATÉRIAUX DEW VERRE



glass alabaster, white
Glas alabaster, weiß
verre albâtre, blanc

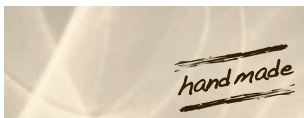

glass alabaster, champagne
Glas alabaster, champagner
verre albâtre, champagne

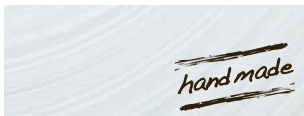

coating, black
Beschichtung, schwarz
revêtement, noir



glass wipe technique, champagner
Glas Wischtechnik, champagner
verre technique à l'essuyés, champagner



limed glass
Glas gekalkt
verre chaulé



brilliant glass
Brillantglas
verre brillant

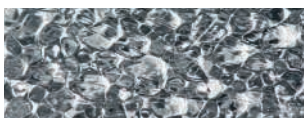

structured glass
Glas mit Struktur
verre structuré blanc



molten splinters of glass/ brilliant glass (granille)
geschmolzene Splitter von Glas / Brillantglas (granille)
éclats fondus de verre / verre brillant (granille)

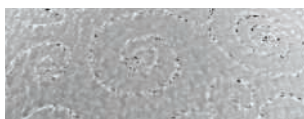

structured glass, white printed decor
strukturiertes Glas, weiß gedrucktes Dekor
verre structuré, décor imprimé blanc



printed glass with decor
bedrucktes Glas mit Dekor
verre imprimé avec la décoration



glass painted, green
Glas lackiert, grün
verre laqué, vert



smoked glass, black-transparent
Rauchglas, schwarz-transparent
verre fumé, noir transparent

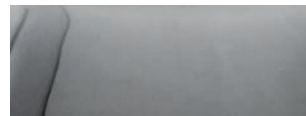

glass vaporized, black-transparent
Glas bedampft, schwarz-transparent
verre vaporisé, noir transparent



glass vaporized, amber
Glas bedampft, amber
verre vaporisé, ambre



gold-color
goldfarben
or



black-brown-transparent
schwarz-braun-transparent
noir-marron-transparent



black-grey-transparent
schwarz-grau-transparent
noir-gris-transparent



glass opal-matt
glas opal-matt
vere opale-mat

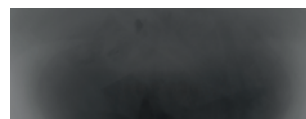

grey-matt
grau-matt
gris mat



sandy
sandfarben
couleur sable

EGLO WORLDWIDE SALES COMPANIES

EGLO WELTWEIT VERTRIEBSGESELLSCHAFTEN

EGLO DANS LE MONDE SOCIÉTÉS DE VENTE



AUSTRIA

EGLO LEUCHTEN GMBH

Heiligkreuz 22
6136 Pill
T: +43 5242 6996 110 | F: +43 5242 6996 972
info-austria@eglo.com



CHILE

EGLO CHILE ILUMINACIÓN LTDA.

Av. Américo Vespucio Norte 1930
Conchali - Santiago de Chile
T: +562 2 595 2222
info-chile@eglo.com



DENMARK

EGLO DANMARK A/S

Agerbakken 20
8362 Hørning
T: +45 70 22 55 11
info-denmark@eglo.com



AUSTRALIA

EGLO LIGHTING AUSTRALIA

5/339 Archerfield Road
4077 Richlands | Queensland
T: +61 7 3375 1413 | F: +61 7 3375 1412
info@eglolighting.com.au



CHINA

DONGGUAN EGLO LIGHTING
COMMERCIAL CO LTD

No.1 | Shangqiao Industrial Rd Shangqiao, Dongcheng
Dongguancity, Guanzhouprovince
T: +86 769 2203 3866 | F: +86 769 2203 6866
info-china@eglo.com



ESTONIA

MOODNE VALGUSTUS AS

Rävala pst. 7
10143 Tallinn
T: +372 667 6670 | F: +372 631 3195
info-estonia@eglo.com



BELGIUM

EGLO BELGIUM BV

Antwerpsesteenweg 247
2950 Kapellen
T: +32 3 250 60 80 | F: +32 3 219 80 67
info-belgium@eglo.com



COLOMBIA

EGLO COLOMBIA ILUMINACIÓN SAS

Autopista Norte 800 Mts adelante del Peaje de los Andes
Costado Oriental Km 19 Lote 30
Bogotá - Chia
T: +57 (1) 744 2339
info-colombia@eglo.com



FINLAND

EGLO FINLAND OY

Malmi raitti 17A
00700 Helsinki
T: +358 20 7649 820
info-finland@eglo.com



BOSNIA AND HERZEGOVINA

EGLO RASVJETA BH D.O.O.

Hrgovi Donji 178
76250 Gradacac
T: +387 35 86 85 00 | F: +387 35 82 44 41
info-Bosnia-Herzegovina@eglo.com | info@eglo.ba



COSTA RICA

EGLO COSTA RICA

Centro Comercial Calle Real local #8 de la sucursal del
BAC San José 800 metros al norte Guachipilín de Escazú
San José, Costa Rica
T: +506-2289-4690 | F: +506-2100-6384
info-costarica@eglo.com



FRANCE

EGLO FRANCE LUMINAIRE SARL

Z.A. Jeune Bois | 2 Rue de la Martinique
68274 Wittenheim
T: +33 3 89 62 50 45 | F: +33 389 6250 49
info-france@eglo.com



BULGARIA

EGLO BULGARIA EOOD

Main Road Burgas-Sofia | 5th kilometer | Building EGLO
8000 Burgas
T: +359 888 755 509
info-bulgaria@eglo.com



CROATIA

EGLO RASVJETA D.O.O.

Jadranska avenija 9
10020 Zagreb
T: +385 1 379 40 62 | F: +385 1 379 41 04
info-croatia@eglo.com



GERMANY

EGLO LEUCHTEN HANDELS GMBH

Kleinbahnstr. 35
59759 Arnsberg
T: +49 2932 6269 0 | F: +49 2932 6269 39
info-germany@eglo.com



CANADA

EGLO CANADA INC.

20700 Route Transcanadienne
H9X 4B7 Baie D'Ufré, Quebec
T: +1 514 457 5483 | F: +1 514 457 5487
info-canada@eglo.com



CZECH REPUBLIC

EGLO CZ+SK s.r.o.

Náchodská 2479/63
193 00 Praha 9
T: +420 281 924 163 | F: +420 281 925 205
info-czechrepublic@eglo.com



GREAT BRITAIN AND IRELAND

EGLO UK LTD.

Unit 12 Cirrus Park, Lower Farm Road, Moulton Park
Industrial Estate, Northampton NN3 6UR
T: +44 1604 790 986
info-UK@eglo.com



GREECE
EGLO HELLAS A.E.

Sykias 2 and parodos dekeleias
13679 Acharnai
T: +30 21 0800 2363
info-greece@eglo.com



HUNGARY
EGLO LUX KFT.

Fő út 143/A
2120 Dunakeszi
T: +36 27 341 353
info-hungary@eglo.com



INDIA
EGLO INDIA PRIVATE LIMITED

A-307, Ansal Chambers - 1, 3, Bhikaji Cama Place,
110066 Delhi
T: +91 85279 44288
info-india@eglo.com



ITALY
EGLO ITALIANA S.R.L.

Via Giotto, 4
31021 Mogliano Veneto (TV)
T: +39 041 45 66 245 | F: +39 041 45 74 066 / 071
info-italy@eglo.com



KAZAKHSTAN
EGLO KAZAKHSTAN LLP

Al-Farabi Avenue 7, Office 72, 14rd floor, Block 4A,
Nurly-Tau Business Center
50059 Almaty
T: +7 727 293 25 20 | M: +7 701 031 00 00
info-kazakhstan@eglo.com



KOSOVO
EGLO KOSOVA LLC

Lugisht e qytetit pn
20000 Prizren
T: +383 44 216 687 | SHOP: +383 49 699 100
info-kosovo@eglo.com



LATVIA
MOODNE VALGUSTUS AS

Rävala pst.7
10143 Tallinn
T: +370 652 49923 | T: +372 667 6670
info-latvia@eglo.com



LITHUANIA
MOODNE VALGUSTUS AS

Rävala pst.7
10143 Tallinn
T: +370 652 49923 | T: +372 667 6670
info-lithuania@eglo.com



MALAYSIA
EGLO ASIA SDN BHD

B-07-13, Empire Soho, Empire Subang, Jalan SS 16/1,
47500 Subang Jaya, Selangor Darul Ehsan.
T: +60162115313
info-malaysia@eglo.com



MEXICO
EGLO MÉXICO ILUMINACIÓN S DE RL DE CV

Prolongación Avenida López Mateos Sur N°3561,
Fraccionamiento Los Gavilanes
C.P. 45645 Tlajomulco de Zúñiga | Jalisco
T: +52 33 3687 20 95
info-mexico@eglo.com



MIDDLE EAST
EGLO LIGHTING MIDDLE EAST FZE

P.O. BOX 262073, LOB6, OFFICE G18
Jebel Ali, Dubai, UAE
T: +97 148810080 | F: +97 148810081
gulf@eglo.com



MOROCCO - EGLO AFRICA
EGLO MAGHREB LUMINAIRES SARL

219 Bd Med Zerktoouni. Suite: 67
20330 Casablanca
T: +212 522 98 80 25 / -05
info-global@eglo.com | info.africa@eglo.com



THE NETHERLANDS
EGLO VERLICHTING NEDERLAND B.V.

Innovatiepark 20
4906 AA Oosterhout (NB)
T: +31 162 48 28 30
info-nl@eglo.com



NORWAY
MS BELYSNING

Gardermovegen 95B
2030 Nannestad
T: +47 63 888500 | F: +47 63 888501
info-norway@eglo.com



PERU
EGLO PERU S.A.C

Av Primavera 1419
Distrito de Santiago de Surco y Departamento de Lima
T: +51 902 763 635
info-peru@eglo.com



POLAND
EGLO POLSKA SP. Z O.O.

Ul. Dźwiękowa 2
02-857 Warszawa
T: +48 22 644 57 55 | F: +48 22 644 89 82
info-poland@eglo.com



PORTUGAL
EGLO PORTUGAL ILUMINAÇÃO, LDA

Rua Fonte Parada, 125
4595-434 Seroa-Paços de Ferreira
T: +351 255 890 000
info-portugal@eglo.com



ROMANIA
EGLO ROMANIA PRODEXIM SRL.

Str. Atomistilor nr. 1D
77125 Magurele - Ilfov
T: +40 314 250 902 | F: +40 314 250 899
info-romania@eglo.com



RUSSIA
EGLO LIGHTING LLC

Varshavskoe shosse 3 | Office 23
117105 Moscow
T: +7495 789 4311 | F: +7495 789 4312
info-russia@eglo.com



SERBIA
EGLO RASVETA DOO

Stefana Prvovenčanog 28
11000 Beograd
T: +381 11 3981 366 | F: +381 11 3981 389
info-serbia@eglo.com



SLOVAKIA
EGLO CZ+SK s.r.o

Náchodská 2479/63
193 00 Praha 9
T: +421 313 211 551 | F: +421 313 211 556
info-slovakia@eglo.com



SLOVENIA
EGLO RASVJETA D.O.O.

Jadranska avenija 9
10020 Zagreb
T: +386 158 093 18
info-slovenia@eglo.com



SPAIN
EGLO ESPAÑA ILUMINACIÓN S.L.

Avda. de Castilla,1 (Edf. Best Point) 2º Planta - Oficina
16A-B
28830 San Fernando de Henares, Madrid
T: +34 91 677 90 44 | F: +34 91 677 03 04
info-spain@eglo.com



SWEDEN
EGLO SVERIGE AB

Star Street 1
512 50 Svenljunga
T: +46 340 623 505
info-sweden@eglo.com



SWITZERLAND
EGLO SCHWEIZ AG

Seetalstrasse 142
6032 Emmen
T: +41 41 268 69 59
info-switzerland@eglo.com



TURKEY
EGLO Aydınlatma ithalat ihracat Ltd. Şti.

Eyüp Sultan Mah. Sekmen Cad. No:18/2
34885 Sancaktepe / Istanbul Samandıra
T: +90 216 311 09 -02 / -03 / -04 |
F: +90 216 311 09 / -05
info-turkey@eglo.com



UKRAINE
EGLO UKRAINE LTD

Vatslava Gavela boulevard, 6/7-A,
03124 Kyiv
T: +38 067 670 58 61
info-ukraina@eglo.com



USA
EGLO USA, INC.

3640 Royal South Parkway
30349 Atlanta, Georgia
T: +1 404 477 5601 | F: +1 404 393 7053
info-usa@eglo.com

HOW TO READ

ERKLÄRUNG

COMMENT LIRE

ARTICLE NUMBER & SERIES NAME
ARTIKELNUMMER & SERIENNAME
NUMÉRO D'ARTICLE & NOM DE LA SÉRIE

DESCRIPTION
BESCHREIBUNG
DESCRIPTION

The product description is composed as follows:
luminaire type; enclosure material, enclosure colour /
glass or shade material, glass or shade colour
Die Produktbeschreibung setzt sich wie folgt zusammen:
Leuchtenart; Gehäusematerial, Gehäusefarbe / Schirm-
bzw. Glasmaterial, Schirm- bzw. Glasfarbe
La description du produit est composée comme suit:
type de luminaire; matériel de boîtier, couleur de boîtier /
matériel de verre ou abat-jour, couleur de verre ou abat-jour

DIMENSIONS
DIMENSIONEN
DIMENSIONS

all dimensions in mm | alle Größen in mm | toutes dimensions en mm

L = length | Länge | longueur

B = width | Breite | largeur

H = height | Höhe | hauteur

∅ = diameter | Durchmesser | diamètre

A = projection length | Ausladung | amplitude

ET = installation depth | Einbautiefe | profondeur utile

Base = base dimensions | Sockelmaße | dimensions de base

Attention! The dimensions relate solely to the sizes of the luminaire.
Any air spaces that would be relevant for a safe operating of the
lamp were not considered.

Achtung! Die Größen beziehen sich nur auf die Abmessungen der
Leuchte. Etwaige Lufträume, die für einen sicheren Betrieb der
Leuchte notwendig sind, werden nicht berücksichtigt.

Attention! Les dimensions se réfèrent à la taille de la lampe seule-
ment. Espacements éventuels, que seraient importants pour une
opération de la lampe sans danger, n'ont pas été considérés.

SKETCHES
SKIZZEN
CROQUIS

The sketches state the most meaningful dimensions. If a product
is adjustable by will, a turquoise arrow marks this function and
only the maximum dimensions are indicated.

Die Bemaßung der Skizzen umfasst jeweils die aussagekräftig-
sten Größen. Bei verstellbaren Produkten kennzeichnet ein
türkiser Pfeil diese Funktion und nur die maximalen Größen
werden angegeben.

Les dimensions des croquis comprennent les plus représenta-
tives. Si un produit est réglable au choix, une flèche turquoise
affiche cette fonction et rien que les dimensions maximales
sont indiquées.

99795 LIBERTAD
pendant light; steel, wood, black, brown
Hängeleuchte; Stahl, Holz, schwarz, braun
luminaire en suspension; acier, bois, noir, marron

L 180, B 180, H 1100

E27 1x 40W

9 002759 997955

L 180 H 1100

99855 LIBERTAD
pendant light; steel, wood, black, brown
Hängeleuchte; Stahl, Holz, schwarz, braun
luminaire en suspension; acier, bois, noir, marron

L 880, B 180, H 1100

E27 3x 40W

9 002759 998554

L 880 H 1100

99856 LIBERTAD
ceiling light; steel, wood, black, brown
Deckenleuchte; Stahl, Holz, schwarz, braun
plafonnier; acier, bois, noir, marron

L 860, B 180, H 240

E27 3x 40W

9 002759 998561

L 860 H 240

LIGHTING FAMILIES / STANDARD
234



**PRODUCT / PRODUCT IN THE AMBIANCE
PRODUKT / PRODUKTE IM AMBIENTE
PRODUITS / PRODUITS DANS L'AMBIENCE**

You can find the article number next to each product on the page and in the ambiance pictures.

Sie finden die Artikelnummer jedes Produktes neben der Abbildung auf der Seite und auf unseren Ambientebildern.

Vous pouvez trouver le numéro d'article à la page et à côté de chaque produit dans les images de l'ambiance.

900349



**CERTIFICATE
ZERTIFIKAT
CERTIFICAT**



Information on FSC® - certified products can be found on page 8.

Informationen über FSC® -zertifizierte Produkte finden Sie auf Seite 8.

Vous trouverez des informations sur les produits certifiés FSC® à la page 8.

**PICTOGRAMMES
PIKTOGRAMME
PICTOGRAMMES**

Technical details are represented as pictograms. An overview over all pictograms can be found on the next pages.

Technische Details werden als Piktogramme dargestellt. Eine Übersicht über alle Piktogramme finden Sie auf den nächsten Seiten.

Les détails techniques sont représentés sous forme de pictogrammes. Vous trouverez un aperçu de tous les pictogrammes dans les pages suivantes.

900349 LIBERTAD 1

pendant light; steel, wood, black, brown
Hängeleuchte; Stahl, Holz, schwarz, braun
luminaire en suspension; acier, bois, noir, marron

L 760, B 140, H 1100

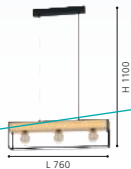

900349

The flower pots are included with this luminaire.

Bei dieser Leuchte sind die Blumentöpfe inkludiert.

Les pots de fleurs sont inclus avec ce luminaire.

**BUTTONS
BUTTONS
BOUTONS**

CRI >90 Colour Rendering Index | Farbwiedergabeindex | Indice de rendu de couleur de LED

INCL. Bulb included | Leuchtmittel inkludiert | ampoules inclus

RECESSED Recessed Luminaire | Einbauleuchte | luminaire encastrable

SURFACE Surface Luminaire | Aufbauleuchte | luminaire en saillie

LIGHTING FAMILIES / STANDARD
235

HOW TO READ / ILLUMINANTS

ERKLÄRUNG / LEUCHTMITTEL

COMMENT LIRE / AMPOULES



















1

PICTOGRAMMES
PIKTOGRAMME
PICTOGRAMMES

Technical details are represented as pictogrammes.

Technische Details werden als Piktogramme dargestellt.

Les détails techniques sont représentés sous forme de pictogrammes.

	Lumen Lumen Lumen		Not dimmable Nicht dimmbar Pas de gradation		Colour rendering index Farbwiedergabeindex L'indice de restitution de couleurs
	Not suitable as main light source Nicht als Hauptleuchtmittel geeignet Ne convient pas comme source lumineuse principale		Step dimmable Stufen dimmbar gradation par étapes		Beamangle Ausstrahlwinkel Angle de rayonnement
	Dimensions in mm Abmessungen in mm Dimensions en mm		Control unit Stufen dimmbar unité de contrôle		Day/night-sensor Tag/Nacht-Sensor Capteur jour/nuit
	Wattage Wattage Puissance		Lifetime Steuereinheit Durée de vie		Motion-sensor Bewegungsmelder Détecteur de mouvement
	Operating voltage Betriebsspannung Tension de fonctionnement		Selling Unit Verpackungseinheit Unité d'emballage		Motion-sensor & day/night-sensor Bewegungsmelder & Tag/Nacht-Sensor Détecteur de mouvement et détecteur jour/nuit
	Socket Socket Douille		Comparative value of brightness to conventional light bulbs Vergleichswert der Helligkeit zu konventionellen Glühlampen Valeur comparative de la luminosité par rapport aux ampoules à incandescence conventionnelles		incl. battery inkl. Batterie incl. pile
	Dimmable Dimmbar Dimmable				



1

12251 GU10-LED





345 lm



2700-6500 K





 L 59, Ø 50

 4.9 W

 220-240V, 50/60Hz

 GU10

 dimmable via remote & app

 15000 h

 4.9 W ~ 50 W

 83 CRI

 45°



9 002759 122515

2

3

DIMMABLE VIA REMOTE AND APP













2

LIGHT COLOUR & KELVIN LICHTFARBE & KELVIN COULEUR LUMINEUX & KELVIN

The colours of the LED are represented as pictogrammes (see below), their luminous flux directly beneath. The luminous flux is quoted in lumen and describes the amount of light generated by the LED. The higher the value, the brighter is the lamp. Lumens are LED boards and are the light measurement value in bulbs.

Die Farben der LED werden als Piktogramm (siehe unten) dargestellt, deren Lichtstrom direkt darunter. Der Lichtstrom wird in Lumen gemessen und gibt die erzeugte Lichtmenge der LED an. Je höher der Wert, desto heller das Produkt. Lichtstromangaben (Lumen) sind Platinen- bzw. Leuchtmittelwerte.

Les couleurs de DEL ont représentés sous forme de pictogrammes, leur flux lumineux directement en dessous. L'unité de flux lumineux est le lumen et il mesure la quantité de lumière générée par les DEL. Plus la valeur est élevée, plus la lampe est lumineuse. Les lumens sont l'unité de mesure de l'intensité lumineuse des ampoules et des panneaux led intégrés.

 RGB	RGB RGB RGB	 RGB+NW	RGB + neutralwhite RGB + neutralweiß RGB + blanc neutral	 cold WHITE	cold white kaltweiß blanc froid
 RGB+W	RGB + white RGB + weiß RGB + blanc	 RGB+TW	RGB + tunable white RGB + tunable white RGB + tunable white	 neutral WHITE	neutral white neutralweiß blanc neutre
 RGB+WW	RGB + warmwhite RGB + warmweiß RGB + blanc chaud	 tunable WHITE	tunable white tunable white tunable white	 YELLOW	Yellow Gelb Jaune
 RGB+CW	RGB + coldwhite RGB + kaltweiß RGB + blanc froid	 warm WHITE	warm white warmweiß blanc chaud	 RED	Red Rot rouge

3

ENERGY EFFICIENCY LABELS ENERGIEEFFIZIENZ-LABEL LABEL DE L'EFFICACITÉ ÉNERGÉTIQUE

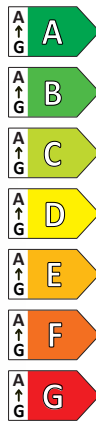
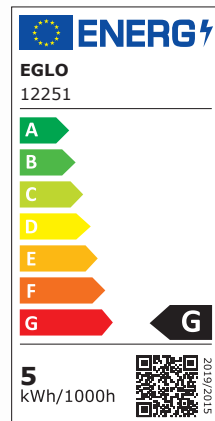

The new energy label must be indicated on all light sources with a luminous flux between 60 and 82,000 lumens and LED. This applies to lamps, LED modules and luminaires where the light source cannot be removed without destroying it. The energy spectrum ranges from A to G.

Das neue Energielabel muss auf allen Lichtquellen mit einem Lichtstrom zwischen 60 und 82.000 Lumen und LED angegeben werden. Dies gilt für Lampen, LED-Module und Leuchten, bei denen die Lichtquelle nicht zerstörungsfrei entnommen werden kann. Das Energiespektrum reicht von A bis G.

Le nouveau label énergétique doit être indiqué sur toutes les sources lumineuses dont le flux lumineux est compris entre 60 et 82 000 lumens et sur les LED. Cela s'applique aux lampes, aux modules LED et aux luminaires dont la source lumineuse ne peut être retirée sans être détruite. Le spectre énergétique va de A à G.

The information on the label includes: /
Die Angaben auf dem Etikett beinhalten: /

Les informations figurant sur l'étiquette sont les suivantes :



















- › Name/Trademark / Name/Warenzeichen / Nom/marque de commerce
- › Model / Modell / Modèle
- › Energy label scale A-G / Energielabel-Skala A-G / Échelle d'étiquetage énergétique A-G
- › Energy consumption for 1,000 hours of use / Energieverbrauch bei 1.000 Stunden Nutzung / Consommation d'énergie pour 1 000 heures d'utilisation
- › Energy efficiency class of the product / Energieeffizienzklasse des Produkts / Classe d'efficacité énergétique du produit
- › QR Code to EPREL (Product Database of the European Product Registry for Energylabelling) / QR Code zur EPREL (Produktdatenbank der European Product Registry for Energylabelling) / Code QR pour EPREL (base de données des produits du registre européen des produits pour l'étiquetage énergétique)

PICTOGRAM





















































PIKTOGRAMME

PICTOGRAMME

SOCKETS / FASSUNGEN / DOUILLES

 LED	 G4	 G53
 2G7	 G5	 GU5,3 / MR16
 2G11	 G9	 GU10
 2GX13	 G10Q	 GX53
 E14	 G13	 GY6,35
 E27	 G23	 R7s

BULBS / LEUCHTMITTEL / AMPOULES

 E14 / C35	 E27 / A60 Halogen	 E27 / E140 Filament
 E14 / C35f	 E27 / R63 Halogen	 E27 / PS160 Filament
 E14 / D45	 E27 / A60 LED	 E27 / T30 Filament
 E14 / C35f LED	 E27 / A60 Filament	 E27 / T32 Filament
 E14 / D45 Halogen	 E27 / A65 LED	 G4 / T9
 E14 / C35 Halogen	 E27 / A75 Filament	 G4 / LT9
 E14 / T22	 E27 / G45 LED	 G4 / LT14
 E14 / C35 Filament	 E27 / G45 Filament	 G9
 E14 / C37 Filament	 E27 / G80 Filament	 G9 LED
 E14 / C35f Filament	 E27 / G95	 GU10
 E14 / C37f Filament	 E27 / G95 Filament	 GU10 LED
 E14 / P45 LED	 E27 / G125	 GU10 SMD LED
 E14 / P45 Filament	 E27 / G95 LED	 GX53 / LF75
 E14 / P50	 E27 / G200 Filament	LED LED board / LED Platine / LED bord
 E14 / ST48 Filament	 E27 / R63 LED	 MR16
 E14 / ST64 Filament	 E27 / ST48 Filament	 MR16 LED
 E14 / T20 LED	 E27 / ST64 Filament	 R7s / 78mm
 E27 / A60	 E27 / B80 Filament	 R7s / 118mm
 E27 / G90	 E27 / BR150 Filament	 R7s / 78mm LED
 E27 / QR63	 E27 / DP165 Filament	 R7s / 118mm LED

LIGHT COLOUR & LUMEN / LICHTFARBE & LUMEN / COULEUR LUMINEUX & LUMEN

The colours of the LED are represented as pictogrammes (see below), their luminous flux directly beneath. The luminous flux is quoted in lumen and describes the amount of light generated by the LED. The higher the value, the brighter is the lamp. Lumens are LED boards and are the light measurement value in bulbs.

Die Farben der LED werden als Piktogramm (siehe unten) dargestellt, deren Lichtstrom direkt darunter. Der Lichtstrom wird in Lumen gemessen und gibt die erzeugte Lichtmenge der LED an. Je höher der Wert, desto heller das Produkt. Lichtstromangaben (Lumen) sind Platinen- bzw. Leuchtmittelwerte.

Les couleurs de LED ont représentés sous forme de pictogrammes, leur flux lumineux directement en dessous. L'unité de flux lumineux est le lumen et il mesure la quantité de lumière générée par les LED. Plus la valeur est élevée, plus la lampe est lumineuse. Les lumens sont l'unité de mesure de l'intensité lumineuse des ampoules et des panneaux led intégrés.

	RGB RGB RGB
	RGB + white RGB + weiß RGB + blanc
	RGB + warmwhite RGB + warmweiß RGB + blanc chaud
	RGB + coldwhite RGB + kaltweiß RGB + blanc froid

	RGB + neutralwhite RGB + neutralweiß RGB + blanc neutral
	RGB + tunable white RGB + tunable white RGB + tunable white
	tunable white tunable white tunable white
	warm white warmweiß blanc chaud

	cold white kaltweiß blanc froid
	neutral white neutralweiß blanc neutre

SWITCHES & SENSORES / SCHALTER & SENSOREN / INTERRUPTEUR & CAPTEURS

	incl. cable & plug inkl. Kabel & Stecker câble & connecteur inclus
	internal dimmer eingebauter Dimmer variateur intégré
	button switch Druckknopf interrupteur de pression
	function switch Funktionschalter interrupteur fonction
	rocker switch Wippschalter interrupteur à bascule
	pedal dimmer Trittdimmer variateur à pied

	pedal switch Trittschalter interrupteur à pied
	cable switch Kabelschalter interrupteur à câble
	incl. cable & plug transformer inkl. Kabel & Stecktransformator câble & transformateur à prise
	remote control Fernbedienung télécommande
	Day & Night Sensor Tag & Nacht Sensor sensor jour & nuit
	sensor Sensor sensor

	swedish plug Stecker Schweden connecteur swede
	"Touch me" ON/OFF "Touch me" EIN/AUS "Touch me" ON/OFF
	"Touch me" ON/OFF & dimm "Touch me" EIN/AUS & Dimmen "Touch me" ON/OFF & graduable
	pull switch Zugschalter interrupteur à bascule
	Timer - automatic on/off Zeitschaltuhr - automatisches Ein- & Ausschalten minuterie - peut être éteint et allumé automatiquement

FUNKTIONS & COMFORT / FUNKTIONEN & KOMFORT / FONCTIONS & CONFORT

	incl. battery inkl. Akku incl. pile
	incl. battery inkl. Batterie incl. pile
	battery specifications Batteriespezifikationen spécifications des piles
	beam angle Ausstrahlwinkel angle de rayonnement
	corner mount possible Eckmontage möglich montage en coin possible
	Colour Rendering Index

	cutout (in mm) Ausschnitt (in mm) perçage du panneau (en mm)
	dimmable with external dimmer dimbar mit externen Dimmer gradable avec un gradateur externe
	not dimmable nicht dimmbar ne pas graduable
	Can be operated via control unit Bedienbar über Steuergerät Peut être commandé par une unité de contrôle
	replaceable LED austauschbare LED LED remplaçables
	loadable in kg belastbar in kg chargeable en kg

	packaging / delivery unit Verpackungs- / Liefereinheit unité d'emballage / de livraison
	shortable kürzbar réductible
	Voltage Volt Voltage
	Watt
	USB connection USB-Anschluss Connexion USB
	Qi-Charger

PROTECTION CLASS / SCHUTZKLASSE / CLASSE DE PROTECTION

The protection class indicates to what extent the lamp is protected against electric shock. All lamps in this catalogue are at least protected with the protection class 1 - a higher class is specified in the information box of the respective lamp.

Die Schutzklasse gibt an, inwiefern ein Produkt gegen einen elektrischen Schlag gesichert ist. Alle Leuchten in diesem Katalog sind mit mindestens Schutzklasse 1 gesichert, bei höheren Klassen wird das Symbol im Infokasten der Leuchte angegeben.

La classe de protection indique, dans quelle mesure la lampe est protégée contre les chocs électriques. Tous les lampes dans ce catalogue sont protégés au moins avec la classe 1 - une classe plus élevée est indiquée dans l'information de la lampe.

	protection class 1: protective earthing Schutzklasse 1: Schutzerdung classe de protection 1: prise de terre
--	---

	protection class 2: protective insulation Schutzklasse 2: Schutzisolierung classe de protection 2: double isolation ou renforcée
--	--

	protection class 3: protective low voltage Schutzklasse 3: Schutzkleinspannung classe de protection 3: très basse tension de sécurité
--	---

PROTECTION RATING / SCHUTZGRAD / INDICE DE PROTECTION

The protection rating ensures the operational safety of luminaires. The first number specifies the extent of the protection against the ingress of foreign bodies; the second number identifies the humidity protection grade. All luminaires in this catalogue are at least protected with the rating IP20 - a higher rating is specified in the information box of the luminaire.

Der Schutzgrad gewährleistet die Betriebssicherheit von Leuchten. Die erste Ziffer des IP Grades beschreibt den Schutzzumfang gegen das Eindringen von Fremdkörpern; die zweite Ziffer informiert über den Grad des Feuchtigkeitsschutzes. Alle Leuchten in diesem Katalog sind mit mindestens Schutzgrad IP20 gesichert, bei höheren Graden wird das Symbol im Infokasten der Leuchte angegeben.

L'indice de protection assure la sécurité opérationnelle des luminaires. Le premier chiffre indique à quel point la protection est efficace contre l'insertion de corps étrangers; le second chiffre indique quant à lui le degré de protection par rapport à l'humidité. Tous les luminaires dans ce catalogue sont protégés au moins avec l'indice IP20 - un indice plus élevé est indiqué dans l'information d'article.

	IP33		IP44
--	------	--	------

	IP54		IP65
--	------	--	------

	IP67
--	------

REGISTER

SERIES NAMES

SERIENNAMEN

NOME DE PRODUITS

NAME NAME NOM	PAGE SEITE PAGE	NAME NAME NOM	PAGE SEITE PAGE	NAME NAME NOM	PAGE SEITE PAGE
ABREOSA	248	ARENAZA	831	BELSIANA	502-503
ACOLLA	523	ARISCANI	362-363	BELSIANA 1	503
AGLIENTINA	203	ARRECIFE	703	BENARIBA	547
AGUILARES	353	BAJAZZARA	212-213	BERREGAS	694
ALAMILO	593	BANDERALO	832	BILBANA	815
ALBANY	469	BANKER	856	BIMEDA	738-741
ALBARACCIN	372-373	BARBANO-Z	28-29	BITACHITO	405
ALBARIZA	196	BARBOTTO	270-273	BOCADELLA	400
ALCUDIA	656	BARI 1	673	BOCADELLA 1	500
ALEANDRO 1	380	BARI-M	630	BOLIVIA	436
ALESSANDRA	469	BARNHAM	734-735	BOLSANO	382
ALMEIDA	205	BARRANCAS	506	BORDONARA	498
ALMEIDA 1	204	BASIC	858-859	BORGILLO	799, 854-855
ALMEIDA 2	200-201	BASIC 1	858	BOYAL	240-243
ALMERA	583	BASILANO	342-343	BRENDA	464-466
ALMONTE	624	BASILANO 1	340-341	BROLINI	839
ALMUDAINA	250-251	BASURTU	518	BUCAMARANGA	178
ALOBRASE	355, 358-361	BATABANO	815	BUDENSEA	796
ALTAFLOR	484-486	BATALLAS	686-687	BUENAVISTA	674
ALVEZ	471	BATISTA	355	BUENAVISTA 1	676
AMANDOLO	480-481	BATISTA 3	381, 813	BUENAVISTA 2	676-677
AMEZAGA	816	BATTISTONA	546	BUTRANO	419
AMEZOLA	620	BAYA	804	BUZZ-LED	756-761
AMONTILLADO	414	BAYA LED	802-803	CABADO	776
ANCHORENA-Z	24-25	BAYMAN	299	CABADO 1	851
ANDABAIA-Z	43	BELESER	367, 795	CABALES	848-849
ANDREAS-Z	23	BELLARIVA	810	CABO	522
ARANZOLA	793	BELLARIVA 3	809	CABO 1	764

NAME NAME NOM	PAGE SEITE PAGE	NAME NAME NOM	PAGE SEITE PAGE	NAME NAME NOM	PAGE SEITE PAGE
CABUS	663	CARPENTO	344	CORREDERA	418
CADAQUES	361	CARTAMA	391	CORTADERAS	406,792
CADAQUES 1	361	CARTIGNANO	590	CORTENOVA	394
CADEGAL	608-609	CASIBARE	252-253,698	COSLADA	710
CAGUANES	452	CASTRALVO	454	COSSANO	224-225
CAHUAMA	812	CAUPO	838	COSSANO 2	224-225
CAJERO	850-851	CAYUCA	743	COSWARTH	700
CALAGRANO	564-565	CENCIARA	461,515	COTORRO	689
CALAGRANO-Z	50-51	CEPPINO	844-845	CREMELLA	254-255
CALMANERA	432-433	CERASELLA	375	CUMIOLE	404
CALNOVA	657	CHIETINO 1	809	CURASAO	430
CAMACHO	238-239	CIGLIE	589	DAKAR 1	728-729
CAMASCA	437	CIUDADELA	423,817	DAKAR 3	778
CAMASTRA	441	CIVITATE	591	DAMASCO 1	821-822
CAMBAITO	436	CLAVELLINA	308-309	DAMBERA	846
CAMBULOS	414	CLEMENTE	383,523	DAVIDA	746-747
CAMINALES-Z	94	CODRIALES	316-317	DAVIDA 1	748-749
CAMPANIA	584	COGNOLI	840	DESIERTO	825
CAMPILO	446	COLTI	584	DUAIA	516
CANICOSA 2	530	COMINIO	357	DUNDRY	872-873
CANTERRAS	246-247	COMPETA 1	548-549	DURELO	569
CAPALBIO	811	CONCESSA 1	194-195	DURENGO	846
CAPASSO	550	CONDRADA 1	522	ELEKTR.TRAFO	882
CAPRAROLA	356,817	CONESA	790	ELIZONDO	604
CARANACOA	312-313	CONESSA	388-389	ELLA	568
CARBONERAS	796	CONNECT Z	21	ENCINITOS	431,505
CARDILLIO 1	766-767,769	CONNECT-Z SENSOR	21	ENEA	730-731
CARDILLIO 2	768-769	CONNECT-Z SWITCH	21	ERMUA	415,815
CARDITO 1	384-385	CONSACA	696	ERSEKA	274-275
CARLTON 2	807	CONTRISA	456	ERVIDEL	306-307
CAROSSO-Z	96-97	CORATO	733	ESCANDELL	266-267
CAROVIGNO	704	CORETTO	377	ESCANDIDOS	262-263

NAME NAME NOM	PAGE SEITE PAGE	NAME NAME NOM	PAGE SEITE PAGE	NAME NAME NOM	PAGE SEITE PAGE
ESPARTAL	791	GENOVESE-Z	53	LANCIANO-Z	90
ESTEPERRA	166, 169, 690	GEO	823	LAROA	842-843
ESTEVAU	422	GERBERA 1	584	LASANA	328
EXTENTION	881	GEXO	848	LASANA 1	324, 329
FABIO	776-777	GIANELLA	318-319	LASANA 2	324-325
FALICETTO	604	GINESTRONE-Z	33	LASANA 3	326-327
FARSALA	365	GIRON	532	LAURITO	556
FATTORIA	218-219	GIRON-S	533	LAZOLO	466
FELONICHE	597	GIRONA	713	LEBALIO	353
FENIGLIA	198-199	GITA 2	660	LED CARPI	636-637
FERENTINO	544-545	GOROSIBA	286-287	LED PALERMO	634-635
FILAGO	452, 521	GOROSIBA 1	286	LED STRIPE-Z	98-99
FIRMO	857	GRADOLI	402	LEJIAS	322-323
FLORESTA	426	GRADOLI 1	403	LIBERTAD	234, 236
FONDACHELLI	788	GRAFIK	581	LIBERTAD 1	235
FORCADET	519	GUANAL	606	LISCIANA	417
FOX	860	GURARE	593	LM_LED_E14	101
FRADELO	526-527	HAYES	605	LM_LED_E27	100-111
FRADELO 1	524-525	HERRORA-Z	74	LM_LED_GU10	101
FRAIOLI-Z	40-41	HORNWOOD-Z	26	LOBATIA	409
FRANIA 534-535, 538-539, 631-632		IMPERIAL	582	LOBINERO-Z	42
FRANIA-A	123	INIESTA	834	LOCANDA	739
FRANIA-S 536-537, 540-541, 631, 633		IPOLITTO	490	LOMALTAS-Z	45
FUEVA 5	638-644, 646	ISIDRO	310-311	LONCINO 1	379
FUEVA-A	128	JUNIOR 1	866	LORD 2	468
FUEVA-Z	76-87	KOB LED	875	LORETO	518-519
GAETANO 1	458-459, 462	KOKOMO-Z	26	LORETO 1	519
GAFARES	488-489	LA SECA	837	LOSALOMAS	435
GASCUERIA	604	LACEY-QI	833	LUBERIO	386
GATUELA 1	412-413	LAGUNITAS	374	LUPPINERIA	560-562
GAZZOLA	439	LANCIANO	542	LURONE	264-265
GEMILIANA	654-655	LANCIANO 1	542-543	MACCACARI	596

NAME NAME NOM	PAGE SEITE PAGE	NAME NAME NOM	PAGE SEITE PAGE	NAME NAME NOM	PAGE SEITE PAGE
MACCHIONE	509	MENTALURGIA	567	NARICES	268-269,407
MADONNINA	818	MESSINARO	502	NARICES 1	268
MAGITTA 1	580	MESTRE	582-583	NASTASIA	202
MAGNUM LED	763	METRASS	610	NEMO	581
MAGNUM-LED	762-763	METRASS 1	613	NEVADO	333
MANALBA	808	METRASS 2	611	NIEVES	553
MANALBA 1	808	MEZZANA	400	NIEVES 1	552
MANILVA 1	632	MINI 4	778-779	NOCITO	736-737
MANIZALES	403	MINIERE	457	NUVANO	461
MANNERA	786-787	MIOGLIA 1	388	OBREGON	447
MANTUNALLE	368	MIRLAS	494	OILELLA	350-351
MANTUNALLE 1	367	MOGANO	512-513	OKINZURI	422
MANZANARES	276-277	MOGANO 1	462	ONEDA	792
MARSALES	172,174	MOGANO 2	514	ONO 2	595
MARBELLA	304-305	MOGANO 3	505	OPTICA	282-284
MARGHERA-Z	36-37	MOHARRAS	515	PADROGIANO-Z	58-60
MARGITTA 1	575	MONIROTE	485,487	PADULARI	482
MARIEL	457,520	MONTEBALDO	405,506	PALAGIANO	565
MARINELLO	493	MONTEFINO	392	PALAGIANO 1	566
MARINELLO 1	492	MONTEFIO	466	PALERMO 2	549
MARMORATA	499	MONTEFIO 1	386-387	PALMERA	672
MAROJALES	520	MONTEMORELOS-Z	52-53	PALMITAL	628-629
MARONDA	205	MONTENOVO	531	PALOMARO	142-143
MARS	577-578	MORDAZO	507	PALOMARO 1	143
MARS 1	576-577	MOSIANO	630	PALOMBAIA	216
MARYVILLA	354,817	MULEGES	428	PALOZZA	335
MASERLO	180-181, 184-186, 188-193	MURCIA	300-301	PALOZZA 1	334
MASERLO 1	182-183	MURMILLO	364	PANAGRIA	244-245
MASERLO 2	180, 186, 189, 192	MURNIA	814	PANDELLA 1	666-669
MASETA	424-425	MUSURITA	554-555	PANDELLA 2	666,670
MASSERIE	830	NADINA	791	PARANDAY-Z	46-47
MATTANZA	220	NARANJO	825	PARRAPOS-Z	48-49

NAME NAME NOM	PAGE SEITE PAGE	NAME NAME NOM	PAGE SEITE PAGE	NAME NAME NOM	PAGE SEITE PAGE
PASCAL 1	583	REMIDOS	609	SALOME	578-579
PASSA	600-603	RENDE	551	SALTO	770-771
PASTERI	138-141, 146-153, 155-161, 806	RICCIO 1	777	SALVILANAS-Z	34-35
PASTORE	144	RIVATO	298	SAMBATELLO	706-707, 709
PASTORE 1	144	ROCAMAR	376, 378	SAN PERI	586
PASTORE 2	145	ROCAMAR 1	377-378	SAN PERI 1	621
PEGUERA	653	ROCCAFORTE	442-445	SANIA 4	598-599
PENJAMO	563	ROLIMARE	483	SANIA 5	650-651
PENJAMO 1	562	ROMAGNESE	380	SARGINTO	614-615
PESCAITO	554	ROMAO	136-137	SARONA	408, 816
PETTO 1	814	ROMAO 1	136	SARRIA	750-753
PICACHA	799	ROMAO 3	136-137	SARSINA-A	124
PICCOLA	785	ROMAO-Z	30	SARSINA-Z	68-69
PIEDRITAS	510	ROMAZZINA	256-259	SAVATARILA-Z	62-63
PINETINA	407	ROMENDO 1	648-649	SAVOY	302-303
PINETTO	634-635	RONCADE	331, 334	SCALEA 1	580
PINTO	294-295	RONCADE 1	330	SEGEZIA	440
PINTO GOLD	292-293	RONDO	278-280	SEGOVIA	214-215
PINTO NERO	290	RONDO 3	280, 407	SELLANO	836
PINTO TEXTIL	289	RONDO 4	794	SELUCI	556-557
PINTO TEXTIL 1	288	ROTTELO	754-755	SELVINA	331-332, 335
PLANET	570	ROVIRA	413	SELVINA 1	330
PLANET 1	570-573	ROVITO-Z	54-57	SELVINO	370-371
PODERE	438	RUEDA	882	SENDERO	226-227
POLLICA	692	RUOTALE	417, 482	SERAS	722-723, 726-727
PORTICO-Z	27	RUSTICARIA	217	SERAS 1	720-721
POZONDON	531	SABINAR	448-449, 451	SERAS 2	724-725
POZUETA	399	SALICETO-Z	95	SIBERIA	320-321
POZUETA 1	397	SALITERAS-Z	63	SIDERNO	650
RAMON	441	SALITRE	418	SILENTINA	508-509
RAZONI	420-421	SALOBRENA-A	126-127	SILERAS	541
RAZONI 1	420-421	SALOBRENA-Z	70-73	SILERAS-Z	91

NAME NAME NOM	PAGE SEITE PAGE	NAME NAME NOM	PAGE SEITE PAGE	NAME NAME NOM	PAGE SEITE PAGE
SILVARES	410	TIMPAROSSA	592	VENEZUELA	260-261
SIMOLARIS-Z	38-39	TINDORI	222-223	VERADAL	844
SLIM	821	TIRRENARA	492	VERADAL-QI	833
SNAPORA	846	TOLLOS-Z	31	VERDELLO	653-654
SOLO	821	TOLORICO	626	VERGIANO	745
SOLO 1	820	TORONA 1	852	VETRO	470-471
SOLO 2	819	TORRETTA	657	VIGLIONI	453
SOREGO	744	TOTARI-Z	88-89	VIKI 1	867
SORRENTA 1	529	TOWNSHEND 3	682-685	VILANOVA	764-765
SPADAFORA	414	TRAGACETE 1	658-659	VINCHIO	670
STAITI	507	TREMEDAL	501	VINOVO	300
STAITI 1	586	TRONDIO	809	VISERBELLA	162-164
STELLATO 1	220-221	TROY 3	296-297	WASAO 1	632
STELLATO 2	221	TRUNCA	830	YUKU-Z	27
STELLATO 3	221	TUDONS	595	ZAMPOTE	490
STICKER	673	TURCONA-Z	64,66-67	ZAPATA	719
SWARBY	813	TURIALDO	232	ZAPATA 1	716
TABARA	867	TURIALDO 1	813	ZARAGOZA	176-177
TABIANO	663	ULISANO	482	ZERACO	753
TABIANO-Z	44	UP 2	800-801	ZILLERIO-Z	42
TABILLANO	714	VADUMI	664	ZINACUA	593
TABILLANO 1	852	VALBIANO	691	ZOCABON	426
TAMARA 1	622-623	VALCASOTTO	559	ZOLA	672
TAMURIA	496	VALCASOTTO 1	517	ZUBIALDE	594
TANURA	606	VALDIOLA	434	ZUBIETA-A	120-122
TARANDELL	329	VALLASPRA	381		
TAREGA	411	VALLEMARE	529		
TARRAFO	453,517	VALLEROSA	314-315		
TAZZOLI	589	VALMORA	332-333		
TELIMBELA-Z	92-93	VARILLAS	171		
TERRAROSA	429	VARRAZO	385		
TEYA	874	VELASCO	210-211		

REGISTER

ARTICLE NUMBER

ARTIKELNUMMER

NUMÉROS D'ARTICLE

NUMBER NUMMER NUMÉRO	PAGE SEITE PAGE	NUMBER NUMMER NUMÉRO	PAGE SEITE PAGE	NUMBER NUMMER NUMÉRO	PAGE SEITE PAGE	NUMBER NUMMER NUMÉRO	PAGE SEITE PAGE	NUMBER NUMMER NUMÉRO	PAGE SEITE PAGE	NUMBER NUMMER NUMÉRO	PAGE SEITE PAGE
3041	470	12245	109	31577	151	31997	334	39092	342	82844	801
3355	469	12251	101	31578	155	32048	328	39093	343	82942	570
7184	578	12252	101	31581	146	32051	566	39094	343	83119	581
7186	578	12253	100	31582	150	32052	566	39095	342	83132	581
7188	579	12254	101	31588	157	32053	566	39099	340	83153	570
9228	858	12255	110	31589	146	32428	758	39101	340	83154	571
9229	858	12256	110	31592	150	32429	758	39102	341	83155	570
9230	859	12257	110	31594	159	32431	758	39103	340	83156	571
9232	859	12258	111	31595	149	32432	759	39113	344	83157	572
12221	106	30658	608	31596	153	32433	759	39114	344	83159	572
12222	106	30659	608	31599	185	32765	716	43637	513	83162	572
12223	106	30832	748	31601	180	32766	716	80263	577	83163	573
12224	107	30833	749	31602	189	32767	716	80264	577	83404	568
12225	107	30834	749	31603	191	33168	683	80265	578	83406	672
12226	102	30835	749	31605	185	33169	682	81262	776	84028	581
12227	102	30931	522	31606	180	33171	682	81265	777	85104	820
12228	102	31001	738	31607	189	33172	682	81635	568	85261	278
12229	103	31002	738	31608	192	33184	760	81636	568	85262	278
12231	103	31003	739	31611	184	33185	760	81827	823	85263	279
12232	103	31004	738	31613	188	33186	760	81828	823	85264	279
12233	104	31005	740	31614	191	33187	761	82305	821	85832	673
12234	104	31006	741	31616	184	33344	444	82741	582	85856	304
12235	104	31007	741	31618	188	33345	442	82747	303	85857	304
12236	105	31008	741	31627	186	33677	623	82748	302	85858	305
12237	105	31571	156	31629	190	33678	623	82749	302	85859	304
12239	105	31572	146	31631	192	33682	636	82751	303	85971	804
12241	108	31573	151	31666	465	33941	608	82752	303	85974	804
12242	108	31574	155	31667	385	33942	609	82785	471	85977	296
12243	108	31575	157	31995	331	33964	609	82842	800	85978	296
12244	109	31576	147	31996	331	33984	286	82843	800	85979	296

NUMBER NUMMER NUMÉRO	PAGE SEITE PAGE	NUMBER NUMMER NUMÉRO	PAGE SEITE PAGE	NUMBER NUMMER NUMÉRO	PAGE SEITE PAGE	NUMBER NUMMER NUMÉRO	PAGE SEITE PAGE	NUMBER NUMMER NUMÉRO	PAGE SEITE PAGE	NUMBER NUMMER NUMÉRO	PAGE SEITE PAGE
85981	297	89832	294	91433	300	92743	298	93836	377	94605	462
85982	297	89833	295	91496	466	92761	382	93874	803	94606	462
86712	582	89834	294	91589	279	92762	382	93875	802	94609	764
86715	583	89835	294	91971	299	92872	860	93876	802	94612	663
86811	283	89836	295	92084	746	92873	860	93877	802	94613	663
86812	283	90043	580	92085	746	92924	778	93901	836	94617	657
86813	284	90304	290	92086	746	92925	778	93917	800	94626	630
86814	284	90305	290	92087	747	92933	779	93952	143	94635	224
86815	284	90697	584	92143	584	92935	778	93965	838	94636	224
86817	282	90737	584	92146	867	93003	295	93966	838	94673	846
87008	468	90872	857	92147	867	93046	809	94244	391	94677	846
87009	468	90873	857	92206	791	93073	386	94245	391	94697	855
87054	466	90874	857	92251	421	93076	848	94252	739	94698	799
87055	465	90914	754	92252	420	93077	848	94319	380	94699	854
87219	672	90915	754	92288	881	93078	846	94329	777	94702	854
87222	672	90916	754	92348	882	93085	764	94377	379	94704	855
87254	820	90917	755	92563	299	93358	765	94378	379	94705	799
87256	820	90927	755	92595	756	93359	764	94388	421	94712	660
87284	866	90967	856	92596	756	93373	446	94389	420	94713	660
87793	583	90977	858	92597	756	93374	446	94513	814	94714	660
88472	728	90978	469	92598	757	93397	142	94547	512	94716	657
88473	728	90982	731	92599	757	93468	466	94548	512	94764	225
88474	729	90984	730	92641	762	93625	384	94584	735	94765	225
88475	729	90985	730	92642	762	93626	384	94585	734	94878	624
88968	881	90986	730	92643	762	93679	753	94586	734	94879	624
88969	881	91002	301	92644	763	93706	875	94587	734	94884	632
89115	583	91004	300	92645	763	93707	875	94589	376	94918	157
89238	577	91006	301	92727	522	93708	387	94591	376	94919	148
89239	576	91238	821	92741	298	93709	386	94592	378	94921	151
89248	576	91242	823	92742	298	93784	387	94593	378	94924	158

NUMBER NUMMER NUMÉRO	PAGE SEITE PAGE	NUMBER NUMMER NUMÉRO	PAGE SEITE PAGE	NUMBER NUMMER NUMÉRO	PAGE SEITE PAGE	NUMBER NUMMER NUMÉRO	PAGE SEITE PAGE	NUMBER NUMMER NUMÉRO	PAGE SEITE PAGE	NUMBER NUMMER NUMÉRO	PAGE SEITE PAGE
94925	148	95257	225	95569	324	95789	807	96117	575	96437	843
94926	152	95261	224	95591	221	95824	763	96178	766	96438	842
94935	459	95282	636	95597	220	95912	389	96179	766	96439	843
94936	459	95283	637	95598	221	95913	388	96181	767	96474	471
94938	462	95284	523	95602	220	95914	389	96182	766	96477	158
94958	751	95285	523	95606	221	95993	622	96183	767	96478	148
94959	751	95286	383	95629	770	95994	622	96193	226	96479	152
94961	751	95287	383	95631	771	95995	622	96194	226	96481	155
94962	750	95364	602	95632	771	96023	550	96195	226	96483	161
94963	752	95368	601	95639	523	96032	548	96199	227	96484	160
94964	752	95371	602	95655	526	96033	548	96201	227	96528	380
94965	753	95373	603	95656	526	96034	548	96211	222	96538	143
94966	752	95377	601	95657	527	96037	610	96214	223	96539	143
94973	569	95379	602	95659	527	96038	610	96229	632	96541	648
94987	673	95383	447	95661	527	96039	613	96257	222	96542	648
94995	205	95385	447	95672	580	96041	613	96258	223	96543	649
94998	635	95386	808	95679	549	96042	611	96261	600	96544	648
94999	635	95482	736	95682	549	96043	611	96264	600	96552	722
95045	160	95483	736	95684	549	96048	595	96305	333	96553	723
95055	190	95484	737	95686	790	96049	595	96306	335	96554	723
95118	158	95485	736	95689	529	96064	668	96308	332	96555	723
95119	153	95522	410	95694	850	96065	668	96326	332	96566	589
95147	328	95523	410	95695	851	96066	668	96327	332	96567	589
95164	159	95525	411	95696	851	96073	471	96329	331	96773	364
95166	153	95526	411	95725	806	96081	874	96331	333	96774	364
95167	149	95539	788	95726	806	96089	575	96332	333	96866	329
95169	186	95541	788	95755	461	96102	324	96343	365	96937	663
95171	190	95545	719	95775	822	96103	325	96344	365	96957	852
95172	193	95546	719	95776	822	96104	324	96345	365	96981	449
95173	181	95547	719	95785	821	96105	325	96434	842	96982	449
95192	205	95567	329	95787	807	96106	325	96435	842	96983	449
95194	205	95568	329	95788	807	96111	575	96436	843	96985	451

NUMBER NUMMER NUMÉRO	PAGE SEITE PAGE	NUMBER NUMMER NUMÉRO	PAGE SEITE PAGE	NUMBER NUMMER NUMÉRO	PAGE SEITE PAGE	NUMBER NUMMER NUMÉRO	PAGE SEITE PAGE	NUMBER NUMMER NUMÉRO	PAGE SEITE PAGE	NUMBER NUMMER NUMÉRO	PAGE SEITE PAGE
96986	451	97542	533	97652	293	97871	534	98112	684	98323	542
97044	837	97543	533	97653	292	97872	534	98113	684	98324	542
97045	837	97571	873	97655	293	97873	534	98114	684	98325	553
97054	626	97572	872	97667	867	97874	538	98134	706	98326	553
97055	626	97573	872	97682	195	97875	538	98135	706	98331	508
97056	626	97574	872	97683	195	97876	538	98136	707	98332	508
97059	670	97577	541	97684	194	97877	536	98137	706	98333	508
97066	422	97578	541	97685	194	97878	536	98201	127	98334	509
97077	776	97583	271	97699	624	97879	536	98203	127	98346	400
97078	851	97584	271	97718	650	97881	540	98205	126	98347	400
97081	664	97587	381	97719	650	97882	540	98206	126	98353	441
97082	664	97589	813	97731	506	97883	541	98207	124	98379	604
97083	664	97604	406	97733	405	97884	631	98208	124	98384	367
97361	335	97605	406	97734	405	97885	632	98209	124	98386	795
97362	335	97611	138	97737	542	97886	586	98212	128	98387	795
97366	392	97612	141	97773	810	97895	507	98236	123	98393	720
97367	392	97613	139	97774	810	97904	507	98237	123	98394	720
97368	392	97614	140	97777	136	97914	840	98247	830	98395	721
97479	144	97615	138	97778	136	97915	840	98263	589	98396	720
97487	529	97616	141	97779	136	97965	628	98277	882	98397	725
97506	745	97617	139	97783	137	97966	629	98279	882	98398	724
97507	745	97618	140	97784	137	98016	402	98292	128	98399	725
97508	745	97619	138	97793	381	98017	402	98293	128	98408	725
97516	809	97621	141	97806	792	98023	531	98294	123	98409	144
97526	532	97641	162	97838	144	98034	502	98297	126	98421	598
97527	532	97642	163	97839	292	98035	503	98309	791	98422	598
97528	532	97643	162	97841	442	98056	394	98311	171	98423	598
97531	630	97644	162	97845	442	98057	394	98313	171	98424	599
97536	691	97645	164	97846	443	98058	394	98314	171	98425	599
97537	691	97646	164	97854	445	98071	441	98317	500	98426	599
97538	691	97647	164	97855	445	98093	830	98318	500	98446	535
97541	533	97651	292	97857	445	98111	685	98319	500	98447	539

NUMBER NUMMER NUMÉRO	PAGE SEITE PAGE	NUMBER NUMMER NUMÉRO	PAGE SEITE PAGE	NUMBER NUMMER NUMÉRO	PAGE SEITE PAGE	NUMBER NUMMER NUMÉRO	PAGE SEITE PAGE	NUMBER NUMMER NUMÉRO	PAGE SEITE PAGE	NUMBER NUMMER NUMÉRO	PAGE SEITE PAGE
98448	537	98614	358	98735	464	98862	494	99076	700	99266	644
98449	540	98615	358	98752	287	98863	494	99077	232	99267	644
98487	531	98616	358	98753	287	98864	816	99078	232	99268	646
98488	531	98617	359	98754	287	98874	306	99079	232	99269	646
98492	414	98621	704	98755	604	98875	306	99086	594	99271	646
98495	414	98622	704	98759	604	98876	306	99087	594	99272	166
98501	670	98623	704	98762	714	98877	307	99093	275	99273	166
98502	670	98624	692	98763	714	98878	307	99094	275	99274	166
98507	501	98625	692	98764	714	98881	503	99095	275	99275	169
98514	520	98626	692	98831	844	98882	503	99096	274	99276	690
98523	372	98628	388	98832	844	98887	822	99097	274	99277	690
98524	372	98629	388	98834	403	98888	610	99098	274	99278	690
98525	373	98647	360	98835	403	98889	334	99099	21	99279	169
98526	372	98648	361	98836	415	98891	122	99106	21	99286	289
98527	530	98649	360	98837	815	98892	122	99113	796	99287	289
98541	596	98651	362	98838	435	98893	122	99122	620	99288	289
98542	596	98652	362	98839	435	98894	120	99123	620	99292	238
98543	596	98653	363	98841	593	98895	120	99124	620	99293	238
98544	597	98654	363	98842	77	98896	120	99202	638	99294	238
98545	597	98661	399	98843	83	98907	667	99203	638	99295	239
98582	361	98662	399	98844	79	98908	666	99204	641	99296	239
98585	361	98663	399	98845	84	98909	400	99205	640	99297	669
98587	204	98677	666	98846	80	99019	852	99206	638	99314	353
98588	204	98685	530	98847	86	99042	182	99207	639	99315	326
98591	454	98689	422	98849	82	99043	182	99208	640	99316	326
98592	454	98694	370	98852	85	99045	182	99209	640	99317	326
98595	377	98695	371	98854	86	99046	183	99211	643	99318	327
98596	378	98696	370	98855	844	99052	694	99212	642	99319	327
98601	555	98697	370	98856	845	99053	694	99213	642	99321	330
98602	555	98698	371	98858	405	99054	694	99214	642	99322	330
98603	554	98699	371	98859	813	99074	700	99249	418	99323	330
98604	555	98734	464	98861	494	99075	700	99265	644	99324	524

NUMBER NUMMER NUMÉRO	PAGE SEITE PAGE	NUMBER NUMMER NUMÉRO	PAGE SEITE PAGE	NUMBER NUMMER NUMÉRO	PAGE SEITE PAGE	NUMBER NUMMER NUMÉRO	PAGE SEITE PAGE	NUMBER NUMMER NUMÉRO	PAGE SEITE PAGE	NUMBER NUMMER NUMÉRO	PAGE SEITE PAGE
99325	524	99447	196	99541	189	99606	614	99661	430	99698	419
99327	525	99457	241	99542	192	99607	614	99662	430	99699	553
99328	524	99463	413	99543	180	99608	615	99663	461	99701	453
99329	808	99464	412	99544	246	99609	614	99664	505	99702	453
99331	808	99466	243	99545	246	99611	201	99665	431	99703	563
99332	809	99467	242	99546	247	99612	200	99666	431	99704	563
99334	848	99468	242	99547	247	99613	172	99667	518	99705	426
99335	849	99469	243	99548	74	99614	350	99669	95	99706	426
99339	659	99486	200	99549	74	99615	350	99671	95	99707	426
99343	547	99487	200	99551	252	99616	350	99672	95	99711	696
99344	547	99488	686	99552	252	99617	351	99673	94	99712	696
99345	254	99489	686	99553	252	99618	428	99674	94	99713	696
99346	254	99491	686	99554	253	99619	428	99675	94	99715	799
99347	255	99492	687	99555	253	99621	559	99676	45	99731	666
99348	586	99506	255	99559	334	99622	559	99677	45	99772	674
99353	241	99507	255	99561	311	99623	559	99678	34	99773	674
99358	316	99508	145	99562	310	99624	240	99679	34	99774	674
99366	368	99509	145	99563	311	99625	242	99681	34	99776	658
99367	368	99511	248	99564	311	99628	375	99682	35	99777	658
99368	368	99512	248	99591	269	99629	375	99683	35	99778	658
99371	367	99513	248	99592	269	99631	286	99684	98	99779	556
99395	483	99517	698	99593	268	99632	286	99685	98	99781	557
99397	567	99518	698	99594	269	99633	425	99686	99	99782	556
99398	567	99519	698	99595	590	99634	424	99687	99	99783	556
99406	554	99523	174	99596	591	99635	424	99689	593	99784	486
99407	554	99524	172	99597	825	99636	424	99691	651	99785	486
99408	240	99525	172	99599	414	99639	74	99692	650	99786	486
99413	240	99526	174	99601	38	99651	374	99693	432	99787	485
99438	440	99527	174	99602	38	99654	374	99694	432	99788	484
99439	440	99531	409	99603	38	99655	496	99695	433	99789	485
99445	196	99532	409	99604	39	99656	496	99696	433	99791	487
99446	196	99539	186	99605	39	99659	493	99697	419	99792	485

NUMBER NUMMER NUMÉRO	PAGE SEITE PAGE	NUMBER NUMMER NUMÉRO	PAGE SEITE PAGE	NUMBER NUMMER NUMÉRO	PAGE SEITE PAGE	NUMBER NUMMER NUMÉRO	PAGE SEITE PAGE	NUMBER NUMMER NUMÉRO	PAGE SEITE PAGE	NUMBER NUMMER NUMÉRO	PAGE SEITE PAGE
99793	492	99855	234	900071	37	900113	78	900169	726	900325	594
99794	825	99856	234	900072	37	900114	84	900171	726	900328	490
99795	234	900001	88	900076	41	900115	84	900172	727	900329	490
99796	236	900002	88	900077	41	900116	21	900173	726	900331	744
99797	236	900005	90	900078	41	900128	91	900174	417	900332	744
99798	236	900006	90	900079	40	900129	91	900175	417	900333	744
99799	322	900019	44	900081	40	900134	793	900176	265	900334	813
99801	322	900021	44	900082	40	900135	793	900177	264	900335	550
99802	322	900022	63	900083	90	900141	819	900178	265	900336	92
99803	323	900023	63	900084	88	900142	819	900179	265	900337	92
99804	323	900024	63	900085	89	900143	436	900185	521	900338	92
99805	323	900025	62	900086	54	900144	176	900186	452	900339	93
99806	262	900044	70	900087	55	900145	176	900187	788	900341	288
99807	262	900045	70	900088	54	900146	176	900188	518	900342	288
99808	263	900046	70	900089	54	900147	177	900195	353	900343	606
99809	262	900047	71	900091	57	900148	177	900196	353	900346	439
99811	403	900048	71	900092	56	900149	550	900302	506	900347	202
99817	490	900049	72	900093	56	900151	210	900304	277	900348	202
99818	418	900051	72	900094	56	900152	210	900305	276	900349	235
99819	413	900052	72	900095	73	900153	210	900306	277	900351	308
99821	413	900053	73	900099	76	900154	211	900307	277	900352	308
99822	796	900054	64	900101	76	900157	519	900313	454	900353	308
99824	812	900055	64	900102	76	900158	437	900314	814	900354	309
99825	812	900056	64	900103	82	900159	437	900315	46	900355	510
99828	831	900057	66	900104	82	900161	448	900316	46	900356	510
99829	831	900058	66	900105	80	900162	448	900317	46	900357	510
99831	832	900059	66	900106	80	900163	448	900318	47	900358	815
99832	832	900061	67	900107	81	900164	254	900319	49	900359	512
99838	676	900062	67	900108	86	900165	260	900321	49	900361	520
99839	676	900067	36	900109	87	900166	260	900322	48	900362	457
99853	676	900068	36	900111	78	900167	260	900323	48	900363	631
99854	677	900069	36	900112	78	900168	261	900324	48	900364	633

NUMBER NUMMER NUMÉRO	PAGE SEITE PAGE	NUMBER NUMMER NUMÉRO	PAGE SEITE PAGE	NUMBER NUMMER NUMÉRO	PAGE SEITE PAGE	NUMBER NUMMER NUMÉRO	PAGE SEITE PAGE	NUMBER NUMMER NUMÉRO	PAGE SEITE PAGE	NUMBER NUMMER NUMÉRO	PAGE SEITE PAGE
900365	635	900409	52	900465	320	900503	212	900561	499	900626	833
900366	634	900411	53	900466	320	900504	213	900562	313	900628	833
900367	502	900412	53	900467	320	900505	213	900563	312	900631	316
900369	636	900419	483	900468	321	900506	355	900564	313	900632	316
900375	605	900421	488	900469	321	900507	355	900565	313	900633	317
900376	203	900422	489	900471	482	900508	355	900566	51	900634	178
900377	203	900423	489	900472	417	900509	509	900567	50	900635	178
900378	203	900424	489	900475	653	900511	280	900571	498	900636	89
900379	456	900425	436	900476	654	900512	280	900572	498	900661	713
900381	456	900426	436	900477	53	900513	768	900573	498	900662	713
900382	709	900428	621	900478	42	900514	769	900596	482	900663	713
900383	709	900429	434	900479	42	900515	769	900597	482	900686	257
900384	709	900431	434	900481	58	900516	768	900598	543	900687	258
900385	217	900432	689	900482	60	900517	606	900599	543	900693	710
900386	217	900433	689	900483	58	900518	606	900601	564	900694	710
900387	24	900434	689	900484	58	900519	257	900602	565	900695	710
900388	24	900435	517	900485	60	900521	259	900603	492	900696	458
900391	24	900436	743	900486	59	900522	257	900604	492	900697	458
900392	25	900437	743	900487	59	900523	259	900605	546	900701	161
900393	792	900438	743	900488	244	900524	507	900606	546	900702	26
900394	792	900439	30	900489	244	900525	592	900607	544	900711	703
900395	280	900441	30	900491	244	900526	592	900608	544	900712	703
900396	815	900442	30	900492	245	900528	839	900609	545	900713	703
900398	42	900443	517	900493	245	900529	839	900611	545	900714	733
900399	404	900444	453	900494	256	900549	354	900612	551	900715	733
900401	408	900446	452	900495	256	900551	354	900613	551	900716	733
900402	408	900457	786	900496	258	900552	817	900614	519	900717	593
900403	816	900458	787	900497	259	900553	514	900615	655	900721	505
900404	43	900459	786	900498	552	900554	514	900616	654	900722	33
900406	31	900461	786	900499	552	900555	514	900617	656	900723	33
900407	31	900463	561	900501	552	900558	499	900618	656	900724	33
900408	52	900464	561	900502	212	900559	499	900619	631	900728	50

NUMBER NUMMER NUMÉRO	PAGE SEITE PAGE	NUMBER NUMMER NUMÉRO	PAGE SEITE PAGE	NUMBER NUMMER NUMÉRO	PAGE SEITE PAGE	NUMBER NUMMER NUMÉRO	PAGE SEITE PAGE
900729	50	900826	521	900865	519	900909	250
900731	266	900828	420	900866	429	900916	315
900732	266	900829	421	900867	429	900917	314
900733	267	900831	216	900868	794	900918	315
900734	267	900832	216	900869	794	900919	315
900735	267	900833	457	900871	595	900923	785
900736	515	900834	457	900872	270	900924	785
900738	215	900835	438	900873	270	900925	785
900739	214	900836	438	900874	273	900926	251
900741	215	900837	516	900875	272	900928	653
900742	215	900838	516	900876	272	900929	653
900758	69	900839	769	900877	273	900945	818
900759	69	900841	27	900878	23	900946	818
900761	69	900842	27	900879	23	900947	319
900762	68	900843	268	900881	27	900948	318
900763	96	900844	629	900882	26	900949	319
900764	97	900845	629	900883	26	900951	318
900765	96	900846	634	900892	241	900952	480
900766	97	900847	220	900893	357	900953	481
900792	505	900848	515	900894	357	900954	481
900795	560	900849	461	900895	385	900955	481
900796	560	900853	28	900896	423	900956	834
900797	562	900854	29	900897	423	900957	834
900798	397	900855	28	900898	817	900958	834
900799	397	900856	29	900901	219	900975	407
900801	397	900857	562	900902	219	900976	407
900812	356	900858	199	900903	219	900977	407
900813	356	900859	199	900904	218	901015	319
900814	817	900861	198	900905	218		
900823	811	900862	199	900906	251		
900824	811	900863	565	900907	250		
900825	521	900864	565	900908	250		



NOTES

NOTIZEN

NOTES

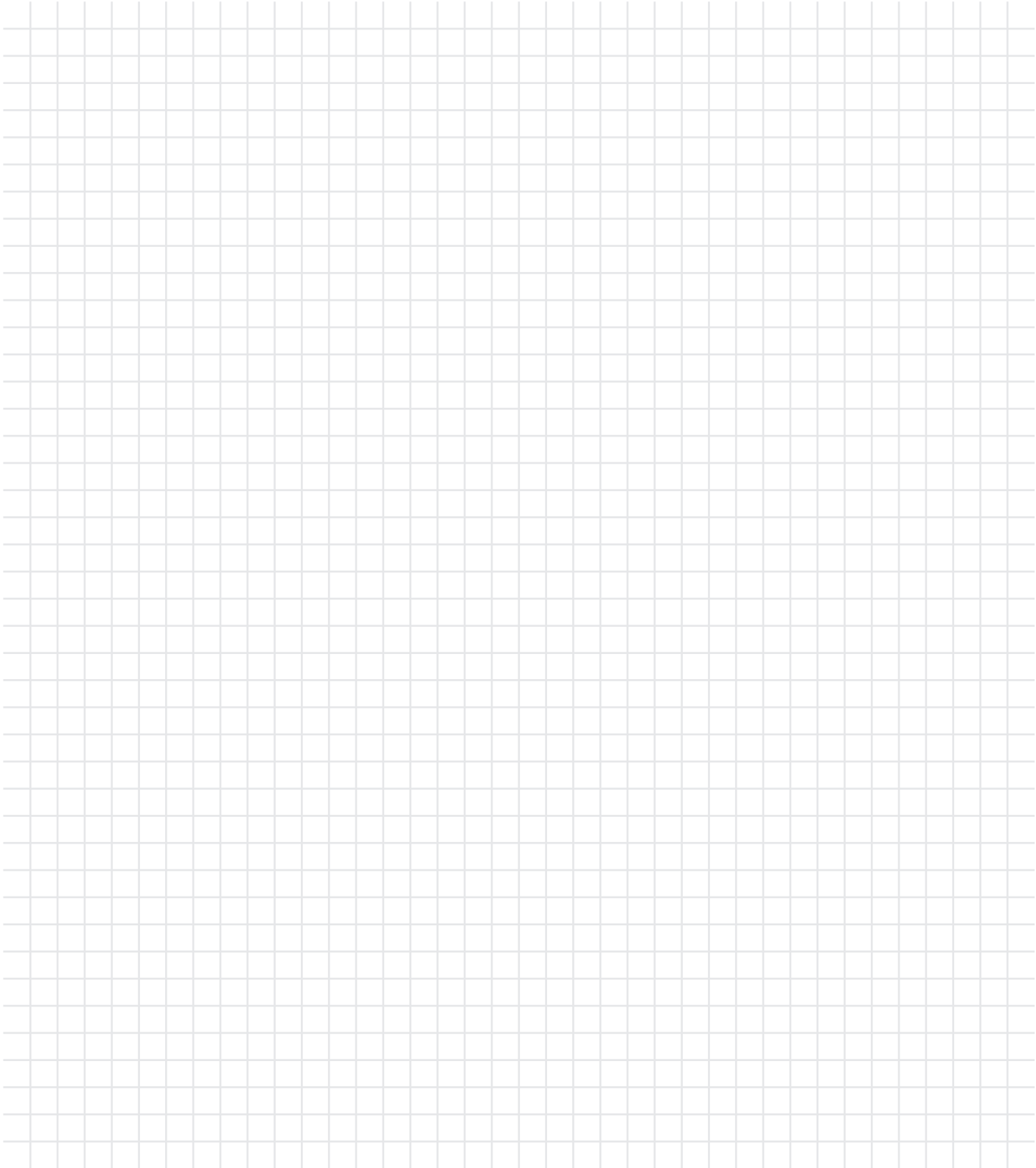

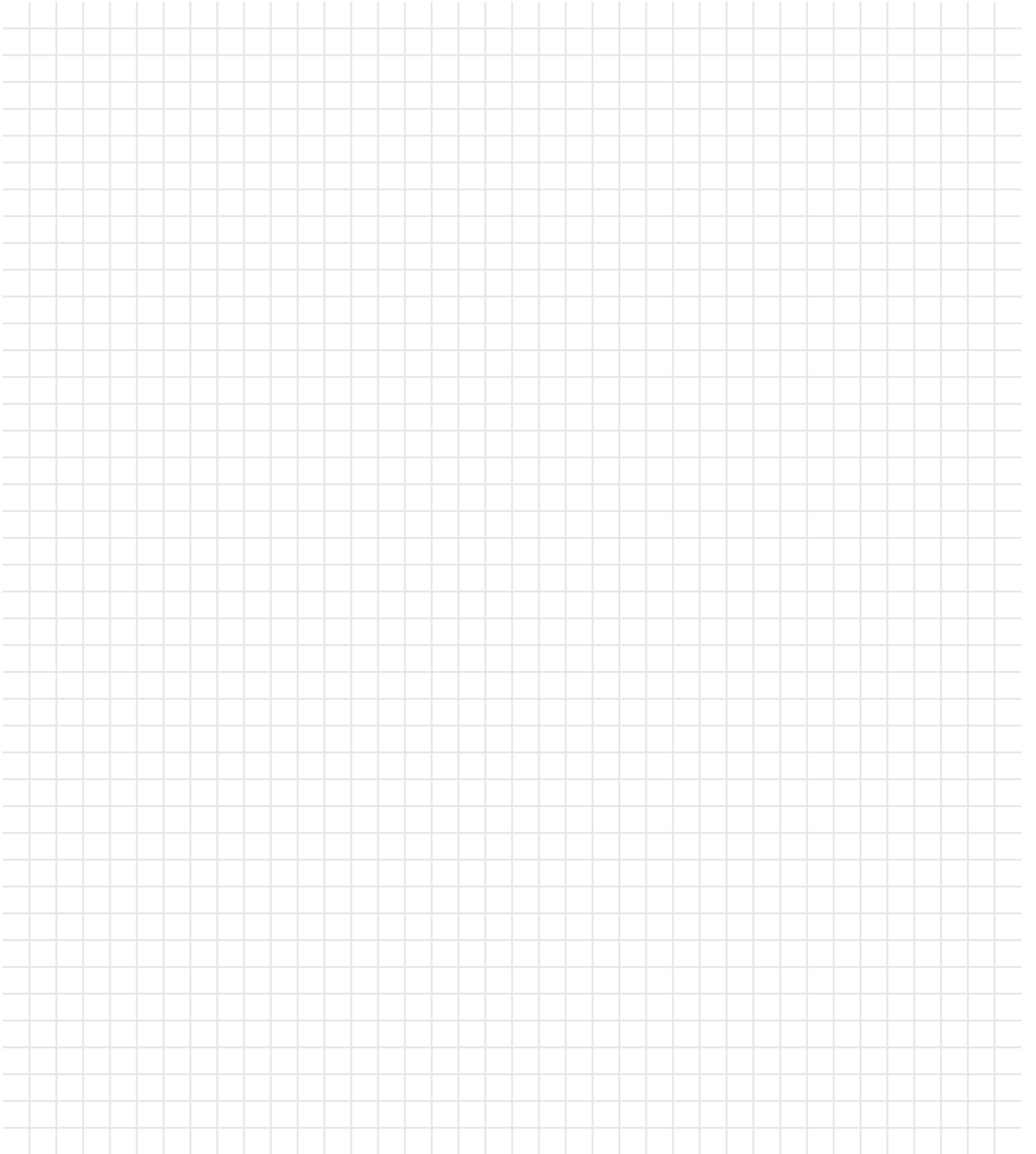

All previous catalogues and price lists are no longer valid with the issue of this catalogue. Errors, misprints, model and price changes and technical modifications are reserved. We deliver based on our terms of delivery and payment. Our products comply with the European light norm EN60598. Products with the ENEC test mark are conforming to the guide line 2006/95/EG. Products with additional safety remarks (e.g protection class, IP) are identified within the product family with the relevant symbol and number. The content of this catalogue is protected under copyright law for EGLO Leuchten GmbH. All rights reserved. Our specific written consent must be obtained before using any illustrations and texts. The pictures are 4C prints and may differ from the original.

The product pictures and ambiances in this catalogue can deviate from reality, and they do not necessarily concur with the usual application of the product. EGLO does not assume liability for the correctness, completeness or the application depiction of the products and/or the product information.

Design, layout and composition: EGLO GmbH, A-6136 Pill - AUSTRIA

Print: Samson Druck GmbH, 5581 St. Margarethen - AUSTRIA

Pictures: EGLO, Adobe Stock, istockphoto.com

Mit diesem Katalog verlieren alle vorhergehenden Kataloge und Preislisten ihre Gültigkeit. Irrtümer, Druckfehler, Modell- und Preisänderungen sowie technische Änderungen vorbehalten. Wir liefern zu unseren Liefer- und Zahlungsbedingungen. Unsere Produkte entsprechen der europäischen Leuchtnorm EN 60598. Produkte mit dem ENEC Prüfzeichen sind konform mit der Richtlinie 2006/95/EG. Produkte mit weiteren Sicherheitshinweisen (zB. Schutzklasse, IP) sind mit Symbol und Zahl bei der Produktfamilie ausgezeichnet. Der Inhalt dieses Kataloges ist für die EGLO Leuchten GmbH urheberrechtlich geschützt. Alle Rechte sind vorbehalten. Bilder und Texte dürfen nicht ohne vorherige ausdrückliche, schriftliche Genehmigung verwendet werden. Die Abbildungen sind 4C Drucke und können vom Original abweichen.

Die Katalogbilder und die gezeigten Darstellungen der Produkte können von der Wirklichkeit abweichen und nicht den üblichen Produktanwendungen entsprechen. EGLO übernimmt keine Haftung für die Richtigkeit, Vollständigkeit und Anwendungsdarstellung der Produkte und Produktinformationen.

Gestaltung, Layout und Satz: EGLO GmbH, A-6136 Pill - AUSTRIA

Druck: Samson Druck GmbH, 5581 St. Margarethen - AUSTRIA

Bilder: EGLO, Adobe Stock, istockphoto.com

Le présent catalogue remplace tous les catalogues et tarifs précédents. Sous réserve d'erreurs, de fautes d'impression, de modification des modèles et de changement de prix et de technique. Nous livrons sur la base de nos conditions de livraison et de paiement. Nos produits sont conformes aux normes européennes EN 60598 et portent le marquage CE. Les produits portant la marque ENEC sont conformes à la Directive 2006/95/EG. Les produits portant d'autres indications de sécurité (par exemple classe de protection, IP) sont identifiés par le symbole et le nombre correspondants dans la famille de produits.

Le contenu du présent catalogue est protégé pour la société EGLO Leuchten GmbH par un copyright. Tous droits réservés. Toute reproduction d'images et du texte est interdite sans autorisation explicite par écrit préalable. Les images sont imprimées en 4C et peuvent différer de l'original.

Les images des produits et les ambiances dans le catalogue peuvent dévier de la réalité et ne sont pas nécessairement en ligne avec l'usage habituel du produit. EGLO n'engage pas sa responsabilité sur la justesse des images et sur les informations relatives à l'usage pouvant être fait des produits.

Conception, maquette et composition: EGLO GmbH, A-6136 Pill - AUSTRIA

Presse: Samson Druck GmbH, 5581 St. Margarethen - AUSTRIA

Images: EGLO, Adobe Stock, istockphoto.com

06-2023



EGLO Leuchten GmbH
Heiligkreuz 22
A-6136 Pill
Austria
Tel. +43 (0) 5242 6996
Fax +43 (0) 5242 6996-972
info@eglo.com
www.eglo.com

KAT-23

my light | my style