



EGLO
my light | my style



2023/24

INTERIOR LIGHTING

WOHNRAUMLEUCHTEN
LUMINAIRES INTÉRIEURS



Dear business partners and loyal EGLO friends,

We are thrilled to present our new main EGLO catalogue. With this catalogue, we want to showcase our extensive collection of high-quality luminaires, designed with meticulous attention to detail and a focus on design and quality.

At EGLO, environmental sustainability is a top priority. We ensure that our luminaires are produced in a way that conserves resources as much as possible. Additionally, the durability of our products is of great importance to us. We want to do our part to guarantee you find beautiful yet sustainable products for your home with EGLO. Many of our luminaires feature energy-saving LED technology, which helps you save on electricity costs and protect the environment.

We take pride in offering a wide range of high-quality luminaires at affordable prices, to ensure you find the perfect fit for your living needs in our catalogue.

We hope you enjoy browsing through our catalogue and look forward to helping you choose the perfect luminaire.

Geschätzte Geschäftspartner*innen, treue EGLO Freund*innen,

wir freuen uns sehr, Ihnen den neuen Hauptkatalog von EGLO präsentieren zu können. Mit diesem Katalog möchten wir Ihnen unsere umfangreiche Kollektion von hochwertigen Leuchten vorstellen, die wir mit viel Liebe zum Detail und einem besonderen Fokus auf Design und Qualität entworfen haben.

Auch das Thema Umwelt spielt bei EGLO eine wichtige Rolle. Wir achten darauf, dass unsere Leuchten möglichst ressourcenschonend produziert werden. Darüber hinaus ist uns die Langlebigkeit unserer Produkte wichtig. Wir möchten unseren Beitrag dazu leisten, dass Sie nicht nur schöne, sondern auch nachhaltige Produkte bei uns finden. Viele unserer Leuchten verfügen über energiesparende LED-Technologie, die Ihnen nicht nur hilft Stromkosten zu sparen, sondern auch die Umwelt schont.

Wir sind stolz darauf, Ihnen eine große Auswahl an hochwertigen Leuchten zu fairen Preisen anbieten zu können und sind uns sicher, dass Sie in unserem Katalog das perfekte Angebot für Ihre Wohnbedürfnisse finden werden.

Wir wünschen Ihnen viel Spaß beim Durchblättern unseres Katalogs und freuen uns darauf, Ihnen bei der Wahl der passenden Leuchte behilflich zu sein.

Chers partenaires commerciaux*, fidèles amis d'EGLO*,

Nous sommes très heureux de vous présenter le nouveau catalogue principal d'EGLO. Avec ce catalogue, nous souhaitons vous présenter notre vaste collection de luminaires haut de gamme, que nous avons conçus avec un grand souci du détail et un accent particulier sur le design et la qualité.

Le thème de l'environnement joue également un rôle important chez EGLO. Nous veillons à ce que nos luminaires soient produits en préservant le plus possible les ressources. De plus, la longévité de nos produits est importante pour nous. Nous souhaitons apporter notre contribution pour que vous trouviez chez nous, non seulement de beaux produits, mais aussi des produits durables. Beaucoup de nos luminaires sont dotés de la technologie LED à faible consommation d'énergie, qui vous permet non seulement d'économiser des frais d'électricité, mais aussi de préserver l'environnement.

Nous sommes fiers de pouvoir vous proposer un grand choix de luminaires de qualité à des prix équitables et nous sommes certains que vous trouverez dans notre catalogue l'offre parfaite pour vos besoins en matière d'habitat.

Nous vous souhaitons beaucoup de plaisir à feuilleter notre catalogue et nous nous réjouissons de pouvoir vous aider à choisir le luminaire qui vous convient.

Mag. René Tiefenbacher
CEO EGLO Group

CONTENT

INHALT
CONTENU



	CONNECT.Z 10 CONNECT.Z CONNECT.Z		SPOT & TRACK LUMINAIRES 678 SPOT- & SCHIENENLEUCHTEN SPOT & LUMINAIRES SUR RAIL
	EGLO ACCESS 112 EGLO ACCESS EGLO ACCESS		CLIP & PLUG LUMINAIRES 772 KLEMM- & STECKERLEUCHTEN LUMINAIRES À PINCE & SUR PRISE
	LIGHTING FAMILIES 130 FABRIC LUMINAIRES STOFFLEUCHTEN LUMINAIRES À TEXTIL		TABLE & FLOOR LUMINAIRES 780 TISCH- & STEHLEUCHTEN LUMINAIRES DE TABLE & LAMPADAIRES
	LIGHTING FAMILIES 206 WOOD LUMINAIRES HOLZLEUCHTEN LUMINAIRES À BOIS		OFFICE TABLE & FLOOR LUMINAIRES 826 OFFICE TISCH- & STEHLEUCHTEN LUMINAIRES DE TABLE & LAMPADAIRES À BUREAU
	LIGHTING FAMILIES 228 STANDARD LUMINAIRES STANDARD LEUCHTEN LUMINAIRES STANDARD		CHILDREN LUMINAIRES 862 KINDERLEUCHTEN LUMINAIRES POUR ENFANTS
	LIGHTING FAMILIES 336 GLASS CHANDELIERS LEUCHTENFAMILIEN FAMILIES DE LUMINAIRES		KITCHEN & FUNCTION LUMINAIRES 868 KÜCHEN- & FUNKTIONSLAUCHTEN LUMINAIRES FONCTIONNELS & DE CUISINE
	HANGING & PENDANT LUMINAIRES 346 HÄNGE- & PENDELLEUCHTEN LUMINAIRES SUSPENSIONS		ACCESSORIES 876 ZUBEHÖR ACCESSOIRES
	WALL & CEILING LUMINAIRES 472 WAND- & DECKENLEUCHTEN APPLIQUES & PLAFONNIERS		INDEX & LEGEND 884 INDEX & ERKLÄRUNG INDEX & LÉGENDE
	BATH & MIRROR LUMINAIRES 616 BAD- & SPIEGELLEUCHTEN LUMINAIRES DE BAIN & MIROIR		

EGLO TREND HIGHLIGHTS 2023/24

The EGLO design team has once again drawn on current mega-trends as a source of inspiration for the 2023/24 season. The new EGLO products' use of shape and colour, choice of materials, and overall aesthetic harmonise perfectly with both contemporary and future living trends. Minimalism and the increasingly popular use of materials and colours such as brass and earth tones have had a particularly strong influence on this season's luminaire designs.

Auf Basis der Megatrends hat sich das Design-Team von EGLO auch für die Saison 2023/24 inspirieren lassen. Mit ihrer Formsprache, Farbgebung sowie den verwendeten Materialien fügen sich die EGLO Neuheiten in die aktuellen wie auch zukünftigen Wohntrends ein. Der Trend des Minimalismus sowie die Verwendung von Materialien und Farben wie Messing und Erdtöne haben auf die aktuellen Leuchten-Designs besonderen Einfluss genommen.

Sur la base des mégatendances, l'équipe de conception EGLO a également été inspirée pour la saison 2023/24. Avec leur langage visuel, leur palette de couleurs et les matériaux utilisés, les innovations EGLO s'intègrent dans les tendances de la vie d'aujourd'hui et de demain. La tendance au minimalisme et l'utilisation de matériaux et de couleurs tels que le laiton et les tons de terre ont eu une influence particulière sur les conceptions actuelles de nos luminaires.

Minimalism – The art of less, the conscious reduction of shapes and colours to the bare essentials, is reflected in our luminaires. Clear and simple shapes and plain colours combine to create a calm atmosphere, in keeping with the maxim "less is more". Warm grey tones and timber elements give the room a welcoming touch, adding atmospheric highlights and offering a harmonious stage for your entire living space to work its magic without any distractions.

Minimalismus – Der bewusste Verzicht und die Kunst, Form und Farbe auf ein Minimum zu reduzieren, spiegelt sich in unseren Leuchten wider. Frei nach dem Prinzip „Weniger ist mehr“ sorgen klare und einfache Formen sowie schlichte Farben für eine ruhige Atmosphäre. Für die nötige Gemütlichkeit setzen warme Grautöne oder Holzelemente stimmungsvolle Akzente und bieten eine harmonische Bühne, um den gesamten Raum ganz ohne Ablenkung für sich wirken zu lassen.

Le minimalisme – Nos lampes reflètent un renoncement volontaire et l'art de réduire au minimum formes et couleurs. Selon le principe « faire plus avec moins », des formes claires et simples et des couleurs unies créent une atmosphère paisible. Pour le confort, des tons gris chauds ou des éléments en bois mettent en place une ambiance agréable et un décor harmonieux pour vous permettre de travailler dans une pièce sans aucune distraction.



ALMUDAINA



CENCIARA

Brass – Brass so popular back in the 50s and 60s, is currently enjoying a new wave of popularity. Skilfully paired with contrasting materials, the gleaming metallic hues of brass bring a touch of luxury to living spaces without appearing old-fashioned. We have incorporated the high-quality material into our new luminaire models and combined it with diverse other materials to create captivating modern designs that can be integrated into a variety of interiors, from urban to classical to minimalist.

Messing – Der bereits in den 50er und 60er Jahren so populäre Messingtrend erfreut sich aktuell an neuer Beliebtheit. Gekonnt kombiniert und kontrastreich in Szene gesetzt, bringt Messing mit seinem strahlenden Metallton einen Hauch von Luxus in die Wohnräume, ohne altmodisch zu wirken. Das hochwertige Material haben wir in unsere neuen Leuchten-Modelle einfließen lassen und in Kombination mit verschiedenen Materialien charmante und moderne Designs geschaffen, die sich in unterschiedliche Einrichtungen von urban über klassisch bis hin zu minimalistisch integrieren lassen.

Le lait – La tendance du lait, déjà si populaire dans les années 50 et 60, est actuellement à nouveau au goût du jour. Habilement combiné et mis en scène avec de riches contrastes, le lait avec sa teinte métallique brillante apporte une touche de luxe aux espaces de vie sans paraître démodé. Nous avons incorporé ce matériau de haute qualité dans nos nouveaux modèles de luminaires et, en combinaison avec divers matériaux, avons créé des designs charmants et modernes qui peuvent être intégrés à des aménagements différents, qu'ils soient notamment urbains, classiques ou encore minimalistes.

Warm earth tones – The very popular back-to-nature trend has also brought about a significant shift in the field of design. More and more people have been embracing a return to nature in recent years and the associated use of natural materials has also left its mark on the world of colour, heralding the rise of brown as the new black. The colour brown in all its many facets can be beautifully paired with almost any other colour and, thanks to its diverse earthy tones, not only lends our living spaces a touch of naturalness, but also conveys a sense of warmth and comfort. Combining this year's popular colour trend with wood and brass elements helps accentuate its distinctive appeal.

Warme Erdtöne – Der starke Trend hin zu mehr Natürlichkeit hat auch im Design einen bedeutsamen Wandel bewirkt. Die in den letzten Jahren deutlich an Bedeutung gewonnene Verbundenheit zur Natur und die damit einhergehende Verwendung von natürlichen Materialien hat auch die Farbwelt geprägt und lässt Braun als das neue Schwarz triumphieren. Braun in all seinen Facetten lässt sich hervorragend kombinieren und verleiht unseren Wohnräumen durch seine vielfältigen Erdtöne nicht nur einen Hauch von Natürlichkeit, sondern vermittelt Gemütlichkeit und Behaglichkeit gleichermaßen. Die Kombination mit Holz oder Messing verleiht der neuen Trendfarbe ihre besonderen Akzente.

Des tons chauds de terre – La forte tendance vers un caractère plus naturel a également entraîné un changement significatif dans notre conception. Le lien avec la nature, qui a grandement gagné en importance ces dernières années, et l'utilisation associée de matériaux naturels ont également façonné l'univers des couleurs : c'est ainsi que le brun a détrôné le noir. Le brun sous toutes ses facettes peut être parfaitement combiné et, avec ses divers tons de terre, non seulement donner à nos salons une touche naturelle, mais aussi procurer confort et bien-être dans le même temps. La combinaison de cette nouvelle couleur tendance avec le bois ou le laiton lui confère ses accents si particuliers.



PODERE

Look out for this Logo!

Achten Sie auf das Logo!

Soyez attentif au logo !

What is a forest?

A peaceful oasis, the green lungs of the world, and an adventure playground for children of all ages!

The Forest Stewardship Council® (FSC®) is a global, not-for-profit organisation dedicated to the promotion of responsible forest management worldwide. The FSC® defines standards for responsible forest management in accordance with established principles that are developed and supported by stakeholders from the environmental, social and economic spheres. For more information, please see www.fsc.org.

Was ist Wald für uns?

Eine Oase der Ruhe, die Lunge der Welt oder ein Abenteuerspielplatz für große und kleine Kinder!

Das Forest Stewardship Council® (FSC®) ist eine globale, gemeinnützige Organisation, mit dem Zweck verantwortungsvolle Waldbewirtschaftung weltweit zu fördern. FSC® definiert Standards für eine verantwortungsvolle Waldbewirtschaftung nach festgelegten Prinzipien, die von Interessenvertretern aus den Bereichen Umwelt, Soziales und Wirtschaft entwickelt und getragen werden. Für weitere Informationen besuchen Sie www.fsc.org.

Que représente la forêt pour nous ?

Une oasis de calme, les poumons du monde ou un terrain de jeu d'aventure pour les enfants de tous âges !

Le Forest Stewardship Council® (FSC®) est une organisation internationale à but non lucratif dont le but est de promouvoir une gestion forestière responsable dans le monde entier. Le FSC® définit des normes de gestion forestière responsable selon des principes établis qui sont développés et soutenus par les parties prenantes des secteurs environnemental, social et économique. Pour plus d'informations, veuillez consulter www.fsc.org.

Look out for FSC® -certified products!
Achten Sie auf FSC® -zertifizierte Produkte!
Soyez attentif aux produits certifiés FSC® !



The mark of
responsible forestry

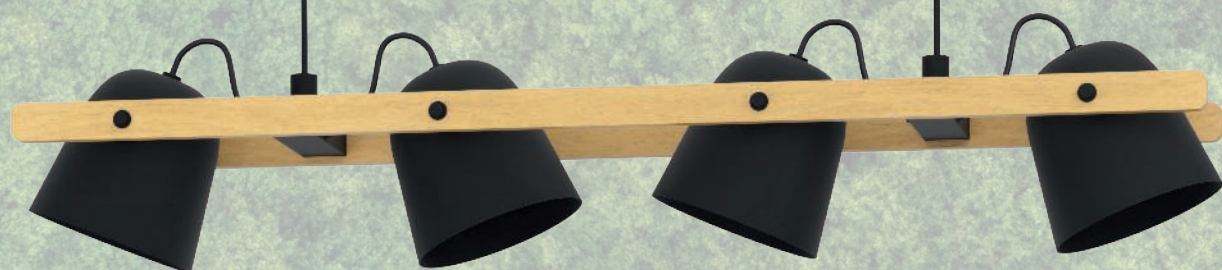

900883



DIGITAL CATALOGUE



This year, we are also making the main catalogue in front of you available online, including lots of extra information and additional features. In addition to search and filter functions, the online catalogue includes extensive product photos, videos and additional information, complementing the paper edition wonderfully. Take a look at

<https://catalogue.eglo.com>

In diesem Jahr präsentieren wir den vor Ihnen liegenden Hauptkatalog wieder als Online-Katalog mit vielen Zusatzinformationen und zusätzlichen Features. Neben Such- und Filterfunktionen bietet der Online-Katalog mit reichhaltigen Produktabbildungen, Videos und zusätzlichen Informationen einen erheblichen Mehrwert zur gebundenen Ausgabe. Klicken Sie sich rein unter

<https://catalogue.eglo.com>

Cette année, nous présentons à nouveau une version en ligne du catalogue général. Cette version contient de nombreuses informations et fonctionnalités complémentaires. Outre les fonctionnalités de recherche et de filtrage, le catalogue en ligne propose de nombreuses illustrations de produits, des vidéos et des informations complémentaires : une valeur ajoutée considérable par rapport à la version papier. Cliquez ici pour le découvrir :

<https://catalogue.eglo.com>



EGLO CONNECT.Z

EGLO CONNECT.Z
EGLO CONNECT.Z

EN EGLO CONNECT.Z

Discover the smart world of light. You will find everything about control options, functions and beneficial use in everyday life on the following pages. Let yourself be surprised by the EGLO connect.z range.

DE EGLO CONNECT.Z

Entdecke die smarte Welt des Lichtes. Alles über Steuerungsmöglichkeiten, Funktionen und die vorteilhafte Anwendung im Alltag finden Sie auf den folgenden Seiten. Lassen Sie sich vom EGLO connect.z Sortiment überraschen.

FR EGLO CONNECT.Z

Découvrez le monde intelligent de la lumière. Vous trouverez tout sur les options de contrôle, les fonctions et l'utilisation bénéfique dans la vie quotidienne dans les pages suivantes. Laissez-vous surprendre par la gamme EGLO connect.z.

connect.2

Discover the smart world



















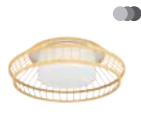





























 zigbee

 Bluetooth®



OVERVIEW

EGLO CONNECT.Z
EGLO CONNECT.Z
EGLO CONNECT.Z

 CONNECT-Z 21	 CONNECT-Z SENSOR 21	 CONNECT-Z SWITCH 21	 ANDREAS-Z 23	 ANCHORENA-Z 24-25	 KOKOMO-Z 26	 HORNWOOD-Z 26	 YUKU-Z 27
 PORTICO-Z 27	 BARBANO-Z 28-29	 ROMAO-Z 30	 TOLLOS-Z 31	 GINESTRONE-Z 33	 SALVILANAS-Z 34-35	 MARGHERA-Z 36-37	 SIMOLARIS-Z 38-39
 FRAIOLI-Z 40-41	 LOBINERO-Z 42	 ZILLERIO-Z 42	 ANDABAIA-Z 43	 TABIANO-Z 44	 LOMALTAS-Z 45	 PARANDAY-Z 46-47	 PARRAPOS-Z 48-49
 CALAGRANO-Z 50-51	 MONTEMORE- LOS-Z 52-53	 GENOVESE-Z 53	 ROVITO-Z 54-57	 PADROGIANO-Z 58-60	 SAVATARILA-Z 62-63	 SALITERAS-Z 63	 TURCONA-Z 64-67
 SARSINA-Z 68-69	 SALOBRENA-Z 70-73	 HERRORA-Z 74	 FUEVA-Z 76-87	 TOTARI-Z 88-89	 LANCIANO-Z 90	 SILERAS-Z 91	 TELIMBELA-Z 92-93
 CAMINALES-Z 94	 SALICETO-Z 95	 CAROSSO-Z 96-97	 LED STRIPE-Z 98-99	 LM_LED_E27 100-101	 LM_LED_E14 101	 LM_LED_GU10 101	



This product is available in different colors and shapes. / Dieser Artikel ist in unterschiedlichen Farben und Formen verfügbar. / Cet article est disponible en différentes couleurs et formes.



connect.z combines two control technologies in one system

connect.z vereint zwei Steuerungstechnologien in einem System

connect.z réunit deux technologies de commande au sein d'un même système



ZigBee is far and away the most widely used standard in the smart home world.

ZigBee ist der am weitesten verbreitete Standard in der Smart Home Welt.

ZigBee est le protocole le plus répandu au monde dans le domaine du Smart Home.

ADVANTAGES :

- › Mesh network
- › Direct connection with Amazon Echo and Google Home
- › Compatible with products from different manufacturers
- › High level of security
- › Easy setup
- › Energy efficient

VORTEILE:

- › Mesh-Netzwerk
- › Direkte Verbindung mit Amazon Echo und Google Home
- › Herstellerübergreifend kompatibel
- › Hohe Sicherheit
- › Einfache Einrichtung
- › Energieeffizient

AVANTAGES:

- › Réseau maillé
- › Connexion directe à Amazon Echo et Google Home
- › Compatible indépendamment du fabricant
- › Sécurité élevée
- › Installation facile
- › Économe en énergie

connect.2



Bluetooth is an established standard in the digital world.
Bluetooth ist ein etablierter Standard in der digitalen Welt.
Bluetooth est un standard de communication reconnu dans le monde numérique.

ADVANTAGES:

- › Local & secure network
- › Protocol is mainly audio (low debit)
- › Mesh network: Elements are receivers and senders
- › Easy setup
- › Usable offline
- › Energy efficient

VORTEILE:

- › Lokales & sicheres Netzwerk Protokoll hauptsächlich Audio (Low Debit)
- › Mesh-Netzwerk: Elemente sind Empfänger und Sender
- › Einfache Einrichtung
- › Offline nutzbar
- › Energieeffizient

AVANTAGES:

- › Réseau local et sûr
- › Protocole essentiellement audio (bas débit)
- › Réseau maillé : les éléments sont l'émetteur et le récepteur
- › Installation facile
- › Utilisable hors-ligne
- › Économe en énergie

Light up your world!

Bringen Sie Licht in Ihren Alltag!
Illuminez votre quotidien !



connect.z offers a wide range of lamps and lighting equipment. Select products from the following options according to your needs:
connect.z bietet ein großes Sortiment an Leuchten und Leuchtmitteln. Wählen Sie die Produkte ganz nach Ihren Bedürfnissen aus folgenden Varianten:
connect.z propose une large gamme de luminaires et d'ampoules. Sélectionnez les produits en fonction de vos besoins parmi les variantes suivantes :

Warm White

Neutral White

Tunable White

Individual light from 50,000 white tones.
Individuelles Licht aus 50.000 Weißtönen.
Luminaire individuel à 50 000 tons de blanc.

TW + RGB Colors

Diverse lighting selection from 50,000 white tones and 16 million colours.
Vielseitige Lichtauswahl aus 50.000 Weißtönen und 16 Mio. Farben.
Sélection étendue de luminaires à 50 000 tons de blanc et 16 millions de couleurs.

Enjoy relaxing moments!
Genießen Sie entspannte Momente!
Profitez de moments de détente !

Stay focussed & efficient!
Bleiben Sie konzentriert & leistungsfähig!
Restez concentré(e) et performant(e) !

Start the day fresh every morning!
Starten Sie jeden Morgen frisch in den Tag!
Commencez la journée du bon pied !

Create the perfect atmosphere!
Kreieren Sie Ihr perfektes Ambiente!
Créez votre ambiance parfaite !



Enjoy many useful convenience features:

Es erwarten Sie viele nützliche Komfortfunktionen:
De nombreuses fonctionnalités utiles vous attendent pour votre confort :



TIMERS AND CALENDARS / TIMER UND ZEITPLÄNE/ MINUTERIE ET CALENDRIER

Make your daily life easier with timers and calendars.
Wake up relaxed with the simulated sunrise.

Unterstützen Sie Ihren Alltag mit Timern und Zeitplänen. Entwickeln Sie eigene Lichtroutinen und machen Sie Ihr Leben leichter.

Facilitez-vous la vie à l'aide de la fonction minuterie et calendrier.
Réveillez-vous en douceur grâce au simulateur de lever de soleil.



LIGHT ALARM CLOCK / LICHTWECKER/ REVEIL LUMINEUX

You'd rather not start your day in a bad mood? Wake up relaxed with the simulated sunrise.

Keine Lust mit schlechter Laune in den Tag zu starten? Entspannt aufwachen mit dem simulierten Sonnenaufgang.

Pas envie de commencer la journée de mauvaise humeur ? Réveillez-vous en douceur grâce au simulateur de lever de soleil.



DISCO FUNCTION/MODE / DISCOFUNKTION/MODUS/ FONCTION/MODE DISCO

For the perfect party mood, the disco function synchronises the light to the beat of your favourite songs.

Für die perfekte Partystimmung schaltet die Discofunktion das Licht passend zum Beat Ihres Lieblingssongs.

Pour une ambiance festive parfaite, la fonction disco enclenche le luminaire au rythme de votre chanson préférée.



PRESENCE SIMULATOR / ANWESENHEITSSIMULATION/ SIMULATEUR DE PRESENCE

Protect your home with the convenient presence simulator. Variable time intervals allow the system to turn the lights on and off to simulate your presence at home and deter unwanted guests.

Schütze Sie Ihr Zuhause mit der komfortablen Anwesenheitssimulation. Dank variabler Zeitintervalle simuliert das System durch Ein- und Ausschalten der Beleuchtung die Anwesenheit im Haus und schreckt so ungebetene Gäste ab.

Protégez votre domicile à l'aide du très pratique simulateur de présence. Le système simule votre présence en allumant et en éteignant les lumières à intervalles variables et décourage ainsi les invités indésirables.

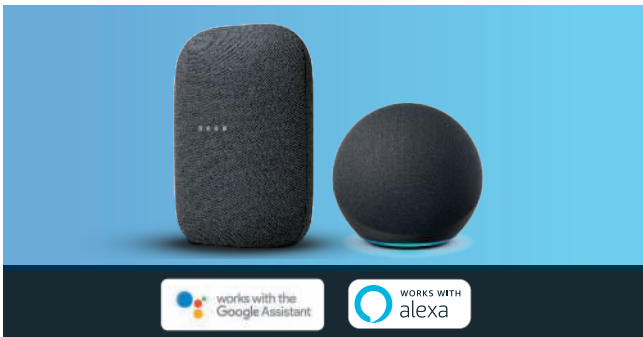

VOICE COMMANDS / SPRACHSTEUERUNG/COMMANDE VOCALE

More convenient! Turn the light on whenever you want with only a voice command.

Noch komfortabler! Mit nur einem Sprachbefehl schaltet sich das Licht nach Ihren Wünschen an und aus.

C'est encore plus confortable ! Allumez votre luminaire comme vous le souhaitez d'une simple commande vocale.

Control options

Steuerungsmöglichkeiten
Possibilités de commande



Set your smart home as you prefer! With the app, voice commands, or remote control.

Steuern Sie Ihr Smart Home wie Sie es möchten! Via App, Sprachsteuerung oder mit der Fernbedienung.

Commandez votre Smart Home comme vous le souhaitez ! Via l'appli, la commande vocale ou la télécommande.



APP CONTROL

Use the free app for smartphone or tablet.
Nutzen Sie die kostenlose App für das Smartphone oder Tablet.

Utilisez l'application gratuite pour smartphone ou tablette.



VOICE COMMANDS

Use intelligent voice assistants such as Google Home and Amazon Alexa.

Nutzen Sie intelligente Sprachassistenten wie Google Home und Amazon Alexa.

Utilisez des assistants vocaux intelligents comme Google Home ou Amazon Alexa.



REMOTE CONTROL

Use the practical remote connect.z operation at any time.

Nutzen Sie auch jederzeit die praktische connect.z Fernbedienung.

Vous pouvez aussi utiliser à tout moment la télécommande connect.z.



CONNECT.Z ACCESSORIES

Use clever accessories such as the movement sensor and much more.

Nutzen Sie cleveres Zubehör wie z.B. den Bewegungssensor uvm.

Utilisez des accessoires malins tels que le capteur de mouvement et bien d'autres encore.



DIMMER FUNCTION

Use the practical dimmer function via app, speech command or remote control.

Nutzen Sie die praktische Dimmfunktion via App, Sprachbefehl oder Fernbedienung.

Utilisez la fonction de gradation via l'appli, la commande vocale ou la télécommande.

One system, many possibilities!

Ein System – viele Möglichkeiten!
Un système, de nombreuses possibilités!

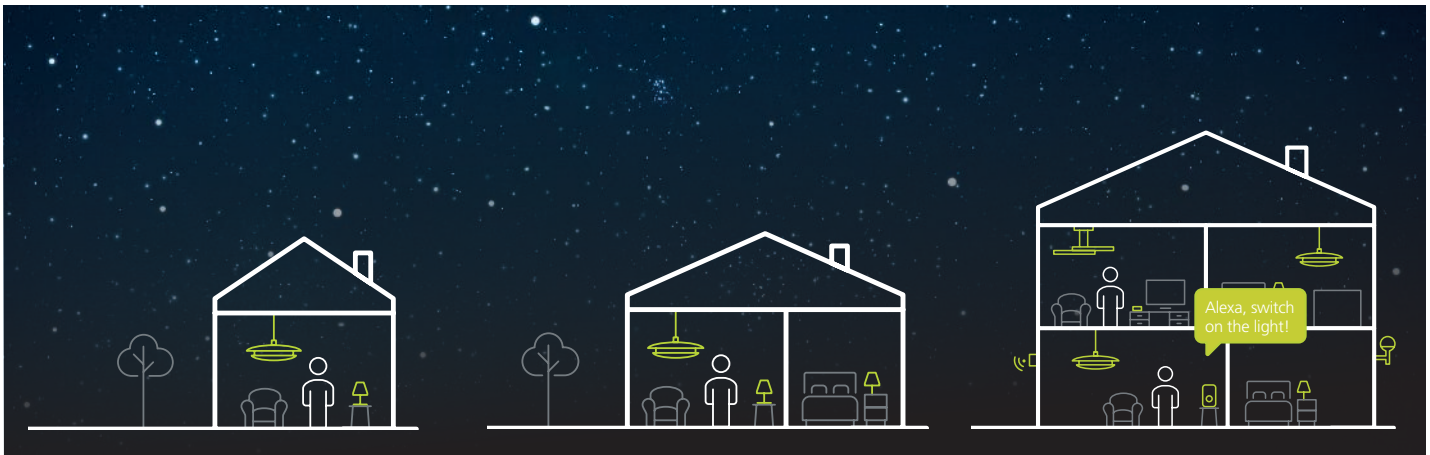

No matter how you start, you can integrate new products into your connect.z system at any time and gradually expand your smart home.
Egal wie Sie starten, Sie können jederzeit neue Produkte in Ihr connect.z System integrieren und Ihr smartes Zuhause nach und nach erweitern.
Quel que soit votre choix, vous pouvez à tout moment intégrer de nouveaux produits à votre système connect.z et améliorer progressivement votre maison intelligente.



BASIC USER

All you need to start is a connect.z product and the remote control. No internet connection is required and you have access to:

Sie benötigen zum Start lediglich ein connect.z Produkt und die Fernbedienung. Es wird kein Internetzugang benötigt und Sie haben Zugriff auf:

Pour démarrer, il vous suffit d'un produit connect.z et de la télécommande. Aucune connexion Internet n'est nécessaire. Vous avez accès aux :

Standard functions:

Standardfunktionen:

Fonctionnalités standard :

- › Select colour/ Farbauswahl/ sélection de couleur
- › Change colour/ Farbwechsel/ changement de couleur
- › Dim/ Dimmen/ gradation
- › Favourites (2x)/ Favoriten (2x)/ favoris (2x)
- › Groups (3x)/ Gruppen (3x)/ groupes (3x)
- › Candle mode/ Kerzenmodus/ mode bougie

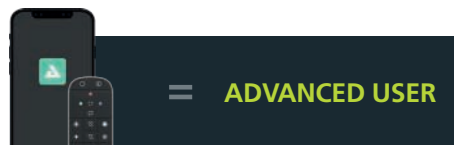

ADVANCED USER

Besides the standard functions, would you also like access to the practical convenience features? Then you need only your smartphone or tablet and the Awox app. This app allows you to control your lights via Bluetooth®.

Sie möchten zu den Standardfunktionen auch noch Zugriff auf die praktischen Komfortfunktionen haben? Dann benötigen Sie nur Ihr Smartphone oder Tablet und die Awox App. Mit der App haben Sie die Möglichkeit, Ihre Leuchten über Bluetooth® zu steuern.

Outre les options standard, vous souhaitez également pouvoir utiliser les fonctionnalités de confort les plus pratiques ? Pour cela, vous avez seulement besoin de votre smartphone ou de votre tablette et de l'appli Awox. L'appli vous permet de commander vos luminaires via Bluetooth®.

Standard functions + convenience features/ Standardfunktionen + Komfortfunktionen / Fonctionnalités standard + confort

- › Light alarm clock/ Lichtwecker/ réveil lumineux
- › Presence simulation/ Anwesenheitssimulation/ simulateur de présence
- › Disco function/ Discofunktion/ fonction disco
- › Timers & timetables /Timer & Zeitpläne/ minuteur et calendrier
- › Accessories can be incorporated/ Einbindung von Zubehör möglich/ connexion d'accessoires possible



POWER USER

Use the system's full potential and control your smart home through the Awox app using WIFI or Bluetooth® as well as integrating a voice assistant into the system. This gives you:

Nutzen Sie das volle Potenzial des Systems und steuern Sie Ihr Smart Home über die Awox App mithilfe von WLAN oder Bluetooth® und integrieren Sie zusätzlich noch einen Sprachassistenten in das System. So mit erhalten Sie:

Exploitez tout le potentiel du système en commandant votre Smart Home grâce à l'appli Awox via le réseau Wi-Fi ou Bluetooth®, et intégrez également un assistant vocal au système. Vous obtenez ainsi :

Standard functions + convenience features + voice commands*

Standardfunktionen + Komfortfunktionen + Sprachsteuerung*

Fonctionnalités standard + confort + commande vocale*

- › Amazon Alexa or Google Home/ Amazon Alexa oder Google Home/ Amazon Alexa ou Google Home

* Use a voice assistant with integrated bridge.

* Nutzen Sie einen Sprachassistenten mit integrierter Bridge.

* Utilisez un assistant vocal avec Bridge intégré.

You already have connect-c luminaires from the previous system! What now?

Sie besitzen bereits connect-c Leuchten des Vorgängersystems! Was nun?
Vous disposez déjà de luminaires connect-c de l'ancien système! Que faire ?

No problem! The previous connect-c products are compatible with the new connect.z system.
Kein Problem! Die bisherigen connect-c Produkte sind mit dem neuen connect.z System kompatibel.
Aucun problème! Les anciens produits connect-c sont compatibles avec le nouveau système connect.z.

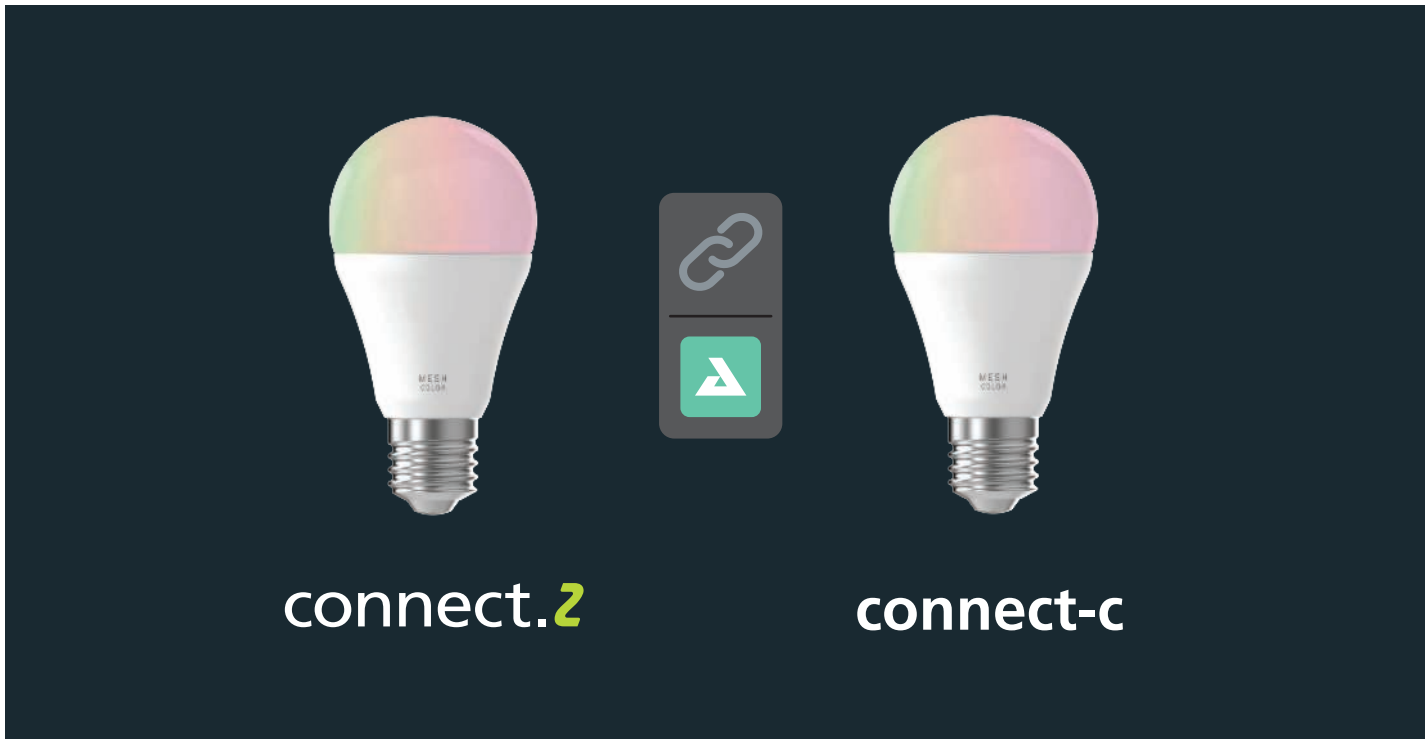

EGLO connect-c - connect.z

The existing EGLO connect-c system is compatible with the new EGLO connect.z system in the Awox Homecontrol App. You do not have to switch from the existing Bluetooth low energy system to the new open protocol ZigBee 3.0. EGLO connect-c luminaires can be integrated in the Awox app.

EGLO connect-c - connect.z

Das bestehende EGLO connect-c System ist mit dem neuen EGLO connect.z System in der Awox Homecontrol App kompatibel. Sie müssen nicht von dem bestehendem Bluetooth low energy System auf das neue offene Protokoll ZigBee 3.0 umsteigen. Leuchten von EGLO connect-c können in der Awox App eingebunden werden.

EGLO connect-c - connect.z

Le système EGLO connect-c existant est compatible avec le nouveau système EGLO connect.z dans l'application Awox Homecontrol. Vous n'avez pas besoin de passer du système Bluetooth low energy existant au nouveau protocole ouvert ZigBee 3.0. Les luminaires EGLO connect-c peuvent être intégrés dans l'application Awox.

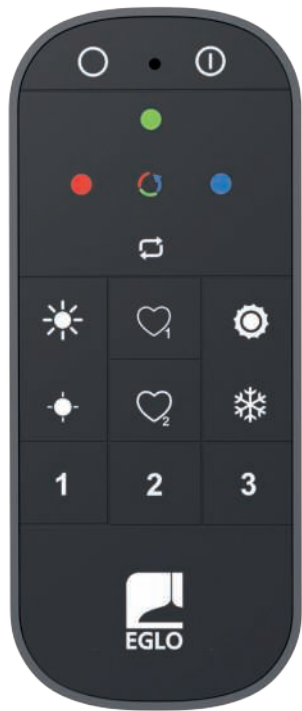

99099

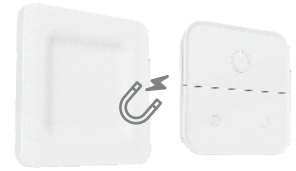

900116

The wall mount can be screwed or glued to smooth surfaces. The switch can be removed from its magnetic holder. With the three buttons, luminaires can be switched off, on and dimmed.

Die Wandhalterung kann geschraubt oder an glatte Oberflächen geklebt werden. Der Schalter kann aus seiner magnetischen Halterung herausgenommen werden. Mit den drei Tasten können Leuchten aus- und eingeschalten und gedimmt werden.

Le support mural peut être vissé ou collé sur une surface lisses. L'interrupteur peut être retiré de son support magnétique. Les trois boutons permettent d'éteindre, d'allumer et de faire varier l'intensité des luminaires.

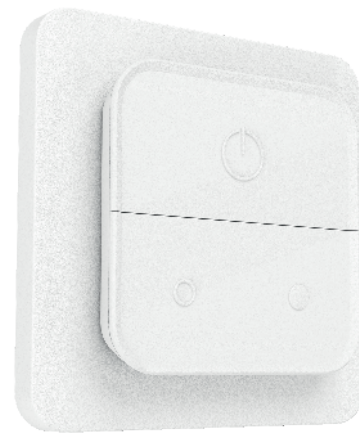

900116

99106



Mounting bracket incl.

Montagehalterung inkl.

Support de montage incl.

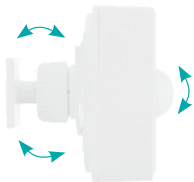

99106



120°, 12 m
20 sec. - 10 min.



IP44

99099 CONNECT Z

remote control; plastic, grey
Fernbedienung; Kunststoff, grau
Télécommande; plastique, gris

L 122, B 54, H 18



AAA,
R03P

1,5V

ACCU



9 002759 990992

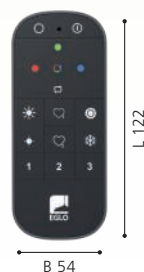

B 54

L 122

99106 CONNECT-Z SENSOR

accessory; plastic, white
Zubehör; Kunststoff, weiss
Accessoires; plastique, blanc

L 75, H 75, A 70



AA,
LR6 HP

2900mA,
1,5V

IP44



9 002759 991067



A 70

L 75

H 75

900116 CONNECT-Z SWITCH

remote control; plastic, white
Fernbedienung; Kunststoff, weiss
Télécommande; plastique, blanc

L 80, B 80, H 7



CR2032



9 008606 285761

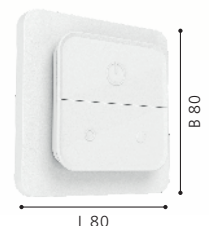

L 80

B 80



900878

LED



900879

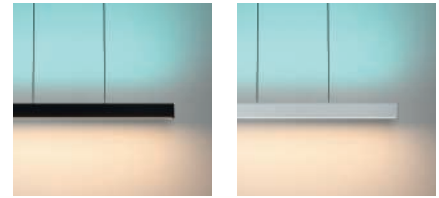

ANDREAS-Z

These luminaires allow the full range of functions through 2 control units. RGB and TW can be adjusted up and down. Both directions can be dimmed independently and the color or whites can be turned on and off together or separately.

Diese Leuchten ermöglichen den vollen Funktionsumfang durch 2 Steuerungseinheiten. RGB und TW können nach oben und unten eingestellt werden. Beide Richtungen können unabhängig voneinander gedimmt werden und die Farbe oder Weißtöne können gemeinsam oder getrennt ein- und ausgeschaltet werden.

Ces luminaires permettent de bénéficier de toutes les fonctionnalités grâce à 2 unités de commande. RGB et TW peuvent être réglés vers le haut et vers le bas. Les deux directions peuvent être atténuées indépendamment l'une de l'autre et les couleurs ou les blancs peuvent être allumés et éteints ensemble ou séparément.



900878 ANDREAS-Z

pendant light; steel, black / plastic, white
Hängeleuchte; Stahl, schwarz / Kunststoff, weiss
luminaire en suspension; acier, noir / plastique, blanc

L 1170, B 70, H 1100

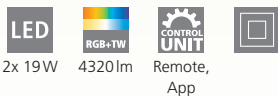

2x 19W 4320lm Remote, App



9 008606 274475

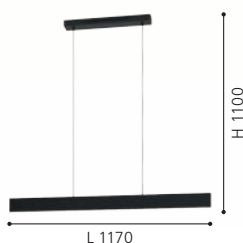

900879 ANDREAS-Z

pendant light; steel, grey / plastic, white
Hängeleuchte; Stahl, grau / Kunststoff, weiss
luminaire en suspension; acier, gris / plastique, blanc

L 1170, B 70, H 1100



2x 19W 4320lm Remote, App



9 008606 274482

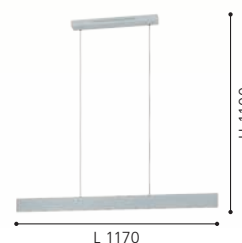



900387



900388



900387 ANCHORENA-Z

ceiling light; wood, steel, brown, black / plastic, white
Deckenleuchte; Holz, Stahl, braun, schwarz / Kunststoff, weiss
plafonnier; bois, acier, marron, noir / plastique, blanc

L 1230, B 80, H 110



35W



3980 lm



Remote,

App



9 008606 243662



900388 ANCHORENA-Z

pendant light; wood, steel, brown, black / plastic, white
Hängeleuchte; Holz, Stahl, braun, schwarz / Kunststoff, weiss
luminaire en suspension; bois, acier, marron, noir / plastique, blanc

L 1230, B 55, H 1100



35W



3980 lm



Remote,

App



9 008606 243679

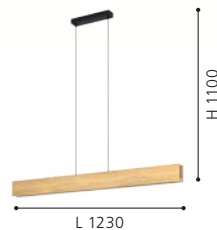

900391 ANCHORENA-Z

table light; wood, steel, brown, black / plastic, white
Tischleuchte; Holz, Stahl, braun, schwarz / Kunststoff, weiss
luminaire de table; bois, acier, marron, noir / plastique, blanc

L 75, B 55, H 465, Base: B 160, T 120



16W



1800 lm



Remote,

App



9 008606 243693





900391



900392 ANCHORENA-Z

floor light; wood, steel, brown, black / plastic, white
 Stehleuchte; Holz, Stahl, braun, schwarz / Kunststoff, weiss
 lampadaire; bois, acier, marron, noir / plastique, blanc

L 105, B 55, H 1500, Base: B 240, T 210



35W



3980lm



Remote,
App



L 105

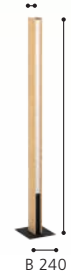

9 008606 243709



900392





900702



900883



900882



900702 KOKOMO-Z

pendant light; steel, wood, black, brown / aluminium, plastic, black, white

Hängeleuchte; Stahl, Holz, schwarz, braun / Alu, Kunststoff, schwarz, weiss

luminaire en suspension; acier, bois, noir, marron / aluminium, plastique, noir, blanc
L 990, B 50, H 1100



34W



4100lm



Remote, App



9 008606 262090

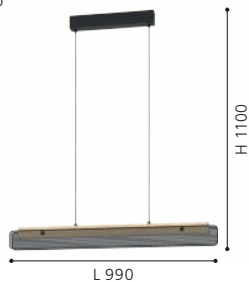

900883 HORNWOOD-Z

pendant light; steel, wood, black, brown

Hängeleuchte; Stahl, Holz, schwarz, braun

luminaire en suspension; acier, bois, noir, marron

L 780, B 140, H 1100



4x 3,7W



2000lm



Remote, App



9 008606 274291



900882 HORNWOOD-Z

ceiling light; steel, wood, black, brown

Deckenleuchte; Stahl, Holz, schwarz, braun

plafonnier; acier, bois, noir, marron

L 780, B 140, H 160



4x 3,7W



2000lm



Remote, App



9 008606 274284



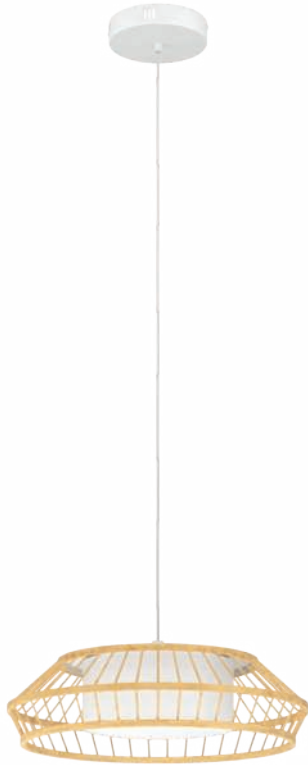

900842

LED



900841

LED

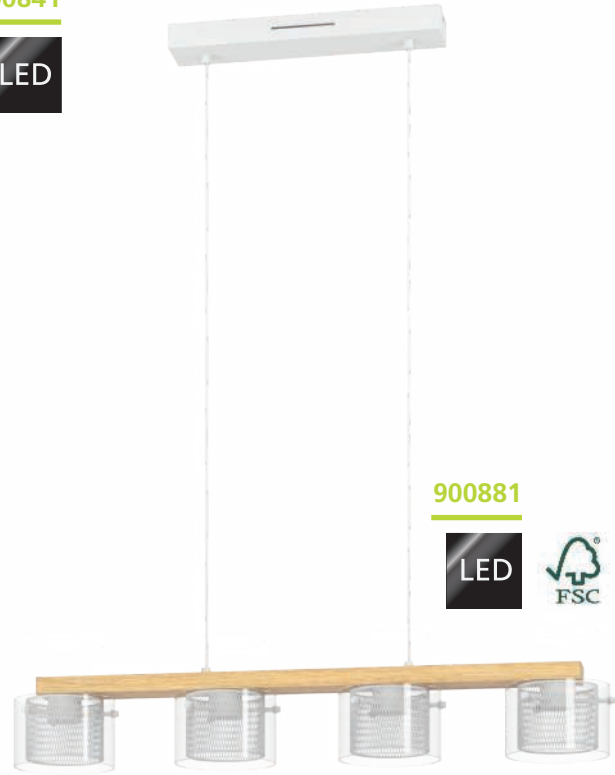

900881

LED



900842 YUKU-Z

pendant light; steel, white / wood, fabric, brown, white
 Hängeleuchte; Stahl, weiss / Holz, Textil, braun, weiss
 luminaire en suspension; acier, blanc / bois, tissu, marron, blanc

H 1100, Ø 460

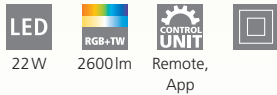

900841 YUKU-Z

ceiling light; steel, white / wood, fabric, brown, white
 Deckenleuchte; Stahl, weiss / Holz, Textil, braun, weiss
 plafonnier; acier, blanc / bois, tissu, marron, blanc

H 160, Ø 460

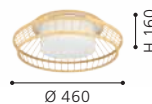

900881 PORTICO-Z

pendant light; steel, wood, white, brown / steel, glass, white, clear
 Hängeleuchte; Stahl, Holz, weiss, braun / Stahl, Glas, weiss, klar
 luminaire en suspension; acier, bois, blanc, marron / acier, verre, blanc, transparent

L 880, B 150, H 1100

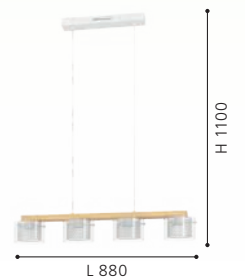



900853

LED



900855

LED

900853 BARBANO-Z

ceiling light; steel, black / fabric, plastic, black, white
 Deckenleuchte; Stahl, schwarz / Textil, Kunststoff, schwarz, weiss
 plafonnier; acier, noir / tissu, plastique, noir, blanc

L 605, B 565, H 90



3x 7,5W



2765lm



Remote,
App



900855 BARBANO-Z

ceiling light; steel, black / fabric, plastic, grey, white
 Deckenleuchte; Stahl, schwarz / Textil, Kunststoff, grau, weiss
 plafonnier; acier, noir / tissu, plastique, gris, blanc

L 605, B 565, H 90



3x 7,5W



2765lm



Remote,
App



9 008606 274185



9 008606 274208





900854 BARBANO-Z

pendant light; steel, black / fabric, plastic, black, white
 Hängeleuchte; Stahl, schwarz / Textil, Kunststoff, schwarz, weiss
 luminaire en suspension; acier, noir / tissu, plastique, noir, blanc

L 820, B 300, H 1100



900856 BARBANO-Z

pendant light; steel, black / fabric, plastic, grey, white
 Hängeleuchte; Stahl, schwarz / Textil, Kunststoff, grau, weiss
 luminaire en suspension; acier, noir / tissu, plastique, gris, blanc

L 820, B 300, H 1100





900439



900441



900442



900439 ROMAO-Z

ceiling light; steel, white / fabric, plastic, white
Deckenleuchte; Stahl, weiss / Textil, Kunststoff, weiss
plafonnier; acier, blanc / tissu, plastique, blanc

H 150, Ø 570

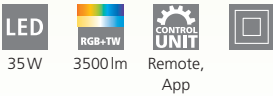

900441 ROMAO-Z

ceiling light; steel, white / fabric, plastic, taupe, white
Deckenleuchte; Stahl, weiss / Textil, Kunststoff, taupe, weiss
plafonnier; acier, blanc / tissu, plastique, taupe, blanc

H 150, Ø 570

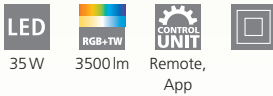

900442 ROMAO-Z

ceiling light; steel, white / fabric linen, plastic, grey, white
Deckenleuchte; Stahl, weiss / Textil Leinen, Kunststoff, grau, weiss
plafonnier; acier, blanc / tissu de lin, plastique, gris, blanc

H 150, Ø 570



9 008606 243914



9 008606 243921

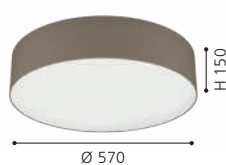

9 008606 243938





900406

LED



DIMMABLE
VIA REMOTE
AND APP



900407

LED

900406 TOLLOS-Z

ceiling light; aluminium, steel, black, white / plastic, white
Deckenleuchte; Alu, Stahl, schwarz, weiss / Kunststoff, weiss
plafonnier; aluminium, acier, noir, blanc / plastique, blanc

H 130, Ø 400

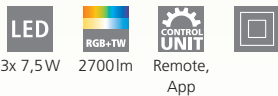

3x 7,5W 2700lm Remote, App



9 008606 243792



900407 TOLLOS-Z

ceiling light; aluminium, steel, black, white / plastic, white
Deckenleuchte; Alu, Stahl, schwarz, weiss / Kunststoff, weiss
plafonnier; aluminium, acier, noir, blanc / plastique, blanc

H 130, Ø 550

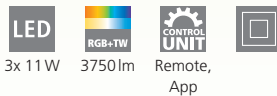

3x 11W 3750lm Remote, App



9 008606 243808





900723

LED





900722

LED



900724

LED

900723 GINESTRONE-Z

pendant light; steel, black / plastic, white
Hängeleuchte; Stahl, schwarz / Kunststoff, weiss
luminaire en suspension; acier, noir / plastique, blanc

H 1100, Ø 450

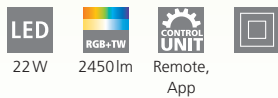

22W 2450lm Remote, App



9 008606 270507



900722 GINESTRONE-Z

ceiling light; steel, black / plastic, white
Deckenleuchte; Stahl, schwarz / Kunststoff, weiss
plafonnier; acier, noir / plastique, blanc

H 220, Ø 450



22W 2450lm Remote, App



9 008606 270491



900724 GINESTRONE-Z

pendant light; steel, black / plastic, white
Hängeleuchte; Stahl, schwarz / Kunststoff, weiss
luminaire en suspension; acier, noir / plastique, blanc

L 900, B 200, H 1100



3x 3,7W 1350lm Remote, App



9 008606 274857

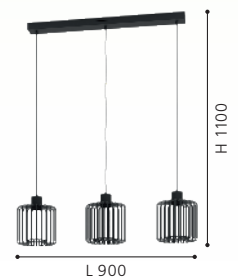



99679 SALVILANAS-Z

ceiling light; aluminium, steel, black / plastic, white
 Deckenleuchte; Alu, Stahl, schwarz / Kunststoff, weiss
 plafonnier; aluminium, acier, noir / plastique, blanc

L 770, B 200, H 75



21W 2700lm Remote, App



9 002759 996796



99678 SALVILANAS-Z

pendant light; aluminium, steel, black / plastic, white
 Hängeleuchte; Alu, Stahl, schwarz / Kunststoff, weiss
 luminaire en suspension; aluminium, acier, noir / plastique, blanc

L 770, B 200, H 1100



21W 2700lm Remote, App



9 002759 996789

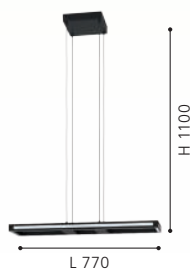

99681 SALVILANAS-Z

pendant light; aluminium, steel, black / plastic, white
 Hängeleuchte; Alu, Stahl, schwarz / Kunststoff, weiss
 luminaire en suspension; aluminium, acier, noir / plastique, blanc

L 1160, B 200, H 1100



33W 4300lm Remote, App



9 002759 996819

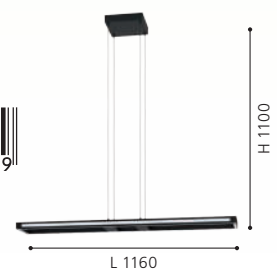



99682



99683



99682 SALVILANAS-Z

table light; aluminium, steel, black / plastic, white
Tischleuchte; Alu, Stahl, schwarz / Kunststoff, weiss
luminaire de table; aluminium, acier, noir / plastique, blanc

L 160, B 35, H 425, Base: B 240, T 160



9 002759 996826



99683 SALVILANAS-Z

floor light; aluminium, steel, black / plastic, white
Stehleuchte; Alu, Stahl, schwarz / Kunststoff, weiss
lampadaire; aluminium, acier, noir / plastique, blanc

L 200, B 35, H 1305, Base: B 280, T 180



9 002759 996833

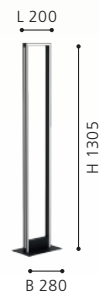

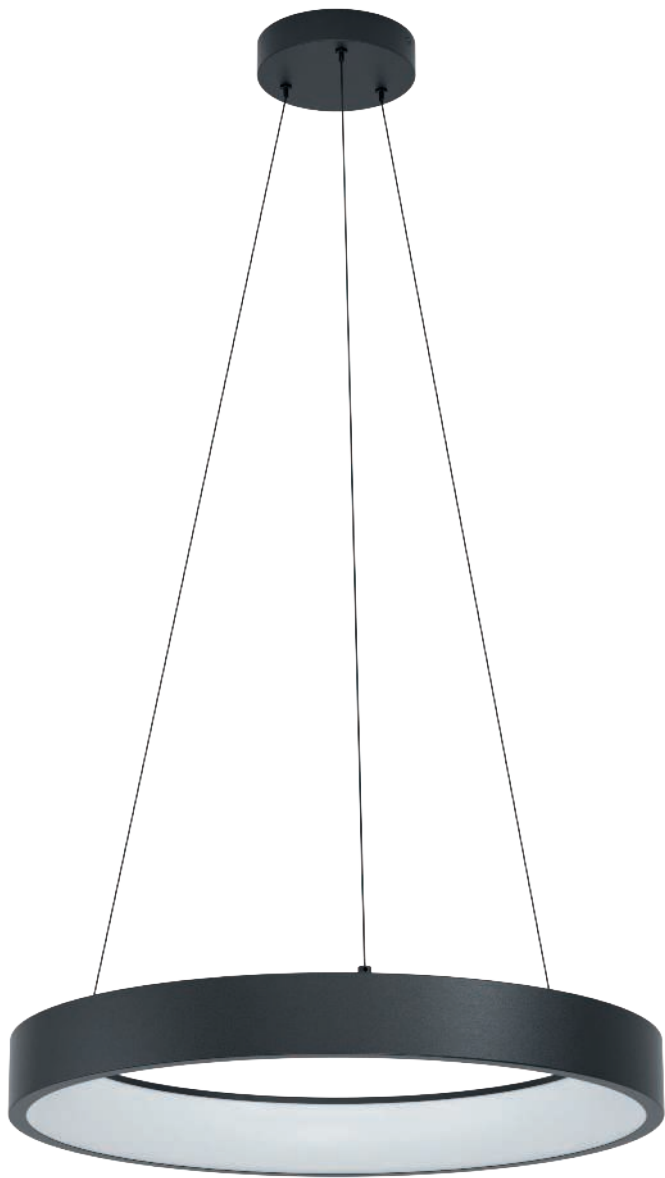

900068



900067



900069



900068 MARGHERA-Z

pendant light; steel, black / plastic, white
 Hängeleuchte; Stahl, schwarz / Kunststoff, weiss
 luminaire en suspension; acier, noir / plastique, blanc

H 1100, Ø 600



4x 6,5W 3120lm Remote, App

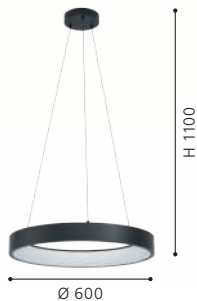

900067 MARGHERA-Z

ceiling light; steel, black / plastic, white
 Deckenleuchte; Stahl, schwarz / Kunststoff, weiss
 plafonnier; acier, noir / plastique, blanc

H 110, Ø 600



4x 6,5W 3120lm Remote, App



900069 MARGHERA-Z

wall light; steel, black / plastic, white
 Wandleuchte; Stahl, schwarz / Kunststoff, weiss
 Applique; acier, noir / plastique, blanc

L 270, H 305, A 200



4x 4W 1800lm Remote, App





900071



900072



900071 MARGHERA-Z

table light; steel, black / plastic, white
Tischleuchte; Stahl, schwarz / Kunststoff, weiss
luminaire de table; acier, noir / plastique, blanc

L 270, H 265, Base: Ø 145

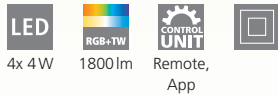

900072 MARGHERA-Z

floor light; steel, black / plastic, white
Stehleuchte; Stahl, schwarz / Kunststoff, weiss
lampadaire; acier, noir / plastique, blanc

L 270, B 305, H 1690, Base: Ø 305

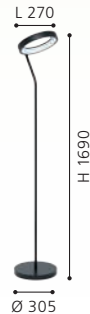



99603



99601



99602



99603 SIMOLARIS-Z

pendant light; aluminium, steel, black / plastic, white
Hängeleuchte; Alu, Stahl, schwarz / Kunststoff, weiss
luminaire en suspension; aluminium, acier, noir / plastique, blanc

L 1220, B 55, H 1100

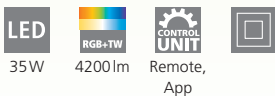

99601 SIMOLARIS-Z

ceiling light; aluminium, steel, black / plastic, white
Deckenleuchte; Alu, Stahl, schwarz / Kunststoff, weiss
plafonnier; aluminium, acier, noir / plastique, blanc

L 470, B 55, H 110



99602 SIMOLARIS-Z

ceiling light; aluminium, steel, black / plastic, white
Deckenleuchte; Alu, Stahl, schwarz / Kunststoff, weiss
plafonnier; aluminium, acier, noir / plastique, blanc

L 1220, B 55, H 110





99604

LED



99605

LED

99604 SIMOLARIS-Z

table light; aluminium, steel, black / plastic, white
Tischleuchte; Alu, Stahl, schwarz / Kunststoff, weiss
luminaire de table; aluminium, acier, noir / plastique, blanc

L 55, B 55, H 515, Base: B 160, T 120



99605 SIMOLARIS-Z

floor light; aluminium, steel, black / plastic, white
Stehleuchte; Alu, Stahl, schwarz / Kunststoff, weiss
lampadaire; aluminium, acier, noir / plastique, blanc

L 55, B 55, H 1615, Base: B 240, T 210





900079



900081



900082



900079 FRAIOLI-Z

ceiling light; aluminium, black / plastic, white
Deckenleuchte; Alu, schwarz / Kunststoff, weiss
plafonnier; aluminium, noir / plastique, blanc

L 1055, B 120, H 65

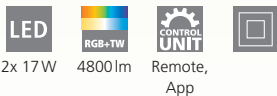

2x 17W 4800lm Remote, App



900081 FRAIOLI-Z

pendant light; aluminium, black / plastic, white
Hängeleuchte; Alu, schwarz / Kunststoff, weiss
luminaire en suspension; aluminium, noir / plastique, blanc

L 1055, B 100, H 1200



2x 17W 4800lm Remote, App



900082 FRAIOLI-Z

floor light; aluminium, black / plastic, white
Stehleuchte; Alu, schwarz / Kunststoff, weiss
lampadaire; aluminium, noir / plastique, blanc

H 1755, Base: B 280, T 280



2x 17W 4800lm Remote, App





900076



900077



900078



900076 FRAIOLI-Z

ceiling light; aluminium, satin nickel / plastic, white
Deckenleuchte; Alu, nickel-matt / Kunststoff, weiss
plafonnier; aluminium, nickel mat / plastique, blanc

L 1055, B 120, H 65



2x 17W 4800lm Remote, App



9 008606 223534

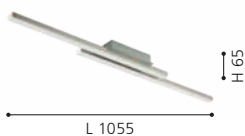

900077 FRAIOLI-Z

pendant light; aluminium, satin nickel / plastic, white
Hängeleuchte; Alu, nickel-matt / Kunststoff, weiss
luminaire en suspension; aluminium, nickel mat / plastique, blanc

L 1055, B 100, H 1200



2x 17W 4800lm Remote, App



9 008606 223541



900078 FRAIOLI-Z

floor light; aluminium, satin nickel / plastic, white
Stehleuchte; Alu, nickel-matt / Kunststoff, weiss
lampadaire; aluminium, nickel mat / plastique, blanc

H 1755, Base: B 280, T 280



2x 17W 4800lm Remote, App



9 008606 223558

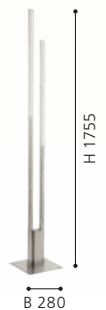



900479

LED



900478

LED

900479 LOBINERO-Z

pendant light; aluminium, steel, black / plastic, white
 Hängeleuchte; Alu, Stahl, schwarz / Kunststoff, weiss
 luminaire en suspension; aluminium, acier, noir / plastique, blanc

H 1100, Ø 580



43,2W 6000 lm Remote, App



9 008606 244157



900478 LOBINERO-Z

pendant light; aluminium, steel, white / plastic, white
 Hängeleuchte; Alu, Stahl, weiss / Kunststoff, weiss
 luminaire en suspension; aluminium, acier, blanc / plastique, blanc

H 1100, Ø 580



43,2W 6000 lm Remote, App



9 008606 244140



900398 ZILLERIO-Z

pendant light; steel, aluminium, black / plastic, white
 Hängeleuchte; Stahl, Alu, schwarz / Kunststoff, weiss
 luminaire en suspension; acier, aluminium, noir / plastique, blanc

L 1160, B 300, H 1100



2x 8W 2160 lm 3x 2,7W 1080 lm Remote, App



9 008606 240593

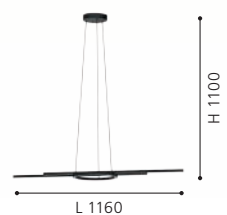



900398

LED

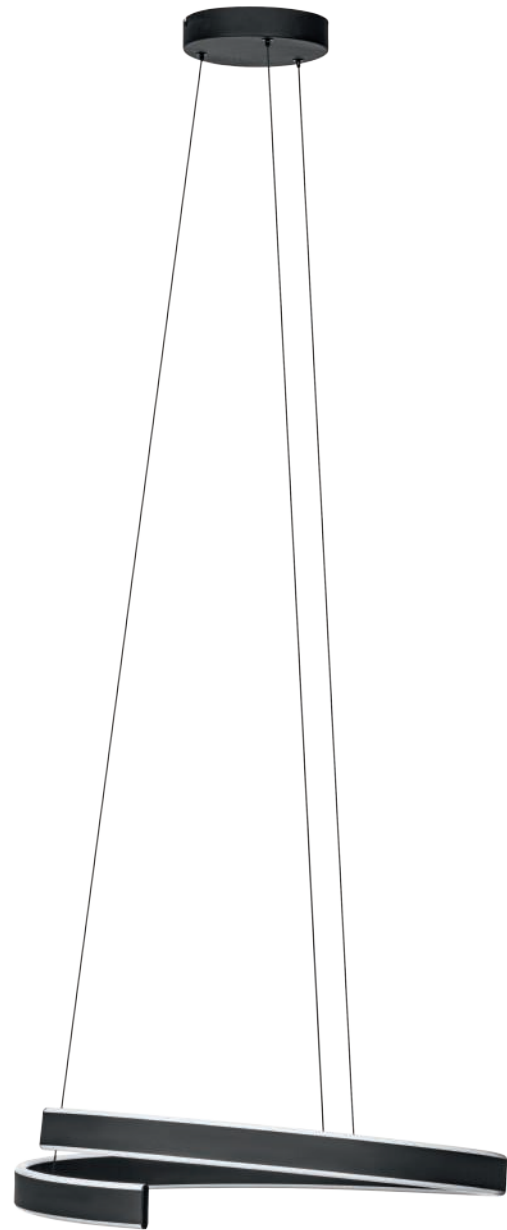

900404

LED

900404 ANDABAIA-Z

pendant light; aluminium, steel, black / plastic, white
 Hängeleuchte; Alu, Stahl, schwarz / Kunststoff, weiss
 luminaire en suspension; aluminium, acier, noir / plastique, blanc

H 1540, Ø 600

LED

42,5W

tunable
WHITE

5300lm

CONTROL
UNIT

Remote,
App

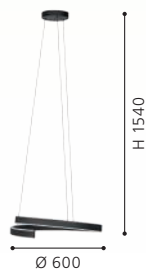



900019



IP44



900021



IP44

900019 TABIANO-Z

mirror light; steel, chrome / plastic, white
 Spiegelleuchte; Stahl, chrom / Kunststoff, weiss
 applique pour miroir; acier, chrome / plastique, blanc

L 605, H 70, A 135



15,6W



1950lm



Remote,
App



IP44



900021 TABIANO-Z

mirror light; steel, chrome / plastic, white
 Spiegelleuchte; Stahl, chrom / Kunststoff, weiss
 applique pour miroir; acier, chrome / plastique, blanc

L 905, H 70, A 135



21,5W



2750lm



Remote,
App



IP44



9 008606 221646



9 008606 221653





99676

LED



99677

LED



99676 LOMALTAS-Z

ceiling light; steel, wood, black, brown / plastic, white
Deckenleuchte; Stahl, Holz, schwarz, braun / Kunststoff, weiss
plafonnier; acier, bois, noir, marron / plastique, blanc

L 580, B 350



4x 8W 4400lm Remote, App

99677 LOMALTAS-Z

ceiling light; steel, wood, black, brown / plastic, white
Deckenleuchte; Stahl, Holz, schwarz, braun / Kunststoff, weiss
plafonnier; acier, bois, noir, marron / plastique, blanc

L 770, B 495, H 85



4x 8W 4400lm Remote, App



9 002759 996765



9 002759 996772

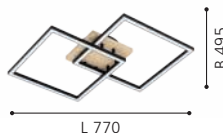

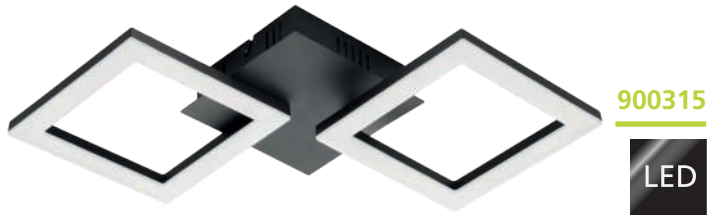

900315

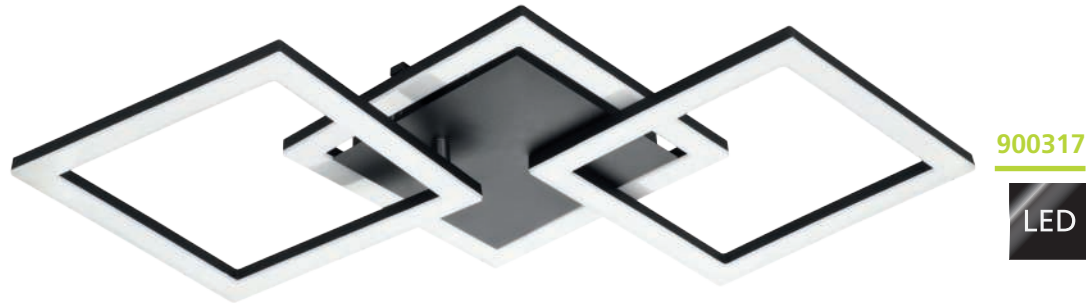

900317

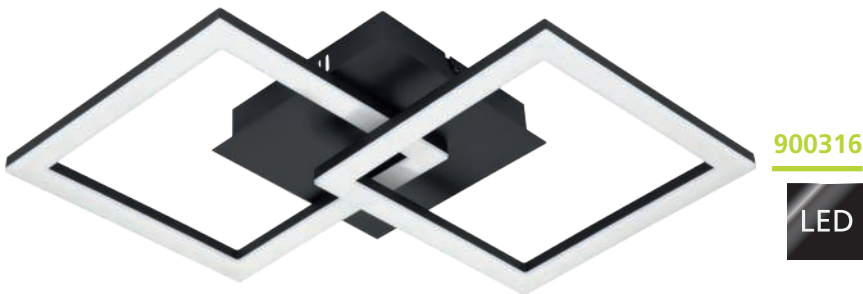

900316



900315 PARANDAY-Z

ceiling light; steel, black / plastic, white
Deckenleuchte; Stahl, schwarz / Kunststoff, weiss
plafonnier; acier, noir / plastique, blanc

L 470, B 225, H 60



15,5W 1800lm Remote, App

900316 PARANDAY-Z

ceiling light; steel, black / plastic, white
Deckenleuchte; Stahl, schwarz / Kunststoff, weiss
plafonnier; acier, noir / plastique, blanc

L 525, B 310, H 60



21,5W 2500lm Remote, App

900317 PARANDAY-Z

ceiling light; steel, black / plastic, white
Deckenleuchte; Stahl, schwarz / Kunststoff, weiss
plafonnier; acier, noir / plastique, blanc

L 650, B 310, H 60



32,4W 4000lm Remote, App



9 008606 231195

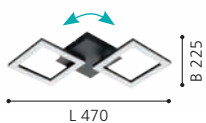

9 008606 231201

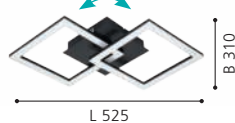

9 008606 231218

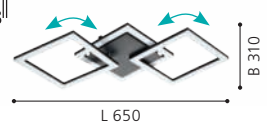



900318 PARANDAY-Z

ceiling light; steel, black / plastic, white
Deckenleuchte; Stahl, schwarz / Kunststoff, weiss
plafonnier; acier, noir / plastique, blanc

L 470, B 430, H 65



42 W



5000 lm



Remote,
App



9 008606 231225



900318





900322



900323



900324



900322 PARRAPOS-Z

ceiling light; steel, black / plastic, white
Deckenleuchte; Stahl, schwarz / Kunststoff, weiss
plafonnier; acier, noir / plastique, blanc

L 445, B 300, H 70



900323 PARRAPOS-Z

ceiling light; steel, black / plastic, white
Deckenleuchte; Stahl, schwarz / Kunststoff, weiss
plafonnier; acier, noir / plastique, blanc

L 340, B 300, H 45



900324 PARRAPOS-Z

wall light; steel, black / plastic, white
Wandleuchte; Stahl, schwarz / Kunststoff, weiss
Applique; acier, noir / plastique, blanc

L 200, H 240, A 50



9 008606 231256



9 008606 231263

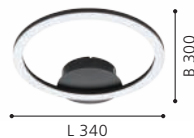

9 008606 231270





900319



900321



900319 PARRAPOS-Z

ceiling light; steel, black / plastic, white
 Deckenleuchte; Stahl, schwarz / Kunststoff, weiss
 plafonnier; acier, noir / plastique, blanc

L 615, B 450, H 80



900321 PARRAPOS-Z

ceiling light; steel, black / plastic, white
 Deckenleuchte; Stahl, schwarz / Kunststoff, weiss
 plafonnier; acier, noir / plastique, blanc

L 545, B 445, H 90

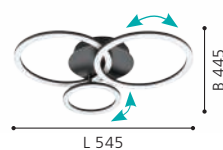
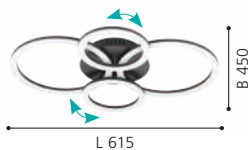

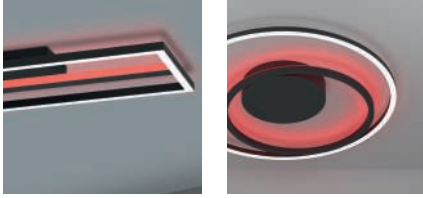

CALAGRANO-Z

These lights have individually controllable light settings on the inside and outside of the frame.

Diese Leuchten verfügen über individuell steuerbare Lichteinstellungen der Rahmen innen und außen.

Ces lumières ont des paramètres d'éclairage contrôlables individuellement du cadre.



900729

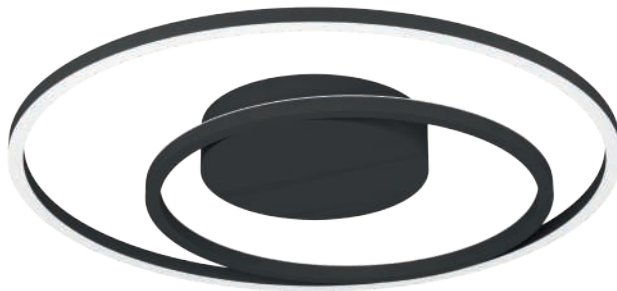

900728



900567



900728 CALAGRANO-Z

ceiling light; aluminium, steel, black / plastic, white
Deckenleuchte; Alu, Stahl, schwarz / Kunststoff, weiss
plafonnier; aluminium, acier, noir / plastique, blanc

H 35, Ø 450



21,5W



2700lm



Remote,
App



900729 CALAGRANO-Z

ceiling light; aluminium, steel, black / plastic, white
Deckenleuchte; Alu, Stahl, schwarz / Kunststoff, weiss
plafonnier; aluminium, acier, noir / plastique, blanc

L 450, B 450, H 50



21W



2900lm



Remote,
App



900567 CALAGRANO-Z

ceiling light; aluminium, steel, black / plastic, white
Deckenleuchte; Alu, Stahl, schwarz / Kunststoff, weiss
plafonnier; aluminium, acier, noir / plastique, blanc

L 640, B 220, H 50



21W



2600lm



Remote,
App



9 008606 262229



9 008606 262236

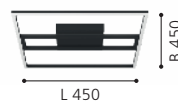

9 008606 244690

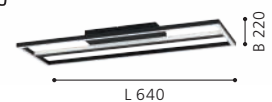



900566 CALAGRANO-Z

ceiling light; aluminium, steel, black / plastic, white
Deckenleuchte; Alu, Stahl, schwarz / Kunststoff, weiss
plafonnier; aluminium, acier, noir / plastique, blanc

L 640, B 240, H 45



21 W



2600 lm



Remote,
App



9 008606 244683

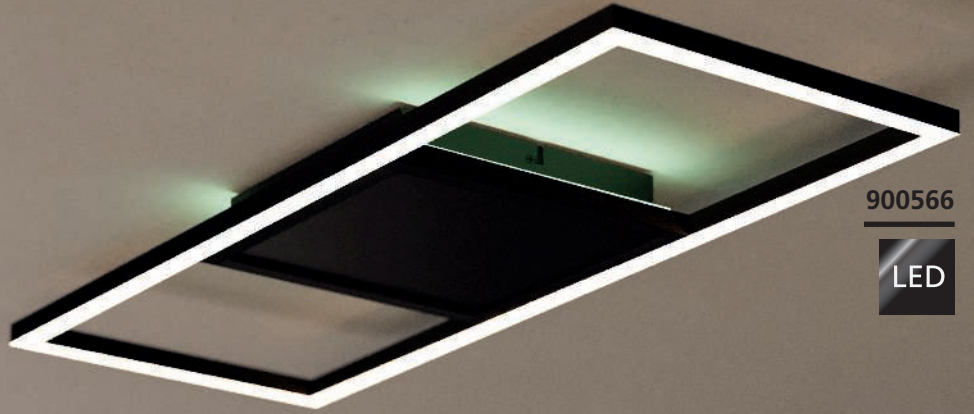
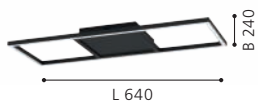

900566

LED



900408



900409



900408 MONTEMORELOS-Z

ceiling light; aluminium, white / plastic with crystal effect, white
Deckenleuchte; Alu, weiss / Kunststoff m. Kristalleffekt, weiss
plafonnier; aluminium, blanc / plastique avec effet cristal, blanc

H 50, Ø 420

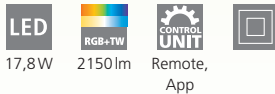

17,8W 2150lm Remote, App



9 008606 243815



900409 MONTEMORELOS-Z

ceiling light; aluminium, white / plastic with crystal effect, white
Deckenleuchte; Alu, weiss / Kunststoff m. Kristalleffekt, weiss
plafonnier; aluminium, blanc / plastique avec effet cristal, blanc

H 70, Ø 570



34,5W 4100lm Remote, App



9 008606 243822





900411



900412

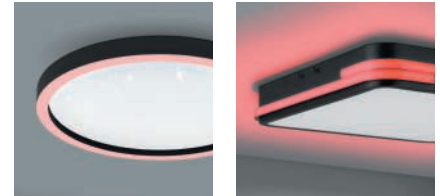

MONTEMORELOS-Z, GENOVESE-Z

The frame of these luminaires can switch between the RGB colors, the inner part can reproduce different white tones between 2700K and 6500K. By controlling via app or remote control, individual lighting effects can be set.

Der Rahmen dieser Leuchten kann zwischen den RGB Farbtönen wechseln, der Innenteil kann verschiedene Weißtöne zwischen 2700K und 6500K wiedergeben. Durch Steuerung per App oder Fernbedienung können so individuelle Lichtspiele eingestellt werden.

Le cadre de cette luminaires peut basculer entre les couleurs RVB, la partie intérieure peut reproduire différents tons blancs entre 2700K et 6500K. En contrôlant via l'application ou la télécommande, des effets d'éclairage individuels peuvent être définis.



900477



900411 MONTEMORELOS-Z

ceiling light; aluminium, black / plastic with crystal effect, white
Deckenleuchte; Alu, schwarz / Kunststoff m. Kristalleffekt, weiss
plafonnier; aluminium, noir / plastique avec effet cristal, blanc

H 50, Ø 420

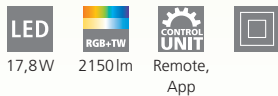

17,8W 2150lm Remote, App



9 008606 243839



900412 MONTEMORELOS-Z

ceiling light; aluminium, black / plastic with crystal effect, white
Deckenleuchte; Alu, schwarz / Kunststoff m. Kristalleffekt, weiss
plafonnier; aluminium, noir / plastique avec effet cristal, blanc

H 70, Ø 570



34,5W 4100lm Remote, App



9 008606 243846



900477 GENOVESE-Z

ceiling light; aluminium, steel, black / plastic, white
Deckenleuchte; Alu, Stahl, schwarz / Kunststoff, weiss
plafonnier; aluminium, acier, noir / plastique, blanc

L 470, B 470, H 70



22W 3000lm Remote, App



9 008606 252763





900088

LED



900086

LED



900089

LED



ROVITO-Z

These lights have individually controllable light settings on the inside and outside of the frame.

Diese Leuchten verfügen über individuell steuerbare Lichtstellungen der Rahmen innen und außen.

Ces lumières ont des paramètres d'éclairage contrôlables individuellement du cadre.

900088 ROVITO-Z

ceiling light; plastic, white / plastic, white
Deckenleuchte; Kunststoff, weiss / Kunststoff, weiss
plafonnier; plastique, blanc / plastique, blanc

L 295, B 295, H 25

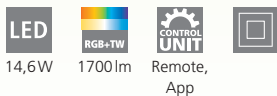

14,6W 1700lm Remote, App

900089 ROVITO-Z

ceiling light; plastic, white / plastic, white
Deckenleuchte; Kunststoff, weiss / Kunststoff, weiss
plafonnier; plastique, blanc / plastique, blanc

L 420, B 420, H 25



16,5W 2200lm Remote, App

900086 ROVITO-Z

ceiling light; plastic, white / plastic, white
Deckenleuchte; Kunststoff, weiss / Kunststoff, weiss
plafonnier; plastique, blanc / plastique, blanc

H 25, Ø 295

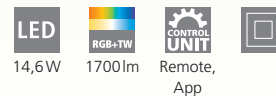

14,6W 1700lm Remote, App



9 008606 225491



L 295



9 008606 225507



L 420



9 008606 225477



Ø 295



900087 ROVITO-Z

ceiling light; plastic, white / plastic, white

Deckenleuchte; Kunststoff, weiss / Kunststoff, weiss

plafonnier; plastique, blanc / plastique, blanc

H 25, Ø 420

LED

16,5W

RGB+TW

2200lm

CONTROL
UNIT

Remote,
App



9 008606 225484





900093



900092



900094



900093 ROVITO-Z

ceiling light; plastic, black / plastic, white
Deckenleuchte; Kunststoff, schwarz / Kunststoff, weiss
plafonnier; plastique, noir / plastique, blanc

L 295, B 295, H 25



14,6W



1700lm



Remote,
App



900094 ROVITO-Z

ceiling light; plastic, black / plastic, white
Deckenleuchte; Kunststoff, schwarz / Kunststoff, weiss
plafonnier; plastique, noir / plastique, blanc

L 420, B 420, H 25



16,5W



2200lm



Remote,
App



900092 ROVITO-Z

ceiling light; plastic, black / plastic, white
Deckenleuchte; Kunststoff, schwarz / Kunststoff, weiss
plafonnier; plastique, noir / plastique, blanc

H 25, Ø 420



16,5W



2200lm



Remote,
App



9 008606 225538

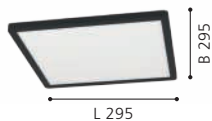

9 008606 225545



9 008606 225521





ROVITO-Z

These lights have individually controllable light settings on the inside and outside of the frame.

Diese Leuchten verfügen über individuell steuerbare Lichteinstellungen der Rahmen innen und außen.

Ces lumières ont des paramètres d'éclairage contrôlables individuellement du cadre.

900091 ROVITO-Z

ceiling light; plastic, black / plastic, white
 Deckenleuchte; Kunststoff, schwarz / Kunststoff, weiss
 plafonnier; plastique, noir / plastique, blanc

H 25, Ø 295



14,6W

1700lm

Remote,
App



9 008606 225514



900091

LED



900481



900484



900483



900481 PADROGIANO-Z

ceiling light; steel, white / plastic, white
Deckenleuchte; Stahl, weiss / Kunststoff, weiss
plafonnier; acier, blanc / plastique, blanc

L 450, B 450, H 50



26,2W



3800lm



Remote,
App



900483 PADROGIANO-Z

ceiling light; steel, white / plastic, white
Deckenleuchte; Stahl, weiss / Kunststoff, weiss
plafonnier; acier, blanc / plastique, blanc

L 450, B 450, H 50



27,9W



3600lm



Remote,
App



900484 PADROGIANO-Z

ceiling light; steel, white / plastic, white
Deckenleuchte; Stahl, weiss / Kunststoff, weiss
plafonnier; acier, blanc / plastique, blanc

L 595, B 595, H 50



35,5W



4800lm



Remote,
App



9 008606 244164

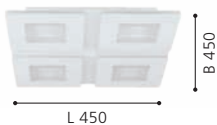

9 008606 244188



9 008606 244195





900486

LED



PADROGIANO-Z

These lights have individually controllable light settings on the inside and outside of the frame.

Diese Leuchten verfügen über individuell steuerbare Lichteinstellungen der Rahmen innen und außen.

Ces lumières ont des paramètres d'éclairage contrôlables individuellement du cadre.



900487

LED



900486 PADROGIANO-Z

ceiling light; steel, white / plastic, white
Deckenleuchte; Stahl, weiss / Kunststoff, weiss
plafonnier; acier, blanc / plastique, blanc

H 50, Ø 450



900487 PADROGIANO-Z

ceiling light; steel, white / plastic, white
Deckenleuchte; Stahl, weiss / Kunststoff, weiss
plafonnier; acier, blanc / plastique, blanc

H 50, Ø 595



9 008606 244218



9 008606 244225





900482

LED



PADROGIANO-Z

The frame of these luminaires can switch between the RGB colors, the inner part can reproduce different white tones between 2700K and 6500K. By controlling via app or remote control, individual lighting effects can be set.

Der Rahmen dieser Leuchten kann zwischen den RGB Farbtönen wechseln, der Innenteil kann verschiedene Weißtöne zwischen 2700K und 6500K wiedergeben. Durch Steuerung per App oder Fernbedienung können so individuelle Lichtspiele eingestellt werden.

Le cadre de cette luminaires peut basculer entre les couleurs RVB, la partie intérieure peut reproduire différents tons blancs entre 2700K et 6500K. En contrôlant via l'application ou la télécommande, des effets d'éclairage individuels peuvent être définis.



900482 PADROGIANO-Z

ceiling light; steel, white / plastic, white
Deckenleuchte; Stahl, weiss / Kunststoff, weiss
plafonnier; acier, blanc / plastique, blanc

L 1200, B 300, H 50



42,5 W 6000 lm Remote, App



9 008606 244171

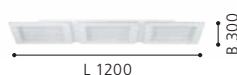

900485 PADROGIANO-Z

ceiling light; steel, white / plastic, white
Deckenleuchte; Stahl, weiss / Kunststoff, weiss
plafonnier; acier, blanc / plastique, blanc

L 1200, B 300, H 50



43,2 W 6000 lm Remote, App



9 008606 244201

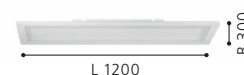



900485

LED

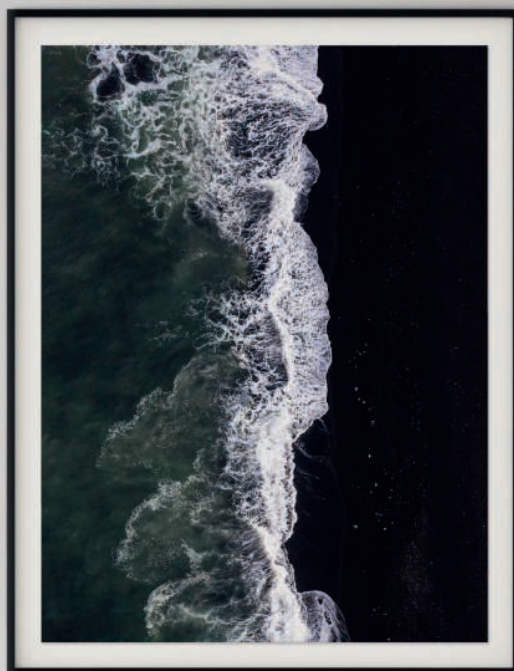



900025

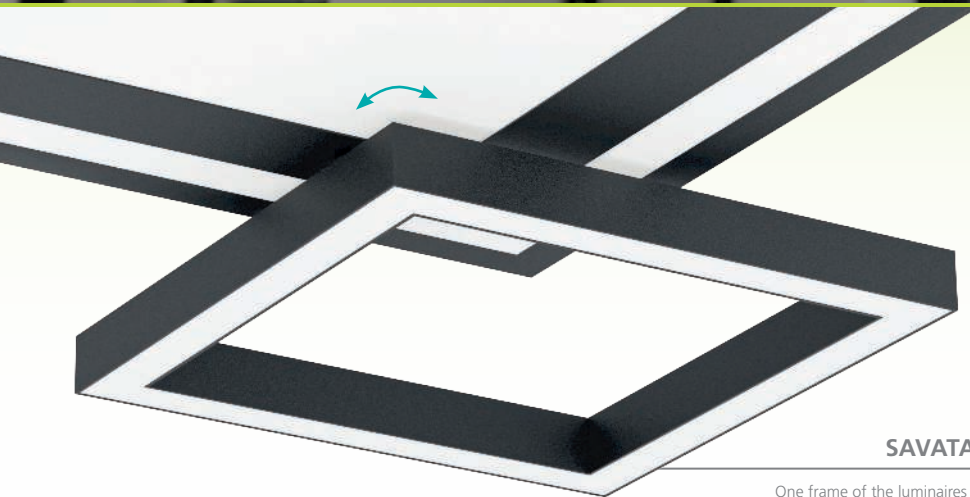

SAVATARILA-Z

One frame of the luminaires is rotatable.
 Ein Rahmen der Leuchten ist drehbar.
 Un cadre de les luminaires est rotatif.

900025 SAVATARILA-Z

ceiling light; steel, black / plastic, white
 Deckenleuchte; Stahl, schwarz / Kunststoff, weiss
 plafonnier; acier, noir / plastique, blanc

L 450, B 450, H 70



4x 2,7W



1320lm



4x 2,7W



1280lm



Remote,
App

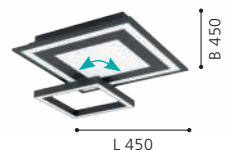



900022



900024

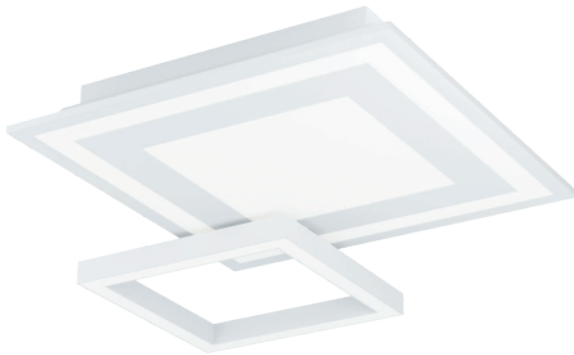

900023



900023 SAVATARILA-Z

ceiling light; steel, white / plastic, white
Deckenleuchte; Stahl, weiss / Kunststoff, weiss
plafonnier; acier, blanc / plastique, blanc

L 450, B 450, H 70



9 008606 221677

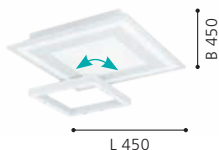

900022 SALITERAS-Z

ceiling light; steel, white / plastic, white
Deckenleuchte; Stahl, weiss / Kunststoff, weiss
plafonnier; acier, blanc / plastique, blanc

L 1160, B 160, H 50



9 008606 221660



900024 SALITERAS-Z

ceiling light; steel, black / plastic, white
Deckenleuchte; Stahl, schwarz / Kunststoff, weiss
plafonnier; acier, noir / plastique, blanc

L 1160, B 160, H 50



9 008606 221684

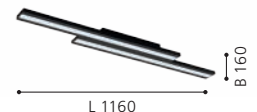



900054



900056



TURCONA-Z

Frameless luminaires
Rahmenlose Leuchten
Luminaire sans cadre



900054 TURCONA-Z

ceiling light; steel, aluminium, white / plastic, white
Deckenleuchte; Stahl, Alu, weiss / Kunststoff, weiss
plafonnier; acier, aluminium, blanc / plastique, blanc

H 60, Ø 300

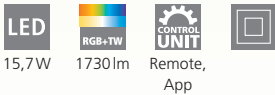

15,7W 1730lm Remote, App



9 008606 221905



900056 TURCONA-Z

ceiling light; steel, aluminium, white / plastic, white
Deckenleuchte; Stahl, Alu, weiss / Kunststoff, weiss
plafonnier; acier, aluminium, blanc / plastique, blanc

H 75, Ø 600

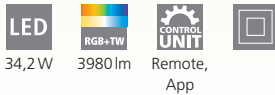

34,2W 3980lm Remote, App



9 008606 221929

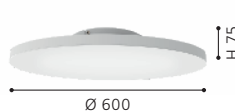

900055 TURCONA-Z

ceiling light; steel, aluminium, white / plastic, white
Deckenleuchte; Stahl, Alu, weiss / Kunststoff, weiss
plafonnier; acier, aluminium, blanc / plastique, blanc

H 75, Ø 450

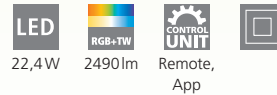

22,4W 2490lm Remote, App



9 008606 221912





900055

LED

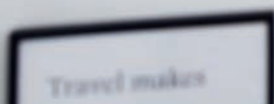



TURCONA-Z

Frameless luminaires
 Rahmenlose Leuchten
 Luminaires sans cadre

900057 TURCONA-Z

ceiling light; steel, aluminium, white / plastic, white
 Deckenleuchte; Stahl, Alu, weiss / Kunststoff, weiss
 plafonnier; acier, aluminium, blanc / plastique, blanc

L 300, B 300, H 50

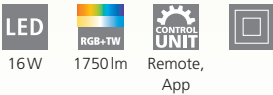

900058 TURCONA-Z

ceiling light; steel, aluminium, white / plastic, white
 Deckenleuchte; Stahl, Alu, weiss / Kunststoff, weiss
 plafonnier; acier, aluminium, blanc / plastique, blanc

L 450, B 450, H 70



900059 TURCONA-Z

ceiling light; steel, aluminium, white / plastic, white
 Deckenleuchte; Stahl, Alu, weiss / Kunststoff, weiss
 plafonnier; acier, aluminium, blanc / plastique, blanc

L 600, B 600, H 75

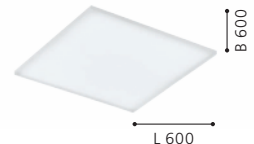
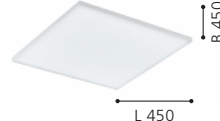
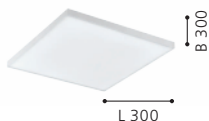



900062



900061



900062 TURCONA-Z

ceiling light; steel, aluminium, white / plastic, white
Deckenleuchte; Stahl, Alu, weiss / Kunststoff, weiss
plafonnier; acier, aluminium, blanc / plastique, blanc

L 1200, B 100, H 75

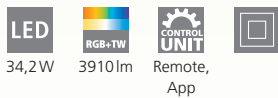

34,2W 3910lm Remote, App

900061 TURCONA-Z

ceiling light; steel, aluminium, white / plastic, white
Deckenleuchte; Stahl, Alu, weiss / Kunststoff, weiss
plafonnier; acier, aluminium, blanc / plastique, blanc

L 1200, B 300, H 75



3x 10,6W 4000lm Remote, App



9 008606 221974



9 008606 221967

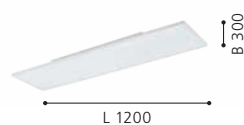



900762



900762 SARSINA-Z

ceiling light; aluminium, steel, black / plastic, white
Deckenleuchte; Alu, Stahl, schwarz / Kunststoff, weiss
plafonnier; aluminium, acier, noir / plastique, blanc

H 52, Ø 600



41 W



5800 lm



Remote,
App





900759



900761



900758



900761 SARSINA-Z

ceiling light; aluminium, steel, black / plastic, white
Deckenleuchte; Alu, Stahl, schwarz / Kunststoff, weiss
plafonnier; aluminium, acier, noir / plastique, blanc

H 52, Ø 450



33,5W 4300lm Remote, App



9 008606 264063



900759 SARSINA-Z

ceiling light; aluminium, steel, white / plastic, white
Deckenleuchte; Alu, Stahl, weiss / Kunststoff, weiss
plafonnier; aluminium, acier, blanc / plastique, blanc

H 52, Ø 600



41W 5800lm Remote, App



9 008606 264056



900758 SARSINA-Z

ceiling light; aluminium, steel, white / plastic, white
Deckenleuchte; Alu, Stahl, weiss / Kunststoff, weiss
plafonnier; aluminium, acier, blanc / plastique, blanc

H 52, Ø 450

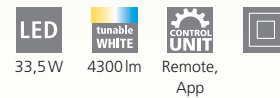

33,5W 4300lm Remote, App



9 008606 264049





900044



900045



900046



900044 SALOBRENA-Z

ceiling light; aluminium, white / plastic, white
Deckenleuchte; Alu, weiss / Kunststoff, weiss
plafonnier; aluminium, blanc / plastique, blanc

L 300, B 300, H 50



15,3W 1790lm Remote, App

900045 SALOBRENA-Z

ceiling light; aluminium, white / plastic, white
Deckenleuchte; Alu, weiss / Kunststoff, weiss
plafonnier; aluminium, blanc / plastique, blanc

L 450, B 450, H 50

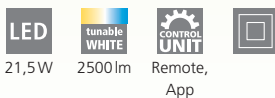

21,5W 2500lm Remote, App

900046 SALOBRENA-Z

ceiling light; aluminium, white / plastic, white
Deckenleuchte; Alu, weiss / Kunststoff, weiss
plafonnier; aluminium, blanc / plastique, blanc

L 595, B 595, H 50

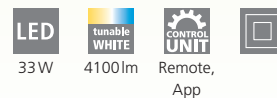

33W 4100lm Remote, App

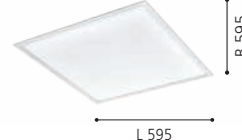
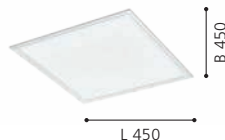
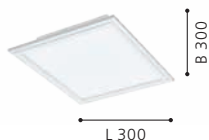



900047

LED



900048

LED



900047 SALOBRENA-Z

ceiling light; aluminium, white / plastic, white
Deckenleuchte; Alu, weiss / Kunststoff, weiss
plafonnier; aluminium, blanc / plastique, blanc

L 1200, B 300, H 50



900048 SALOBRENA-Z

ceiling light; aluminium, white / plastic, white
Deckenleuchte; Alu, weiss / Kunststoff, weiss
plafonnier; aluminium, blanc / plastique, blanc

L 1200, B 100, H 45

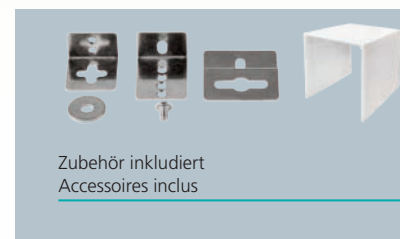
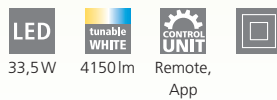

Zubehör inkludiert
Accessoires inclus



900049



900051



900052



900049 SALOBRENA-Z

ceiling light; aluminium, black / plastic, white
Deckenleuchte; Alu, schwarz / Kunststoff, weiss
plafonnier; aluminium, noir / plastique, blanc

L 300, B 300, H 50

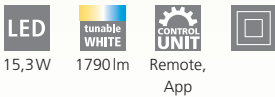

9 008606 221868



900051 SALOBRENA-Z

ceiling light; aluminium, black / plastic, white
Deckenleuchte; Alu, schwarz / Kunststoff, weiss
plafonnier; aluminium, noir / plastique, blanc

L 450, B 450, H 50



9 008606 221875



900052 SALOBRENA-Z

ceiling light; aluminium, black / plastic, white
Deckenleuchte; Alu, schwarz / Kunststoff, weiss
plafonnier; aluminium, noir / plastique, blanc

L 595, B 595, H 50

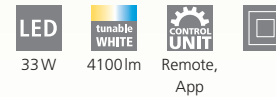

9 008606 221882





900053

LED



900095

LED



900053 SALOBRENA-Z

ceiling light; aluminium, black / plastic, white
 Deckenleuchte; Alu, schwarz / Kunststoff, weiss
 plafonnier; aluminium, noir / plastique, blanc

L 1200, B 300, H 50



900095 SALOBRENA-Z

ceiling light; aluminium, steel, black / plastic, white
 Deckenleuchte; Alu, Stahl, schwarz / Kunststoff, weiss
 plafonnier; aluminium, acier, noir / plastique, blanc

L 1200, B 100, H 45

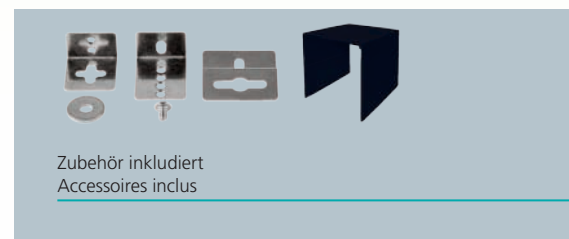
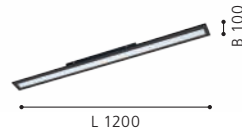
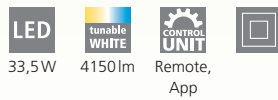

Zubehör inkludiert
 Accessoires inclus



99548



99549



99548 HERRORA-Z

ceiling light; aluminium, white / plastic, white
Deckenleuchte; Alu, weiss / Kunststoff, weiss
plafonnier; aluminium, blanc / plastique, blanc

L 595, B 595, H 40



99549 HERRORA-Z

ceiling light; aluminium, white / plastic, white
Deckenleuchte; Alu, weiss / Kunststoff, weiss
plafonnier; aluminium, blanc / plastique, blanc

L 1200, B 300, H 40



99639 HERRORA-Z

ceiling light; aluminium, white / plastic, white
Deckenleuchte; Alu, weiss / Kunststoff, weiss
plafonnier; aluminium, blanc / plastique, blanc

L 450, B 450, H 40



9 002759 995485

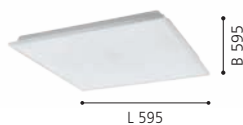

9 002759 995492

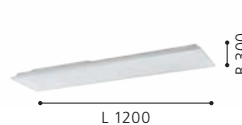

9 002759 996390

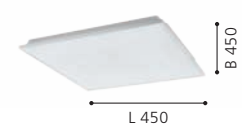



99639

LED





900099



IP20/44

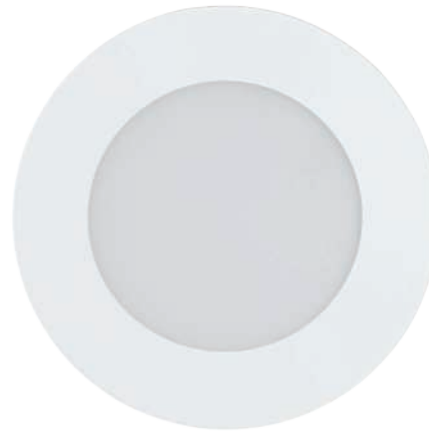

900101



IP20/44

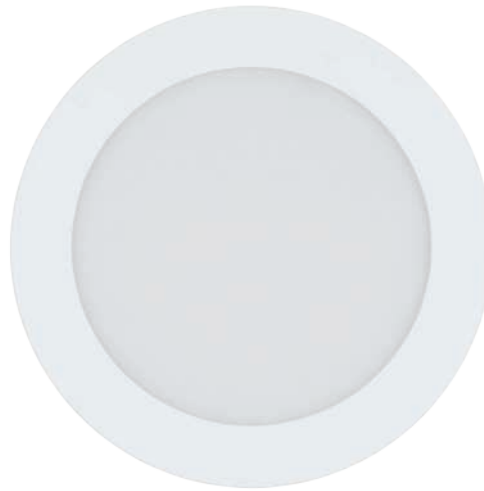

900102



IP20/44



900099 FUEVA-Z

recessed light; steel, white / plastic, white
Einbauleuchte; Stahl, weiss / Kunststoff, weiss
luminaire encastrable; acier, blanc / plastique, blanc

H 26, Ø 85



3x 2,8W



3x 390lm



Remote,
App



Ø 75



IP20/44



Ø 85

900101 FUEVA-Z

recessed light; steel, white / plastic, white
Einbauleuchte; Stahl, weiss / Kunststoff, weiss
luminaire encastrable; acier, blanc / plastique, blanc

H 26, Ø 120



5,4W



800lm



Remote,
App



Ø 105



IP20/44



Ø 120

900102 FUEVA-Z

recessed light; steel, white / plastic, white
Einbauleuchte; Stahl, weiss / Kunststoff, weiss
luminaire encastrable; acier, blanc / plastique, blanc

H 26, Ø 165



10,5W



1520lm



Remote,
App



Ø 155



IP20/44



Ø 165



98842

LED



IP20/44

98842 FUEVA-Z

recessed light; aluminium, white / plastic, white
 Einbauleuchte; Alu, weiss / Kunststoff, weiss
 luminaire encastrable; aluminium, blanc / plastique, blanc

Ø 216, ET 26



16,5W



2100lm



Remote,
App



Ø 205



IP20/44



9 002759 988425



RECESSED



Ø 216



900111



IP20/44



900112



IP20/44



900113



IP20/44



900111 FUEVA-Z

recessed light; steel, satin nickel / plastic, white
Einbauleuchte; Stahl, nickel-matt / Kunststoff, weiss
luminaire encastrable; acier, nickel mat / plastique, blanc

H 26, Ø 85



3x 2,8W



3x 390lm



Remote,
App



Ø 75



IP20/44



9 008606 225668



Ø 85

900112 FUEVA-Z

recessed light; steel, satin nickel / plastic, white
Einbauleuchte; Stahl, nickel-matt / Kunststoff, weiss
luminaire encastrable; acier, nickel mat / plastique, blanc

H 26, Ø 120



5,4W



800lm



Remote,
App



Ø 105



IP20/44



9 008606 225675



Ø 120

900113 FUEVA-Z

recessed light; steel, satin nickel / plastic, white
Einbauleuchte; Stahl, nickel-matt / Kunststoff, weiss
luminaire encastrable; acier, nickel mat / plastique, blanc

H 26, Ø 165



10,5W



1520lm



Remote,
App



Ø 155



IP20/44



9 008606 225682



Ø 165



98844



IP20/44

98844 FUEVA-Z

recessed light; aluminium, satin nickel / plastic, white
 Einbauleuchte; Alu, nickel-matt / Kunststoff, weiss
 luminaire encastrable; aluminium, nickel mat / plastique, blanc

Ø 216, ET 26



16,5W



2100lm



Remote,
App



Ø 205



IP20/44



9 002759 988449



RECESSED



Ø 216



900105



IP20/44



900106



IP20/44



98846



IP20/44



900105 FUEVA-Z

recessed light; steel, black / plastic, white
Einbauleuchte; Stahl, schwarz / Kunststoff, weiss
luminaire encastrable; acier, noir / plastique, blanc

H 26, Ø 85



3x 2,8W



3x 390lm



Remote,
App



Ø 75



IP20/44



9 008606 225613



Ø 85

900106 FUEVA-Z

recessed light; steel, black / plastic, white
Einbauleuchte; Stahl, schwarz / Kunststoff, weiss
luminaire encastrable; acier, noir / plastique, blanc

H 26, Ø 120



5,4W



800lm



Remote,
App



Ø 105



IP20/44



9 008606 225620



Ø 120

98846 FUEVA-Z

recessed light; aluminium, black / plastic, white
Einbauleuchte; Alu, schwarz / Kunststoff, weiss
luminaire encastrable; aluminium, noir / plastique, blanc

Ø 216, ET 26



16,5W



2100lm



Remote,
App



Ø 205



IP20/44



9 002759 988463



Ø 216



900107



IP20/44

900107 FUEVA-Z

recessed light; steel, black / plastic, white

Einbauleuchte; Stahl, schwarz / Kunststoff, weiss

luminaire encastrable; acier, noir / plastique, blanc

H 26, Ø 165



10,5W



1520lm



Remote,
App



Ø 155



IP20/44



9 008606 225637



Ø 165



900104



IP44



900103



IP44



98849



IP44

900104 FUEVA-Z

surface-mounted light; steel, white / plastic, white
 Aufbauleuchte; Stahl, weiss / Kunststoff, weiss
 luminaire en saillie; acier, blanc / plastique, blanc

L 210, B 210, H 28



16,5W



2250lm



Remote,
App



IP44



98849 FUEVA-Z

surface-mounted light; aluminium, white / plastic, white
 Aufbauleuchte; Alu, weiss / Kunststoff, weiss
 luminaire en saillie; aluminium, blanc / plastique, blanc

L 285, B 285, H 28



19,5W



2500lm



Remote,
App



IP44



900103 FUEVA-Z

surface-mounted light; steel, white / plastic, white
 Aufbauleuchte; Stahl, weiss / Kunststoff, weiss
 luminaire en saillie; acier, blanc / plastique, blanc

H 28, Ø 210



16,5W



2250lm



Remote,
App



IP44



9 008606 225606

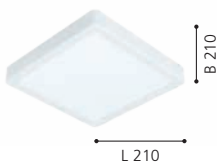

9 002759 988494

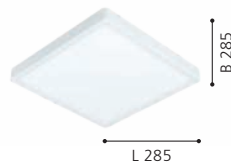

9 008606 225590

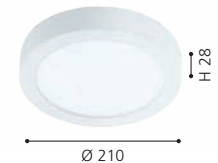



98843 FUEVA-Z

surface-mounted light; aluminium, white / plastic, white
Aufbauleuchte; Alu, weiss / Kunststoff, weiss
luminaire en saillie; aluminium, blanc / plastique, blanc

H 28, Ø 285

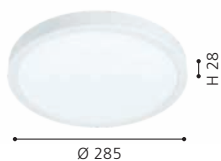
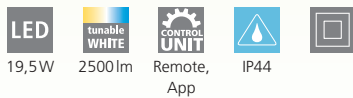

98843



IP44



900114



IP44



900115



IP44



98845



IP44

900114 FUEVA-Z

surface-mounted light; steel, satin nickel / plastic, white
Aufbauleuchte; Stahl, nickel-matt / Kunststoff, weiss
luminaire en saillie; acier, nickel mat / plastique, blanc

H 28, Ø 210



16,5W



2250lm



Remote,
App



IP44



98845 FUEVA-Z

surface-mounted light; aluminium, satin nickel / plastic, white
Aufbauleuchte; Alu, nickel-matt / Kunststoff, weiss
luminaire en saillie; aluminium, nickel mat / plastique, blanc

H 28, Ø 285



19,5W



2500lm



Remote,
App



IP44



900115 FUEVA-Z

surface-mounted light; steel, satin nickel / plastic, white
Aufbauleuchte; Stahl, nickel-matt / Kunststoff, weiss
luminaire en saillie; acier, nickel mat / plastique, blanc

L 210, B 210, H 28



16,5W



2250lm



Remote,
App



IP44



9 008606 225699



9 002759 988456



9 008606 225705

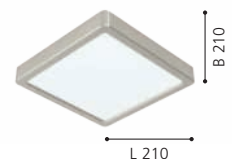



98852 FUEVA-Z

surface-mounted light; aluminium, satin nickel / plastic, white
Aufbauleuchte; Alu, nickel-matt / Kunststoff, weiss
luminaire en saillie; aluminium, nickel mat / plastique, blanc

L 285, B 285, H 28

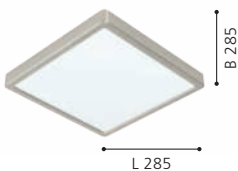
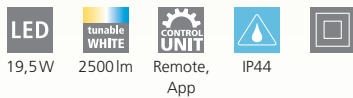

98852



IP44



900108



98854



98847



900108 FUEVA-Z

surface-mounted light; steel, black / plastic, white
Aufbauleuchte; Stahl, schwarz / Kunststoff, weiss
luminaire en saillie; acier, noir / plastique, blanc

H 28, Ø 210

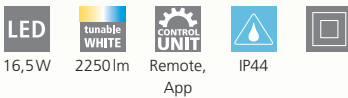

16,5W 2250lm Remote, App

98847 FUEVA-Z

surface-mounted light; aluminium, black / plastic, white
Aufbauleuchte; Alu, schwarz / Kunststoff, weiss
luminaire en saillie; aluminium, noir / plastique, blanc

H 28, Ø 285

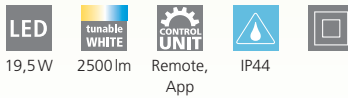

19,5W 2500lm Remote, App

98854 FUEVA-Z

surface-mounted light; aluminium, black / plastic, white
Aufbauleuchte; Alu, schwarz / Kunststoff, weiss
luminaire en saillie; aluminium, noir / plastique, blanc

L 285, B 285, H 28

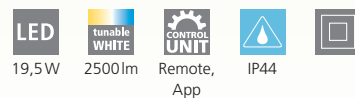

19,5W 2500lm Remote, App



9 008606 225644



Ø 210



9 002759 988470



Ø 285



9 002759 988548



L 285



900109 FUEVA-Z

surface-mounted light; steel, black / plastic, white
Aufbauleuchte; Stahl, schwarz / Kunststoff, weiss
luminaire en saillie; acier, noir / plastique, blanc

L 210, B 210, H 28

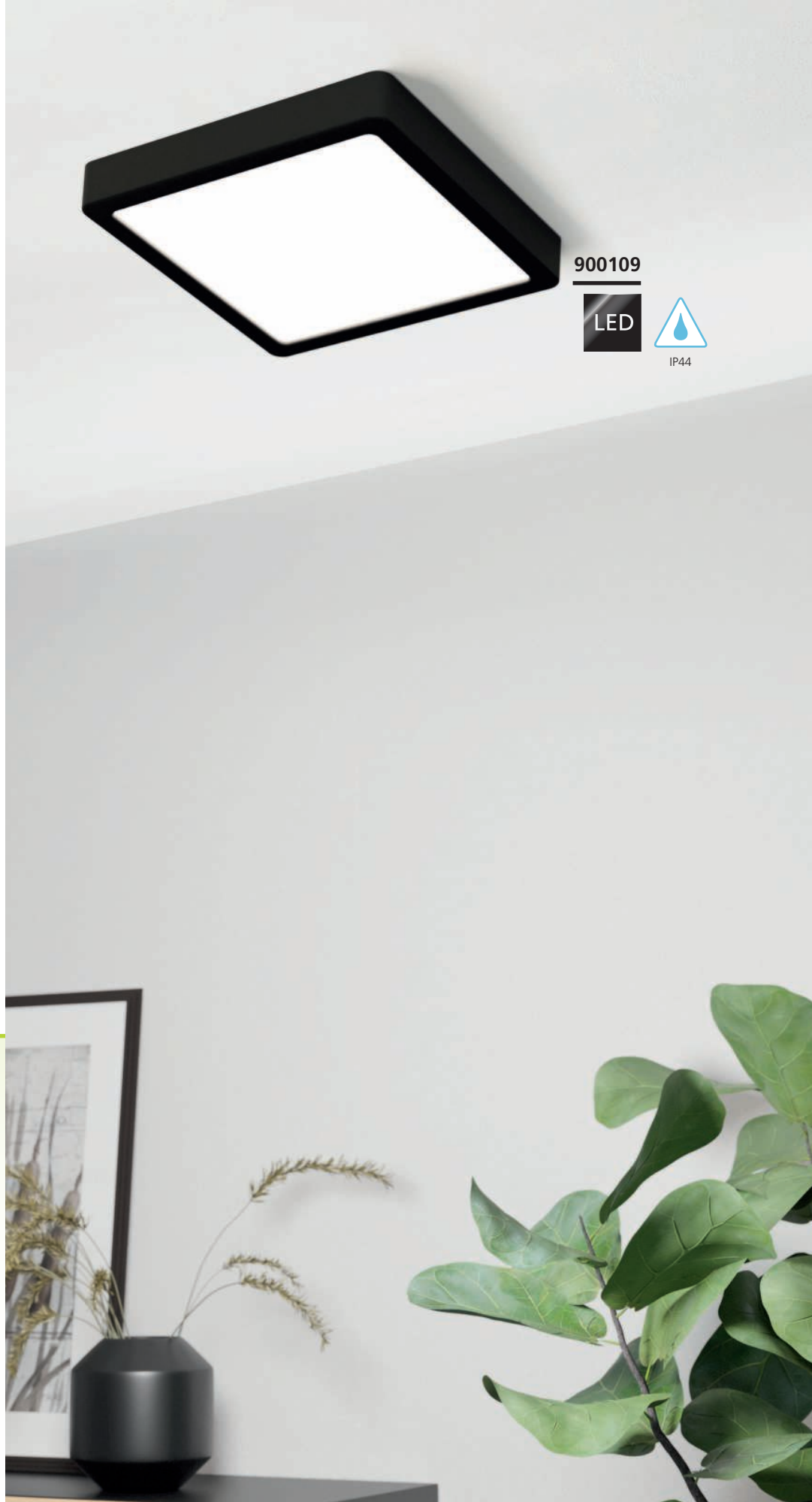
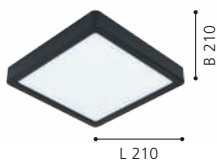
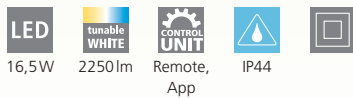

900109



IP44



900001



900002



900636



IP44

900001 TOTARI-Z

ceiling light; steel, white / plastic with crystal effect, white
Deckenleuchte; Stahl, weiss / Kunststoff m. Kristalleffekt, weiss
plafonnier; acier, blanc / plastique avec effet cristal, blanc

H 70, Ø 380



4x 4,8W



2160lm



Remote,
App



900002 TOTARI-Z

ceiling light; steel, white / plastic with crystal effect, white
Deckenleuchte; Stahl, weiss / Kunststoff m. Kristalleffekt, weiss
plafonnier; acier, blanc / plastique avec effet cristal, blanc

H 70, Ø 530



4x 11,2W



4960lm



Remote,
App



900636 TOTARI-Z

ceiling light; steel, white / plastic with crystal effect, white
Deckenleuchte; Stahl, weiss / Kunststoff m. Kristalleffekt, weiss
plafonnier; acier, blanc / plastique avec effet cristal, blanc

H 70, Ø 380



4x 4,8W



2160lm



Remote,
App



IP44



9 008606 221479

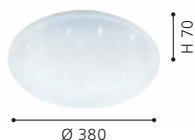

9 008606 221486



9 008606 245208





900084

LED



900085

LED

900084 TOTARI-Z

ceiling light; steel, white / plastic, white
Deckenleuchte; Stahl, weiss / Kunststoff, weiss
plafonnier; acier, blanc / plastique, blanc

H 70, Ø 380



4x 4,8W



2160lm



Remote,
App



9 008606 225453

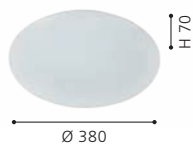

900085 TOTARI-Z

ceiling light; steel, white / plastic, white
Deckenleuchte; Stahl, weiss / Kunststoff, weiss
plafonnier; acier, blanc / plastique, blanc

H 70, Ø 530



4x 11,2W



4960lm



Remote,
App



9 008606 225460





900083



900005



900006



900083 LANCIANO-Z

ceiling light; steel, white, transparent / plastic with crystal effect, white, chrome

Deckenleuchte; Stahl, weiss, transparent / Kunststoff m.Kristalleffekt, weiss, chrom

plafonnier; acier, blanc, transparent / plastique avec effet cristal, blanc, chrome
H 80, Ø 450



4x 4,8W



2160lm



Remote,
App



900005 LANCIANO-Z

ceiling light; steel, white, transparent / plastic with crystal effect, white, chrome

Deckenleuchte; Stahl, weiss, transparent / Kunststoff m.Kristalleffekt, weiss, chrom

plafonnier; acier, blanc, transparent / plastique avec effet cristal, blanc, chrome
H 80, Ø 560



4x 11,2W



4960lm



Remote,
App



900006 LANCIANO-Z

ceiling light; steel, white, transparent / plastic with crystal effect, white, chrome

Deckenleuchte; Stahl, weiss, transparent / Kunststoff m.Kristalleffekt, weiss, chrom

plafonnier; acier, blanc, transparent / plastique avec effet cristal, blanc, chrome
H 95, Ø 770



38,1W



5350lm



Remote,
App



9 008606 225446



9 008606 221516

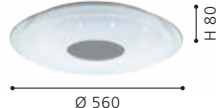

9 008606 221523





900128



900129



900128 SILERAS-Z

ceiling light; steel, white / plastic with crystal effect, white
Deckenleuchte; Stahl, weiss / Kunststoff m.Kristalleffekt, weiss
plafonnier; acier, blanc / plastique avec effet cristal, blanc

H 60, Ø 430



3x 7,2 W



2700 lm



Remote,
App



900129 SILERAS-Z

ceiling light; steel, white / plastic with crystal effect, white
Deckenleuchte; Stahl, weiss / Kunststoff m.Kristalleffekt, weiss
plafonnier; acier, blanc / plastique avec effet cristal, blanc

H 60, Ø 600



3x 11 W



4050 lm



Remote,
App



9 008606 226054



9 008606 226061

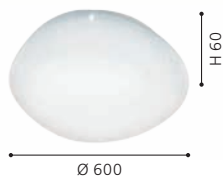



900336

LED



900337

LED



900338

LED



DIMMABLE
VIA REMOTE
AND APP

900336 TELIMBELA-Z

spot; steel, black
Spot; Stahl, schwarz
spot; acier, noir

H 97, Ø 250



GU10



3x 4,9W



3x
345lm



Remote,
App



900337 TELIMBELA-Z

spot; steel, black
Spot; Stahl, schwarz
spot; acier, noir

L 580, B 80, H 97



GU10



4x 4,9W



4x
345lm



Remote,
App



900338 TELIMBELA-Z

spot; steel, white
Spot; Stahl, weiss
spot; acier, blanc

H 97, Ø 250



GU10



3x 4,9W



3x
345lm



Remote,
App



9 008606 239948



9 008606 239955



9 008606 239962





900339

LED

900339 TELIMBELA-Z

spot; steel, white
Spot; Stahl, weiss
spot; acier, blanc

L 580, B 80, H 97



GU10



4x 4,9W



4x
345 lm



Remote,
App



9 008606 239979



INCL.

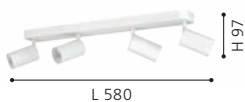



99673

LED



99674

LED



99675

LED



99673 CAMINALES-Z

ceiling light; steel, black
Deckenleuchte; Stahl, schwarz
plafonnier; acier, noir

L 125, B 125, H 120

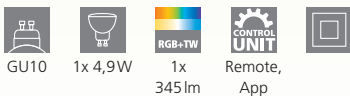

99674 CAMINALES-Z

ceiling light; steel, black
Deckenleuchte; Stahl, schwarz
plafonnier; acier, noir

L 240, B 125, H 120

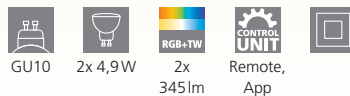

99675 CAMINALES-Z

ceiling light; steel, black
Deckenleuchte; Stahl, schwarz
plafonnier; acier, noir

L 240, B 240, H 120

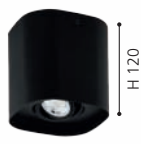
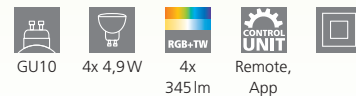

L 125



L 240



L 240



99669



99671



99672



99669 SALICETO-Z

recessed light; aluminium, black
Einbauleuchte; Alu, schwarz
luminaire encastrable; aluminium, noir

H 46, Ø 88, ET 50

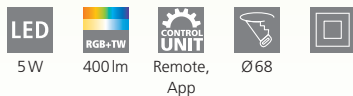

99671 SALICETO-Z

recessed light; aluminium, white
Einbauleuchte; Alu, weiss
luminaire encastrable; aluminium, blanc

H 46, Ø 88, ET 50

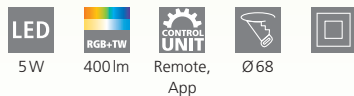

99672 SALICETO-Z

recessed light; aluminium, satin nickel
Einbauleuchte; Alu, nickel-matt
luminaire encastrable; aluminium, nickel mat

H 46, Ø 88, ET 50

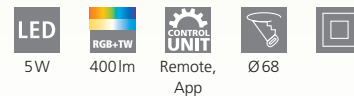



900763

LED



900765

LED

900763 CAROSSO-Z

recessed light; aluminium, black / plastic, white
 Einbauleuchte; Alu, schwarz / Kunststoff, weiss
 luminaire encastrable; aluminium, noir / plastique, blanc

L 93, B 93, H 25

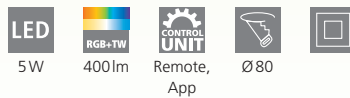

900765 CAROSSO-Z

recessed light; aluminium, white / plastic, white
 Einbauleuchte; Alu, weiss / Kunststoff, weiss
 luminaire encastrable; aluminium, blanc / plastique, blanc

L 93, B 93, H 25

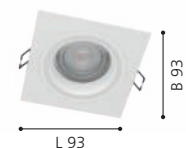
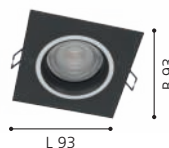
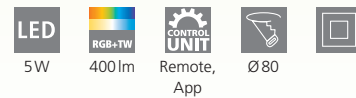



900766



900764



900766 CAROSSO-Z

recessed light; aluminium, white / plastic, white
 Einbauleuchte; Alu, weiss / Kunststoff, weiss
 luminaire encastrable; aluminium, blanc / plastique, blanc

H 28, Ø 93

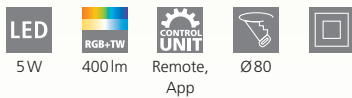

900764 CAROSSO-Z

recessed light; aluminium, black / plastic, white
 Einbauleuchte; Alu, schwarz / Kunststoff, weiss
 luminaire encastrable; aluminium, noir / plastique, blanc

H 28, Ø 93

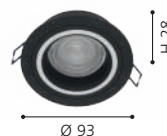
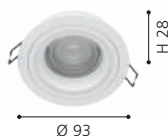
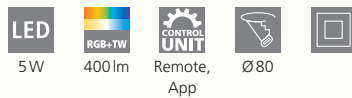

99684

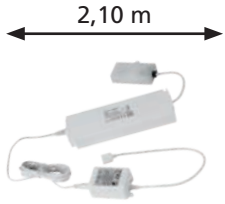

Driver included
Treiber inkludiert
Chauffeur inclus



99684



99685

Extension for starter set 99684 without driver
Erweiterung für Starterset 99684 ohne Treiber
Rallonge pour kit de démarrage 99684 sans pilote



99685



99684 LED STRIPE-Z

bar/strip light; plastic, white
Leuchtband/-stab; Kunststoff, weiss
bande lumineuse / bâton l; plastique, blanc

L 3000, B 8



L 3000

99685 LED STRIPE-Z

bar/strip light; plastic, white
Leuchtband/-stab; Kunststoff, weiss
bande lumineuse / bâton l; plastique, blanc

L 2000, B 8



L 2000

99686

Driver included
Treiber inkludiert
Chauffeur inclus



1,50 m

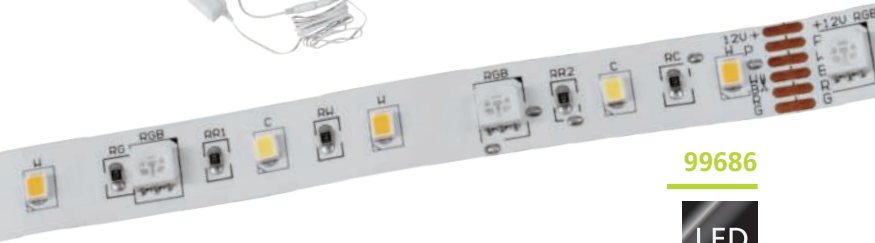

99686

LED

99687

Driver included
Treiber inkludiert
Chauffeur inclus



3,40 m



99687

LED



99686 LED STRIPE-Z

bar/strip light; plastic, white
Leuchtband/-stab; Kunststoff, weiss
bande lumineuse / bâton l; plastique, blanc

L 5000, B 12

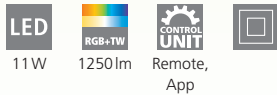

11W 1250lm Remote, App



9 002759 996864



L 5000

99687 LED STRIPE-Z

bar/strip light; plastic, white
Leuchtband/-stab; Kunststoff, weiss
bande lumineuse / bâton l; plastique, blanc

L 8000, B 12

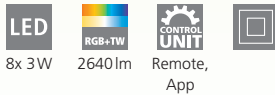

8x 3W 2640lm Remote, App



9 002759 996871



L 8000



EGLO CONNECT.Z ILLUMINANT

One illuminant – numerous possibilities: 16.7 million colours and over 50,000 white tones ensure the right atmosphere in your home at all times. The illuminant can be controlled via remote control or app using Bluetooth technology: You can control the brightness or adjust colour tones – and all this without complicated installation and comfortably from the sofa.

But the illuminant can do much more: it can be expanded at will using intelligent mesh technology, and up to 50 illuminants can be grouped together. This makes it easy to create and program a wide variety of lighting scenarios. You can also use the app to select from a large number of pre-set lighting scenes.

Security is not neglected either, as the illuminants form a self-contained network and are therefore protected from external access.

EGLO CONNECT.Z LEUCHTMITTEL

Ein Leuchtmittel – zahlreiche Möglichkeiten: 16,7 Millionen Farben und über 50.000 Weißtöne sorgen jederzeit für die richtige Stimmung in Ihrem Heim. Über die Bluetooth-Technologie kann das Leuchtmittel per Fernbedienung oder App gesteuert werden: Sie können die Helligkeit kontrollieren oder Farbtöne einstellen – und das alles ohne aufwändige Installation und bequem vom Sofa aus.

Aber das Leuchtmittel kann noch viel mehr: es lässt sich per intelligenter Mesh-Technologie beliebig erweitern, bis zu 50 Leuchtmittel sind hierbei gruppierbar. So lassen sich problemlos und einfach unterschiedlichste Lichtszenarien erstellen und programmieren. Mit der App können Sie aber auch aus einer Vielzahl vorgegebener Lichtstimmungen auswählen.

Auch die Sicherheit kommt nicht zu kurz, denn die Leuchtmittel bilden ein in sich geschlossenes Netzwerk und sind somit vor Zugriffen von Außen geschützt.

AMPOULE EGLO CONNECT.Z











Une seule ampoule – de nombreuses possibilités : 16,7 millions de couleurs et plus de 50 000 tons de blanc assurent à tout moment la bonne ambiance dans votre maison. L'ampoule peut être commandée via une télécommande ou une appli, utilisant la technologie Bluetooth : Vous pouvez contrôler la luminosité ou régler les tons de couleurs – et tout cela sans installation compliquée et de manière confortablement depuis votre canapé.

Mais l'ampoule peut faire beaucoup plus : elle peut être étendue à volonté grâce à la technologie Mesh intelligentes, et jusqu'à 50 ampoules peuvent être regroupées. Il est ainsi facile de créer et de programmer une grande variété de scène lumineuse. Vous pouvez également utiliser l'appli pour sélectionner un grand nombre d'ambiance lumineuse prédéfinies.

La sécurité n'est pas négligée non plus, car les ampoules forment un réseau fermé et sont donc protégées des accès externes.



12253 E27-LED-A60

 806 lm	 RGB+TW	 A++ F
 L 118, Ø 60	 dimmable via remote & app	
 9 W	 15000 h	
 220-240V, 50/60Hz	 9 W ~ 60 W	
 E27	 80 CRI	





12254 E27-LED-G95



1300 lm



2700-6500 K



L 142, Ø 95



dimmable via remote & app



13.5 W



15000 h



220-240V,50/60Hz



13.5 W ~ 88 W



E27



80 CRI



12252 E14-LED-P45



470 lm



2700-6500 K



L 92, Ø 45



dimmable via remote & app



4.9 W



15000 h



220-240V,50/60Hz



4.9 W ~ 35 W



E14



80 CRI



12251 GU10-LED



345 lm



2700-6500 K



L 59, Ø 50



dimmable via remote & app



45°



4.9 W



15000 h



220-240V,50/60Hz



4.9 W ~ 50 W



GU10



83 CRI



12226 E27-LED-A60



806 lm	warm WHITE	2700 K	E
L 105, Ø 60	dimmable via remote & app		
6 W	15000 h		
220-240V, 50/60Hz	6 W ~ 60 W		
E27	80 CRI		



12227 E27-LED-ST64



806 lm	warm WHITE	2700 K	E
L 142, Ø 64	dimmable via remote & app		
6 W	15000 h		
220-240V, 50/60Hz	6 W ~ 60 W		
E27	80 CRI		



12228 E27-LED-G80



806 lm	warm WHITE	2700 K	E
L 120, Ø 80	dimmable via remote & app		
6 W	15000 h		
220-240V, 50/60Hz	6 W ~ 60 W		
E27	80 CRI		







12229 E27-LED-G95

 806 lm	warm WHITE	2700 K	
---	-------------------	---------------	---

 L 140, Ø 95

 dimmable via remote & app

 6 W

 15000 h

 220-240V,50/60Hz

 6 W ~ 60 W

 E27

 80 CRI



12231 E27-LED-A60

 806 lm	neutral WHITE	4000 K	
---	----------------------	---------------	---

 L 105, Ø 60

 dimmable via remote & app

 6 W

 15000 h

 220-240V,50/60Hz

 6 W ~ 60 W

 E27

 80 CRI



12232 E27-LED-ST64

 806 lm	neutral WHITE	4000 K	
---	----------------------	---------------	---

 L 142, Ø 64

 dimmable via remote & app

 6 W

 15000 h

 220-240V,50/60Hz

 6 W ~ 60 W

 E27

 80 CRI



12233 E27-LED-G80



806 lm	neutral WHITE	4000 K	E
L 120, Ø 80	dimmable via remote & app		
6 W	15000 h		
220-240V, 50/60Hz	6 W ~ 60 W		
E27	80 CRI		



12234 E27-LED-G95



806 lm	neutral WHITE	4000 K	E
L 140, Ø 95	dimmable via remote & app		
6 W	15000 h		
220-240V, 50/60Hz	6 W ~ 60 W		
E27	80 CRI		



12235 E27-LED-A60













806 lm	tunable WHITE	2200-6500 K	E
L 105, Ø 60	dimmable via remote & app		
6 W	15000 h		
220-240V, 50/60Hz	6 W ~ 60 W		
E27	80 CRI		



12236 E27-LED-ST64













 806 lm	 2200-6500 K	
 L 142, Ø 64	 dimmable via remote & app	
 6 W	 15000 h	
 220-240V,50/60Hz	 6 W ~ 60 W	
 E27	 80 CRI	



12237 E27-LED-G80













 806 lm	 2200-6500 K	
 L 120, Ø 80	 dimmable via remote & app	
 6 W	 15000 h	
 220-240V,50/60Hz	 6 W ~ 60 W	
 E27	 80 CRI	



12239 E27-LED-G95



 806 lm	 2200-6500 K	
 L 140, Ø 95	 dimmable via remote & app	
 6 W	 15000 h	
 220-240V,50/60Hz	 6 W ~ 60 W	
 E27	 80 CRI	



12221 E27-LED-A60



500 lm	warm WHITE	2200 K	F
L 105, Ø 60	dimmable via remote & app		
4.9 W	15000 h		
220-240V, 50/60Hz	4.9 W ~ 42 W		
E27	80 CRI		



12222 E27-LED-ST64



500 lm	warm WHITE	2200 K	F
L 142, Ø 64	dimmable via remote & app		
4.9 W	15000 h		
220-240V, 50/60Hz	4.9 W ~ 42 W		
E27	80 CRI		



12223 E27-LED-G80



500 lm	warm WHITE	2200 K	F
L 120, Ø 80	dimmable via remote & app		
4.9 W	15000 h		
220-240V, 50/60Hz	4.9 W ~ 42 W		
E27	80 CRI		





12224 E27-LED-G95

500 lm	warm WHITE 2200 K	A+ G F
---------------	---------------------------------	---------------

L 140, Ø 95	dimmable via remote & app
4.9 W	15000 h
220-240V,50/60Hz	4.9 W ~ 42 W
E27	80 CRI



12225 E27-LED-G125

650 lm	warm WHITE 2200 K	A+ G F
---------------	---------------------------------	---------------

L 172, Ø 125	dimmable via remote & app
6 W	15000 h
220-240V,50/60Hz	6 W ~ 51 W
E27	80 CRI



12241 E27-LED-A60



360 lm	tunable WHITE	2200-6500 K	A ↑ G
L 105, Ø 60	dimmable via remote & app		
4.9 W	15000 h		
220-240V, 50/60Hz	4.9 W ~ 33 W		
E27	80 CRI		



12242 E27-LED-ST64



360 lm	tunable WHITE	2200-6500 K	A ↑ G
L 142, Ø 64	dimmable via remote & app		
4.9 W	15000 h		
220-240V, 50/60Hz	4.9 W ~ 33 W		
E27	80 CRI		



12243 E27-LED-G80



360 lm	tunable WHITE	2200-6500 K	A ↑ G
L 120, Ø 80	dimmable via remote & app		
4.9 W	15000 h		
220-240V, 50/60Hz	4.9 W ~ 33 W		
E27	80 CRI		



12244 E27-LED-G95





 **360 lm**

 **2200-6500 K**



 L 140, Ø 95

 dimmable via remote & app

 4.9 W

 15000 h

 220-240V,50/60Hz

 4.9 W ~ 33 W

 E27

 80 CRI



12245 E27-LED-G125





 **360 lm**

 **2200-6500 K**





 L 170, Ø 125

 dimmable via remote & app

 4.9 W

 15000 h

 220-240V,50/60Hz

 4.9 W ~ 33 W

 E27

 80 CRI



WARM WHITE



COLD WHITE

12255 E27-LED-A60



806 lm	neutral WHITE	4000 K	E
L 105, Ø 60	dimmable via remote & app	2 x AAA Battery included	
6 W	15000 h		
220-240V, 50/60Hz	6 W ~ 60 W		
E27	80 CRI		



12256 E27-LED-ST64



500 lm	warm WHITE	2200 K	F
L 142, Ø 64	dimmable via remote & app	2 x AAA Battery included	
4.9 W	15000 h		
220-240V, 50/60Hz	4.9 W ~ 42 W		
E27	80 CRI		



12257 E27-LED-A60



806 lm	neutral WHITE	4000 K	E
L 105, Ø 60	dimmable via remote & app	3 x AA Battery included	
6 W	15000 h		
220-240V, 50/60Hz	6 W ~ 60 W		
E27	80 CRI		



12258 E27-LED-ST64



500 lm

warm
WHITE

2200 K



L 142, Ø 64



dimmable via
remote & app



3 x AA
Battery included



4.9 W



15000 h



220-240V, 50/60Hz



4.9 W ~ 42 W



E27



80 CRI



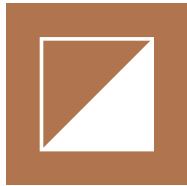

EGLO ACCESS

EGLO ACCESS
EGLO ACCESS



EN EGLO ACCESS

Light influences our lives and our work. For example, bright neutral white light improves focus, while warm, dimmed light makes us feel comfortable. You can adjust your EGLO Access luminaires to your requirements or mood.

DE EGLO ACCESS

Licht beeinflusst unser Leben und unsere Tätigkeiten. Zum Beispiel fördert helles, neutralweißes Licht die Konzentration, wohingegen warmes, gedimmtes Licht uns ein Gefühl von Behaglichkeit gibt. Je nach Anforderung oder Stimmung können Sie Ihre EGLO Access Leuchte individuell einstellen.

FR EGLO ACCÈS

La lumière influence nos vies et nos activités. Par exemple, une lumière blanche brillante et neutre favorise la concentration, tandis qu'une lumière chaude et atténuée nous procure une sensation de confort. En fonction de vos besoins ou de votre humeur, vous pouvez régler votre éclairage EGLO Access.





OVERVIEW

EGLO ACCESS
EGLO ACCESS
EGLO ACCESS



ZUBIETA-A
120-122



FRANIA-A
123



SARSINA-A
124



SALOBRENA-A
126-127



FUEVA-A
128



This product is available in different colors and shapes. / Dieser Artikel ist in unterschiedlichen Farben und Formen verfügbar. /
Cet article est disponible en différentes couleurs et formes.





LET LIGHT FOLLOW YOUR LIFE

DAS LICHT, DAS SICH IHREM LEBEN ANPASST
LA LUMIÈRE QUE S'ADAPTE À VOTRE VIE



- › One remote control for different light scenarios
- › 4-predefined settings
- › Tunable white: individually adjustable from warm white to cold white
- › Dimmable with incl. remote control
- › 2 memory functions for individual light

- › Eine Fernbedienung für verschiedene Lichtszenarien
- › 4 vordefinierte Einstellungen
- › Tunable white: individuell einstellbar von Warmweiß bis Kaltweiß
- › Dimmbar mit inkludierter Fernbedienung
- › 2 Speicherfunktionen für individuelles Licht

- › Une seule télécommande pour différents scénarios d'éclairage
- › 4 paramètres prédéfinis à l'emploi
- › Tunable white : réglable individuellement du blanc chaud au blanc froid
- › Graduable avec télécommande incluse
- › 2 fonctions mémoire pour un éclairage individuel

THE SYSTEM'S ADVANTAGES ARE:

DIE VORTEILE DES SYSTEMS SIND:

LES AVANTAGES DU SYSTÈME SONT :



Quick and simple installation

Schnelle und einfache Installation

Installation simple et rapide



One remote control for up to 8 different items and a control distance up to 10 meters.

Eine Fernbedienung für bis zu 8 verschiedene Artikel und steuerbar bis zu 10 Meter

Une seule télécommande pour jusqu'à 8 articles différents et contrôlable jusqu'à 10 mètres



Light colour from 2700K to 6500K

Lichtfarbe von 2700K bis 6500K

Couleur de lumière de 2 700 K à 6 500 K



No internet access necessary

Kein Internetzugang erforderlich

Aucun accès internet nécessaire

FUNCTIONS

FUNKTIONEN FONCTIONS

Relax with warm light and leave the hustle and bustle of everyday life behind you. Concentrate on your work or dispel fatigue, with neutral white light the energy level is replenished. EGLO Access offers these possibilities and many more. All functions and highlights at a glance:

- › It works with radio frequency technology and allows 360 degree control
- › Controllable up to a distance of 10 meters
- › Up to 8 different items can be connected
- › Easy handling thanks to 4 ready-made settings and 2 memory functions

NIGHT LIGHT

RELAX MODE

WORK MODE

SWITCH OFF AFTER 30 MINUTES

Mit warmem Licht entspannen und die Hektik des Alltages hinter sich lassen. Konzentriert arbeiten oder die Müdigkeit vertreiben, mit neutralweißem Licht wird das Energielevel wieder aufgefüllt. Diese Möglichkeiten und noch viele mehr bietet Ihnen EGLO Access. Alle Funktionen und Highlights auf einem Blick:

- › Es arbeitet mit Funktechnologie und ermöglicht eine 360-Grad-Steuerung
- › Steuerbar bis zu einer Entfernung von 10 Metern
- › Bis zu 8 verschiedene Artikel können miteinander verbunden werden
- › Einfache Handhabung durch 4 vorgefertigte Einstellungen und 2 Speicherfunktionen

NACHTLICHT

ENTSPANNUNGSMODUS

ARBEITSMODUS

AUSSCHALTEN NACH 30 MINUTEN

Lumière chaude pour se détendre et laisser l'agitation quotidienne derrière soi. Travailler de manière concentrée ou chasser la fatigue, avec une lumière blanche neutre, le niveau d'énergie est rétabli. EGLO Access vous offre ces possibilités et bien d'autres encore. Toutes les fonctions et les points forts en un coup d'œil :

- › Il fonctionne avec la technologie de la fréquence radio et permet un contrôle à 360 degrés
- › Contrôlable jusqu'à une distance de 10 mètres
- › Jusqu'à 8 articles différents peuvent être connectés ensemble
- › Manipulation facile grâce à 4 réglages prêts à l'emploi et 2 fonctions mémoire

VEILLEUSE

MODE DE DÉCOMPRESSION

MODE DE TRAVAIL

EXTINCTION APRÈS 30 MINUTES

COLOUR TEMPERATURES SCALE / FARBTEMPERATUREN SKALA / ÉCHELLE DES TEMPÉRATURES DE COULEUR



REMOTE CONTROL

FERNBEDIENUNG
TÉLÉCOMMANDE

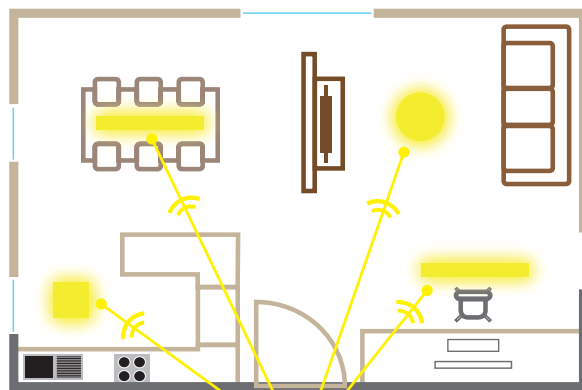
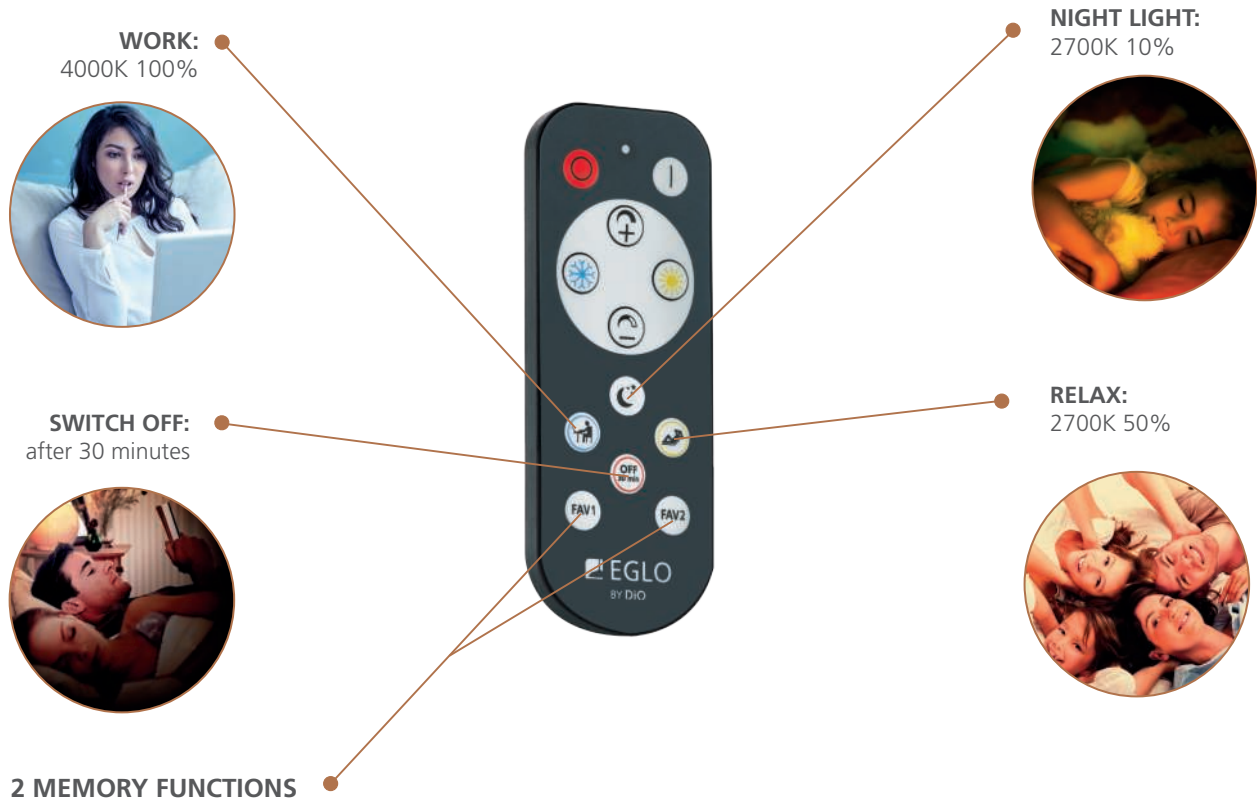

no internet necessary
kein Internet erforderlich
nul besoin d'internet



Control up to 8 EGLO Access luminaires
Bis zu 8 EGLO Access Leuchten steuerbar
Contrôle jusqu'à 8 luminaires EGLO Access



98894

LED



incl./inkl./inclus

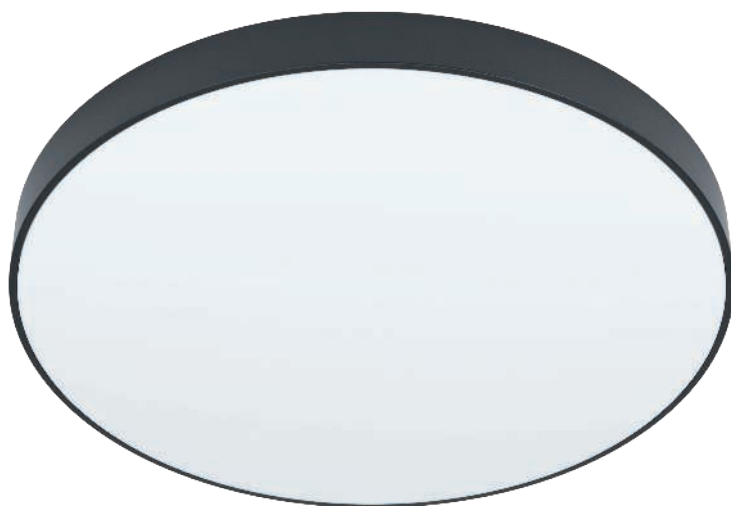

98895

LED



incl./inkl./inclus

98894 ZUBIETA-A

surface-mounted light; steel, black / plastic, white
Aufbauleuchte; Stahl, schwarz / Kunststoff, weiss
luminaire en saillie; acier, noir / plastique, blanc

H 40, Ø 300



14,6W



1900lm



Remote

98895 ZUBIETA-A

surface-mounted light; steel, black / plastic, white
Aufbauleuchte; Stahl, schwarz / Kunststoff, weiss
luminaire en saillie; acier, noir / plastique, blanc

H 40, Ø 450



18,8W



2300lm



Remote

98896 ZUBIETA-A

surface-mounted light; steel, black / plastic, white
Aufbauleuchte; Stahl, schwarz / Kunststoff, weiss
luminaire en saillie; acier, noir / plastique, blanc

H 40, Ø 595



32W



3900lm



Remote



9 002759 988944



Ø 300



9 002759 988951



Ø 450



9 002759 988968



Ø 595



98896

LED

incl./inkl./inclus





98892



98891



98893



98891 ZUBIETA-A

surface-mounted light; steel, white / plastic, white
Aufbauleuchte; Stahl, weiss / Kunststoff, weiss
luminaire en saillie; acier, blanc / plastique, blanc

H 40, Ø 300



14,6W



1900lm



Remote

98892 ZUBIETA-A

surface-mounted light; steel, white / plastic, white
Aufbauleuchte; Stahl, weiss / Kunststoff, weiss
luminaire en saillie; acier, blanc / plastique, blanc

H 40, Ø 450



18,8W



2300lm



Remote

98893 ZUBIETA-A

surface-mounted light; steel, white / plastic, white
Aufbauleuchte; Stahl, weiss / Kunststoff, weiss
luminaire en saillie; acier, blanc / plastique, blanc

H 40, Ø 595



32W



3900lm



Remote



9 002759 988913



9 002759 988920

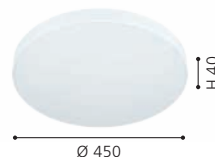

9 002759 988937

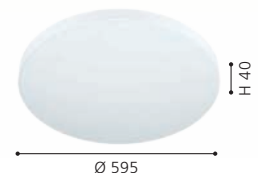



98294



IP44



incl./inkl./inclus



98236



incl./inkl./inclus



98237



incl./inkl./inclus

98294 FRANIA-A

wall/ceiling light; steel, white / plastic with crystal effect, white
Wand- / Deckenleuchte; Stahl, weiss / Kunststoff m.Kristalleffekt, weiss

Applique/Plafonnier; acier, blanc / plastique avec effet cristal, blanc

H 55, Ø 300



98236 FRANIA-A

wall/ceiling light; steel, white / plastic with crystal effect, white
Wand- / Deckenleuchte; Stahl, weiss / Kunststoff m.Kristalleffekt, weiss

Applique/Plafonnier; acier, blanc / plastique avec effet cristal, blanc

H 55, Ø 400



98237 FRANIA-A

wall/ceiling light; steel, white / plastic with crystal effect, white
Wand- / Deckenleuchte; Stahl, weiss / Kunststoff m.Kristalleffekt, weiss

Applique/Plafonnier; acier, blanc / plastique avec effet cristal, blanc

H 75, Ø 570



9 002759 982942

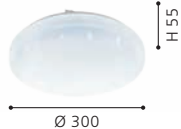

9 002759 982362

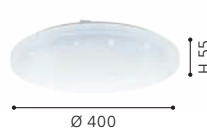

9 002759 982379

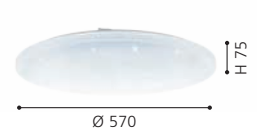



98207



incl./inkl./inclus



98208



incl./inkl./inclus

98207 SARSINA-A

ceiling light; aluminium, white / plastic, white
Deckenleuchte; Alu, weiss / Kunststoff, weiss
plafonnier; aluminium, blanc / plastique, blanc

H 50, Ø 300



14W



2000lm



Remote



98208 SARSINA-A

ceiling light; aluminium, white / plastic, white
Deckenleuchte; Alu, weiss / Kunststoff, weiss
plafonnier; aluminium, blanc / plastique, blanc

H 50, Ø 450



21,5W



2850lm



Remote



98209 SARSINA-A

ceiling light; aluminium, white / plastic, white
Deckenleuchte; Alu, weiss / Kunststoff, weiss
plafonnier; aluminium, blanc / plastique, blanc

H 50, Ø 600



30W



4000lm



Remote



9 002759 982072

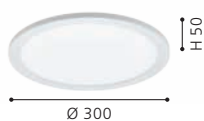

9 002759 982089



9 002759 982096

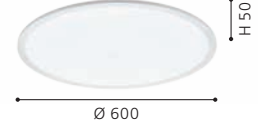



98209

LED

incl./inkl./inclus





98205



98206



98205 SALOBRENA-A

ceiling light; aluminium, white / plastic, white
Deckenleuchte; Alu, weiss / Kunststoff, weiss
plafonnier; aluminium, blanc / plastique, blanc

L 1200, B 300, H 50



31,5W 3900lm

98206 SALOBRENA-A

ceiling light; aluminium, white / plastic, white
Deckenleuchte; Alu, weiss / Kunststoff, weiss
plafonnier; aluminium, blanc / plastique, blanc

L 1195, B 100, H 50



30W 3900lm

98297 SALOBRENA-A

ceiling light; aluminium, white / plastic, white
Deckenleuchte; Alu, weiss / Kunststoff, weiss
plafonnier; aluminium, blanc / plastique, blanc

L 450, B 450, H 50



20W 2600lm



9 002759 982058



9 002759 982065



9 002759 982973

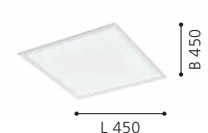



98297



98201



98203



98201 SALOBRENA-A

ceiling light; aluminium, white / plastic, white
Deckenleuchte; Alu, weiss / Kunststoff, weiss
plafonnier; aluminium, blanc / plastique, blanc

L 300, B 300, H 50



98203 SALOBRENA-A

ceiling light; aluminium, white / plastic, white
Deckenleuchte; Alu, weiss / Kunststoff, weiss
plafonnier; aluminium, blanc / plastique, blanc

L 600, B 600, H 50



9 002759 982010

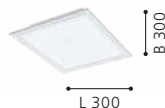

9 002759 982034

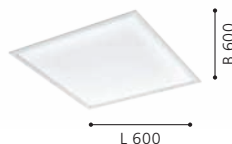



98292



incl./inkl./inclus



FUEVA-A

These luminaires inspire with their extremely flat and elegant design.

Diese Leuchten begeistern durch ihre extrem flache und elegante Bauweise.

Ces lumières enthousiasment par la méthode de construction extrêmement plate et élégante.



98293



incl./inkl./inclus



98292 FUEVA-A

surface-mounted light; aluminium, white / plastic, white
 Aufbauleuchte; Alu, weiss / Kunststoff, weiss
 luminaire en saillie; aluminium, blanc / plastique, blanc

H 30, Ø 225



14W



2000lm



Remote



98293 FUEVA-A

surface-mounted light; aluminium, white / plastic, white
 Aufbauleuchte; Alu, weiss / Kunststoff, weiss
 luminaire en saillie; aluminium, blanc / plastique, blanc

H 30, Ø 300



20W



2650lm



Remote



98212 FUEVA-A

recessed light; aluminium, white / plastic, white
 Einbauleuchte; Alu, weiss / Kunststoff, weiss
 luminaire encastrable; aluminium, blanc / plastique, blanc

Ø 120, ET 30



5W



700lm



Remote



Ø 108



9 002759 982928



9 002759 982935



9 002759 982126





98212

LED





LIGHTING FAMILIES / FABRIC LUMINAIRES

LEUCHTENFAMILIEN / STOFFLEUCHTEN
FAMILLES DE LUMINAIRES / LUMINAIRES À TEXTIL

EN **SIMPLE CLASSINESS**

The textile luminaires with their unusual designs are perfectly trendy and bring cosiness to every home. Selected textiles in natural shades and clear shapes form the basis of a friendly and tasteful living environment in our textile luminaires. Inner coatings in sophisticated gold and classical silver add an air of luxury.

DE **SCHLICHTE ELEGANZ**

Die Stoffleuchten mit ihrem außergewöhnlichen Design sind voll im Trend und sorgen für Gemütlichkeit in jedem Zuhause. Bei den Stoffleuchten bilden ausgesuchte Stoffe in Naturtönen und klaren Formgebungen die Grundlage für eine freundliche und geschmackvolle Wohnumgebung. Für einen Hauch von Luxus sorgen die Innenbeschichtungen in edlem Gold und klassischem Silber.

FR **ÉLÉGANCE SIMPLE**

Les luminaires en étoffe avec leur design extraordinaire sont très tendance et assurent un confort dans chaque maison. Chez les luminaires en étoffe, des étoffes sélectionnées dans des tons naturels et des formes claires forment la base d'un cadre de vie convivial et de bon goût. Les revêtements internes en or fin et en argent classique ajoutent une touche de luxe.





OVERVIEW

LIGHTING FAMILIES / FABRIC LUMINAIRS
LEUCHTENFAMILIEN / STOFFLEUCHTEN
FAMILLES DE LUMINAIRES / LUMINAIRES À TEXTIL

 ROMAO 1 136	 ROMAO 136-137	 ROMAO 3 136-137	 PASTERI 138-141,146-161	 PALOMARO 142-143	 PALOMARO 1 143	 PASTORE 144	 PASTORE 1 144
 PASTORE 2 145	 VISERBELLA 162-164	 ESTEPERRA 166-169	 VARILLAS 171	 MARASALES 172-174	 ZARAGOZA 176-177	 BUCAMARANGA 178	 MASERLO 180-181,184-193
 MASERLO 2 180, 186, 189, 192	 MASERLO 1 182-183	 CONCESSA 1 194-195	 ALBARIZA 196	 FENIGLIA 198-199	 ALMEIDA 2 200-201	 NASTASIA 202	 AGLIENTINA 203
 ALMEIDA 1 204	 ALMEIDA 205	 MARONDA 205					



This product is available in different colors and shapes. / Dieser Artikel ist in unterschiedlichen Farben und Formen verfügbar. / Cet article est disponible en différentes couleurs et formes.



Lighting Families / Wood luminaires starts on page 206.
Leuchtenfamilien / Holzleuchten starten auf Seite 206.
Familles d'éclairage / Luminaires à bois commence à la page 206.



Lighting Families / Essential luminaires starts on page 228.
Leuchtenfamilien / Standardleuchten starten auf Seite 228.
Familles d'éclairage / Luminaires standard commence à la page 228.



Lighting Families / Glass chandeliers starts on page 336.
Leuchtenfamilien / Glasluster starten auf Seite 336.
Familles d'éclairage / lustres en verre commence à la page 336.



FABRIC MATERIALS

STOFF MATERIALIEN
MATÉRIAUX EN TISSU

SHADES / SCHIRME / OMBRES

GLOSSY / GLÄNZEND / GLOSSY



fabric, glossy black
Textil, samtglänzend schwarz
tissu, velours noir brillant



fabric, glossy taupe
Textil, samtglänzend taupe
tissu, velours taupe brillant

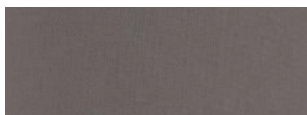

fabric, glossy cappucino
Textil, samtglänzend cappucino
tissu, velours cappucino brillant



fabric, glossy grey
Textil, samtglänzend grau
tissu, velours gris brillant



fabric, glossy white
Textil, samtglänzend weiß
tissu, velours blanc brillant



fabric, glossy gold
Textil, samtglänzend gold
tissu, velours or brillant

MAT / MATT / MAT



fabric, mat black
Textil, matt schwarz
tissu, tapis noir

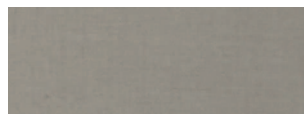

fabric, mat taupe
Textil, matt taupe
tissu, tapis taupe

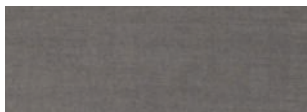

fabric, mat anthracite-brown
Textil, matt anthrazit-braun
tissu, tapis anthracite-marron

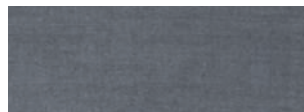

fabric, mat grey
Textil, matt grau
tissu, tapis gris



fabric, mat white
Textil, matt weiß
tissu, tapis blanc



fabric, mat white & gold
Textil, matt weiß & gold
tissu, tapis blanc & or

LINEN / LEINEN / LIN

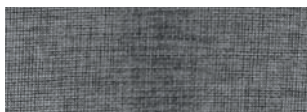

linen, grey
Leinen, grau
lin, gris



linen, brown
Leinen, braun
lin, marron

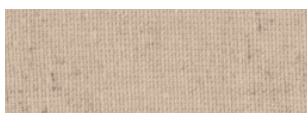

linen, natural
Leinen, natur
lin, nature

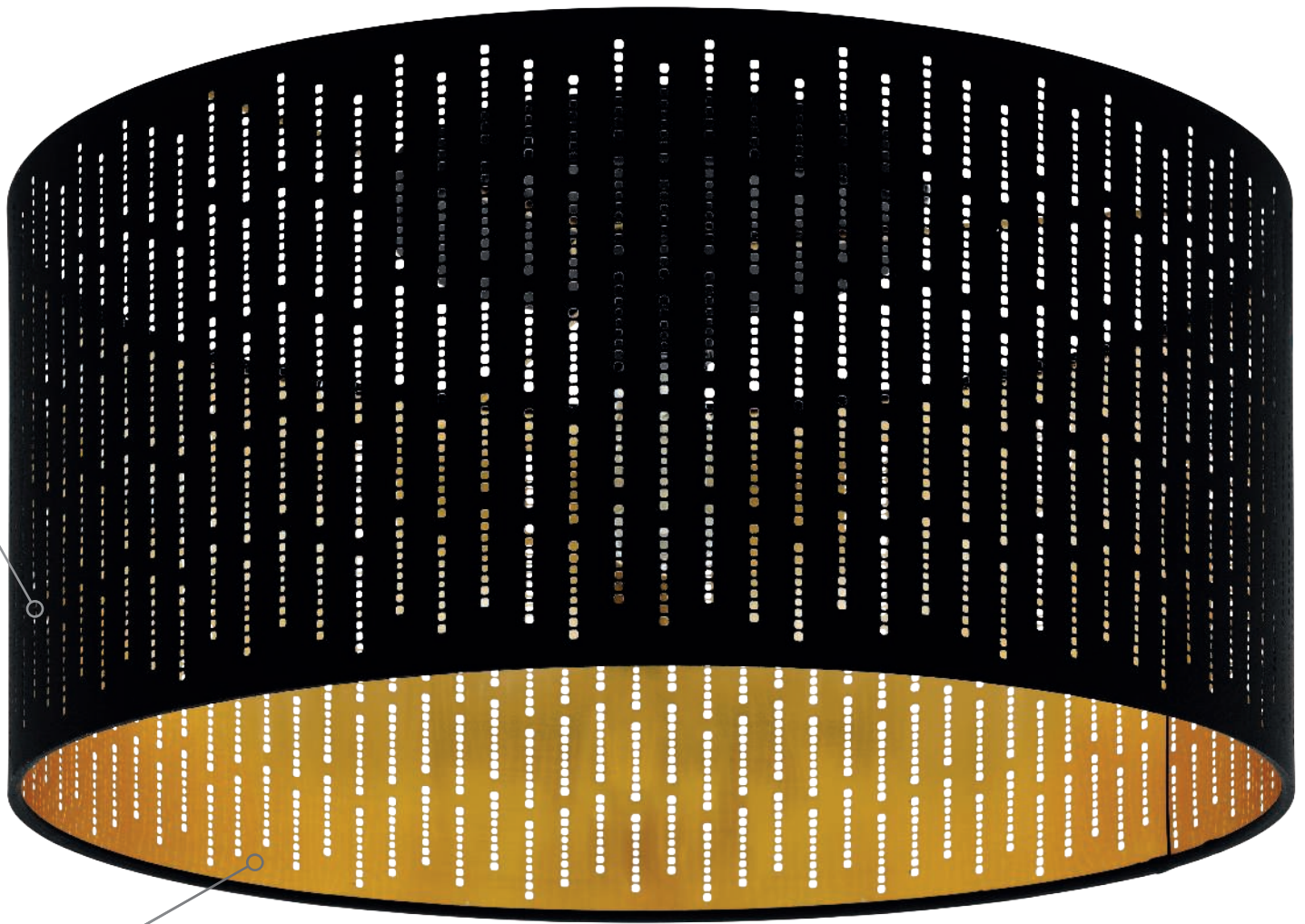

COATING / BESCHICHTUNG / REVÊTEMENT



coating, silver
Beschichtung, silber
revêtement, argent

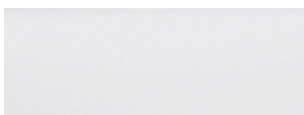

coating, white
Beschichtung, weiß
revêtement, blanc

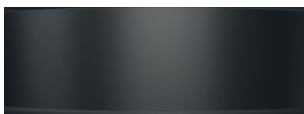

coating, black
Beschichtung, schwarz
revêtement, noir



coating, gold
Beschichtung, gold
revêtement, or



coating, copper
Beschichtung, kupfer
revêtement, coivre



coating, brass
Beschichtung, messing
revêtement, laiton



coating, brass & white
Beschichtung, messing & weiß
revêtement, laiton & blanc



97777



97778



97779



97777 ROMAO 1

ceiling light; steel, white / fabric, plastic, white
Deckenleuchte; Stahl, weiss / Textil, Kunststoff, weiss
plafonnier; acier, blanc / tissu, plastique, blanc

H 120, Ø 570



36W



4300lm



Remote

97779 ROMAO

ceiling light; steel, white / fabric linen, plastic, grey, white
Deckenleuchte; Stahl, weiss / Textil Leinen, Kunststoff, grau, weiss
plafonnier; acier, blanc / tissu de lin, plastique, gris, blanc

H 120, Ø 570



36W



4300lm



Remote

97778 ROMAO 3

ceiling light; steel, white / fabric, plastic, taupe, white
Deckenleuchte; Stahl, weiss / Textil, Kunststoff, taupe, weiss
plafonnier; acier, blanc / tissu, plastique, taupe, blanc

H 120, Ø 570



36W



4300lm



Remote



9 002759 977771

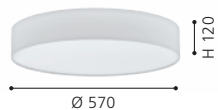

9 002759 977795

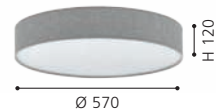

9 002759 977788

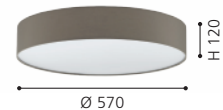



97783



97784



TUNABLE WHITE 3000 - 5000K	DIMMABLE 10 - 100%	TIMER FUNCTION off after 30sec.	NIGHT LIGHT FUNCTION	<u>97777</u>	<u>97783</u>
				<u>97778</u>	<u>97784</u>
				<u>97779</u>	

see page / siehe Seite / voir la page 478

97784 ROMAO

ceiling light; steel, white / fabric linen, plastic, grey, white
Deckenleuchte; Stahl, weiss / Textil Leinen, Kunststoff, grau, weiss
plafonnier; acier, blanc / tissu de lin, plastique, gris, blanc

H 120, Ø 760



97783 ROMAO 3

ceiling light; steel, white / fabric, plastic, taupe, white
Deckenleuchte; Stahl, weiss / Textil, Kunststoff, taupe, weiss
plafonnier; acier, blanc / tissu, plastique, taupe, blanc

H 120, Ø 760



9 002759 977849



9 002759 977832





97611 PASTERI

ceiling light; steel, white / fabric, white
Deckenleuchte; Stahl, weiss / Textil, weiss
plafonnier; acier, blanc / tissu, blanc

H 150, Ø 570



97615 PASTERI

ceiling light; steel, white / fabric, white
Deckenleuchte; Stahl, weiss / Textil, weiss
plafonnier; acier, blanc / tissu, blanc

H 150, Ø 760



97619 PASTERI

ceiling light; steel, white / fabric, white
Deckenleuchte; Stahl, weiss / Textil, weiss
plafonnier; acier, blanc / tissu, blanc

H 170, Ø 980





97613



97617



97613 PASTERI

ceiling light; steel, white / fabric, linen, grey, white
Deckenleuchte; Stahl, weiss / Textil, Leinen, grau, weiss
plafonnier; acier, blanc / tissu, lin, gris, blanc

H 150, Ø 570



E27 3x 25W

97617 PASTERI

ceiling light; steel, white / fabric, linen, grey, white
Deckenleuchte; Stahl, weiss / Textil, Leinen, grau, weiss
plafonnier; acier, blanc / tissu, lin, gris, blanc

H 150, Ø 760



E27 5x 25W



9 002759 976132



9 002759 976170





97614



97618



97614 PASTERI

ceiling light; steel, white / fabric, linen, brown, white
Deckenleuchte; Stahl, weiss / Textil, Leinen, braun, weiss
plafonnier; acier, blanc / tissu, lin, marron, blanc

H 150, Ø 570



9 002759 976149



97618 PASTERI

ceiling light; steel, white / fabric, linen, brown, white
Deckenleuchte; Stahl, weiss / Textil, Leinen, braun, weiss
plafonnier; acier, blanc / tissu, lin, marron, blanc

H 150, Ø 760



9 002759 976187





97612 PASTERI

ceiling light; steel, white / fabric, taupe, white
Deckenleuchte; Stahl, weiss / Textil, taupe, weiss
plafonnier; acier, blanc / tissu, taupe, blanc

H 150, Ø 570



97616 PASTERI

ceiling light; steel, white / fabric, taupe, white
Deckenleuchte; Stahl, weiss / Textil, taupe, weiss
plafonnier; acier, blanc / tissu, taupe, blanc

H 150, Ø 760



97621 PASTERI

ceiling light; steel, white / fabric, taupe, white
Deckenleuchte; Stahl, weiss / Textil, taupe, weiss
plafonnier; acier, blanc / tissu, taupe, blanc

H 170, Ø 980





93397

LED

93397 PALOMARO

ceiling light; plastic, white / fabric, anthracite
Deckenleuchte; Kunststoff, weiss / Textil, anthrazit
plafonnier; plastique, blanc / tissu, anthracite

H 110, Ø 500

LED

warm
WHITE



4x 5,4W 2200lm



9 002759 933975





99508



99509



PASTORE | PASTORE 1
PASTORE 2

99508 PASTORE 2

ceiling light; steel, white / fabric, black, white
Deckenleuchte; Stahl, weiss / Textil, schwarz, weiss
plafonnier; acier, blanc / tissu, noir, blanc

L 610, B 495, H 255



E27



3x 60W



9 002759 995089

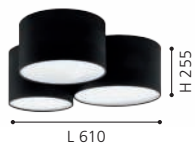

99509 PASTORE 2

ceiling light; steel, white / fabric, black, white
Deckenleuchte; Stahl, weiss / Textil, schwarz, weiss
plafonnier; acier, blanc / tissu, noir, blanc

H 285, Ø 990



E27



6x 40W



9 002759 995096

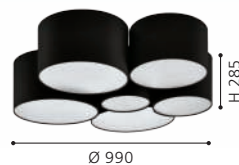

DESIGN
HIGHLIGHT
DETAIL



97479



97838



98409

97479 PASTORE

ceiling light; steel, white / fabric, anthracite-brown, white, grey
Deckenleuchte; Stahl, weiss / Textil, anthrazit-braun, weiss, grau
plafonnier; acier, blanc / tissu, marron anthracite, blanc, gri

L 610, B 495, H 255



E27 3x 60W

97838 PASTORE

ceiling light; steel, white / fabric, brown, grey, white, black
Deckenleuchte; Stahl, weiss / Textil, braun, grau, weiss, schwarz
plafonnier; acier, blanc / tissu, marron, gris, blanc, noir

H 285, Ø 990



E27 6x 40W

98409 PASTORE 1

ceiling light; steel, white / fabric, taupe
Deckenleuchte; Stahl, weiss / Textil, taupe
plafonnier; acier, blanc / tissu, taupe

H 250, Ø 990



E27 6x 40W



9 002759 974794

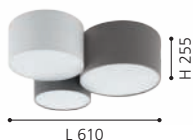

9 002759 978389

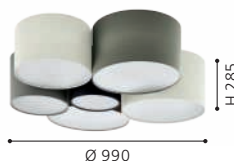

9 002759 984090





99508



99509



PASTORE | PASTORE 1
PASTORE 2

99508 PASTORE 2

ceiling light; steel, white / fabric, black, white
Deckenleuchte; Stahl, weiss / Textil, schwarz, weiss
plafonnier; acier, blanc / tissu, noir, blanc

L 610, B 495, H 255



E27 3x 60W



9 002759 995089

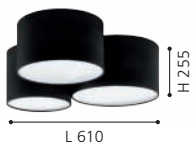

99509 PASTORE 2

ceiling light; steel, white / fabric, black, white
Deckenleuchte; Stahl, weiss / Textil, schwarz, weiss
plafonnier; acier, blanc / tissu, noir, blanc

H 285, Ø 990



E27 6x 40W



9 002759 995096

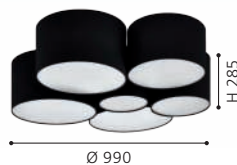



31581



31572

31581 PASTERI

pendant light; steel, satin nickel / fabric, taupe
 Hängeleuchte; Stahl, nickel-matt / Textil, taupe
 luminaire en suspension; acier, nickel mat / tissu, taupe

L 750, B 220, H 1100

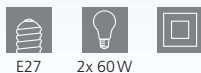

31572 PASTERI

pendant light; steel, satin nickel / fabric, taupe
 Hängeleuchte; Stahl, nickel-matt / Textil, taupe
 luminaire en suspension; acier, nickel mat / tissu, taupe

H 1100, Ø 380



31589 PASTERI

ceiling light; plastic, steel, white / fabric, taupe
 Deckenleuchte; Kunststoff, Stahl, weiss / Textil, taupe
 plafonnier; plastique, acier, blanc / tissu, taupe

H 90, Ø 320





31589

LED

31576 PASTERI

pendant light; steel, satin nickel / fabric, taupe
Hängeleuchte; Stahl, nickel-matt / Textil, taupe
luminaire en suspension; acier, nickel mat / tissu, taupe

H 1100, Ø 530



E27



1x 60W



9 002759 315764



31576



94919



94919



94925



96478

LED

94919 PASTERI

ceiling light; steel, satin nickel / fabric, glass, taupe
Deckenleuchte; Stahl, nickel-matt / Textil, Glas, taupe
plafonnier; acier, nickel mat / tissu, verre, taupe

H 195, Ø 475



94925 PASTERI

wall light; steel, satin nickel / fabric, taupe
Wandleuchte; Stahl, nickel-matt / Textil, taupe
Applique; acier, nickel mat / tissu, taupe

L 145, H 305, A 195

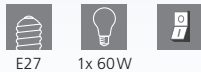

96478 PASTERI

wall light; steel, satin nickel / fabric, taupe
Wandleuchte; Stahl, nickel-matt / Textil, taupe
Applique; acier, nickel mat / tissu, taupe

L 150, H 380, A 195

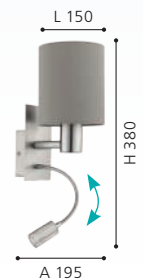



31595



95167

31595 PASTERI

table light; steel, satin nickel / fabric, taupe
Tischleuchte; Stahl, nickel-matt / Textil, taupe
luminaire de table; acier, nickel mat / tissu, taupe

H 400, Ø 180, Base: Ø 150



E27 1x 60W



9 002759 315955

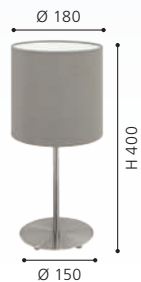

95167 PASTERI

floor light; steel, satin nickel / fabric, taupe
Stehleuchte; Stahl, nickel-matt / Textil, taupe
lampadaire; acier, nickel mat / tissu, taupe

H 1575, Ø 280, Base: Ø 230



E27 1x 60W



9 002759 951672





31592

LED



31582

31592 PASTERI

ceiling light; plastic, steel, white / fabric, grey
 Deckenleuchte; Kunststoff, Stahl, weiss / Textil, grau
 plafonnier; plastique, acier, blanc / tissu, gris

H 90, Ø 320

LED

warm
WHITE



3x 3,6W 1110lm



9 002759 315924



31582 PASTERI

pendant light; steel, satin nickel / fabric, grey
 Hängeleuchte; Stahl, nickel-matt / Textil, grau
 luminaire en suspension; acier, nickel mat / tissu, gris

L 750, B 220, H 1100



E27 2x 60W



9 002759 315825





94921



EGLO
RECOMMENDS
110033

94921



31573



31577

94921 PASTERI

ceiling light; steel, satin nickel / fabric, glass, grey
Deckenleuchte; Stahl, nickel-matt / Textil, Glas, grau
plafonnier; acier, nickel mat / tissu, verre, gris

H 195, Ø 475



E27 3x 25W



9 002759 949211

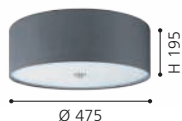

Ø 475

H 195

31577 PASTERI

pendant light; steel, satin nickel / fabric, grey
Hängeleuchte; Stahl, nickel-matt / Textil, grau
luminaire en suspension; acier, nickel mat / tissu, gris

H 1100, Ø 530



E27 1x 60W



9 002759 315771



Ø 530

H 1100

31573 PASTERI

pendant light; steel, satin nickel / fabric, grey
Hängeleuchte; Stahl, nickel-matt / Textil, grau
luminaire en suspension; acier, nickel mat / tissu, gris

H 1100, Ø 380



E27 1x 60W



9 002759 315733



Ø 380

H 1100



94926



96479

LED

94926 PASTERI

wall light; steel, satin nickel / fabric, grey
 Wandleuchte; Stahl, nickel-matt / Textil, grau
 Applique; acier, nickel mat / tissu, gris

L 145, H 305, A 195

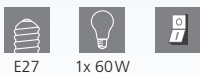

96479 PASTERI

wall light; steel, satin nickel / fabric, grey
 Wandleuchte; Stahl, nickel-matt / Textil, grau
 Applique; acier, nickel mat / tissu, gris

L 150, H 380, A 195

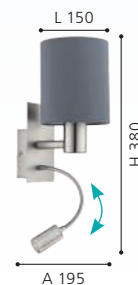



95119



95119

These luminaires can be switched on and off by touching the specially designed "Touch Me" part of the fixture.

Diese Leuchten können ein- und ausgeschaltet werden, indem man sie an den dafür vorgesehenen „Touch Me“ Bereichen berührt.

Ces luminaires peuvent être éteints et allumés simplement en touchant la partie spécialement conçue pour «Touch Me» du luminaire.



31596



95166

95119 PASTERI

table light; steel, satin nickel / fabric, grey
Tischleuchte; Stahl, nickel-matt / Textil, grau
luminaire de table; acier, nickel mat / tissu, gris

H 255, Ø 120



E27 1x 40W



9 002759 951191



31596 PASTERI

table light; steel, satin nickel / fabric, grey
Tischleuchte; Stahl, nickel-matt / Textil, grau
luminaire de table; acier, nickel mat / tissu, gris

H 400, Ø 180, Base: Ø 150

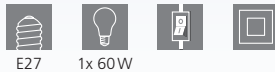

E27 1x 60W



9 002759 315962



95166 PASTERI

floor light; steel, satin nickel / fabric, grey
Stehleuchte; Stahl, nickel-matt / Textil, grau
lampadaire; acier, nickel mat / tissu, gris

H 1575, Ø 280, Base: Ø 230



E27 1x 60W



9 002759 951665





31574





31578



96481

The main and reading lights can be switched on separately.

Das Haupt- und das Leselicht können getrennt voneinander geschaltet werden.

Les luminaires principales et de lecture peuvent être allumées séparément.



96481

LED

31574 PASTERI

pendant light; steel, satin nickel / fabric, anthracite-brown
Hängeleuchte; Stahl, nickel-matt / Textil, anthrazit-braun
luminaire en suspension; acier, nickel mat / tissu, marron anthracite

H 1100, Ø 380



31578 PASTERI

pendant light; steel, satin nickel / fabric, anthracite-brown
Hängeleuchte; Stahl, nickel-matt / Textil, anthrazit-braun
luminaire en suspension; acier, nickel mat / tissu, marron anthracite

H 1100, Ø 530



96481 PASTERI

wall light; steel, satin nickel / fabric, anthracite-brown
Wandleuchte; Stahl, nickel-matt / Textil, anthrazit-braun
Applique; acier, nickel mat / tissu, marron anthracite

L 150, H 380, A 195

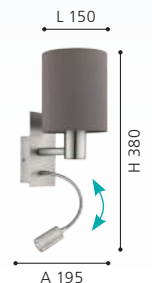



31571

31571 PASTERI

pendant light; steel, satin nickel / fabric, white
Hängeleuchte; Stahl, nickel-matt / Textil, weiss
luminaire en suspension; acier, nickel mat / tissu, blanc

H 1100, Ø 380



E27



1x 60W



9 002759 315719





31575 PASTERI

pendant light; steel, satin nickel / fabric, white
 Hängeleuchte; Stahl, nickel-matt / Textil, weiss
 luminaire en suspension; acier, nickel mat / tissu, blanc

H 1100, Ø 530



94918 PASTERI

ceiling light; steel, satin nickel / fabric, glass, white
 Deckenleuchte; Stahl, nickel-matt / Textil, Glas, weiss
 plafonnier; acier, nickel mat / tissu, verre, blanc

H 195, Ø 475

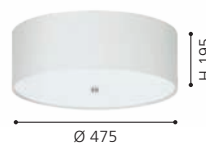

31588 PASTERI

ceiling light; plastic, steel, white / fabric, white
 Deckenleuchte; Kunststoff, Stahl, weiss / Textil, weiss
 plafonnier; plastique, acier, blanc / tissu, blanc

H 90, Ø 320

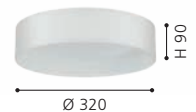



94924



96477

LED



95118

95118

These luminaires can be switched on and off by touching the specially designed "Touch Me" part of the fixture.

Diese Leuchten können ein- und ausgeschaltet werden, indem man sie an den dafür vorgesehenen „Touch Me“ Bereichen berührt.

Ces luminaires peuvent être éteints et allumés simplement en touchant la partie spécialement conçue pour «Touch Me» du luminaire.



96477 PASTERI

wall light; steel, satin nickel / fabric, white
Wandleuchte; Stahl, nickel-matt / Textil, weiss
Applique; acier, nickel mat / tissu, blanc

L 150, H 380, A 195

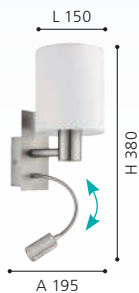

94924 PASTERI

wall light; steel, satin nickel / fabric, white
Wandleuchte; Stahl, nickel-matt / Textil, weiss
Applique; acier, nickel mat / tissu, blanc

L 145, H 305, A 195

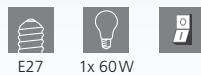

95118 PASTERI

table light; steel, satin nickel / fabric, white
Tischleuchte; Stahl, nickel-matt / Textil, weiss
luminaire de table; acier, nickel mat / tissu, blanc

H 255, Ø 120

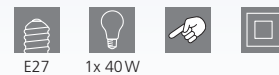



31594



95164

31594 PASTERI

table light; steel, satin nickel / fabric, white
Tischleuchte; Stahl, nickel-matt / Textil, weiss
luminaire de table; acier, nickel mat / tissu, blanc

H 400, Ø 180, Base: Ø 150

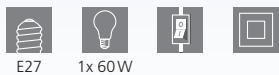

E27 1x 60W



9 002759 315948



95164 PASTERI

floor light; steel, satin nickel / fabric, white
Stehleuchte; Stahl, nickel-matt / Textil, weiss
lampadaire; acier, nickel mat / tissu, blanc

H 1575, Ø 280, Base: Ø 230



E27 1x 60W



9 002759 951641





95045 PASTERI

pendant light; steel, satin nickel / fabric, white, copper
 Hängeleuchte; Stahl, nickel-matt / Textil, weiss, kupfer
 luminaire en suspension; acier, nickel mat / tissu, blanc, cuivre

H 1100, Ø 530



96484 PASTERI

wall light; steel, satin nickel / fabric, white, copper
 Wandleuchte; Stahl, nickel-matt / Textil, weiss, kupfer
 Applique; acier, nickel mat / tissu, blanc, cuivre

L 150, H 380, A 195

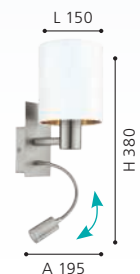



900701

LED



96483

LED

900701 PASTERI

wall light; steel, black / fabric, anthracite-brown
Wandleuchte; Stahl, schwarz / Textil, anthrazit-braun
Applique; acier, noir / tissu, marron anthracite

L 150, H 380, A 195



9 008606 251728

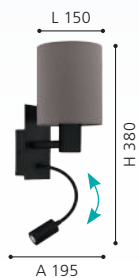

96483 PASTERI

wall light; steel, satin nickel / fabric, black, copper
Wandleuchte; Stahl, nickel-matt / Textil, schwarz, kupfer
Applique; acier, nickel mat / tissu, noir, cuivre

L 150, H 380, A 195



9 002759 964832

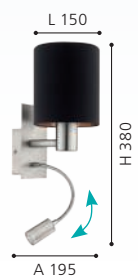

96483,
96484, 900701

The main and reading lights can be switched on separately.

Das Haupt- und das Leselicht können getrennt voneinander geschaltet werden.

Les luminaires principales et de lecture peuvent être allumées séparément.



97643



97644

97643 VISERBELLA

pendant light; steel, champagne / fabric, gold
 Hängeleuchte; Stahl, champagner / Textil, gold
 luminaire en suspension; acier, champagne / tissu, doré

H 1100, Ø 380

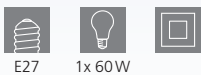

9 002759 976439



97644 VISERBELLA

pendant light; steel, champagne / fabric, gold
 Hängeleuchte; Stahl, champagner / Textil, gold
 luminaire en suspension; acier, champagne / tissu, doré

H 1100, Ø 530



9 002759 976446



97641 VISERBELLA

ceiling light; steel, champagne / fabric, gold
 Deckenleuchte; Stahl, champagner / Textil, gold
 plafonnier; acier, champagne / tissu, doré

H 110, Ø 380



9 002759 976415





97641



97642



97641 | 97642



97642 VISERBELLA

ceiling light; steel, champagne / fabric, gold
Deckenleuchte; Stahl, champagner / Textil, gold
plafonnier; acier, champagne / tissu, doré

H 195, Ø 470



9 002759 976422





DESIGN
HIGHLIGHT
DETAIL



97645



97647

97645 VISERBELLA

wall light; steel, champagne / fabric, gold
Wandleuchte; Stahl, champagner / Textil, gold
Applique; acier, champagne / tissu, doré

L 145, H 305, A 195



E27

1x 60W



9 002759 976453



97647 VISERBELLA

floor light; steel, champagne / fabric, gold
Stehleuchte; Stahl, champagner / Textil, gold
lampadaire; acier, champagne / tissu, doré

H 1585, Ø 280, Base: Ø 230



E27

1x 60W



9 002759 976477



97646 VISERBELLA

table light; steel, champagne / fabric, gold
Tischleuchte; Stahl, champagner / Textil, gold
luminaire de table; acier, champagne / tissu, doré

H 400, Ø 180, Base: Ø 150



E27

1x 60W



9 002759 976460

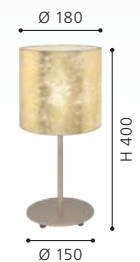



97646



DESIGN
HIGHLIGHT
DETAIL



99273 ESTEPERRA

pendant light; steel, black / fabric, black, gold
Hängeleuchte; Stahl, schwarz / Textil, schwarz, gold
luminaire en suspension; acier, noir / tissu, noir, or

H 1100, Ø 380

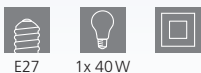

99272 ESTEPERRA

ceiling light; steel, black / fabric, black, gold
Deckenleuchte; Stahl, schwarz / Textil, schwarz, gold
plafonnier; acier, noir / tissu, noir, or

H 240, Ø 475

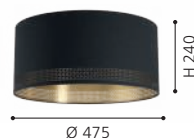

99274 ESTEPERRA

pendant light; steel, black / fabric, black, gold
Hängeleuchte; Stahl, schwarz / Textil, schwarz, gold
luminaire en suspension; acier, noir / tissu, noir, or

H 1100, Ø 530





99274



99279

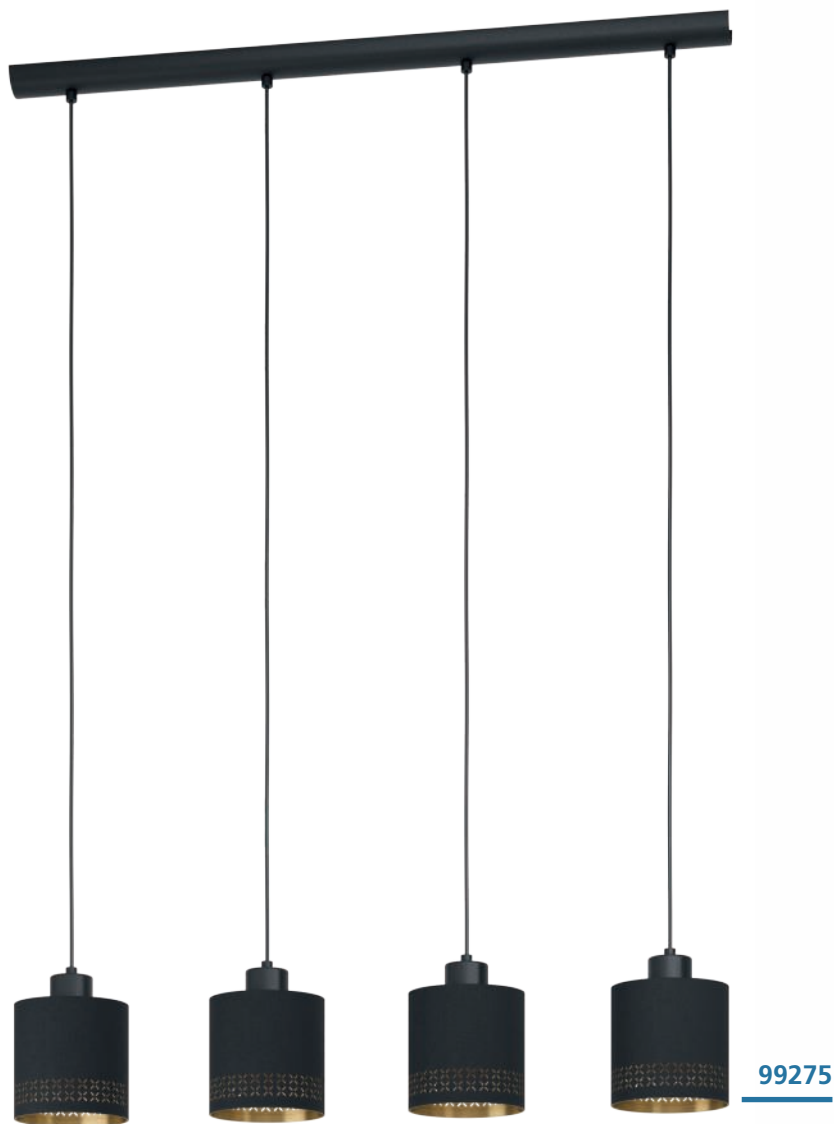

99275

DESIGN
HIGHLIGHT
DETAIL



99279 ESTEPERRA

floor light; steel, black / fabric, black, gold
Stehleuchte; Stahl, schwarz / Textil, schwarz, gold
lampadaire; acier, noir / tissu, noir, or

H 1405, Ø 380, Base: Ø 645

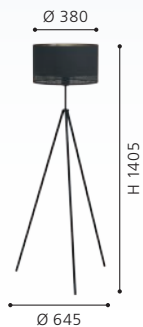
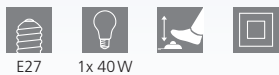

99275 ESTEPERRA

pendant light; steel, black / fabric, black, gold
Hängeleuchte; Stahl, schwarz / Textil, schwarz, gold
luminaire en suspension; acier, noir / tissu, noir, or

L 940, B 160, H 1100





98313

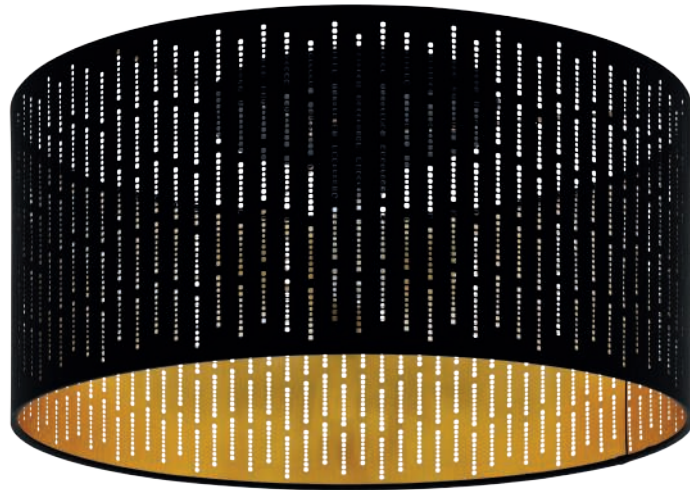

98311



98314

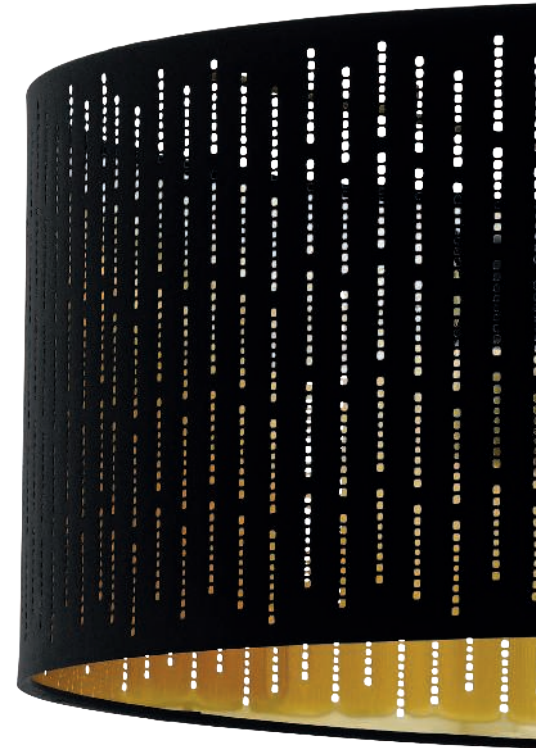

98313 VARILLAS

pendant light; steel, black / fabric with cut-outs, black, gold
Hängeleuchte; Stahl, schwarz / Textil mit Ausstanzungen, schwarz, gold

luminaire en suspension; acier, noir / tissu avec découpes, noir, or

H 1100, Ø 530



E27 3x 40W



9 002759 983130



98311 VARILLAS

ceiling light; steel, black / fabric with cut-outs, black, gold
Deckenleuchte; Stahl, schwarz / Textil mit Ausstanzungen, schwarz, gold

plafonnier; acier, noir / tissu avec découpes, noir, or

H 240, Ø 475



E27 1x 40W



9 002759 983116

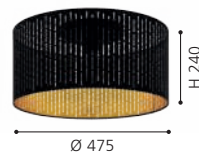

98314 VARILLAS

table light; steel, black / fabric with cut-outs, black, gold
Tischleuchte; Stahl, schwarz / Textil mit Ausstanzungen, schwarz, gold

luminaire de table; acier, noir / tissu avec découpes, noir, or

H 255, Ø 120

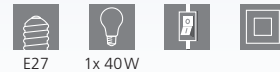

E27 1x 40W



9 002759 983147

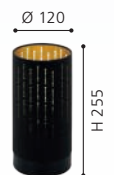



99613

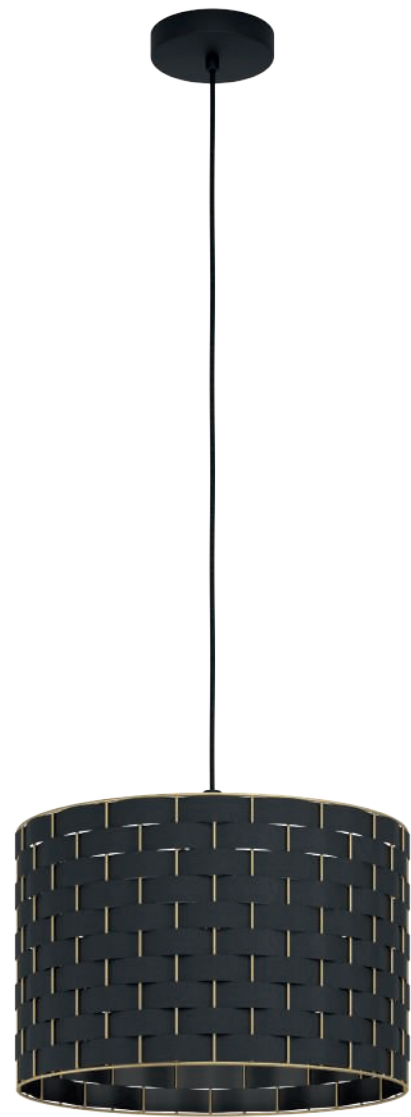

99524

99613 MARASALES

pendant light; steel, black / fabric, black, brass
 Hängeleuchte; Stahl, schwarz / Textil, schwarz, messing
 luminaire en suspension; acier, noir / tissu, noir, laiton

L 780, B 220, H 1100

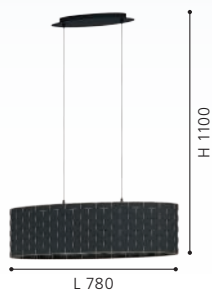
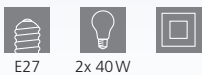

99524 MARASALES

pendant light; steel, black / fabric, black, brass
 Hängeleuchte; Stahl, schwarz / Textil, schwarz, messing
 luminaire en suspension; acier, noir / tissu, noir, laiton

H 1100, Ø 380



99525 MARASALES

pendant light; steel, black / fabric, black, brass
 Hängeleuchte; Stahl, schwarz / Textil, schwarz, messing
 luminaire en suspension; acier, noir / tissu, noir, laiton

H 1100, Ø 550



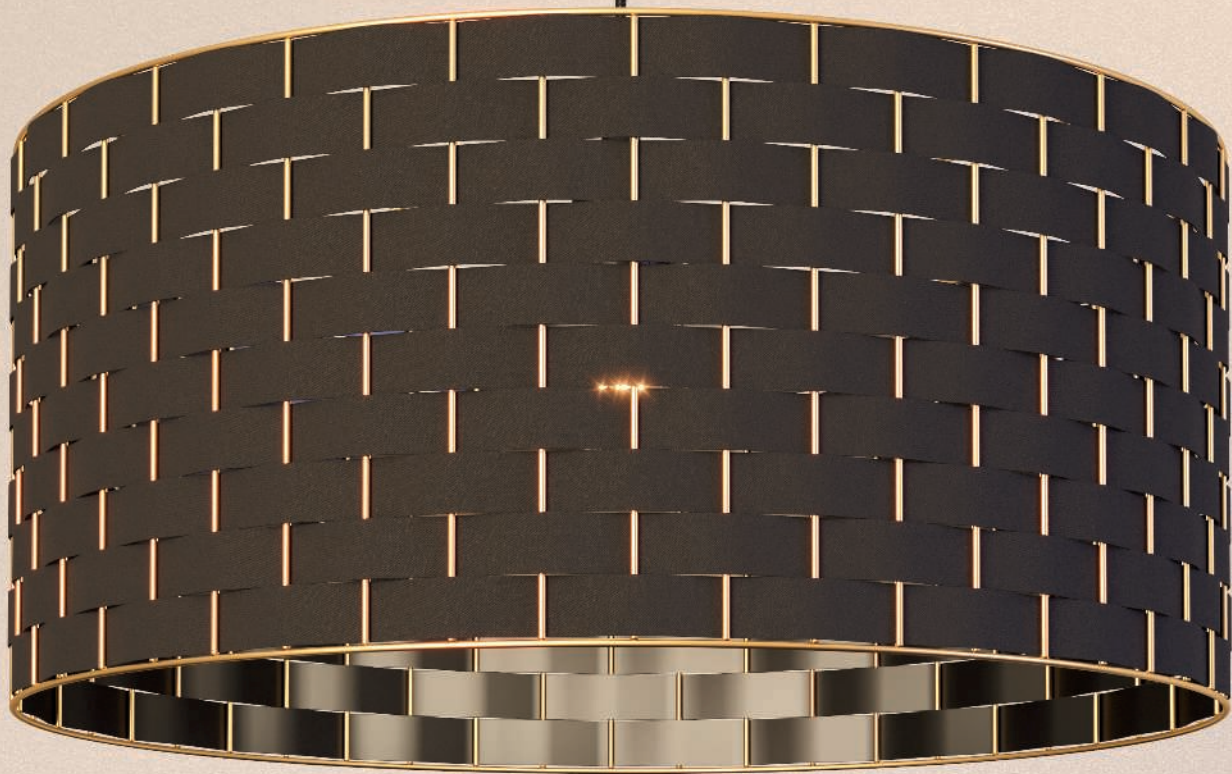

99525





99523

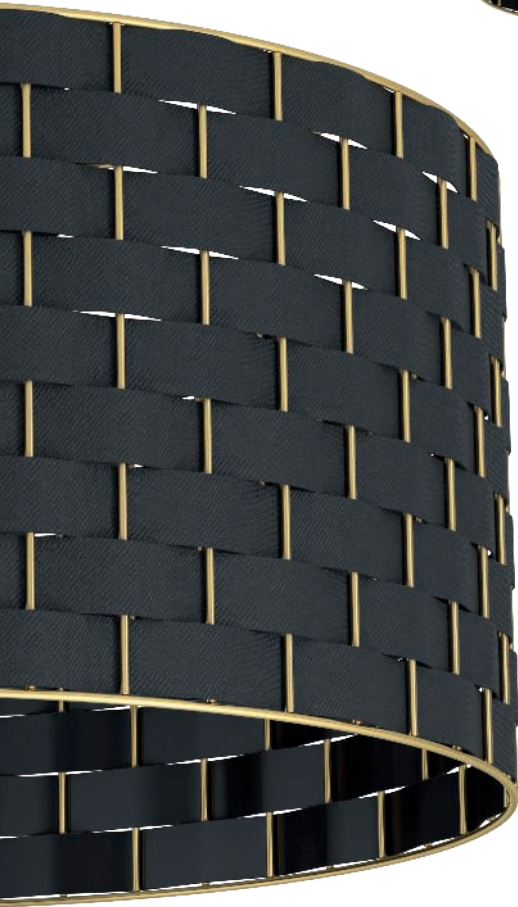

99526

99523 MARASALES

ceiling light; steel, black / fabric, black, brass
Deckenleuchte; Stahl, schwarz / Textil, schwarz, messing
plafonnier; acier, noir / tissu, noir, laiton

H 250, Ø 480



E27

1x 40W



9 002759 995232

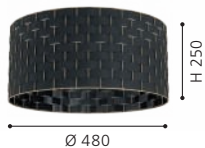

99526 MARASALES

table light; steel, black / fabric, black, brass
Tischleuchte; Stahl, schwarz / Textil, schwarz, messing
luminaire de table; acier, noir / tissu, noir, laiton

H 570, Ø 280



E27

1x 40W



9 002759 995263



99527 MARASALES

floor light; steel, black / fabric, black, brass
Stehleuchte; Stahl, schwarz / Textil, schwarz, messing
lampadaire; acier, noir / tissu, noir, laiton

H 1490, Ø 450, Base: Ø 745



E27

1x 40W



9 002759 995270





99527



900145



900144

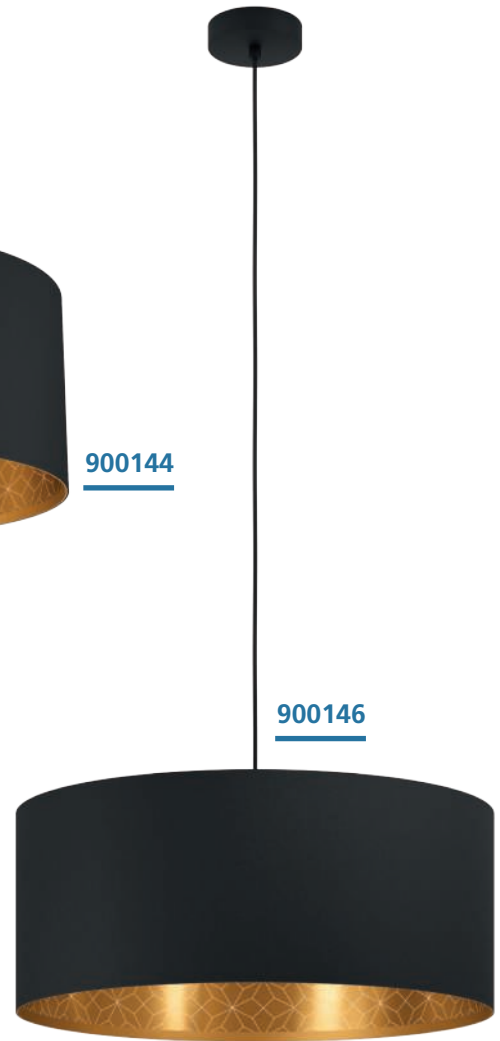

900146

900145 ZARAGOZA

pendant light; steel, black / fabric with decoration, black, gold
Hängeleuchte; Stahl, schwarz / Textil mit Dekor, schwarz, gold
luminaire en suspension; acier, noir / tissu avec décor, noir, or

H 1100, Ø 380



E27



1x 40W



9 008606 235384



900144 ZARAGOZA

ceiling light; steel, black / fabric with decoration, black, gold
Deckenleuchte; Stahl, schwarz / Textil mit Dekor, schwarz, gold
plafonnier; acier, noir / tissu avec décor, noir, or

H 240, Ø 475



E27



1x 40W



9 008606 235377

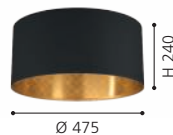

900146 ZARAGOZA

pendant light; steel, black / fabric with decoration, black, gold
Hängeleuchte; Stahl, schwarz / Textil mit Dekor, schwarz, gold
luminaire en suspension; acier, noir / tissu avec décor, noir, or

H 1100, Ø 530



E27



1x 40W



9 008606 235391

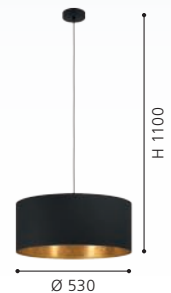

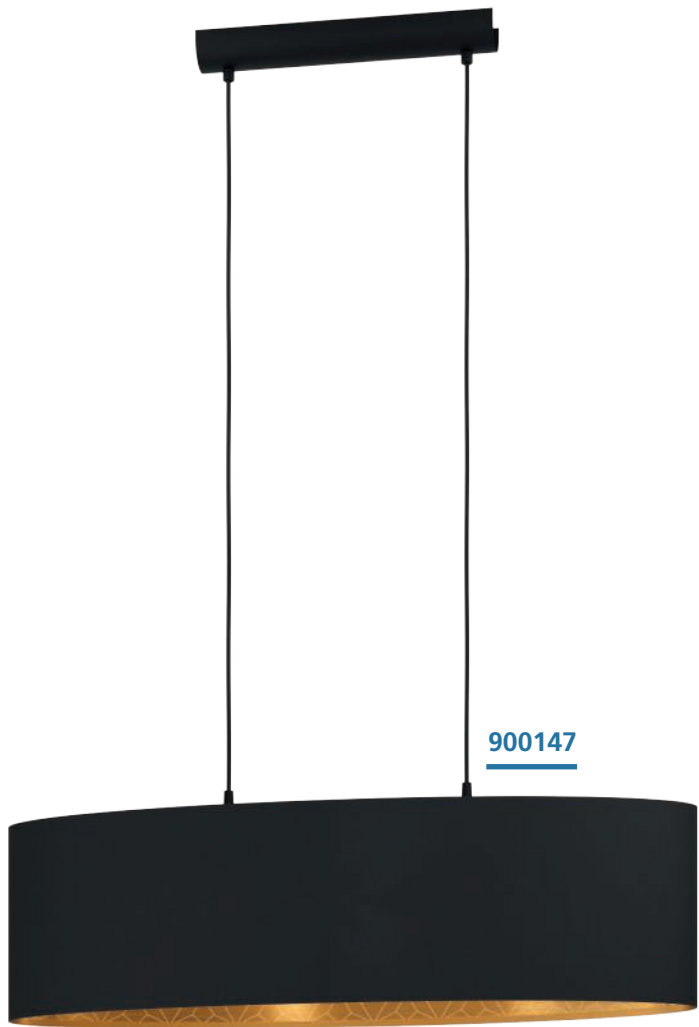

900147

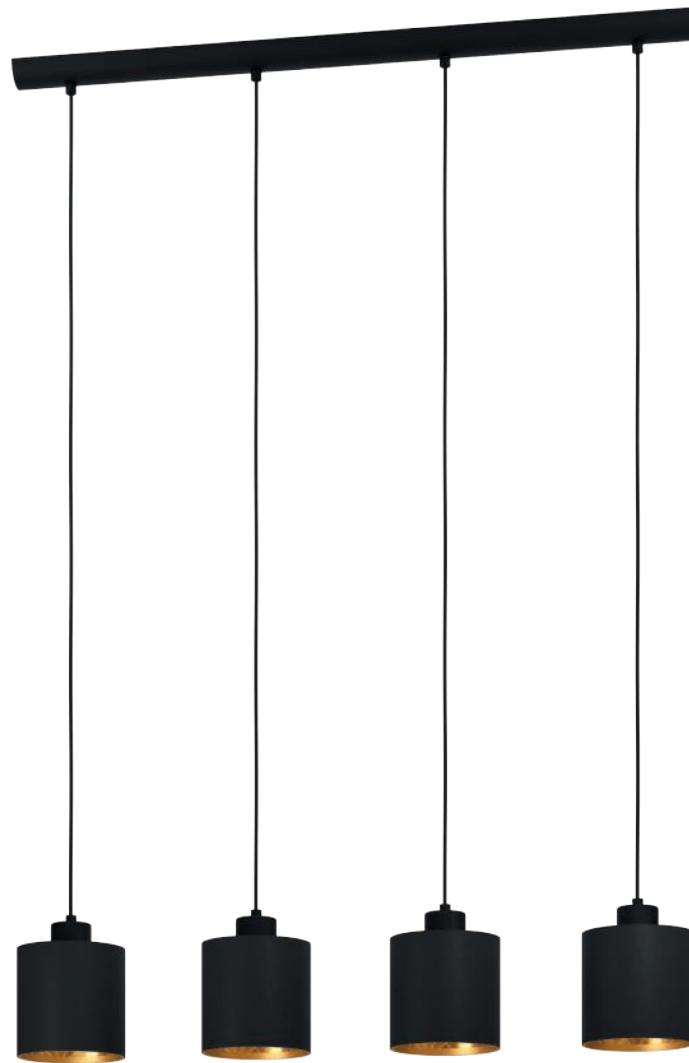

900148

900147 ZARAGOZA

pendant light; steel, black / fabric with decoration, black, gold
 Hängeleuchte; Stahl, schwarz / Textil mit Dekor, schwarz, gold
 luminaire en suspension; acier, noir / tissu avec décor, noir, or

L 780, B 220, H 1100



E27



2x 40W



9 008606 235407

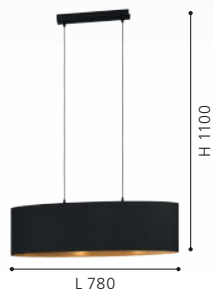

900148 ZARAGOZA

pendant light; steel, black / fabric with decoration, black, gold
 Hängeleuchte; Stahl, schwarz / Textil mit Dekor, schwarz, gold
 luminaire en suspension; acier, noir / tissu avec décor, noir, or

L 925, B 160, H 1100



E27



4x 28W



9 008606 235414

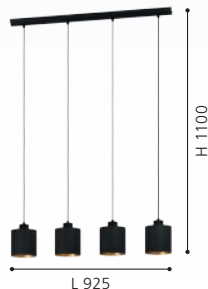



DESIGN
HIGHLIGHT
DETAIL



900634

900634 BUCAMARANGA

ceiling light; steel, white / fabric with decoration, white, gold
Deckenleuchte; Stahl, weiss / Textil mit Dekor, weiss, gold
plafonnier; acier, blanc / tissu avec décor, blanc, or

H 240, Ø 475



9 008606 241200



900635 BUCAMARANGA

pendant light; steel, white / fabric with decoration, white, gold
Hängeleuchte; Stahl, weiss / Textil mit Dekor, weiss, gold
luminaire en suspension; acier, blanc / tissu avec décor, blanc, or

H 1100, Ø 530



9 008606 241217





900635





31601



99543

LED



31606

31601 MASERLO

pendant light; steel, satin nickel / fabric, grey, silver
 Hängeleuchte; Stahl, nickel-matt / Textil, grau, silber
 luminaire en suspension; acier, nickel mat / tissu, gris, argent

H 1100, Ø 380

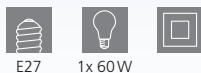

9 002759 316013



31606 MASERLO

pendant light; steel, satin nickel / fabric, grey, silver
 Hängeleuchte; Stahl, nickel-matt / Textil, grau, silber
 luminaire en suspension; acier, nickel mat / tissu, gris, argent

H 1100, Ø 530



9 002759 316068



99543 MASERLO 2

ceiling light; plastic, steel, white / fabric, grey, silver
 Deckenleuchte; Kunststoff, Stahl, weiss / Textil, grau, silber
 plafonnier; plastique, acier, blanc / tissu, gris, argent

H 90, Ø 380



9 002759 995430



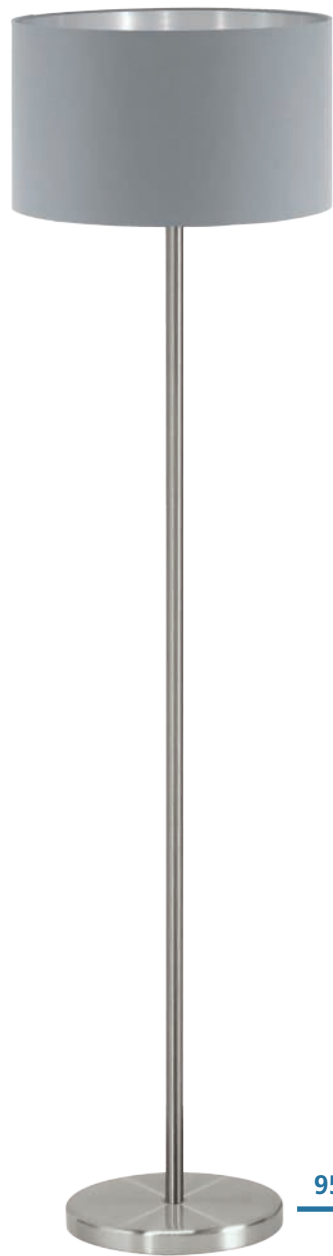

95173



95173 MASERLO

floor light; steel, satin nickel / fabric, grey, silver
Stehleuchte; Stahl, nickel-matt / Textil, grau, silber
lampadaire; acier, nickel mat / tissu, gris, argent

H 1510, Ø 380, Base: Ø 250



E27



1x 60W



Ø 380

H 1510

Ø 250



9 002759 951733



99042



99043

99042 MASERLO 1

pendant light; steel, black / fabric, black
 Hängeleuchte; Stahl, schwarz / Textil, schwarz
 luminaire en suspension; acier, noir / tissu, noir

H 1100, Ø 380



9 002759 990428



99043 MASERLO 1

pendant light; steel, black / fabric, black
 Hängeleuchte; Stahl, schwarz / Textil, schwarz
 luminaire en suspension; acier, noir / tissu, noir

H 1100, Ø 530

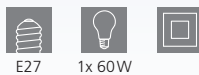

9 002759 990435



99045 MASERLO 1

table light; steel, black / fabric, black
 Tischleuchte; Stahl, schwarz / Textil, schwarz
 luminaire de table; acier, noir / tissu, noir

H 415, Ø 230, Base: Ø 145



9 002759 990459





MASERLO 1



99045

99046 MASERLO 1

floor light; steel, black / fabric, black
Stehleuchte; Stahl, schwarz / Textil, schwarz
lampadaire; acier, noir / tissu, noir

H 1515, Ø 380, Base: Ø 250



E27



1x 40W



9 002759 990466

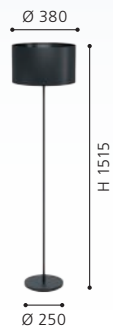

99046



31611



31616



31611 MASERLO

pendant light; steel, satin nickel / fabric, black, gold
Hängeleuchte; Stahl, nickel-matt / Textil, schwarz, gold
luminaire en suspension; acier, nickel mat / tissu, noir, or

L 780, B 220, H 1100

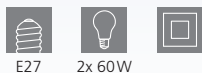

E27 2x 60W

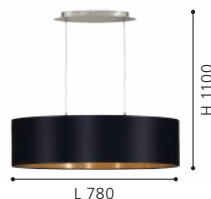

31616 MASERLO

pendant light; steel, satin nickel / fabric, black, gold
Hängeleuchte; Stahl, nickel-matt / Textil, schwarz, gold
luminaire en suspension; acier, nickel mat / tissu, noir, or

L 1000, B 250, H 1100

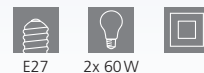

E27 2x 60W

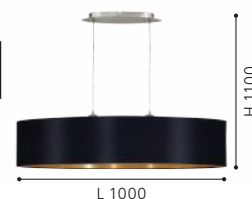



31599



31605

31599 MASERLO

pendant light; steel, satin nickel / fabric, black, gold
 Hängeleuchte; Stahl, nickel-matt / Textil, schwarz, gold
 luminaire en suspension; acier, nickel mat / tissu, noir, or

H 1100, Ø 380



E27 1x 60W



9 002759 315993

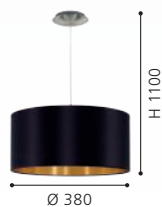

31605 MASERLO

pendant light; steel, satin nickel / fabric, black, gold
 Hängeleuchte; Stahl, nickel-matt / Textil, schwarz, gold
 luminaire en suspension; acier, nickel mat / tissu, noir, or

H 1100, Ø 530



E27 3x 60W



9 002759 316051





99539

LED



31627

99539 MASERLO 2

ceiling light; plastic, steel, white / fabric, black, gold
Deckenleuchte; Kunststoff, Stahl, weiss / Textil, schwarz, gold
plafonnier; plastique, acier, blanc / tissu, noir, or

H 90, Ø 380

LED

warm
WHITE



20W

2400lm



9 002759 995393

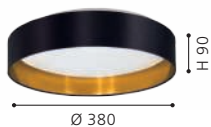

31627 MASERLO

table light; steel, satin nickel / fabric, black, gold
Tischleuchte; Stahl, nickel-matt / Textil, schwarz, gold
luminaire de table; acier, nickel mat / tissu, noir, or

H 420, Ø 230, Base: Ø 145



E27

1x 60W



9 002759 316273



95169 MASERLO

floor light; steel, satin nickel / fabric, black, gold
Stehleuchte; Stahl, nickel-matt / Textil, schwarz, gold
lampadaire; acier, nickel mat / tissu, noir, or

H 1510, Ø 380, Base: Ø 250



E27

1x 60W



9 002759 951696

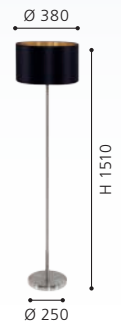



95169



31618

31613

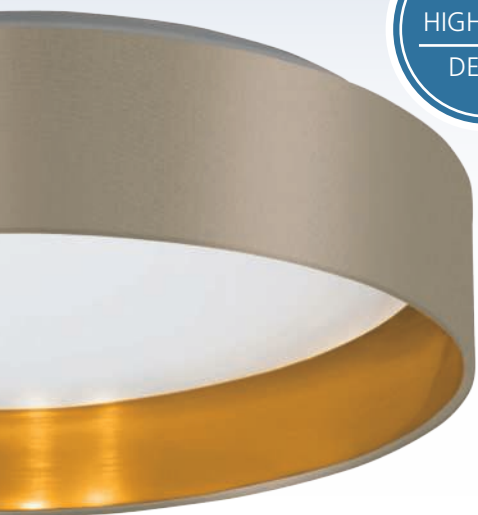

31618 MASERLO

pendant light; steel, satin nickel / fabric, taupe, gold
 Hängeleuchte; Stahl, nickel-matt / Textil, taupe, gold
 luminaire en suspension; acier, nickel mat / tissu, taupe, or

L 1000, B 250, H 1100

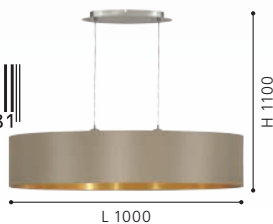

31613 MASERLO

pendant light; steel, satin nickel / fabric, taupe, gold
 Hängeleuchte; Stahl, nickel-matt / Textil, taupe, gold
 luminaire en suspension; acier, nickel mat / tissu, taupe, or

L 780, B 220, H 1100

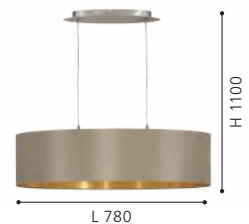
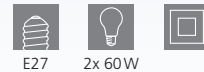



31602



99541

LED



31607

31602 MASERLO

pendant light; steel, satin nickel / fabric, taupe, gold
 Hängeleuchte; Stahl, nickel-matt / Textil, taupe, gold
 luminaire en suspension; acier, nickel mat / tissu, taupe, or

H 1100, Ø 380

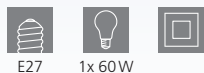

E27 1x 60W



9 002759 316020



99541 MASERLO 2

ceiling light; plastic, steel, white / fabric, taupe, gold
 Deckenleuchte; Kunststoff, Stahl, weiss / Textil, taupe, gold
 plafonnier; plastique, acier, blanc / tissu, taupe, or

H 90, Ø 380



LED 20W 2400lm



9 002759 995416

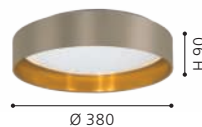

31607 MASERLO

pendant light; steel, satin nickel / fabric, taupe, gold
 Hängeleuchte; Stahl, nickel-matt / Textil, taupe, gold
 luminaire en suspension; acier, nickel mat / tissu, taupe, or

H 1100, Ø 530



E27 3x 60W



9 002759 316075

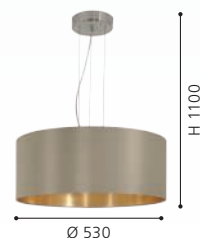



95055

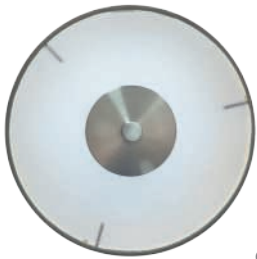

95055

The diffuser on the top ensures harmonious light distribution.

Der Diffusor auf der Oberseite sorgt für eine harmonische Lichtverteilung.

Le diffuseur situé sur le dessus assure une répartition harmonieuse de la lumière.



31629

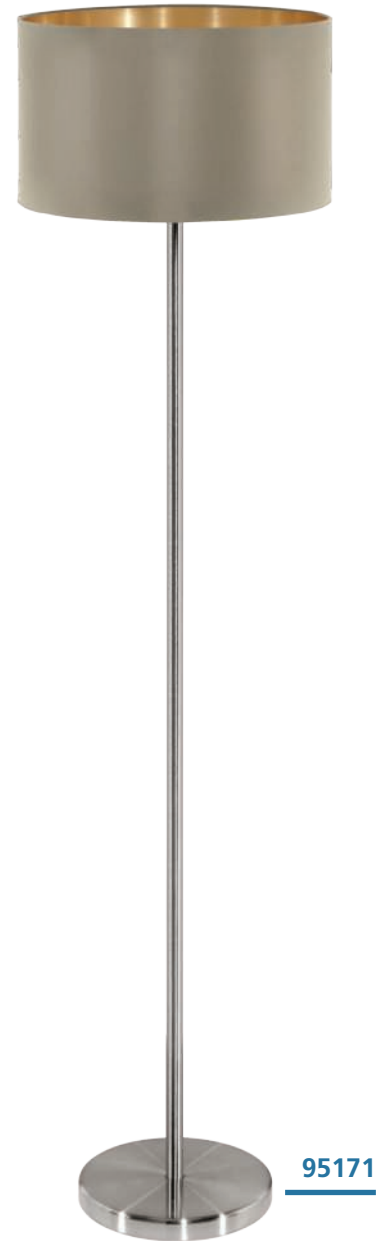

95171

95055 MASERLO

wall light; steel, satin nickel / fabric, taupe, gold
Wandleuchte; Stahl, nickel-matt / Textil, taupe, gold
Applique; acier, nickel mat / tissu, taupe, or

H 260, Ø 230, A 595



E27

1x 60W



9 002759 950552

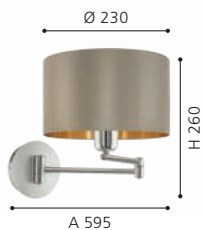

31629 MASERLO

table light; steel, satin nickel / fabric, taupe, gold
Tischleuchte; Stahl, nickel-matt / Textil, taupe, gold
luminaire de table; acier, nickel mat / tissu, taupe, or

H 420, Ø 230, Base: Ø 145



E27

1x 60W



9 002759 316297



95171 MASERLO

floor light; steel, satin nickel / fabric, taupe, gold
Stehleuchte; Stahl, nickel-matt / Textil, taupe, gold
lampadaire; acier, nickel mat / tissu, taupe, or

H 1510, Ø 380, Base: Ø 250



E27

1x 60W



9 002759 951719

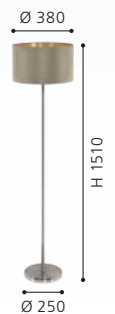



31614



31603

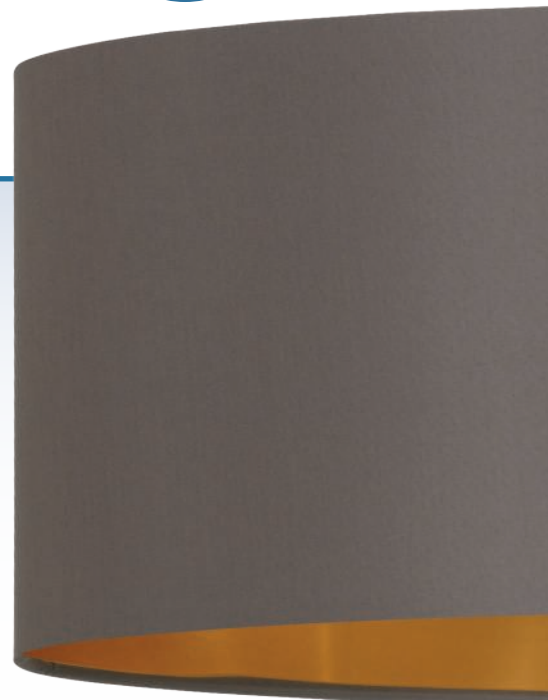

31614 MASERLO

pendant light; steel, satin nickel / fabric, cappuccino, gold
 Hängeleuchte; Stahl, nickel-matt / Textil, cappuccino, gold
 luminaire en suspension; acier, nickel mat / tissu, cappucino, or

L 780, B 220, H 1100

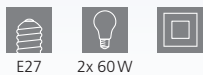

E27 2x 60W



31603 MASERLO

pendant light; steel, satin nickel / fabric, cappuccino, gold
 Hängeleuchte; Stahl, nickel-matt / Textil, cappuccino, gold
 luminaire en suspension; acier, nickel mat / tissu, cappucino, or

H 1100, Ø 380

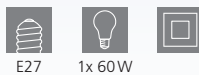

E27 1x 60W





99542

LED

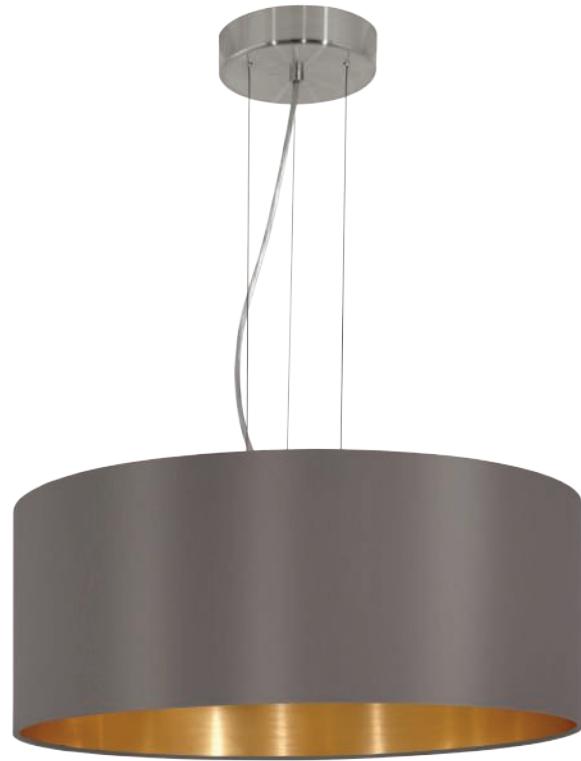
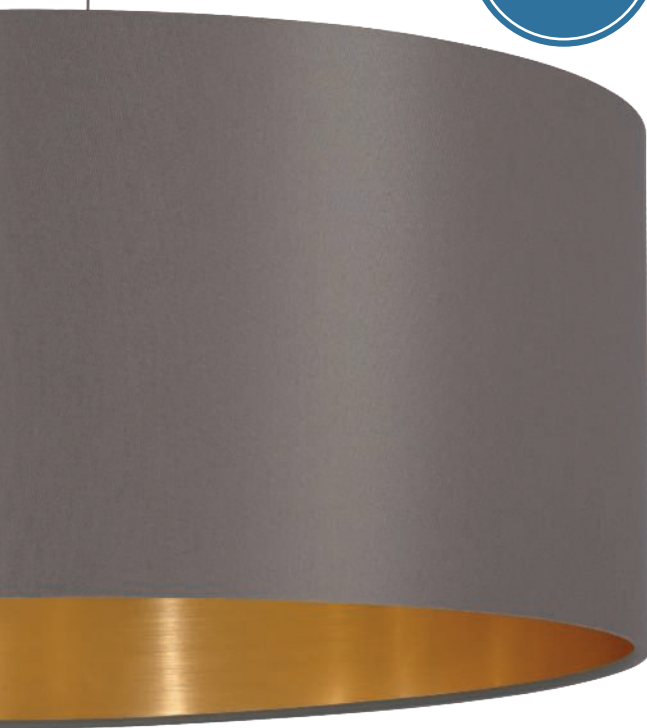

31608

99542 MASERLO 2

ceiling light; plastic, steel, white / fabric, cappuccino, gold
Deckenleuchte; Kunststoff, Stahl, weiss / Textil, cappuccino, gold
plafonnier; plastique, acier, blanc / tissu, cappuccino, or

H 90, Ø 380

LED

warm
WHITE
20W 2400lm



9 002759 995423

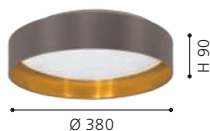

31608 MASERLO

pendant light; steel, satin nickel / fabric, cappuccino, gold
Hängeleuchte; Stahl, nickel-matt / Textil, cappuccino, gold
luminaire en suspension; acier, nickel mat / tissu, cappuccino, or

H 1100, Ø 530



E27



3x 60W



9 002759 316082



31631 MASERLO

table light; steel, satin nickel / fabric, cappuccino, gold
Tischleuchte; Stahl, nickel-matt / Textil, cappuccino, gold
luminaire de table; acier, nickel mat / tissu, cappuccino, or

H 420, Ø 230, Base: Ø 145



E27



1x 60W



9 002759 316310





31631

95172 MASERLO

floor light; steel, satin nickel / fabric, cappuccino, gold
Stehleuchte; Stahl, nickel-matt / Textil, cappuccino, gold
lampadaire; acier, nickel mat / tissu, cappuccino, or

H 1510, Ø 380, Base: Ø 250



E27



1x 60W



9 002759 951726

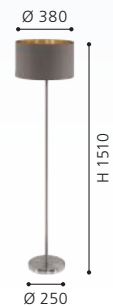

95172

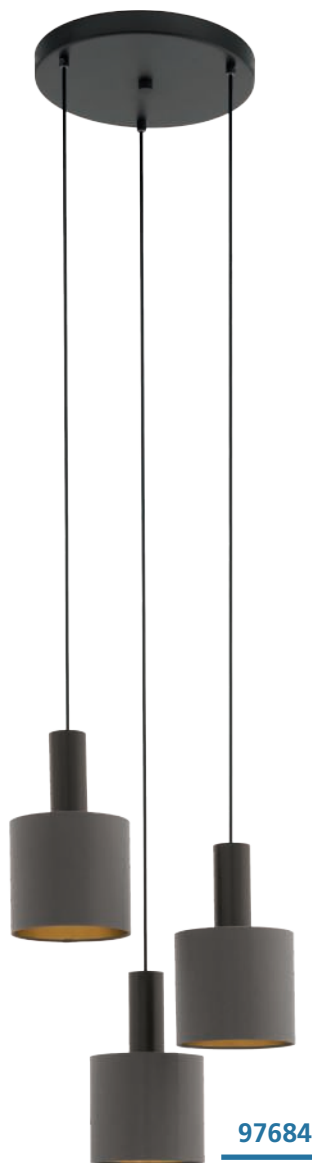

97684

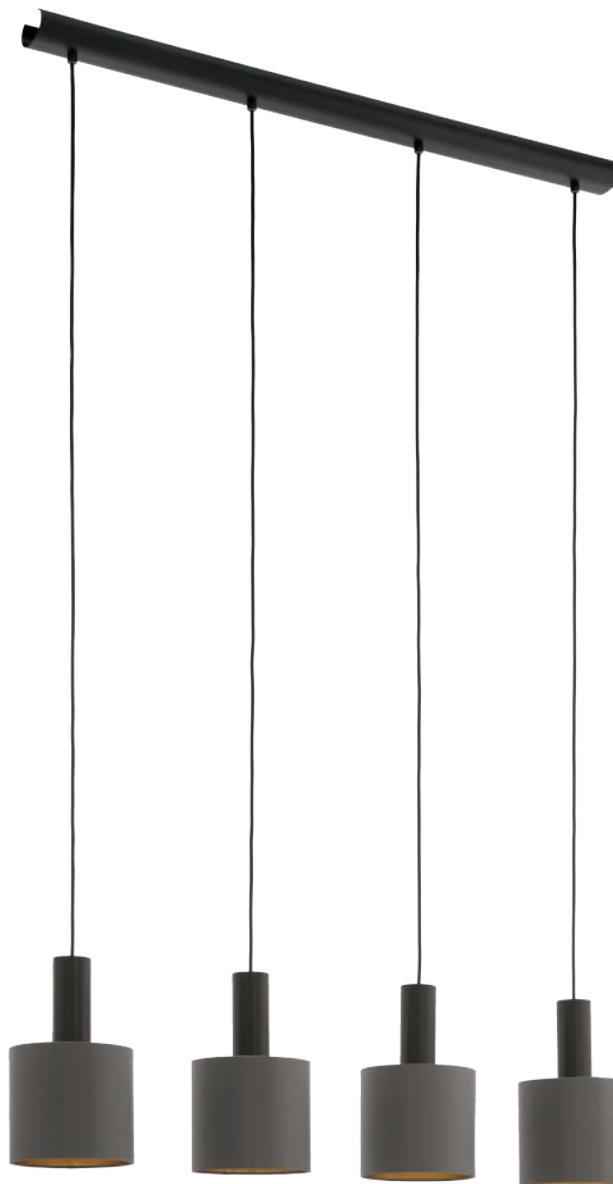

97685

97684 CONCESSA 1

pendant light; steel, dark brown / fabric, cappuccino, gold
 Hängeleuchte; Stahl, dunkelbraun / Textil, cappuccino, gold
 luminaire en suspension; acier, marron foncé / tissu, cappuccino, or

H 1500, Ø 420



E27



3x 60W



9 002759 976842



97685 CONCESSA 1

pendant light; steel, dark brown / fabric, cappuccino, gold
 Hängeleuchte; Stahl, dunkelbraun / Textil, cappuccino, gold
 luminaire en suspension; acier, marron foncé / tissu, cappuccino, or

L 940, B 160, H 1500



E27



4x 60W



9 002759 976859

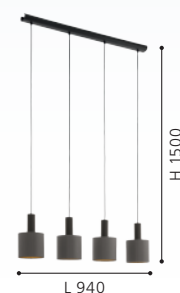



97683



97682

97683 CONCESSA 1

pendant light; steel, dark brown / fabric, cappuccino, gold
 Hängeleuchte; Stahl, dunkelbraun / Textil, cappuccino, gold
 luminaire en suspension; acier, marron foncé / tissu, cappuccino, or

H 1500, Ø 530

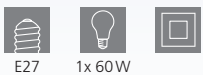

97682 CONCESSA 1

pendant light; steel, dark brown / fabric, cappuccino, gold
 Hängeleuchte; Stahl, dunkelbraun / Textil, cappuccino, gold
 luminaire en suspension; acier, marron foncé / tissu, cappuccino, or

H 1500, Ø 380

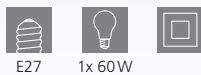

DESIGN
HIGHLIGHT
DETAIL



99445



99446



99445 ALBARIZA

pendant light; steel, wood, black, brown / fabric, cappuccino, gold

Hängeleuchte; Stahl, Holz, schwarz, braun / Textil, cappuccino, gold

luminaire en suspension; acier, bois, noir, marron / tissu, cappuccino, or

H 1100, Ø 160



E27

1x 40W



9 002759 994457



99446 ALBARIZA

pendant light; steel, wood, black, brown / fabric, cappuccino, gold

Hängeleuchte; Stahl, Holz, schwarz, braun / Textil, cappuccino, gold

luminaire en suspension; acier, bois, noir, marron / tissu, cappuccino, or

L 895, B 160, H 1100



E27

3x 40W



9 002759 994464



99447 ALBARIZA

pendant light; steel, wood, black, brown / fabric, cappuccino, gold

Hängeleuchte; Stahl, Holz, schwarz, braun / Textil, cappuccino, gold

luminaire en suspension; acier, bois, noir, marron / tissu, cappuccino, or

H 1500, Ø 700



E27

5x 40W



9 002759 994471





99447





900861



900861

900861 FENIGLIA

table light; steel, black / fabric, linen, natural
Tischleuchte; Stahl, schwarz / Textil, Leinen, natur
luminaire de table; acier, noir / tissu, lin, nature

H 255, Ø 120, Base: Ø 120



E27



1x 40W





900859



900858



EGLO
RECOMMENDS
110042

900858



EGLO
RECOMMENDS
110038

900859 | 900862

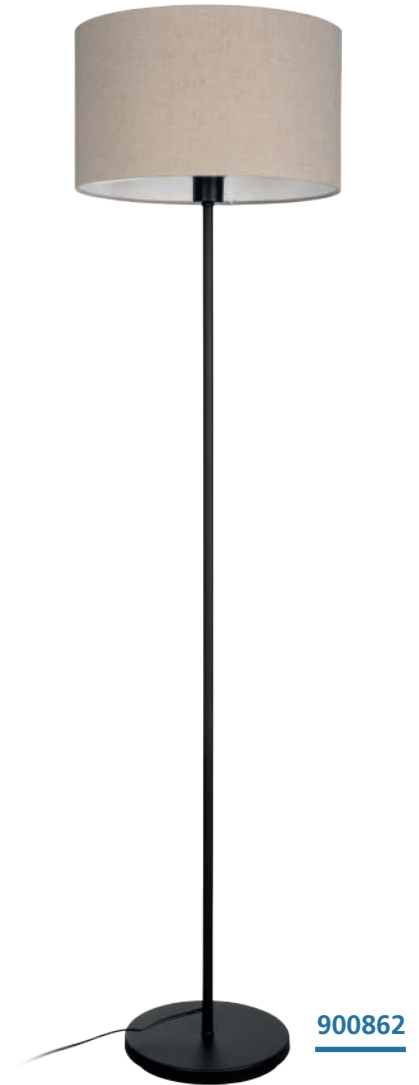

900862

900859 FENIGLIA

pendant light; steel, black / fabric, linen, natural
Hängeleuchte; Stahl, schwarz / Textil, Leinen, natur
luminaire en suspension; acier, noir / tissu, lin, nature

H 1100, Ø 380



E27 1x 40W



9 008606 274413



900858 FENIGLIA

ceiling light; steel, black / fabric, linen, natural
Deckenleuchte; Stahl, schwarz / Textil, Leinen, natur
plafonnier; acier, noir / tissu, lin, nature

H 240, Ø 475



E27 1x 40W



9 008606 274406



900862 FENIGLIA

floor light; steel, black / fabric, linen, natural
Stehleuchte; Stahl, schwarz / Textil, Leinen, natur
lampadaire; acier, noir / tissu, lin, nature

H 1510, Ø 380, Base: Ø 250



E27 1x 40W



9 008606 274437

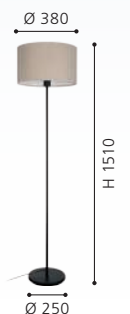



99487 ALMEIDA 2

pendant light; steel, brushed brass / fabric, cappuccino, brass
 Hängeleuchte; Stahl, messing-gebürstet / Textil, cappuccino, messing
 luminaire en suspension; acier, laiton brossé / tissu, cappuccino, laiton

L 1200, B 155, H 1100



E14 5x 40W



9 002759 994877

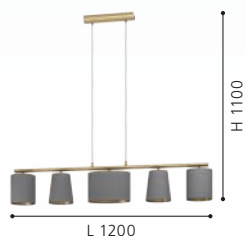

99486 ALMEIDA 2

ceiling light; steel, brushed brass / fabric, cappuccino, brass
 Deckenleuchte; Stahl, messing-gebürstet / Textil, cappuccino, messing
 plafonnier; acier, laiton brossé / tissu, cappuccino, laiton

L 810, B 155, H 280



E14 3x 40W



9 002759 994860

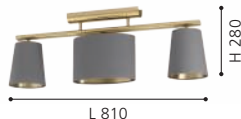

99612 ALMEIDA 2

floor light; steel, brushed brass / fabric, cappuccino, brass
 Stehleuchte; Stahl, messing-gebürstet / Textil, cappuccino, messing
 lampadaire; acier, laiton brossé / tissu, cappuccino, laiton

H 1670, Ø 320, Base: Ø 300



E27 3x 40W



9 002759 996123





99612

99611 ALMEIDA 2

table light; steel, brushed brass / fabric, cappuccino, brass
 Tischleuchte; Stahl, messing-gebürstet / Textil, cappuccino, messing
 luminaire de table; acier, laiton brossé / tissu, cappuccino, laiton

H 605, Ø 260, Base: Ø 200



99611

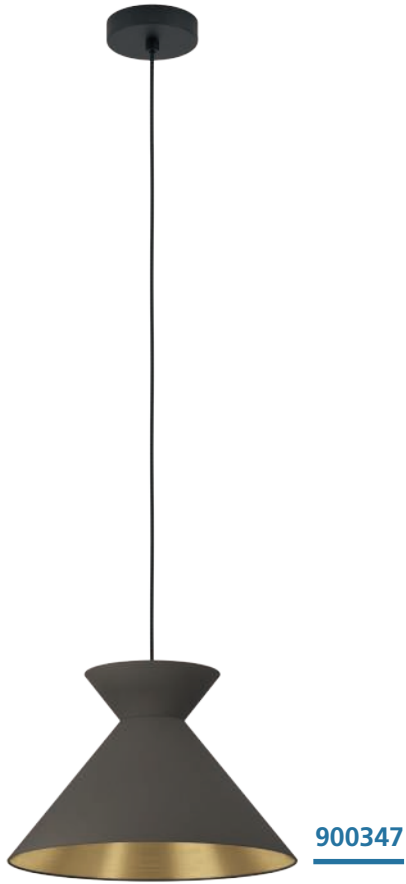

DESIGN
HIGHLIGHT
DETAIL

900347 NASTASIA

pendant light; steel, black / fabric, cappuccino, brass
Hängeleuchte; Stahl, schwarz / Textil, cappuccino, messing
luminaire en suspension; acier, noir / tissu, cappuccino, laiton

H 1100, Ø 380



900348 NASTASIA

pendant light; steel, black / fabric, cappuccino, brass
Hängeleuchte; Stahl, schwarz / Textil, cappuccino, messing
luminaire en suspension; acier, noir / tissu, cappuccino, laiton

L 1000, B 240, H 1100

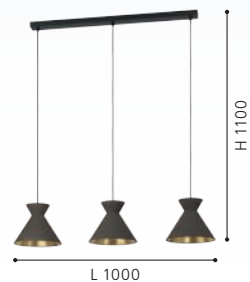

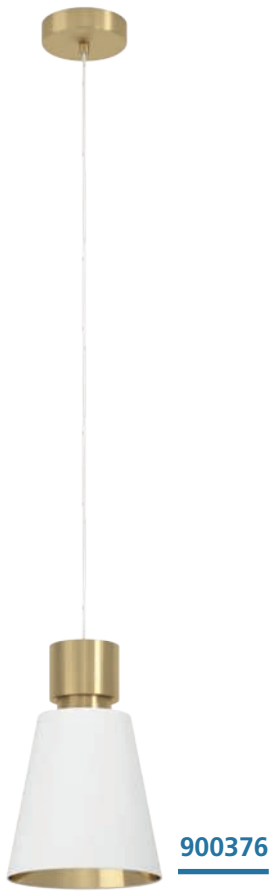

900376

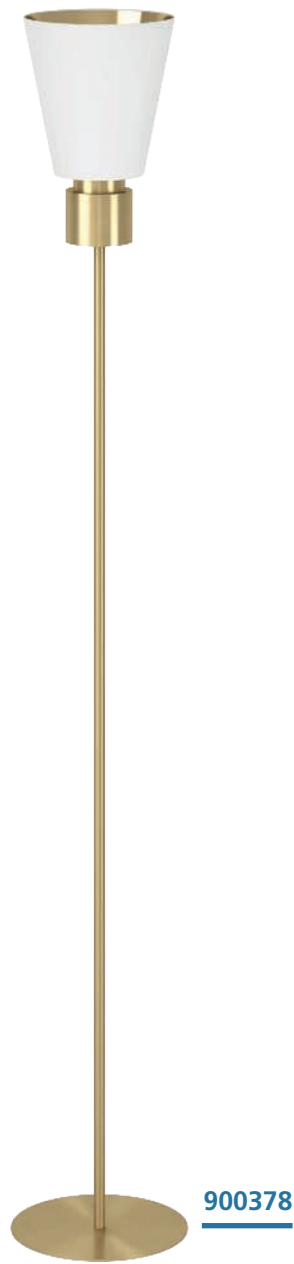

900378



900377

900376 AGLIENTINA

pendant light; steel, brushed brass / fabric, white, brass
 Hängeleuchte; Stahl, messing-gebürstet / Textil, weiss, messing
 luminaire en suspension; acier, laiton brossé / tissu, blanc, laiton

H 1100, Ø 200



E27 1x 40W



9 008606 243587



900378 AGLIENTINA

floor light; steel, brushed brass / fabric, white, brass
 Stehleuchte; Stahl, messing-gebürstet / Textil, weiss, messing
 lampadaire; acier, laiton brossé / tissu, blanc, laiton

H 1700, Ø 200, Base: Ø 250



E27 1x 40W



9 008606 243600



900377 AGLIENTINA

pendant light; steel, brushed brass / fabric, white, brass
 Hängeleuchte; Stahl, messing-gebürstet / Textil, weiss, messing
 luminaire en suspension; acier, laiton brossé / tissu, blanc, laiton

L 900, B 200, H 1100



E27 3x 40W



9 008606 243594





98587 ALMEIDA 1

pendant light; steel, black / fabric, grey, white
 Hängeleuchte; Stahl, schwarz / Textil, grau, weiss
 luminaire en suspension; acier, noir / tissu, gris, blanc

L 860, B 255, H 1100

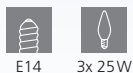

98588 ALMEIDA 1

pendant light; steel, black / fabric, black, grey, white
 Hängeleuchte; Stahl, schwarz / Textil, schwarz, grau, weiss
 luminaire en suspension; acier, noir / tissu, noir, gris, blanc

L 1200, B 255, H 1100





95192



95194



94995

95192 ALMEIDA

ceiling light; steel, black / fabric, anthracite, white, brown
Deckenleuchte; Stahl, schwarz / Textil, anthrazit, weiss, braun
plafonnier; acier, noir / tissu, anthracite, blanc, marron

H 350, Ø 590



E14 3x 40W



9 002759 951924

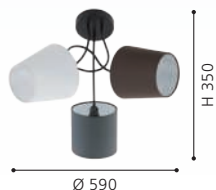

95194 ALMEIDA

table light; steel, black / fabric, white, anthracite
Tischleuchte; Stahl, schwarz / Textil, weiss, anthrazit
luminaire de table; acier, noir / tissu, blanc, anthracite

L 380, B 185, H 475, Base: Ø 155



E14 2x 40W



9 002759 951948



94995 MARONDA

floor light; steel, black / fabric, anthracite, white, brown
Stehleuchte; Stahl, schwarz / Textil, anthrazit, weiss, braun
lampadaire; acier, noir / tissu, anthracite, blanc, marron

L 275, B 35, H 1520, Base: Ø 230



E14 3x 40W



9 002759 949952

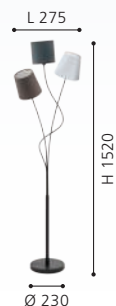

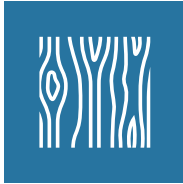

LIGHTING FAMILIES / WOOD LUMINAIRES

LEUCHTENFAMILIEN / HOLZLEUCHTEN
FAMILLES DE LUMINAIRES / LUMINAIRES À BOIS



EN SIMPLE CLASSINESS

The wood luminaires with their unusual designs are perfectly trendy and bring cosiness to every home. Our range of wood luminaires offers a great selection of various shapes, sizes and colours. It contains anything from suspended to table luminaires.

DE SCHLICHTE ELEGANZ

Die Holzleuchten mit ihrem außergewöhnlichen Design sind voll im Trend und sorgen für Gemütlichkeit in jedem Zuhause. Unser Sortiment an Holzleuchten bietet eine große Auswahl an verschiedenen Formen, Größen sowie Farben und reicht von der Hänge- bis hin zur Tischleuchte.

FR ÉLÉGANCE SIMPLE

Les luminaires en bois avec leur design extraordinaire sont très tendance et assurent un confort dans chaque maison. Notre gamme de luminaires en bois offre un grand choix de formes, de tailles et de couleurs différentes et s'étend des luminaires en suspension jusqu'aux luminaires de table.





OVERVIEW

LIGHTING FAMILIES / WOOD LUMINAIRES
LEUCHTENFAMILIEN / HOLZLEUCHTEN
FAMILLES DE LUMINAIRES / LUMINAIRES À BOIS



VELASCO
210-211



BAJAZZARA
212-213



SEGOVIA
214-215



PALOMBAIA
216



RUSTICARIA
217



FATTORIA
218-219



MATTANZA
220



STELLATO 1
220-221



STELLATO 3
221



STELLATO 2
221



TINDORI
222-223



COSSANO
224-225



COSSANO 2
224-225



SENDERO
226-227



This product is available in different colors and shapes. / Dieser Artikel ist in unterschiedlichen Farben und Formen verfügbar. /
Cet article est disponible en différentes couleurs et formes.

WOOD MATERIALS

HOLZ MATERIALIEN / MATÉRIAUX EN BOIS

LAMELLA SHADES / LAMELENSCHIRME / OMBRES À LAMELLES



wood, white
Holz, weiß
bois, blanc



wood, brown
Holz, braun
bois, marron



wood, maple
Holz, ahorn
bois, érable



wood, maple
Holz, ahorn
bois, érable



wood, brown
Holz, braun
bois, marron

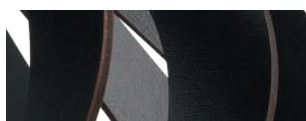

wood, black
Holz, schwarz
bois, noir



wood, grey
Holz, grau
bois, gris



wood, nut
Holz, nuss
bois, noix

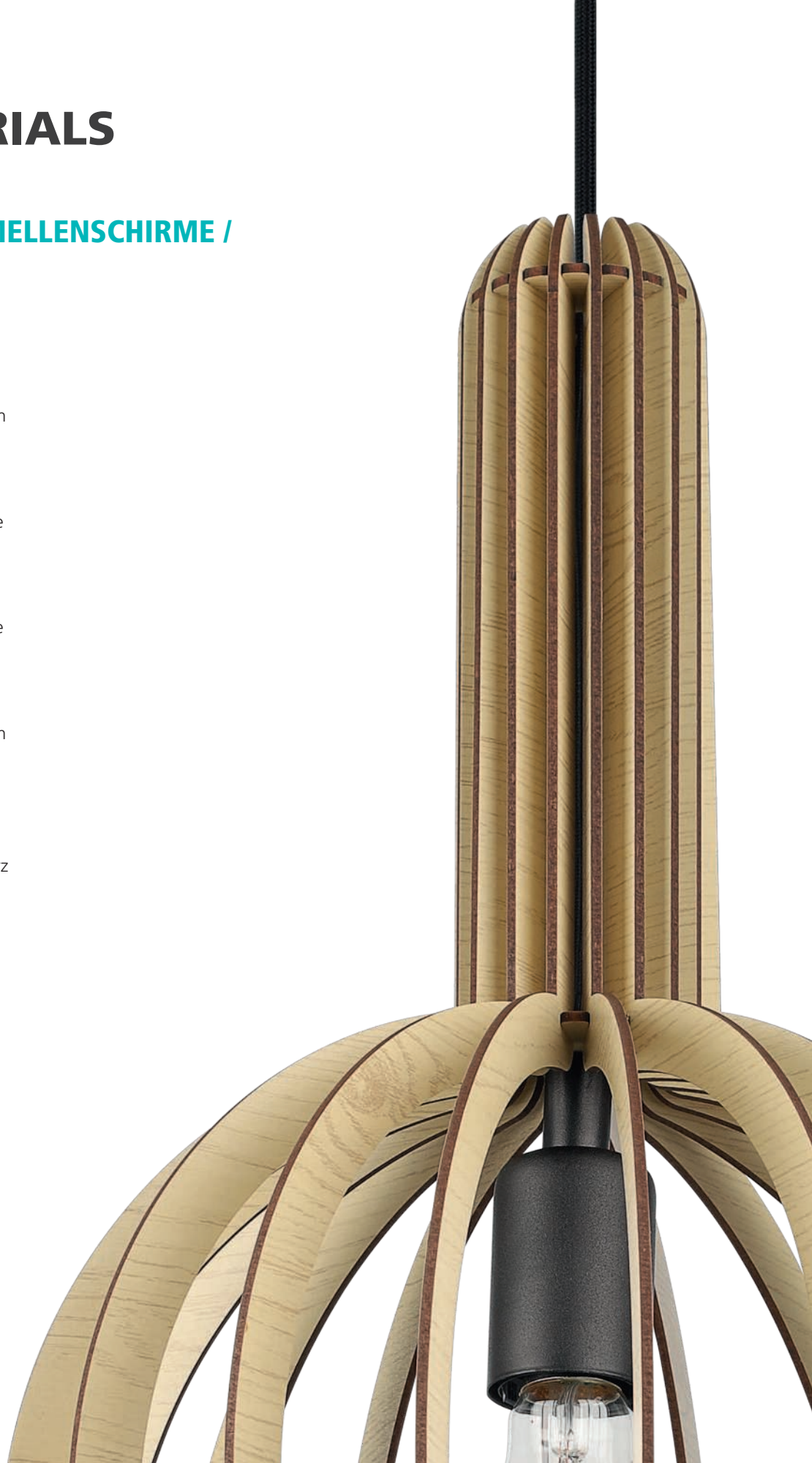

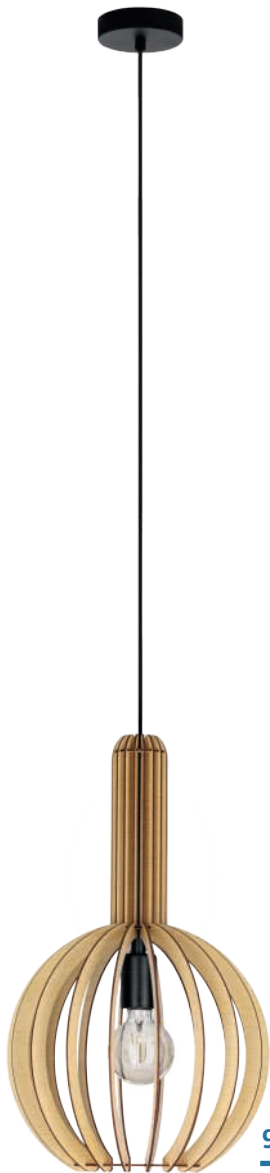

900151



900152

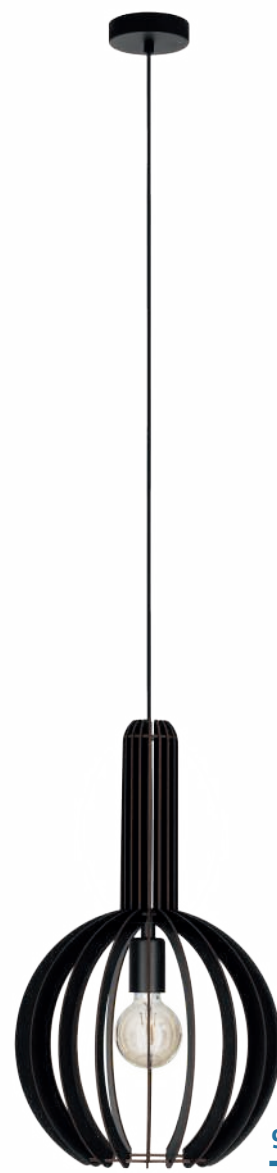

900153

900151 VELASCO

pendant light; steel, black / wood, maple
 Hängeleuchte; Stahl, schwarz / Holz, ahorn
 luminaire en suspension; acier, noir / bois, érable

H 1100, Ø 310

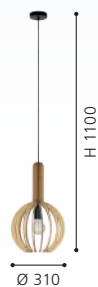

900152 VELASCO

pendant light; steel, black / wood, maple
 Hängeleuchte; Stahl, schwarz / Holz, ahorn
 luminaire en suspension; acier, noir / bois, érable

H 1100, Ø 380

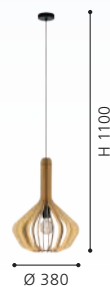

900153 VELASCO

pendant light; steel, black / wood, black
 Hängeleuchte; Stahl, schwarz / Holz, schwarz
 luminaire en suspension; acier, noir / bois, noir

H 1100, Ø 310

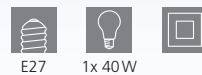



900154



900154 VELASCO

pendant light; steel, black / wood, black
Hängeleuchte; Stahl, schwarz / Holz, schwarz
luminaire en suspension; acier, noir / bois, noir

H 1100, Ø 380



E27



1x 40W



9 008606 224074





900503



900502

900503 BAJAZZARA

pendant light; steel, black / wood, grey
 Hängeleuchte; Stahl, schwarz / Holz, grau
 luminaire en suspension; acier, noir / bois, gris

L 890, B 190, H 1100



900502 BAJAZZARA

pendant light; steel, black / wood, grey
 Hängeleuchte; Stahl, schwarz / Holz, grau
 luminaire en suspension; acier, noir / bois, gris

H 1100, Ø 260

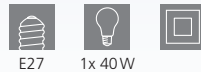



900505



900504

900505 BAJAZZARA

pendant light; steel, black / wood, black
 Hängeleuchte; Stahl, schwarz / Holz, schwarz
 luminaire en suspension; acier, noir / bois, noir

L 890, B 190, H 1100



900504 BAJAZZARA

pendant light; steel, black / wood, black
 Hängeleuchte; Stahl, schwarz / Holz, schwarz
 luminaire en suspension; acier, noir / bois, noir

H 1100, Ø 260

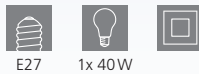



900739

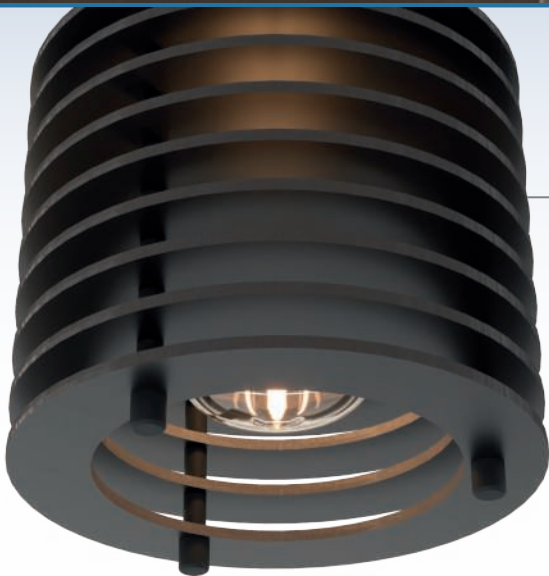

SEGOVIA

Due to the arrangement of the superimposed rings, glare from the light sources is prevented.

Aufgrund der Anordnung der übereinander liegenden Ringe wird das Blendens durch die Leuchtmittel verhindert.

Grâce à la disposition des anneaux superposés, l'éblouissement par les lampes est évité.

900739 SEGOVIA

spot; steel, black / wood, black
Spot; Stahl, schwarz / Holz, schwarz
spot; acier, noir / bois, noir

L 130, H 195, A 175



E27



1x 40W

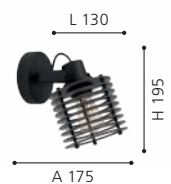



900741



900742



900738



900739 | 900741 | 900742



900738

900741 SEGOVIA

spot; steel, black / wood, black
Spot; Stahl, schwarz / Holz, schwarz
spot; acier, noir / bois, noir

L 335, H 185, A 175



E27 2x 40W



9 008606 267156



L 335

H 185

900742 SEGOVIA

spot; steel, black / wood, black
Spot; Stahl, schwarz / Holz, schwarz
spot; acier, noir / bois, noir

L 575, H 185, A 175



E27 3x 40W



9 008606 267163



L 575

H 185

900738 SEGOVIA

pendant light; steel, black / wood, black
Hängeleuchte; Stahl, schwarz / Holz, schwarz
luminaire en suspension; acier, noir / bois, noir

L 880, B 180, H 1100



E27 3x 40W



9 008606 267132

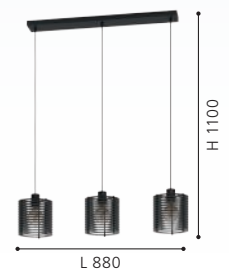

L 880

H 1100

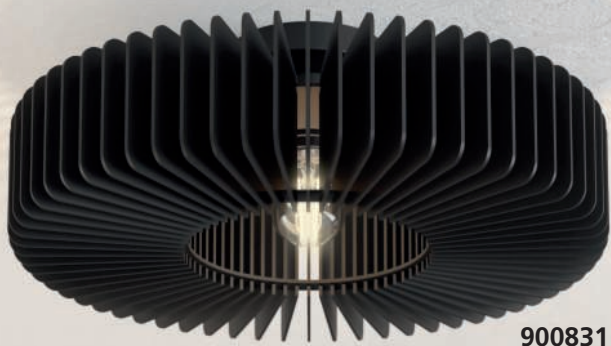

900831

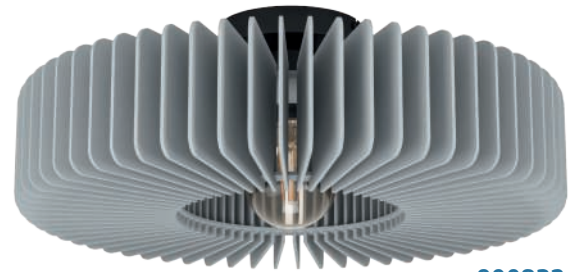

900832

900831 PALOMBAIA

ceiling light; steel, black / wood, black
Deckenleuchte; Stahl, schwarz / Holz, schwarz
plafonnier; acier, noir / bois, noir

H 175, Ø 500



E27



1x 40W



9 008606 274024

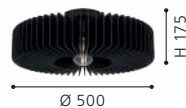

900832 PALOMBAIA

ceiling light; steel, black / wood, grey
Deckenleuchte; Stahl, schwarz / Holz, grau
plafonnier; acier, noir / bois, gris

H 175, Ø 500



E27



1x 40W



9 008606 274031

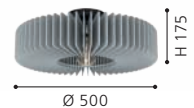

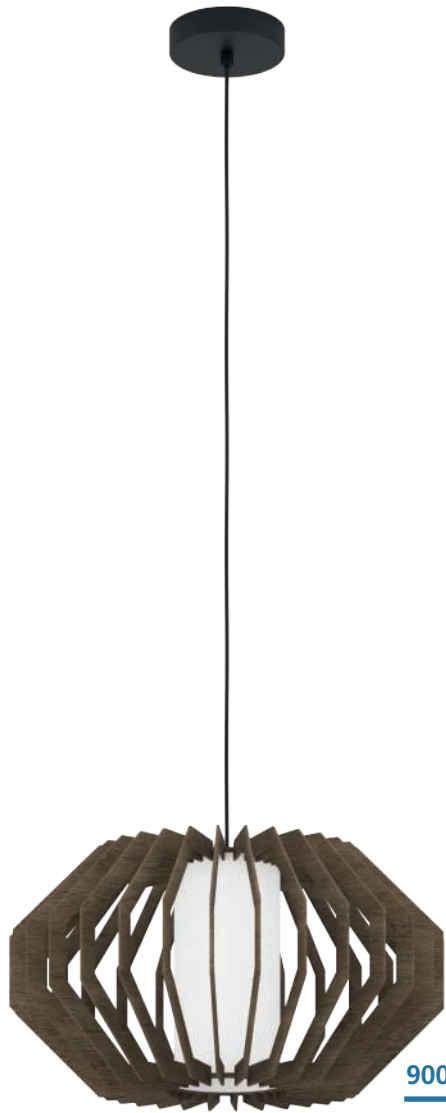

900386



900385



900386 RUSTICARIA

pendant light; steel, black / wood, glass, brown, white
Hängeleuchte; Stahl, schwarz / Holz, Glas, braun, weiss
luminaire en suspension; acier, noir / bois, verre, marron, blanc

H 1100, Ø 450

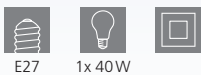

E27 1x 40W



9 008606 240043



900385 RUSTICARIA

ceiling light; steel, black / wood, glass, brown, white
Deckenleuchte; Stahl, schwarz / Holz, Glas, braun, weiss
plafonnier; acier, noir / bois, verre, marron, blanc

H 275, Ø 450



E27 1x 40W



9 008606 240036





900904

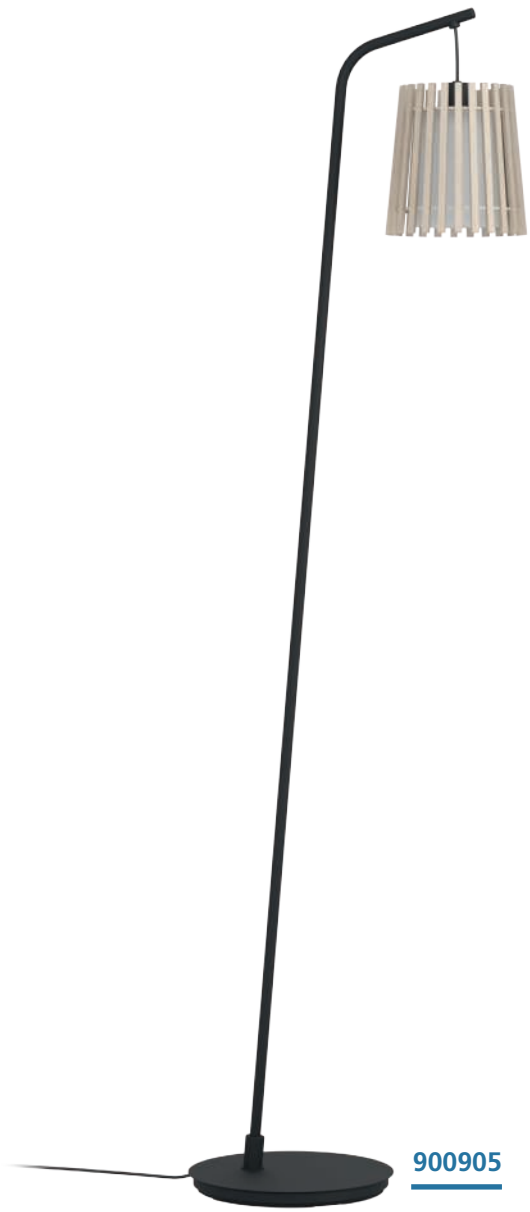

900905

900904 FATTORIA

table light; steel, black / wood, fabric, brown, white
Tischleuchte; Stahl, schwarz / Holz, Textil, braun, weiss
luminaire de table; acier, noir / bois, tissu, marron, blanc

H 450, Ø 200, Base: Ø 180



900905 FATTORIA

floor light; steel, black / wood, fabric, brown, white
Stehleuchte; Stahl, schwarz / Holz, Textil, braun, weiss
lampadaire; acier, noir / bois, tissu, marron, blanc

L 495, B 200, H 1700, Base: Ø 300

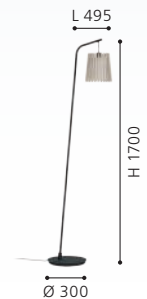

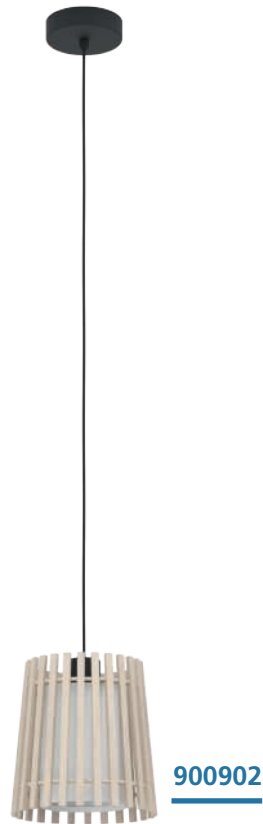

900902



900901



900901



900903



900905 | 900902



900903 | 900904

900902 FATTORIA

pendant light; steel, black / wood, fabric, brown, white
Hängeleuchte; Stahl, schwarz / Holz, Textil, braun, weiss
luminaire en suspension; acier, noir / bois, tissu, marron, blanc

H 1100, Ø 200



E27 1x 25W



9 008606 274727



900903 FATTORIA

pendant light; steel, black / wood, fabric, brown, white
Hängeleuchte; Stahl, schwarz / Holz, Textil, braun, weiss
luminaire en suspension; acier, noir / bois, tissu, marron, blanc

L 900, B 200, H 1100



E27 3x 25W



9 008606 274734



900901 FATTORIA

ceiling light; steel, black / wood, fabric, brown, white
Deckenleuchte; Stahl, schwarz / Holz, Textil, braun, weiss
plafonnier; acier, noir / bois, tissu, marron, blanc

H 240, Ø 380

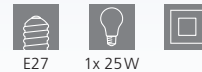

E27 1x 25W



9 008606 274710

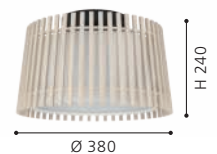



900847



95597



95602

900847 MATTANZA

pendant light; steel, black / wood, grey
Hängeleuchte; Stahl, schwarz / Holz, grau
luminaire en suspension; acier, noir / bois, gris

H 2465, Ø 495



95597 STELLATO 1

ceiling light; steel, satin nickel / wood, glass, maple, white
Deckenleuchte; Stahl, nickel-matt / Holz, Glas, ahorn, weiss
plafonnier; acier, nickel mat / bois, verre, érable, blanc

H 275, Ø 400

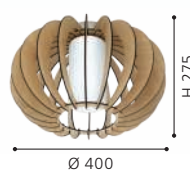

95602 STELLATO 1

wall light; steel, white / wood, glass, maple, white
Wandleuchte; Stahl, weiss / Holz, Glas, ahorn, weiss
Applique; acier, blanc / bois, verre, érable, blanc

L 285, H 250, A 140

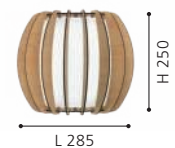



EGLO
RECOMMENDS
110033

STELLATO 1
STELLATO 2

95591

95598

95606

95598 STELLATO 1

pendant light; steel, satin nickel / wood, glass, maple, white
Hängeleuchte; Stahl, nickel-matt / Holz, Glas, ahorn, weiss
luminaire en suspension; acier, nickel mat / bois, verre, érable, blanc

H 1300, Ø 400



95591 STELLATO 3

pendant light; steel, satin nickel / wood, glass, brown, white
Hängeleuchte; Stahl, nickel-matt / Holz, Glas, braun, weiss
luminaire en suspension; acier, nickel mat / bois, verre, marron, blanc

H 1300, Ø 400

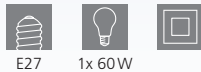

95606 STELLATO 2

pendant light; steel, white / wood, glass, white
Hängeleuchte; Stahl, weiss / Holz, Glas, weiss
luminaire en suspension; acier, blanc / bois, verre, blanc

H 1300, Ø 400





96211



96257

96211 TINDORI

pendant light; steel, satin nickel / wood, glass, white
 Hängeleuchte; Stahl, nickel-matt / Holz, Glas, weiss
 luminaire en suspension; acier, nickel mat / bois, verre, blanc

H 1500, Ø 500



E27



1x 60W



9 002759 962111



96257 TINDORI

pendant light; steel, satin nickel / wood, white
 Hängeleuchte; Stahl, nickel-matt / Holz, weiss
 luminaire en suspension; acier, nickel mat / bois, blanc

H 1300, Ø 380



E27



1x 60W



9 002759 962579





96258



96214



96211 | 96214

96258 TINDORI

pendant light; steel, satin nickel / wood, maple
 Hängeleuchte; Stahl, nickel-matt / Holz, ahorn
 luminaire en suspension; acier, nickel mat / bois, érable

H 1300, Ø 380

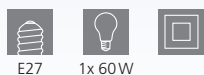

9 002759 962586



96214 TINDORI

pendant light; steel, satin nickel / wood, glass, maple, white
 Hängeleuchte; Stahl, nickel-matt / Holz, Glas, ahorn, weiss
 luminaire en suspension; acier, nickel mat / bois, verre, érable, blanc

H 1500, Ø 500



9 002759 962142



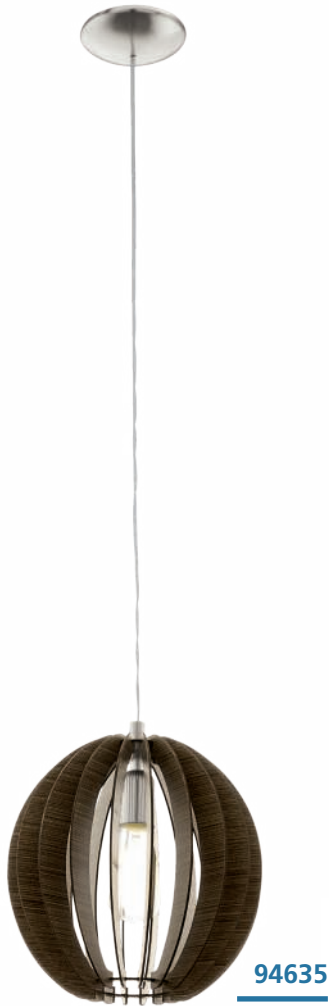

94635 COSSANO

pendant light; steel, satin nickel / wood, brown
 Hängeleuchte; Stahl, nickel-matt / Holz, braun
 luminaire en suspension; acier, nickel mat / bois, marron

H 1300, Ø 300



94636 COSSANO

pendant light; steel, satin nickel / wood, brown
 Hängeleuchte; Stahl, nickel-matt / Holz, braun
 luminaire en suspension; acier, nickel mat / bois, marron

H 1500, Ø 500

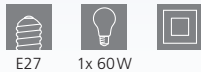

95261 COSSANO 2

pendant light; steel, satin nickel / wood, dark brown
 Hängeleuchte; Stahl, nickel-matt / Holz, dunkelbraun
 luminaire en suspension; acier, nickel mat / bois, marron foncé

H 1500, Ø 500

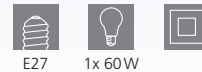

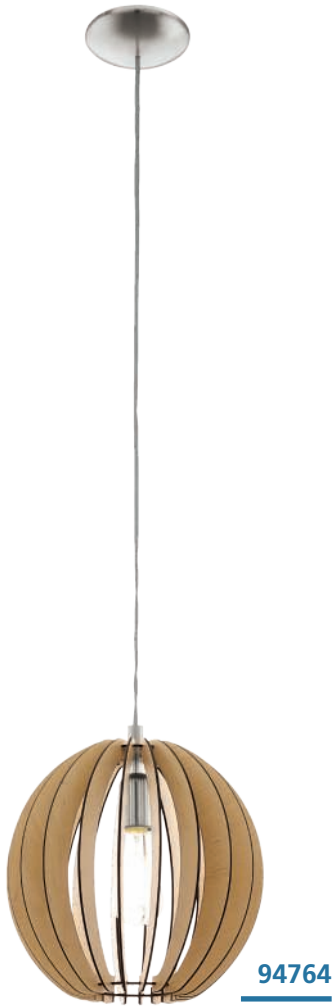

94764 COSSANO

pendant light; steel, satin nickel / wood, maple
 Hängeleuchte; Stahl, nickel-matt / Holz, ahorn
 luminaire en suspension; acier, nickel mat / bois, érable

H 1300, Ø 300

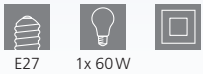

94765 COSSANO

pendant light; steel, satin nickel / wood, maple
 Hängeleuchte; Stahl, nickel-matt / Holz, ahorn
 luminaire en suspension; acier, nickel mat / bois, érable

H 1500, Ø 500

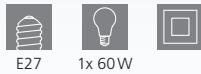

95257 COSSANO 2

pendant light; steel, satin nickel / wood, maple
 Hängeleuchte; Stahl, nickel-matt / Holz, ahorn
 luminaire en suspension; acier, nickel mat / bois, érable

H 1500, Ø 500

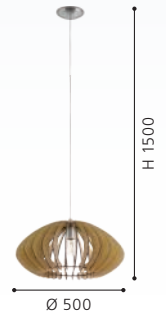
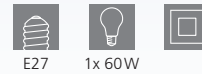



96194



96195



96193

96194 SENDERO

pendant light; steel, satin nickel / wood, maple
Hängeleuchte; Stahl, nickel-matt / Holz, ahorn
luminaire en suspension; acier, nickel mat / bois, érable

L 775, B 250, H 1300



E27



2x 60W



9 002759 961947



L 775

H 1300

96193 SENDERO

pendant light; steel, satin nickel / wood, maple
Hängeleuchte; Stahl, nickel-matt / Holz, ahorn
luminaire en suspension; acier, nickel mat / bois, érable

H 1300, Ø 450



E27



1x 60W



9 002759 961930



Ø 450

H 1300

96195 SENDERO

wall light; steel, white / wood, maple
Wandleuchte; Stahl, weiss / Holz, ahorn
applique; acier, blanc / bois, érable

L 240, H 220, A 120



E27



1x 60W



9 002759 961954



A 120

H 220



96199



96201

96199 SENDERO

pendant light; steel, satin nickel / wood, brown
 Hängeleuchte; Stahl, nickel-matt / Holz, braun
 luminaire en suspension; acier, nickel mat / bois, marron

H 1300, Ø 450



9 002759 961992



96201 SENDERO

pendant light; steel, satin nickel / wood, brown
 Hängeleuchte; Stahl, nickel-matt / Holz, braun
 luminaire en suspension; acier, nickel mat / bois, marron

L 775, B 250, H 1300

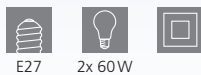

9 002759 962012





LIGHTING FAMILIES / ESSENTIAL LUMINAIRES

LEUCHTENFAMILIEN / STANDARD LEUCHTEN
FAMILLES DE LUMINAIRES / LUMINAIRES ESSENTIEL

EN **FAMILY MEETING**

This range combines ceiling, wall, suspended, floor and table luminaires. Give your rooms a consistent and stylish all-round illumination.

DE **FAMILIENTREFFEN**

Dieses Sortiment vereint sowohl Decken-, Wand- und Hängeleuchten als auch Tisch- und Stehleuchten. Verleihen Sie Ihren Räumlichkeiten eine einheitliche und stilvolle Rundumbeleuchtung.

FR **RENCONTRE FAMILIALE**

Cette gamme réunit aussi bien des plafonniers, des éclairages muraux, des éclairages suspendus que des lampes de table et des lampadaires. Donnez à vos pièces un éclairage d'ensemble unifié et riche en style.





























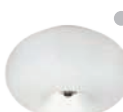

















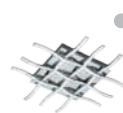

OVERVIEW

LIGHTING FAMILIES / ESSENTIAL LUMINAIRS
LEUCHTENFAMILIEN / STANDARD LEUCHTEN
FAMILLES DE LUMINAIRES / LUMINAIRES ESSENTIEL

 TURALDO 232	 LIBERTAD 234, 236	 LIBERTAD 1 235	 CAMACHO 238-239	 BOYAL 240-243	 PANAGRIA 244-245	 CANTERRAS 246-247	 ABREOSA 248
 ALMUDAINA 250-251	 CASIBARE 252-253	 CREMELLA 254-255	 ROMAZZINA 256-259	 VENEZUELA 260-261	 ESCANDIDOS 262-263	 LURONE 264-265	 ESCANDELL 266-267
 NARICES 1 268	 NARICES 268-269	 BARBOTTO 270-273	 ERSEKA 274-275	 MANZANARES 276-277	 RONDO 278-280	 RONDO 3 280	 OPTICA 282-284
 GOROSIBA 1 286	 GOROSIBA 286-287	 PINTO TEXTIL 1 288	 PINTO TEXTIL 289	 PINTO NERO 290	 PINTO GOLD 292-293	 PINTO 294-295	 TROY 3 296-297
 RIVATO 298	 BAYMAN 299	 VINOVO 300	 MURCIA 300-301	 SAVOY 302-303	 MARBELLA 304-305	 ERVIDEL 306-307	 CLAVELLINA 308-309
 ISIDRO 310-311	 CARANACOA 312-313	 VALLEROSA 314-315	 CODRIALES 316-317	 GIANELLA 318-319	 SIBERIA 320-321	 LEJIAS 322-323	 LASANA 1 324, 329
 LASANA 2 324-325	 LASANA 3 326-327	 LASANA 328	 TARANDELL 329	 RONCADE 1 330	 SELVINA 1 330	 RONCADE 331, 334	 SELVINA 331-332, 335



This product is available in different colors and shapes. / Dieser Artikel ist in unterschiedlichen Farben und Formen verfügbar. / Cet article est disponible en différentes couleurs et formes.

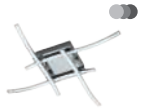

VALMORA
332-333



NEVADO
333



PALOZZA 1
334



PALOZZA
335





DESIGN
HIGHLIGHT
DETAIL



99077



99079

99077 TURALDO

ceiling light; wood, brown
Deckenleuchte; Holz, braun
plafonnier; bois, marron

H 80, Ø 70

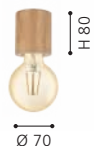
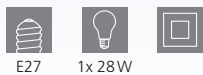

99079 TURALDO

table light; wood, brown
Tischleuchte; Holz, braun
luminaire de table; bois, marron

H 100, Ø 85

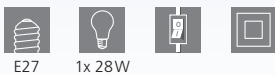

99078 TURALDO

pendant light; wood, steel, brown, black
Hängeleuchte; Holz, Stahl, braun, schwarz
luminaire en suspension; bois, acier, marron, noir

H 1100, Ø 105

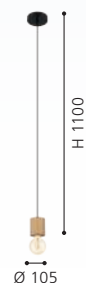
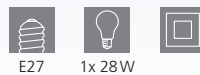



99078



99795

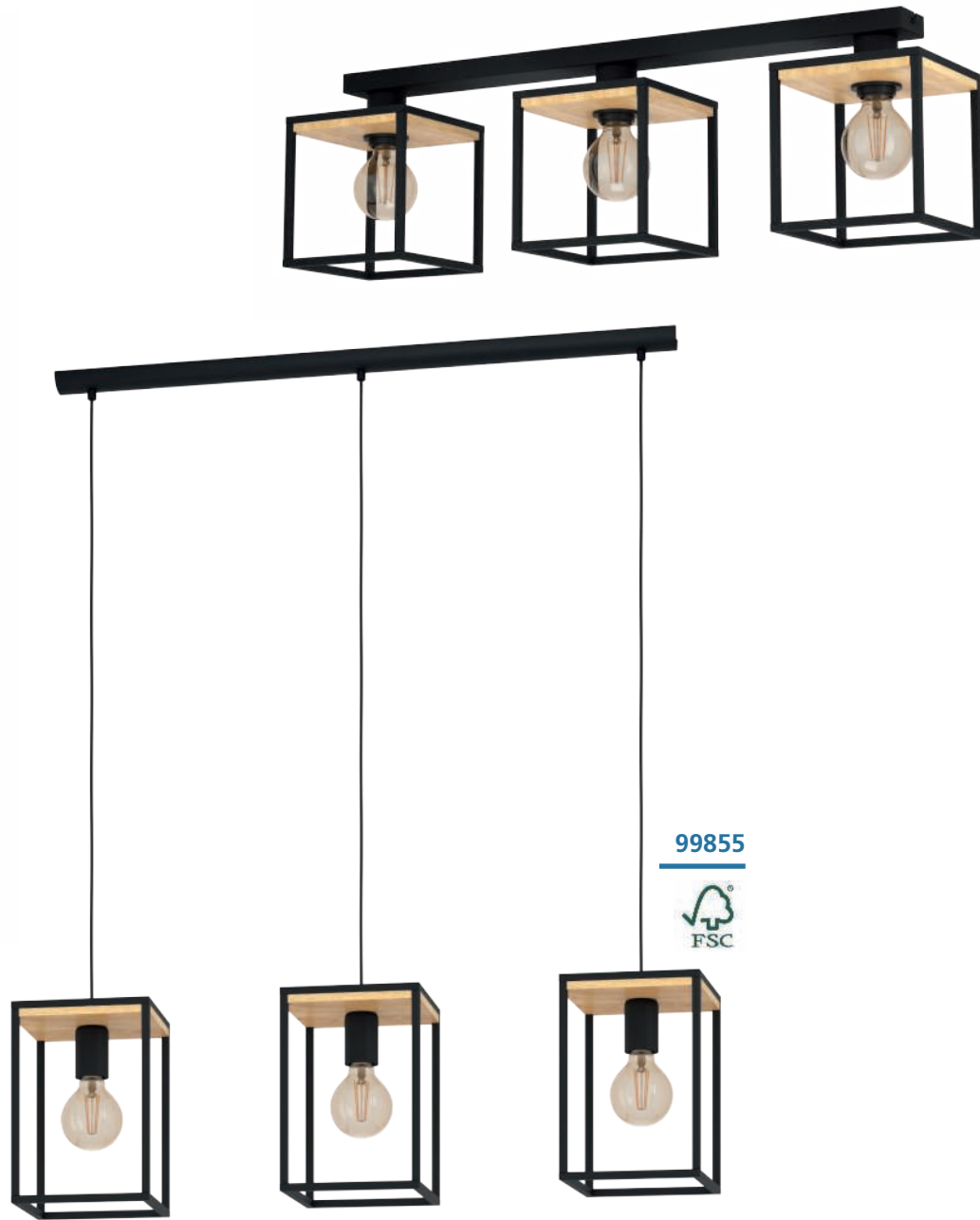

99856



99855



99795 LIBERTAD

pendant light; steel, wood, black, brown
 Hängeleuchte; Stahl, Holz, schwarz, braun
 luminaire en suspension; acier, bois, noir, marron

L 180, B 180, H 1100

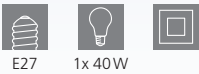

E27 1x 40W



9 002759 997953



99855 LIBERTAD

pendant light; steel, wood, black, brown
 Hängeleuchte; Stahl, Holz, schwarz, braun
 luminaire en suspension; acier, bois, noir, marron

L 880, B 180, H 1100



E27 3x 40W



9 002759 998554



99856 LIBERTAD

ceiling light; steel, wood, black, brown
 Deckenleuchte; Stahl, Holz, schwarz, braun
 plafonnier; acier, bois, noir, marron

L 860, B 180, H 240



E27 3x 40W



9 002759 998561





900349



900349 LIBERTAD 1

pendant light; steel, wood, black, brown
 Hängeleuchte; Stahl, Holz, schwarz, braun
 luminaire en suspension; acier, bois, noir, marron

L 760, B 140, H 1100



E27



3x 40W



9 008606 243501

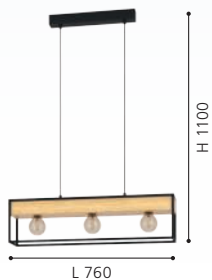

900349

The flower pots are included in these luminaires.

Bei diesen Leuchten sind die Blumentöpfe inkludiert.

Les pots de fleurs sont inclus dans ces luminaires.





99796



99798



99796 LIBERTAD

wall light; steel, wood, black, brown
Wandleuchte; Stahl, Holz, schwarz, braun
Applique; acier, bois, noir, marron

L 140, H 240, A 165



E27 1x 40W



9 002759 997960



99798 LIBERTAD

floor light; steel, wood, black, brown
Stehleuchte; Stahl, Holz, schwarz, braun
lampadaire; acier, bois, noir, marron

L 180, B 180, H 1285



E27 1x 40W



9 002759 997984



99797 LIBERTAD

table light; steel, wood, black, brown
Tischleuchte; Stahl, Holz, schwarz, braun
luminaire de table; acier, bois, noir, marron

L 140, B 140, H 350



E27 1x 40W



9 002759 997977





99797





99293 CAMACHO

pendant light; steel, wood, black, brown / plastic, white
 Hängeleuchte; Stahl, Holz, schwarz, braun / Kunststoff, weiss
 luminaire en suspension; acier, bois, noir, marron / plastique, blanc

L 1100, B 60, H 1100

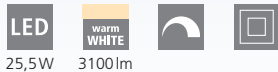

25,5W 3100lm



9 002759 992934

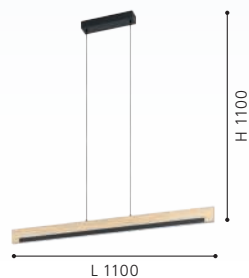

99292 CAMACHO

ceiling light; steel, wood, black, brown / plastic, white
 Deckenleuchte; Stahl, Holz, schwarz, braun / Kunststoff, weiss
 plafonnier; acier, bois, noir, marron / plastique, blanc

L 940, B 80, H 115



2x 10W 2600lm



9 002759 992927

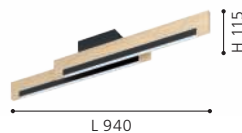

99294 CAMACHO

wall light; steel, wood, black, brown / plastic, white
 Wandleuchte; Stahl, Holz, schwarz, braun / Kunststoff, weiss
 Applique; acier, bois, noir, marron / plastique, blanc

L 440, H 105, A 75



1x 9,6W 1050lm



9 002759 992941



TOUCH
ME



99296

LED



99295

LED

99295, 99296

These luminaires can be switched on and off by touching the specially designed "Touch Me" part of the fixture.

Diese Leuchten können ein- und ausgeschaltet werden, indem man sie an den dafür vorgesehenen „Touch Me“ Bereichen berührt.

Ces luminaires peuvent être éteints et allumés simplement en touchant la partie spécialement conçue pour «Touch Me» du luminaire.

99296 CAMACHO

floor light; steel, wood, black, brown / plastic, white
Stehleuchte; Stahl, Holz, schwarz, braun / Kunststoff, weiss
lampadaire; acier, bois, noir, marron / plastique, blanc

L 75, B 20, H 1260, Base: B 250, T 200

LED

19,5 W

warm
WHITE

2400lm



9 002759 992965

99295 CAMACHO

table light; steel, wood, black, brown / plastic, white
Tischleuchte; Stahl, Holz, schwarz, braun / Kunststoff, weiss
luminaire de table; acier, bois, noir, marron / plastique, blanc

L 75, B 20, H 405, Base: B 150, T 130

LED

1x 6,5 W

warm
WHITE

800lm



9 002759 992958



99624 BOYAL

pendant light; steel, wood, black, brown rustic / plastic, white
 Hängeleuchte; Stahl, Holz, schwarz, braun rustikal / Kunststoff, weiss
 luminaire en suspension; acier, bois, noir, marron rustique / plastique, blanc

L 1010, B 400, H 1100

LED warm WHITE LED warm WHITE

2x 12,5W 3600lm 1x 15,5W 2250lm

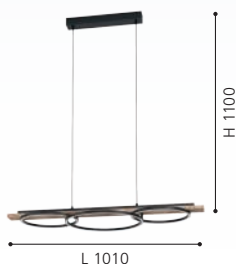

9 002759 996246

99413 BOYAL

ceiling light; steel, wood, black, brown rustic / plastic, white
 Deckenleuchte; Stahl, Holz, schwarz, braun rustikal / Kunststoff, weiss
 plafonnier; acier, bois, noir, marron rustique / plastique, blanc

L 1010, B 400, H 95

LED warm WHITE LED warm WHITE

2x 12W 3400lm 1x 12W 1700lm

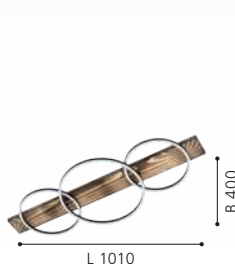

9 002759 994136

99408 BOYAL

ceiling light; steel, wood, black, brown rustic / plastic, white
 Deckenleuchte; Stahl, Holz, schwarz, braun rustikal / Kunststoff, weiss
 plafonnier; acier, bois, noir, marron rustique / plastique, blanc

L 780, B 400, H 90

LED warm WHITE LED warm WHITE

1x 12W 1700lm 1x 12W 1700lm

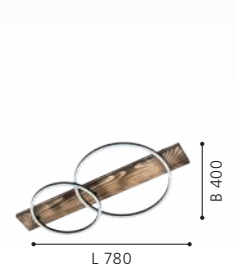

9 002759 994082



99353



99457



900892



99353 BOYAL

wall light; steel, wood, black, brown rustic / plastic, white
 Wandleuchte; Stahl, Holz, schwarz, braun rustikal / Kunststoff, weiss
 Applique; acier, bois, noir, marron rustique / plastique, blanc

L 300, H 560, A 75



1x 12W 1700lm



9 002759 993535



99457 BOYAL

table light; steel, wood, black, brown rustic / plastic, white
 Tischleuchte; Stahl, Holz, schwarz, braun rustikal / Kunststoff, weiss
 luminaire de table; acier, bois, noir, marron rustique / plastique, blanc

L 300, B 150, H 425, Base: B 110, T 150



1x 12W 1700lm



9 002759 994570



900892 BOYAL

floor light; steel, wood, black, brown rustic / plastic, white
 Stehleuchte; Stahl, Holz, schwarz, braun rustikal / Kunststoff, weiss
 lampadaire; acier, bois, noir, marron rustique / plastique, blanc

L 300, H 1500, Base: B 250, T 200



2x 12W 3400lm



9 008606 274574





99625 BOYAL

pendant light; steel, wood, black, brown / plastic, white
 Hängeleuchte; Stahl, Holz, schwarz, braun / Kunststoff, weiss
 luminaire en suspension; acier, bois, noir, marron / plastique, blanc

L 1010, B 400, H 1100

LED warm WHITE LED warm WHITE

2x 12,5W 3600lm 1x 15,5W 2250lm



9 002759 996253

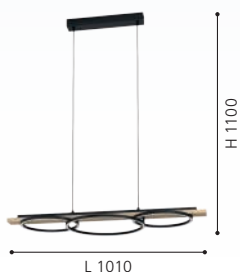

99468 BOYAL

ceiling light; steel, wood, black, brown / plastic, white
 Deckenleuchte; Stahl, Holz, schwarz, braun / Kunststoff, weiss
 plafonnier; acier, bois, noir, marron / plastique, blanc

L 1010, B 400, H 95

LED warm WHITE LED warm WHITE

2x 12W 3400lm 1x 12W 1700lm



9 002759 994686

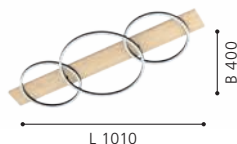

99467 BOYAL

ceiling light; steel, wood, black, brown / plastic, white
 Deckenleuchte; Stahl, Holz, schwarz, braun / Kunststoff, weiss
 plafonnier; acier, bois, noir, marron / plastique, blanc

L 780, B 400, H 90

LED warm WHITE LED warm WHITE

1x 12W 1700lm 1x 12W 1700lm



9 002759 994679

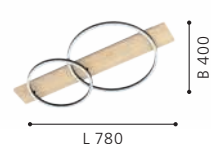



99469

LED



99466

LED

99469 BOYAL

table light; steel, wood, black, brown / plastic, white
Tischleuchte; Stahl, Holz, schwarz, braun / Kunststoff, weiss
luminaire de table; acier, bois, noir, marron / plastique, blanc

L 300, B 150, H 425, Base: B 110, T 150



1x 12W 1700lm



9 002759 994693



99466 BOYAL

wall light; steel, wood, black, brown / plastic, white
Wandleuchte; Stahl, Holz, schwarz, braun / Kunststoff, weiss
Applique; acier, bois, noir, marron / plastique, blanc

L 300, H 560, A 75



1x 12W 1700lm



9 002759 994662

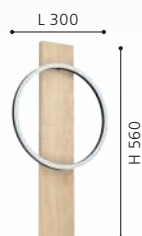



900489



900488



900491



900489 PANAGRIA

pendant light; aluminium, steel, wood, black, brown / plastic, white

Hängeleuchte; Alu, Stahl, Holz, schwarz, braun / Kunststoff, weiss

luminaire en suspension; aluminium, acier, bois, noir, marron / plastique, blanc

L 935, B 75, H 1100



2x 13W 3120lm



9 008606 244249

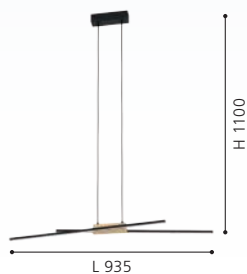

900488 PANAGRIA

ceiling light; aluminium, steel, wood, black, brown / plastic, white

Deckenleuchte; Alu, Stahl, Holz, schwarz, braun / Kunststoff, weiss

plafonnier; aluminium, acier, bois, noir, marron / plastique, blanc

L 935, B 75, H 110



2x 13W 3120lm



9 008606 244232

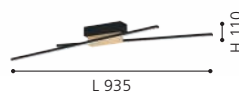

900491 PANAGRIA

wall light; aluminium, steel, wood, black, brown / plastic, white

Wandleuchte; Alu, Stahl, Holz, schwarz, braun / Kunststoff, weiss

Applique; aluminium, acier, bois, noir, marron / plastique, blanc

L 75, H 540, A 85



2x 6,3W 1510lm



9 008606 244256





DESIGN
HIGHLIGHT
DETAIL

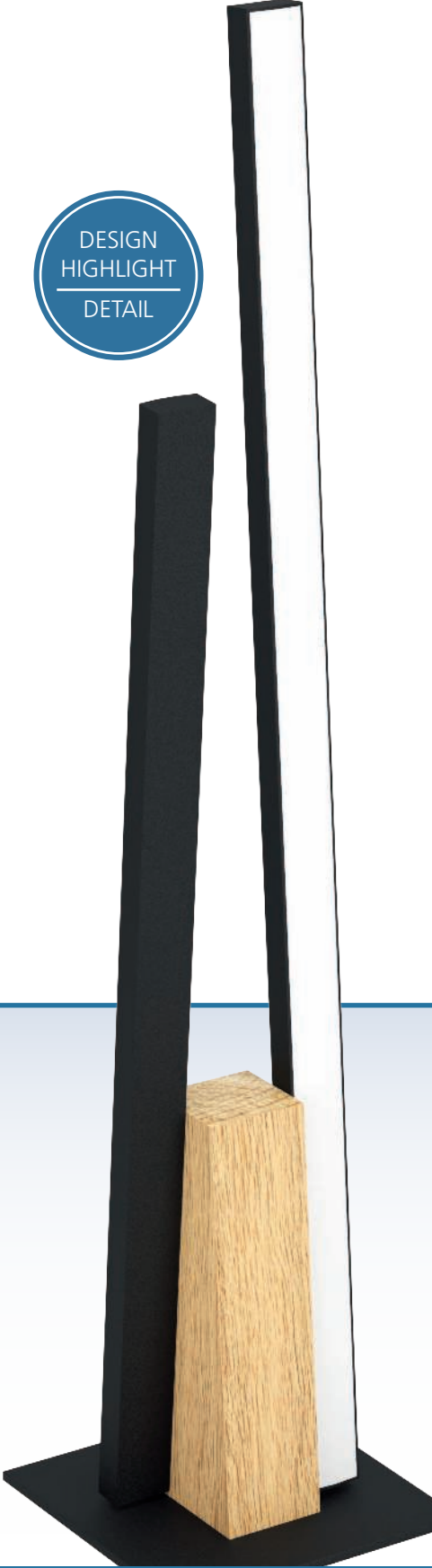

900492 PANAGRIA

table light; aluminium, steel, wood, black, brown / plastic, white
Tischleuchte; Alu, Stahl, Holz, schwarz, braun / Kunststoff, weiss
luminaire de table; aluminium, acier, bois, noir, marron /
plastique, blanc

L 75, B 45, H 455, Base: B 100, T 100



1x 6,8W 1440lm 1x 5,2W



9 008606 244263



900493 PANAGRIA

floor light; aluminium, steel, wood, black, brown / plastic, white
Stehleuchte; Alu, Stahl, Holz, schwarz, braun / Kunststoff, weiss
lampadaire; aluminium, acier, bois, noir, marron / plastique,
blanc

L 85, B 75, H 1460, Base: B 160, T 160

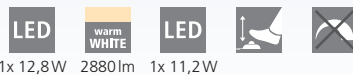

1x 12,8W 2880lm 1x 11,2W



9 008606 244270





99545



99544

99545 CANTERRAS

pendant light; steel, black / terrazzo, grey, white
 Hängeleuchte; Stahl, schwarz / Terrazzo, grau, weiss
 luminaire en suspension; acier, noir / terrazzo, gris, blanc

L 975, B 150, H 1100



99544 CANTERRAS

pendant light; steel, black / terrazzo, grey, white
 Hängeleuchte; Stahl, schwarz / Terrazzo, grau, weiss
 luminaire en suspension; acier, noir / terrazzo, gris, blanc

H 1100, Ø 150

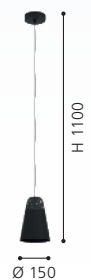
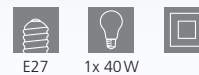



99546



99547



99546 CANTERRAS

wall light; steel, black / terrazzo, grey, white
 Wandleuchte; Stahl, schwarz / Terrazzo, grau, weiss
 Applique; acier, noir / terrazzo, gris, blanc

L 150, H 320, A 275



9 002759 995461



99547 CANTERRAS

floor light; steel, black / terrazzo, grey, white
 Stehleuchte; Stahl, schwarz / Terrazzo, grau, weiss
 lampadaire; acier, noir / terrazzo, gris, blanc

L 430, B 150, H 1785, Base: Ø 300

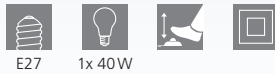

9 002759 995478



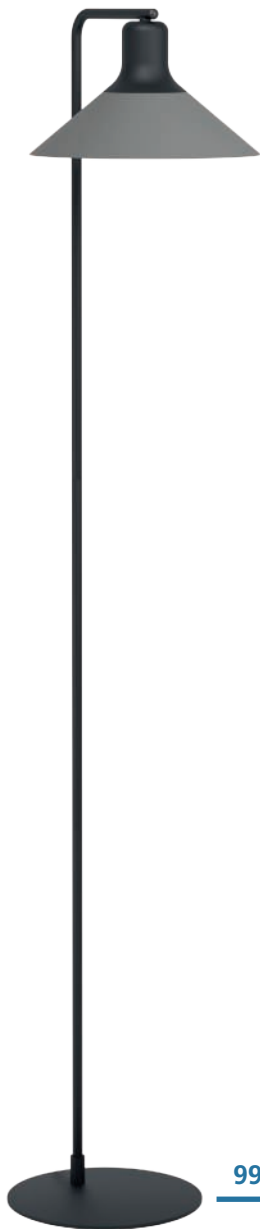

99513



99512

99513 ABREOSA

floor light; steel, black, grey
Stehleuchte; Stahl, schwarz, grau
lampadaire; acier, noir, gris

L 370, B 280, H 1510, Base: Ø 250

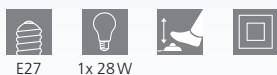

E27 1x 28W



9 002759 995133

99512 ABREOSA

pendant light; steel, black, grey
Hängeleuchte; Stahl, schwarz, grau
luminaire en suspension; acier, noir, gris

L 1080, B 280, H 1100



E27 3x 28W



9 002759 995126

99511 ABREOSA

pendant light; steel, black, grey
Hängeleuchte; Stahl, schwarz, grau
luminaire en suspension; acier, noir, gris

H 1100, Ø 280



E27 1x 28W

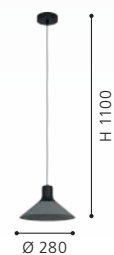

9 002759 995119



99511





900907



900907

This wall lamps have an on/off switch on the baldachin.

Diese Wandleuchten verfügen über einen ein/aus-Schalter am Baldachin.

Ces appliques disposent d'un interrupteur marche/arrêt sur le baldachin.



900909



900908



900907 ALMUDAINA

wall light; steel, black
Wandleuchte; Stahl, schwarz
Applique; acier, noir

L 110, H 200, A 200



1x 5W



480lm



900909 ALMUDAINA

floor light; steel, black
Stehleuchte; Stahl, schwarz
lampadaire; acier, noir

H 1570, Base: Ø 270



1x 5W



480lm



900908 ALMUDAINA

table light; steel, black
Tischleuchte; Stahl, schwarz
luminaire de table; acier, noir

H 495, Base: Ø 170



1x 5W



480lm



9 008606 274116



9 008606 274130



9 008606 274123



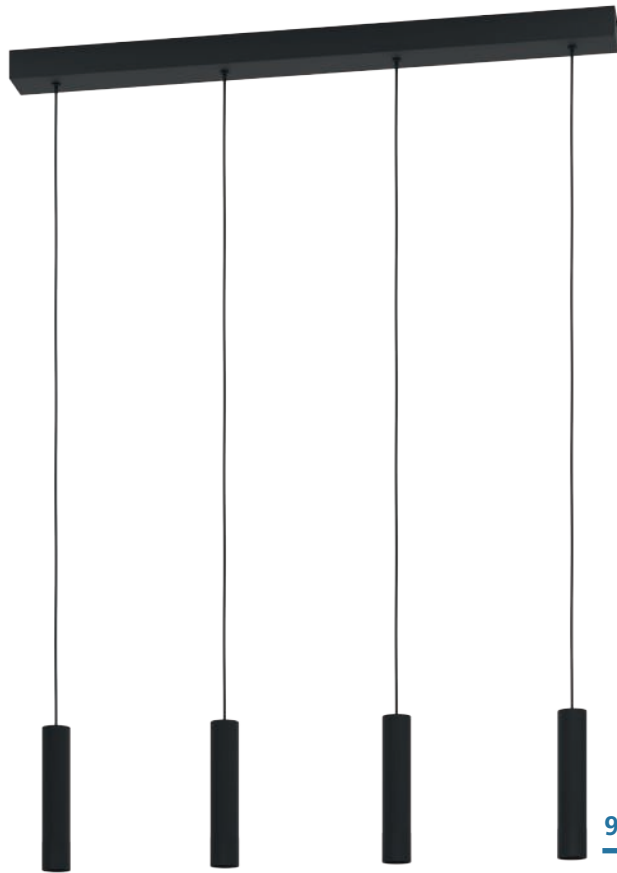

900906

LED



900926

LED

900906 ALMUDAINA

pendant light; steel, black
Hängeleuchte; Stahl, schwarz
luminaire en suspension; acier, noir

L 840, B 60, H 1100

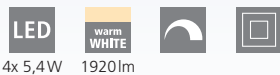

4x 5,4W 1920lm



9 008606 274109

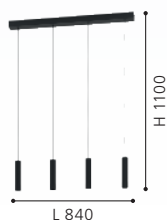

900926 ALMUDAINA

pendant light; steel, black
Hängeleuchte; Stahl, schwarz
luminaire en suspension; acier, noir

H 1100, Ø 40



1x 5W 480lm



9 008606 281817



ALMUDAINA

The heads of the wall lamp, table lamp and the floor lamp of the Almudaina series can be swiveled to the right and left as well as, down and up.

Die Köpfe der Wandleuchte, Tischleuchte und der Stehleuchte der Serie Almudaina lassen sich nach rechts und links sowie, nach unten und nach oben schwenken.

Les têtes de la lampe murale, les lumières de la table et la lampe à l'ordre de la série Almudaina peuvent être pivotés à droite et à gauche ainsi que, en bas et en haut.





99551



99552



99553

99551 CASIBARE

pendant light; steel, black
Hängeleuchte; Stahl, schwarz
luminaire en suspension; acier, noir

H 1100, Ø 150



E27 1x 40W



9 002759 995515



99552 CASIBARE

pendant light; steel, black
Hängeleuchte; Stahl, schwarz
luminaire en suspension; acier, noir

L 850, B 150, H 1100



E27 3x 40W



9 002759 995522

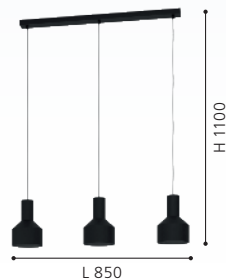

99553 CASIBARE

pendant light; steel, black
Hängeleuchte; Stahl, schwarz
luminaire en suspension; acier, noir

H 1500, Ø 710



E27 5x 40W



9 002759 995539





99554



99555

99554 CASIBARE

table light; steel, black
Tischleuchte; Stahl, schwarz
luminaire de table; acier, noir

L 160, B 120, H 490, Base: Ø 155



E27 1x 28W



9 002759 995546



99555 CASIBARE

floor light; steel, black
Stehleuchte; Stahl, schwarz
lampadaire; acier, noir

L 350, B 120, H 1605, Base: Ø 250

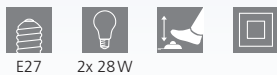

E27 2x 28W



9 002759 995553





99345



900164

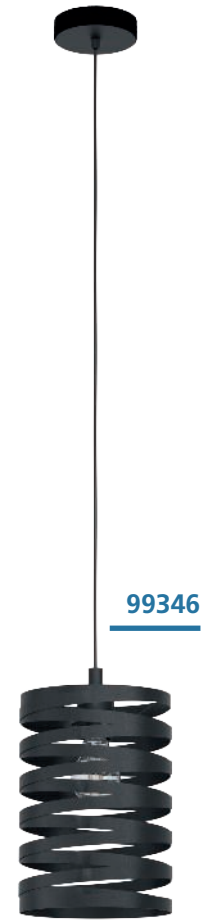

99346

99345 CREMELLA

pendant light; steel, black
Hängeleuchte; Stahl, schwarz
luminaire en suspension; acier, noir

H 1100, Ø 370



900164 CREMELLA

ceiling light; steel, black
Deckenleuchte; Stahl, schwarz
plafonnier; acier, noir

H 260, Ø 370

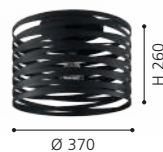

99346 CREMELLA

pendant light; steel, black
Hängeleuchte; Stahl, schwarz
luminaire en suspension; acier, noir

H 1100, Ø 180





99347



99506



99507

99347 CREMELLA

pendant light; steel, black
Hängeleuchte; Stahl, schwarz
luminaire en suspension; acier, noir

L 940, B 180, H 1100



E27 3x 40W



9 002759 993474

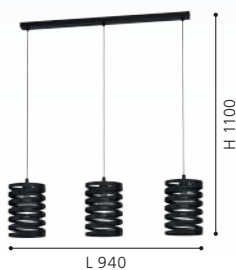

99506 CREMELLA

table light; steel, black
Tischleuchte; Stahl, schwarz
luminaire de table; acier, noir

H 290, Ø 180, Base: Ø 180

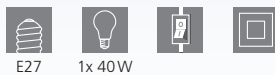

E27 1x 40W



9 002759 995065



99507 CREMELLA

floor light; steel, black
Stehleuchte; Stahl, schwarz
lampadaire; acier, noir

H 1510, Ø 370, Base: Ø 250

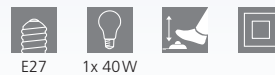

E27 1x 40W



9 002759 995072

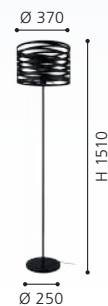



900494

900495

900494 ROMAZZINA

pendant light; steel, black
 Hängeleuchte; Stahl, schwarz
 luminaire en suspension; acier, noir

H 1100, Ø 325



900495 ROMAZZINA

pendant light; steel, black
 Hängeleuchte; Stahl, schwarz
 luminaire en suspension; acier, noir

L 900, B 200, H 1100





900686



900495 | 900519 | 900686



900494 | 900522



900519



900522

900686 ROMAZZINA

pendant light; steel, black
Hängeleuchte; Stahl, schwarz
luminaire en suspension; acier, noir

H 1100, Ø 460



900519 ROMAZZINA

table light; steel, black
Tischleuchte; Stahl, schwarz
luminaire de table; acier, noir

H 435, Ø 200, Base: Ø 225

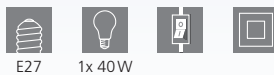

900522 ROMAZZINA

floor light; steel, black
Stehleuchte; Stahl, schwarz
lampadaire; acier, noir

H 1405, Ø 325, Base: Ø 630

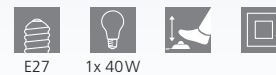



900687



900496



DESIGN
HIGHLIGHT
DETAIL

900687 ROMAZZINA

pendant light; steel, sandy
Hängeleuchte; Stahl, sandfarben
luminaire en suspension; acier, couleur sable

H 1100, Ø 460



9 008606 258574



900496 ROMAZZINA

pendant light; steel, sandy
Hängeleuchte; Stahl, sandfarben
luminaire en suspension; acier, couleur sable

H 1100, Ø 325



9 008606 244300





900497



900497 | 900521 | 900687



900496 | 900523



900521



900523

900497 ROMAZZINA

pendant light; steel, sandy
Hängeleuchte; Stahl, sandfarben
luminaire en suspension; acier, couleur sable

L 900, B 200, H 1100



E27 3x 40W



9 008606 244317



900521 ROMAZZINA

table light; steel, sandy
Tischleuchte; Stahl, sandfarben
luminaire de table; acier, couleur sable

H 435, Ø 200, Base: Ø 225

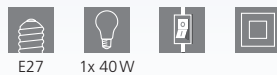

E27 1x 40W



9 008606 244492



900523 ROMAZZINA

floor light; steel, sandy
Stehleuchte; Stahl, sandfarben
lampadaire; acier, couleur sable

H 1405, Ø 325, Base: Ø 630

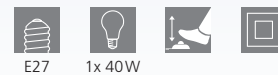

E27 1x 40W



9 008606 244515





900165 VENEZUELA

ceiling light; steel, black, gold
 Deckenleuchte; Stahl, schwarz, gold
 plafonnier; acier, noir, or

H 250, Ø 385



900166 VENEZUELA

pendant light; steel, black, gold
 Hängeleuchte; Stahl, schwarz, gold
 luminaire en suspension; acier, noir, or

H 1100, Ø 235



900167 VENEZUELA

pendant light; steel, black, gold
 Hängeleuchte; Stahl, schwarz, gold
 luminaire en suspension; acier, noir, or

L 935, B 235, H 1100





900168

900168 VENEZUELA

table light; steel, black, gold
Tischleuchte; Stahl, schwarz, gold
luminaire de table; acier, noir, or

H 225, Ø 235, Base: Ø 115



E27



1x 40W

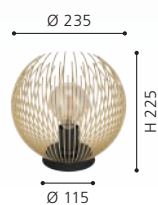



99806



99807

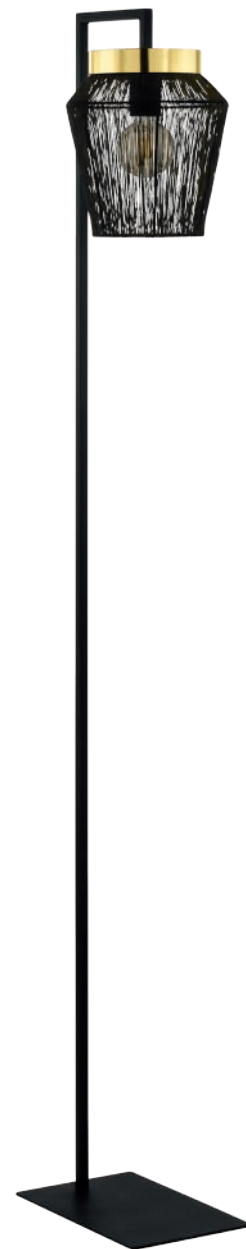

99809

99806 ESCANDIDOS

pendant light; steel, black, brass / steel, black, gold
 Hängeleuchte; Stahl, schwarz, messing / Stahl, schwarz, gold
 luminaire en suspension; acier, noir, laiton / acier, noir, or

H 1100, Ø 220

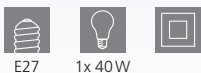

E27 1x 40W



9 002759 998066



99807 ESCANDIDOS

pendant light; steel, black, brass / steel, black, gold
 Hängeleuchte; Stahl, schwarz, messing / Stahl, schwarz, gold
 luminaire en suspension; acier, noir, laiton / acier, noir, or

L 920, B 220, H 1100



E27 3x 40W



9 002759 998073



99809 ESCANDIDOS

floor light; steel, black, brass / steel, black, gold
 Stehleuchte; Stahl, schwarz, messing / Stahl, schwarz, gold
 lampadaire; acier, noir, laiton / acier, noir, or

L 310, B 220, H 1700, Base: B 300, T 200

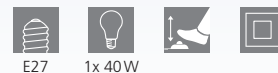

E27 1x 40W



9 002759 998097





99808

99808 ESCANDIDOS

table light; steel, black, brass / steel, black, gold
Tischleuchte; Stahl, schwarz, messing / Stahl, schwarz, gold
luminaire de table; acier, noir, laiton / acier, noir, or

H 260, Ø 220, Base: Ø 150





900177



900177 LURONE

pendant light; steel, black, brass
Hängeleuchte; Stahl, schwarz, messing
luminaire en suspension; acier, noir, laiton

L 1000, B 50, H 1100



E27



4x 10W



9 008606 241132

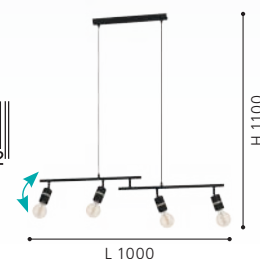



900176 LURONE

ceiling light; steel, black, brass
Deckenleuchte; Stahl, schwarz, messing
plafonnier; acier, noir, laiton

L 1000, B 50, H 270

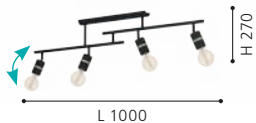

900178 LURONE

table light; steel, black, brass
Tischleuchte; Stahl, schwarz, messing
luminaire de table; acier, noir, laiton

L 205, B 50, H 500, Base: Ø 200



900179 LURONE

floor light; steel, black, brass
Stehleuchte; Stahl, schwarz, messing
lampadaire; acier, noir, laiton

L 205, B 50, H 1600, Base: Ø 250

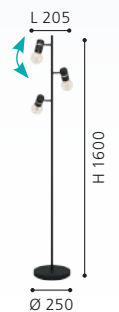
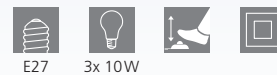



900731



900732

900731 ESCANDELL

pendant light; steel, black, brushed brass
 Hängeleuchte; Stahl, schwarz, messing-gebürstet
 luminaire en suspension; acier, noir, laiton brossé

H 1100, Ø 250



9 008606 273874



900732 ESCANDELL

pendant light; steel, black, brushed brass
 Hängeleuchte; Stahl, schwarz, messing-gebürstet
 luminaire en suspension; acier, noir, laiton brossé

L 950, B 250, H 1100



9 008606 273881

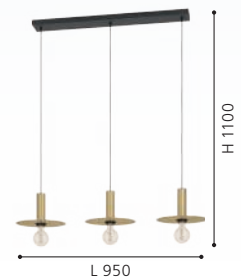

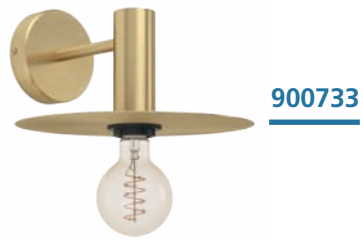

ESCANDELL

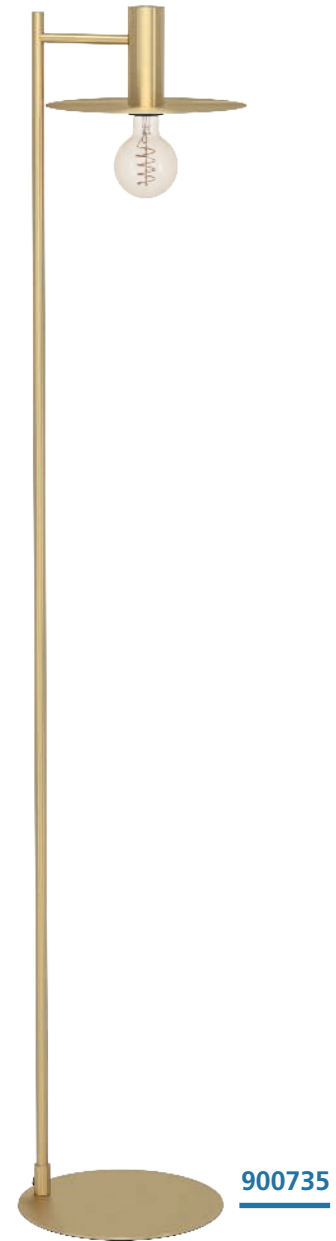

900733 ESCANDELL

wall light; steel, brushed brass
Wandleuchte; Stahl, messing-gebürstet
Applique; acier, laiton brossé

L 250, H 120, A 270

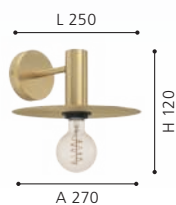

900734 ESCANDELL

table light; steel, brushed brass
Tischleuchte; Stahl, messing-gebürstet
luminaire de table; acier, laiton brossé

L 220, B 230, H 470, Base: Ø 220

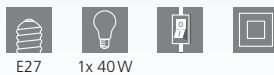

900735 ESCANDELL

floor light; steel, brushed brass
Stehleuchte; Stahl, messing-gebürstet
lampadaire; acier, laiton brossé

L 270, B 250, H 1560, Base: Ø 270

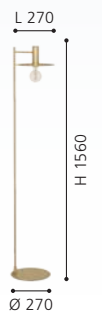
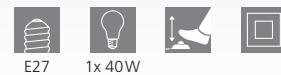



900843

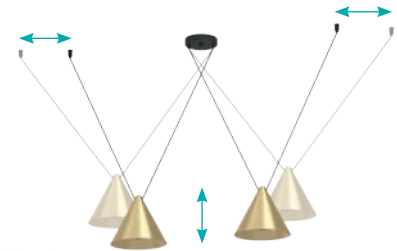

900843

These luminaires can be mounted wider or narrower according to the customer's requirements due to the mounting knobs.

Diese Leuchten können aufgrund der Befestigungsknöpfe je nach Kundenwunsch weiter oder enger montiert werden.

Grâce aux boutons de fixation, ces luminaires peuvent être montés plus ou moins loin, selon les souhaits du client.



99593

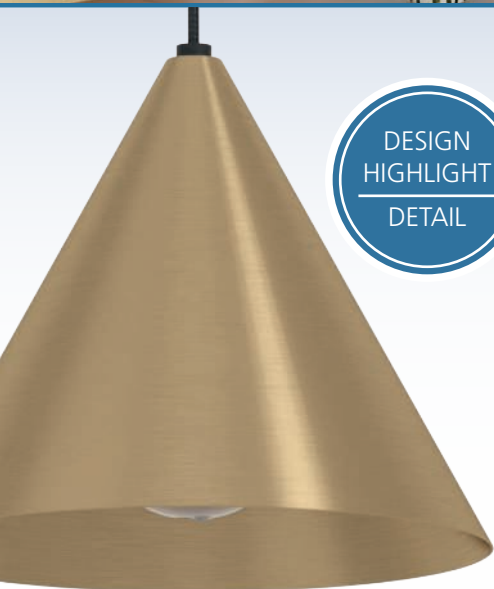

DESIGN
HIGHLIGHT
DETAIL

900843 NARICES 1

pendant light; steel, black / steel, brushed brass, gold
Hängeleuchte; Stahl, schwarz / Stahl, messing-gebürstet, gold
luminaire en suspension; acier, noir / acier, laiton brossé, or

L 1730, B 260, H 1100

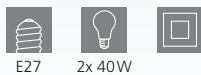

E27 2x 40W



9 008606 270286

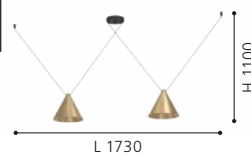

99593 NARICES

table light; steel, black / steel, brushed brass, gold
Tischleuchte; Stahl, schwarz / Stahl, messing-gebürstet, gold
luminaire de table; acier, noir / acier, laiton brossé, or

L 295, B 220, H 500, Base: Ø 220

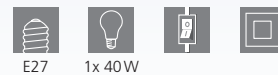

E27 1x 40W



9 002759 995935

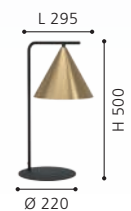



99592 NARICES

pendant light; steel, black / steel, brushed brass, gold
 Hängeleuchte; Stahl, schwarz / Stahl, messing-gebürstet, gold
 luminaire en suspension; acier, noir / acier, laiton brossé, or

L 920, B 220, H 1100

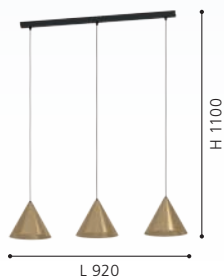

99591 NARICES

pendant light; steel, black / steel, brushed brass, gold
 Hängeleuchte; Stahl, schwarz / Stahl, messing-gebürstet, gold
 luminaire en suspension; acier, noir / acier, laiton brossé, or

H 1100, Ø 220

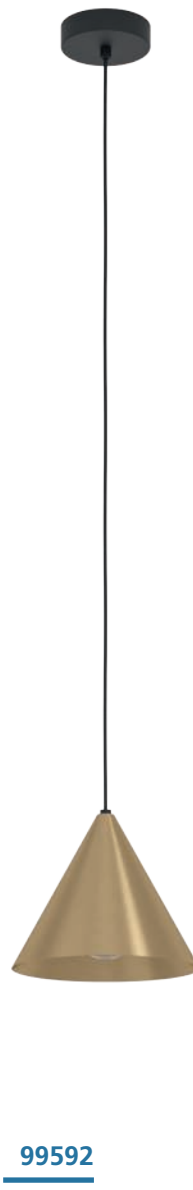
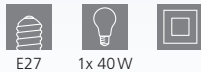

99592



99594 NARICES

floor light; steel, black / steel, brushed brass, gold
 Stehleuchte; Stahl, schwarz / Stahl, messing-gebürstet, gold
 lampadaire; acier, noir / acier, laiton brossé, or

L 295, B 220, H 1620, Base: Ø 270



99594

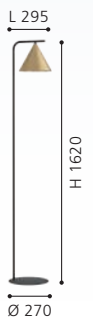



900873

LED



900872

LED

900873 BARBOTTO

pendant light; steel, black, gold
 Hängeleuchte; Stahl, schwarz, gold
 luminaire en suspension; acier, noir, or

L 925, B 60, H 1100



GU10



4x 4,5W



4x

345lm

warm
WHITE



9 008606 270309



900872 BARBOTTO

pendant light; steel, black, gold
 Hängeleuchte; Stahl, schwarz, gold
 luminaire en suspension; acier, noir, or

H 1100, Ø 60



GU10



1x 4,5W



1x

345lm

warm
WHITE



9 008606 270293

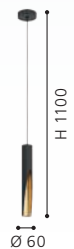



97583

LED

97584

LED

97583 BARBOTTO

table light; steel, black, gold
Tischleuchte; Stahl, schwarz, gold
luminaire de table; acier, noir, or

H 395, Ø 60, Base: Ø 100

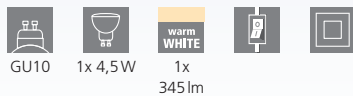

GU10 1x 4,5W 1x warm WHITE 345lm



9 002759 975838



97584 BARBOTTO

floor light; steel, black, gold
Stehleuchte; Stahl, schwarz, gold
lampadaire; acier, noir, or

H 1370, Ø 60, Base: Ø 185



GU10 1x 4,5W 1x warm WHITE 345lm



9 002759 975845





900875



900876



900875 BARBOTTO

pendant light; steel, wood, black, brown
 Hängeleuchte; Stahl, Holz, schwarz, braun
 luminaire en suspension; acier, bois, noir, marron

L 925, B 60, H 1100

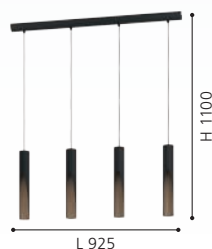
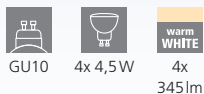

900876 BARBOTTO

table light; steel, wood, black, brown
 Tischleuchte; Stahl, Holz, schwarz, braun
 luminaire de table; acier, bois, noir, marron

H 395, Ø 60, Base: Ø 100

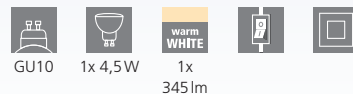



900877

LED



900874

LED

900877 BARBOTTO

floor light; steel, wood, black, brown
 Stehleuchte; Stahl, Holz, schwarz, braun
 lampadaire; acier, bois, noir, marron

H 1365, Ø 60, Base: Ø 185

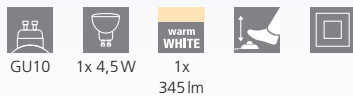

GU10 1x 4,5W 1x warm WHITE 345lm



9 008606 270347



900874 BARBOTTO

pendant light; steel, wood, black, brown
 Hängeleuchte; Stahl, Holz, schwarz, braun
 luminaire en suspension; acier, bois, noir, marron

H 1100, Ø 60

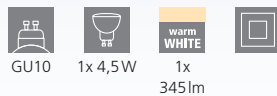

GU10 1x 4,5W 1x warm WHITE 345lm



9 008606 270316





99098



99097



99096

99098 ERSEKA

pendant light; steel, brass / brilliant glass, clear
 Hängeleuchte; Stahl, messing / Brillantglas, klar
 luminaire en suspension; acier, laiton / verre brillant, transparent

H 1300, Ø 385



9 002759 990985



99097 ERSEKA

pendant light; steel, brass / brilliant glass, clear
 Hängeleuchte; Stahl, messing / Brillantglas, klar
 luminaire en suspension; acier, laiton / verre brillant, transparent

H 1450, Ø 485

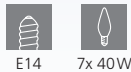

9 002759 990978



99096 ERSEKA

ceiling light; steel, brass / brilliant glass, clear
 Deckenleuchte; Stahl, messing / Brillantglas, klar
 plafonnier; acier, laiton / verre brillant, transparent

H 535, Ø 485



9 002759 990961

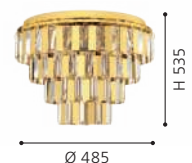



99095



99094



99093



EGLO
RECOMMENDS
110025

ERSEKA

99095 ERSEKA

pendant light; steel, chrome / brilliant glass, clear
Hängeleuchte; Stahl, chrom / Brillantglas, klar
luminaire en suspension; acier, chrome / verre brillant, transparent

H 1300, Ø 385



E14 5x 40W



9 002759 990954



99094 ERSEKA

pendant light; steel, chrome / brilliant glass, clear
Hängeleuchte; Stahl, chrom / Brillantglas, klar
luminaire en suspension; acier, chrome / verre brillant, transparent

H 1450, Ø 485



E14 7x 40W



9 002759 990947



99093 ERSEKA

ceiling light; steel, chrome / brilliant glass, clear
Deckenleuchte; Stahl, chrom / Brillantglas, klar
plafonnier; acier, chrome / verre brillant, transparent

H 535, Ø 485



E14 7x 40W



9 002759 990930





900305



MANZANARES

900305 MANZANARES

pendant light; steel, brushed brass, gold / matte-opal glass, white

Hängeleuchte; Stahl, messing-gebürstet, gold / Glas opal-matt, weiss

luminaire en suspension; acier, laiton brossé, or / verre opale mat, blanc

H 1100, Ø 225



E27



1x 40W



9 008606 235902

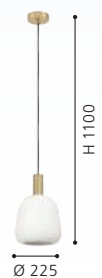



900306 MANZANARES

pendant light; steel, brushed brass, gold / matte-opal glass, white

Hängeleuchte; Stahl, messing-gebürstet, gold / Glas opal-matt, weiss

luminaire en suspension; acier, laiton brossé, or / verre opale mat, blanc

L 970, B 145, H 1100



E27 4x 40W



9 008606 235919

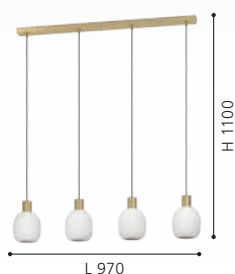

900304 MANZANARES

ceiling light; steel, brushed brass, gold / matte-opal glass, white

Deckenleuchte; Stahl, messing-gebürstet, gold / Glas opal-matt, weiss

plafonnier; acier, laiton brossé, or / verre opale mat, blanc

H 190, Ø 450



E27 3x 40W



9 008606 235896

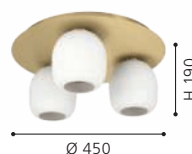

900307 MANZANARES

table light; steel, brushed brass, gold / matte-opal glass, white

Tischleuchte; Stahl, messing-gebürstet, gold / Glas opal-matt, weiss

luminaire de table; acier, laiton brossé, or / verre opale mat, blanc

H 180, Ø 145, Base: Ø 90

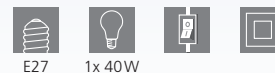

E27 1x 40W



9 008606 235926





85261



85262

85261 RONDO

pendant light; steel, satin nickel / matte-opal glass, white
 Hängeleuchte; Stahl, nickel-matt / Glas opal-matt, weiss
 luminaire en suspension; acier, nickel mat / verre opale mat, blanc

H 1100, Ø 200



85262 RONDO

pendant light; steel, satin nickel / matte-opal glass, white
 Hängeleuchte; Stahl, nickel-matt / Glas opal-matt, weiss
 luminaire en suspension; acier, nickel mat / verre opale mat, blanc

H 1100, Ø 250

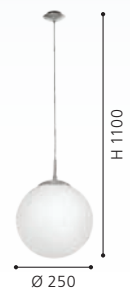



85263 RONDO

pendant light; steel, satin nickel / matte-opal glass, white
Hängeleuchte; Stahl, nickel-matt / Glas opal-matt, weiss
luminaire en suspension; acier, nickel mat / verre opale mat, blanc

H 1100, Ø 300



91589 RONDO

ceiling light; steel, satin nickel / matte-opal glass, white
Deckenleuchte; Stahl, nickel-matt / Glas opal-matt, weiss
plafonnier; acier, nickel mat / verre opale mat, blanc

H 315, Ø 250

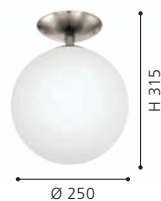

85264 RONDO

table light; plastic, white / matte-opal glass, white
Tischleuchte; Kunststoff, weiss / Glas opal-matt, weiss
luminaire de table; plastique, blanc / verre opale mat, blanc

H 200, Ø 200

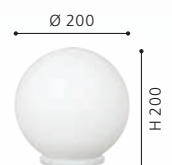
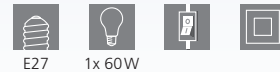



900395



900511

900512

The flower pots are included in these luminaires.

Bei diesen Leuchten sind die Blumentöpfe inkludiert.

Les pots de fleurs sont inclus dans ces luminaires.

900395 RONDO

pendant light; steel, satin nickel / matte-opal glass, white
 Hängeleuchte; Stahl, nickel-matt / Glas opal-matt, weiss
 luminaire en suspension; acier, nickel mat / verre opale mat, blanc

L 960, B 200, H 1100



E27

3x 40W



9 008606 239467

900511 RONDO 3

pendant light; steel, black / matte-opal glass, white
 Hängeleuchte; Stahl, schwarz / Glas opal-matt, weiss
 luminaire en suspension; acier, noir / verre opale mat, blanc

H 1100, Ø 300



E27

1x 40W



9 008606 244409

900512 RONDO 3

pendant light; steel, black / matte-opal glass, white
 Hängeleuchte; Stahl, schwarz / Glas opal-matt, weiss
 luminaire en suspension; acier, noir / verre opale mat, blanc

L 1210, B 200, H 1100



E27

3x 40W

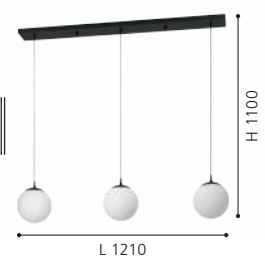

9 008606 244416



900512



86817



86817 OPTICA

floor light; steel, satin nickel / matte-opal glass, white
Stehleuchte; Stahl, nickel-matt / Glas opal-matt, weiss
lampadaire; acier, nickel mat / verre opale mat, blanc

H 1570, Ø 350



E27



2x 60W

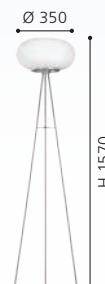



86811



86812

86811 OPTICA

wall/ceiling light; steel, satin nickel / matte-opal glass, white
Wand- / Deckenleuchte; Stahl, nickel-matt / Glas opal-matt, weiss
Applique/Plafonnier; acier, nickel mat / verre opale mat, blanc

H 160, Ø 280



E27 2x 60W

86812 OPTICA

wall/ceiling light; steel, satin nickel / matte-opal glass, white
Wand- / Deckenleuchte; Stahl, nickel-matt / Glas opal-matt, weiss
Applique/Plafonnier; acier, nickel mat / verre opale mat, blanc

H 210, Ø 350



E27 2x 60W



9 002759 868116

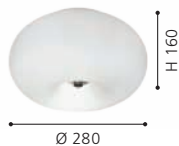

9 002759 868123

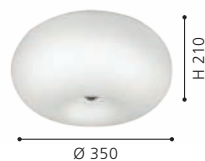

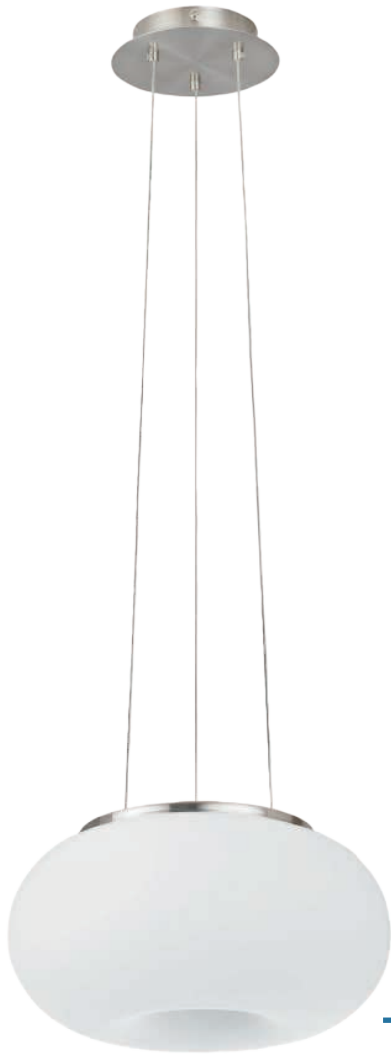

86813



86814



86813 OPTICA

pendant light; steel, satin nickel / matte-opal glass, white
 Hängeleuchte; Stahl, nickel-matt / Glas opal-matt, weiss
 luminaire en suspension; acier, nickel mat / verre opale mat, blanc

H 1100, Ø 280



86814 OPTICA

pendant light; steel, satin nickel / matte-opal glass, white
 Hängeleuchte; Stahl, nickel-matt / Glas opal-matt, weiss
 luminaire en suspension; acier, nickel mat / verre opale mat, blanc

H 1100, Ø 350



86815 OPTICA

pendant light; steel, satin nickel / matte-opal glass, white
 Hängeleuchte; Stahl, nickel-matt / Glas opal-matt, weiss
 luminaire en suspension; acier, nickel mat / verre opale mat, blanc

H 1100, Ø 445

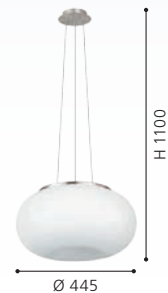



86815



99631



99632



DESIGN
HIGHLIGHT
DETAIL



33984

99631 GOROSIBA 1

ceiling light; steel, black / glass vaporized, black-transparent
Deckenleuchte; Stahl, schwarz / Glas bedampft, schwarz-transparent
plafonnier; acier, noir / verre vaporisé, noir transparent

H 175, Ø 450



E27 3x 40W

99632 GOROSIBA 1

ceiling light; steel, black / glass vaporized, black-transparent
Deckenleuchte; Stahl, schwarz / Glas bedampft, schwarz-transparent
plafonnier; acier, noir / verre vaporisé, noir transparent

L 380, B 380, H 170



E27 4x 40W

33984 GOROSIBA

table light; steel, black / glass vaporized, black-transparent
Tischleuchte; Stahl, schwarz / Glas bedampft, schwarz-transparent
luminaire de table; acier, noir / verre vaporisé, noir transparent

H 220, Ø 150, Base: Ø 100



E27 1x 60W



9 002759 996314



9 002759 996321



9 002759 339845





98752



98752



98753



98753 | 98754



98754

98752 GOROSIBA

pendant light; steel, black / glass vaporized, black-transparent
Hängeleuchte; Stahl, schwarz / Glas bedampft, schwarz-transparent

luminaire en suspension; acier, noir / verre vaporisé, noir transparent

H 1100, Ø 150

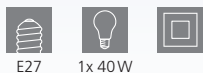

9 002759 987527



98753 GOROSIBA

pendant light; steel, black / glass vaporized, black-transparent
Hängeleuchte; Stahl, schwarz / Glas bedampft, schwarz-transparent

luminaire en suspension; acier, noir / verre vaporisé, noir transparent

L 850, B 150, H 1100



9 002759 987534

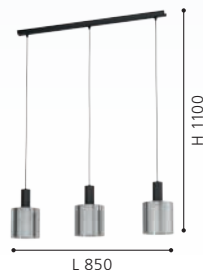

98754 GOROSIBA

pendant light; steel, black / glass vaporized, black-transparent
Hängeleuchte; Stahl, schwarz / Glas bedampft, schwarz-transparent

luminaire en suspension; acier, noir / verre vaporisé, noir transparent

H 1300, Ø 410



9 002759 987541





900341



900342



900341 PINTO TEXTIL 1

pendant light; steel, black / glass, fabric, clear, black
 Hängeleuchte; Stahl, schwarz / Glas, Textil, klar, schwarz
 luminaire en suspension; acier, noir / verre, tissu, transparent, noir

H 1100, Ø 120



900342 PINTO TEXTIL 1

pendant light; steel, black / glass, fabric, clear, black
 Hängeleuchte; Stahl, schwarz / Glas, Textil, klar, schwarz
 luminaire en suspension; acier, noir / verre, tissu, transparent, noir

L 820, B 120, H 1100





99286 | 99287



99288



99286 PINTO TEXTIL

pendant light; steel, satin nickel / glass, fabric, clear, grey
Hängeleuchte; Stahl, nickel-matt / Glas, Textil, klar, grau
luminaire en suspension; acier, nickel mat / verre, tissu, transparent, gris

L 820, B 120, H 1100

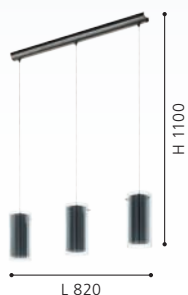

99287 PINTO TEXTIL

pendant light; steel, satin nickel / glass, fabric, clear, grey
Hängeleuchte; Stahl, nickel-matt / Glas, Textil, klar, grau
luminaire en suspension; acier, nickel mat / verre, tissu, transparent, gris

L 945, B 120, H 1100

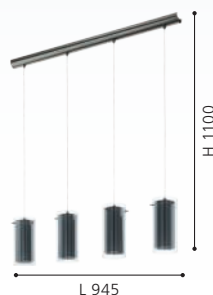

99288 PINTO TEXTIL

wall light; steel, satin nickel / glass, fabric, clear, grey
Wandleuchte; Stahl, nickel-matt / Glas, Textil, klar, grau
Applique; acier, nickel mat / verre, tissu, transparent, gris

L 120, H 445, A 180





DESIGN
HIGHLIGHT
DETAIL



90304



PINTO NERO

90304 PINTO NERO

pendant light; steel, satin nickel / smoked glass, matte-opal glass, black-transparent, white

Hängeleuchte; Stahl, nickel-matt / Rauchglas, Glas opal-matt, schwarz-transparent, weiss

luminaire en suspension; acier, nickel mat / verre fumé, verre opale mat, noir transparent, blanc

H 1100, Ø 110



E27



1x 40W



9 002759 903046



90305 PINTO NERO

pendant light; steel, satin nickel / smoked glass, matte-opal glass, black-transparent, white

Hängeleuchte; Stahl, nickel-matt / Rauchglas, Glas opal-matt, schwarz-transparent, weiss

luminaire en suspension; acier, nickel mat / verre fumé, verre opale mat, noir transparent, blanc

L 725, H 1100



E27



3x 40W



9 002759 903053

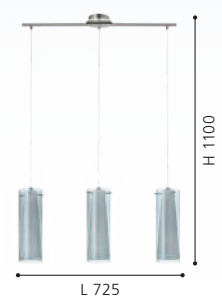



90305



97653



97651



97839

97653 PINTO GOLD

pendant light; steel, black / glass, clear, gold
 Hängeleuchte; Stahl, schwarz / Glas, klar, gold
 luminaire en suspension; acier, noir / verre, transparent, or

L 905, B 360, H 1100



E27



4x 40W



9 002759 976538

97651 PINTO GOLD

pendant light; steel, black / glass, clear, gold
 Hängeleuchte; Stahl, schwarz / Glas, klar, gold
 luminaire en suspension; acier, noir / verre, transparent, or

H 1100, Ø 110



E27



1x 40W

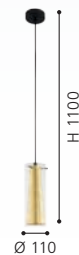

9 002759 976514

97839 PINTO GOLD

wall light; steel, black / glass, clear, gold
 Wandleuchte; Stahl, schwarz / Glas, klar, gold
 Applique; acier, noir / verre, transparent, or

L 110, H 270, A 150



E27



1x 40W

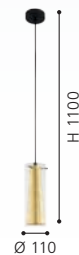

9 002759 978396



97652



97655



PINTO GOLD



97652 PINTO GOLD

pendant light; steel, black / glass, clear, gold
 Hängeleuchte; Stahl, schwarz / Glas, klar, gold
 luminaire en suspension; acier, noir / verre, transparent, or

L 725, B 110, H 1100

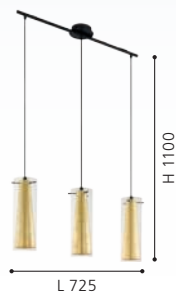

97655 PINTO GOLD

floor light; steel, black, gold / glass, clear, gold
 Stehleuchte; Stahl, schwarz, gold / Glas, klar, gold
 lampadaire; acier, noir, or / verre, transparent, or

H 1470, Ø 110, Base: Ø 230

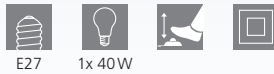

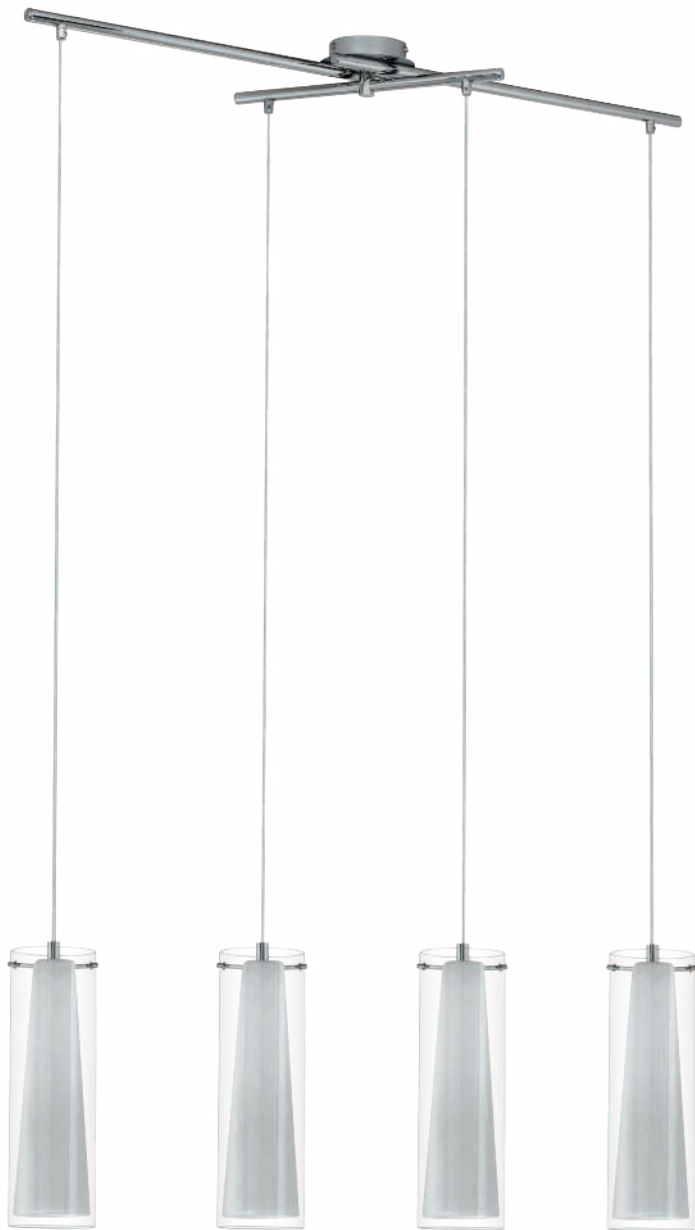

89832 | 89833 | 89834 |
89835 | 89836



89832

89834

89835

89834 PINTO

pendant light; steel, chrome / glass, matte-opal glass, clear, white
Hängeleuchte; Stahl, chrom / Glas, Glas opal-matt, klar, weiss
luminaire en suspension; acier, chrome / verre, verre opale mat, transparent, blanc

L 905, B 360, H 1100



E27 4x 40W



9 002759 898342

89835 PINTO

table light; steel, chrome / glass, matte-opal glass, clear, white
Tischleuchte; Stahl, chrom / Glas, Glas opal-matt, klar, weiss
luminaire de table; acier, chrome / verre, verre opale mat, transparent, blanc

H 500, Ø 110, Base: Ø 155



E27 1x 40W



9 002759 898359

89832 PINTO

pendant light; steel, chrome / glass, matte-opal glass, clear, white
Hängeleuchte; Stahl, chrom / Glas, Glas opal-matt, klar, weiss
luminaire en suspension; acier, chrome / verre, verre opale mat, transparent, blanc

H 1100, Ø 110



E27 1x 40W

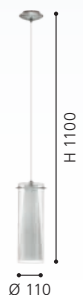

9 002759 898328



93003



89833



89836

93003 PINTO

pendant light; steel, chrome / glass, matte-opal glass, clear, white

Hängeleuchte; Stahl, chrom / Glas, Glas opal-matt, klar, weiss
luminaire en suspension; acier, chrome / verre, verre opale mat, transparent, blanc

H 1500, Ø 500



E27 5x 40W



9 002759 930035

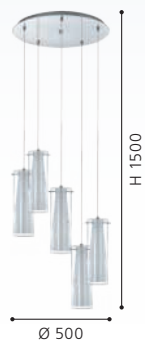

89833 PINTO

pendant light; steel, chrome / glass, matte-opal glass, clear, white

Hängeleuchte; Stahl, chrom / Glas, Glas opal-matt, klar, weiss
luminaire en suspension; acier, chrome / verre, verre opale mat, transparent, blanc

L 725, H 1100



E27 3x 40W



9 002759 898335



89836 PINTO

floor light; steel, chrome / glass, matte-opal glass, clear, white

Stehleuchte; Stahl, chrom / Glas, Glas opal-matt, klar, weiss
lampadaire; acier, chrome / verre, verre opale mat, transparent, blanc

H 1470, Ø 110, Base: Ø 230

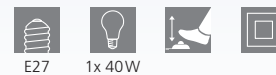

E27 1x 40W



9 002759 898366





85978



85977

85978 TROY 3

pendant light; steel, satin nickel / satin glass, white painted
Hängeleuchte; Stahl, nickel-matt / Glas satiniert, weiss lackiert
luminaire en suspension; acier, nickel mat / verre satiné, blanc laqué

L 720, B 105, H 1100



E27



3x 40W



9 002759 859787

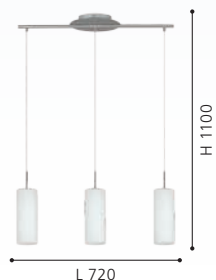

85977 TROY 3

pendant light; steel, satin nickel / satin glass, white painted
Hängeleuchte; Stahl, nickel-matt / Glas satiniert, weiss lackiert
luminaire en suspension; acier, nickel mat / verre satiné, blanc laqué

H 1100, Ø 110



E27



1x 40W



9 002759 859770



85979 TROY 3

wall light; steel, satin nickel / satin glass, white
Wandleuchte; Stahl, nickel-matt / Glas satiniert, weiss
Applique; acier, nickel mat / verre satiné, blanc laqué

L 180, H 250, A 75



E14



1x 60W



9 002759 859794





85979



85979



85981



85977 | 85978 | 85981 |
85982

85981 TROY 3

table light; steel, satin nickel / satin glass, white painted
Tischleuchte; Stahl, nickel-matt / Glas satiniert, weiss lackiert
luminaire de table; acier, nickel mat / verre satiné, blanc laqué

H 460, Ø 105, Base: Ø 120



E27 1x 40W



9 002759 859817



85982 TROY 3

floor light; steel, satin nickel / satin glass, white painted
Stehleuchte; Stahl, nickel-matt / Glas satiniert, weiss lackiert
lampadaire; acier, nickel mat / verre satiné, blanc laqué

H 1530, Ø 105, Base: Ø 200



E27 1x 40W



9 002759 859824



85982



92741



92742



92742



92743

92741 RIVATO

pendant light; steel, chrome / glass with decoration, white, chrome
 Hängeleuchte; Stahl, chrom / Glas mit Dekor, weiss, chrom
 luminaire en suspension; acier, chrome / verre avec décor, blanc, chrome

L 705, B 90, H 1100



E27 3x 60W



9 002759 927417

92742 RIVATO

wall light; steel, white, chrome / glass with decoration, white, chrome
 Wandleuchte; Stahl, weiss, chrom / Glas mit Dekor, weiss, chrom
 Applique; acier, blanc, chrome / verre avec décor, blanc, chrome

L 180, H 250, A 80



E14 1x 42W



9 002759 927424

92743 RIVATO

table light; glass, plastic, white, chrome
 Tischleuchte; Glas, Kunststoff, weiss, chrom
 luminaire de table; verre, plastique, blanc, chrome

H 260, Ø 90

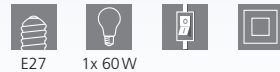

E27 1x 60W



9 002759 927431



92563



92741 | 92743
91971 | 92563



91971

92563 BAYMAN

pendant light; steel, chrome / glass, white, chrome
Hängeleuchte; Stahl, chrom / Glas, weiss, chrom
luminaire en suspension; acier, chrome / verre, blanc, chrome

L 720, B 105, H 1100



91971 BAYMAN

table light; glass, plastic, white, chrome
Tischleuchte; Glas, Kunststoff, weiss, chrom
luminaire de table; verre, plastique, blanc, chrome

H 270, Ø 105

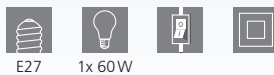



91433



91004

91433 VINOVO

pendant light; steel, dark brown / alabaster glass, white
 Hängeleuchte; Stahl, dunkelbraun / Glas alabaster, weiss
 luminaire en suspension; acier, marron foncé / verre albâtre, blanc

L 770, B 250, H 1100



E27



2x 60W



9 002759 914332



91004 MURCIA

pendant light; steel, black / alabaster glass, white
 Hängeleuchte; Stahl, schwarz / Glas alabaster, weiss
 luminaire en suspension; acier, noir / verre albâtre, blanc

L 680, H 1100



E27



2x 60W



9 002759 910044

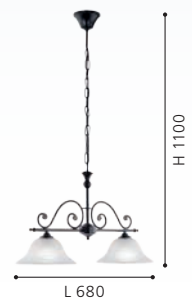



MURCIA, VINOVO

These luminaires come with high quality processed alabaster glass.

Diese Leuchten sind mit hochwertigem Alabasterglas ausgestattet.

Ces luminaires viennent avec un abat-jour en verre d'albâtre haut de gamme.

91002 MURCIA

pendant light; steel, black / alabaster glass, white
Hängeleuchte; Stahl, schwarz / Glas alabaster, weiss
luminaire en suspension; acier, noir / verre albâtre, blanc

H 1100, Ø 380



91006 MURCIA

wall light; steel, black / alabaster glass, white
Wandleuchte; Stahl, schwarz / Glas alabaster, weiss
Applique; acier, noir / verre albâtre, blanc

L 165, H 190, A 230





82748



82749



DESIGN
HIGHLIGHT
DETAIL

82748 SAVOY

pendant light; cast metal, bronzed / satin glass, white
Hängeleuchte; Metallguss, brüniert / Glas satiniert, weiss
luminaire en suspension; fonte métallique, brun / verre satiné, blanc

H 1100, Ø 740

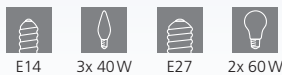

9 002759 827489



82749 SAVOY

pendant light; cast metal, bronzed / satin glass, white
Hängeleuchte; Metallguss, brüniert / Glas satiniert, weiss
luminaire en suspension; fonte métallique, brun / verre satiné, blanc

H 1100, Ø 740

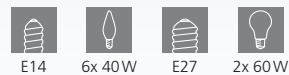

9 002759 827496





82751



82752



82747



82751 SAVOY

wall light; cast metal, bronzed / satin glass, white
Wandleuchte; Metallguss, brüniert / Glas satiniert, weiss
Applique; fonte métallique, brun / verre satiné, blanc

L 180, H 160, A 240



E14 1x 40W



9 002759 827519



82752 SAVOY

wall light; cast metal, bronzed / satin glass, white
Wandleuchte; Metallguss, brüniert / Glas satiniert, weiss
Applique; fonte métallique, brun / verre satiné, blanc

L 410, H 160, A 210



E14 2x 40W



9 002759 827526



82747 SAVOY

pendant light; cast metal, bronzed / satin glass, white
Hängeleuchte; Metallguss, brüniert / Glas satiniert, weiss
luminaire en suspension; fonte métallique, brun / verre satiné, blanc

H 1100, Ø 310



E27 2x 60W



9 002759 827472

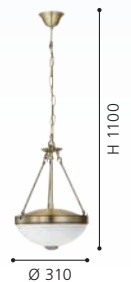



85856



85857



85859

85856 MARBELLA

ceiling light; cast metal, bronzed / alabaster glass, champagne
Deckenleuchte; Metallguss, brüniert / Glas alabaster, champagner
plafonnier; fonte métallique, brun / verre albâtre, champagne

H 410, Ø 370



E14 3x 60W



9 002759 858568



85857 MARBELLA

pendant light; cast metal, bronzed / alabaster glass, champagne
Hängeleuchte; Metallguss, brüniert / Glas alabaster, champagner
luminaire en suspension; fonte métallique, brun / verre albâtre, champagne

H 1100, Ø 740



E14 6x 60W



9 002759 858575



85859 MARBELLA

wall light; cast metal, bronzed / alabaster glass, champagne
Wandleuchte; Metallguss, brüniert / Glas alabaster, champagner
Applique; fonte métallique, brun / verre albâtre, champagne

L 170, H 200, A 230



E14 1x 40W



9 002759 858599





85858

85858 MARBELLA

pendant light; cast metal, bronzed / alabaster glass, champagne
 Hängeleuchte; Metallguss, brüniert / Glas alabaster, champagner
 luminaire en suspension; fonte métallique, brun / verre albâtre, champagne

H 1100, Ø 740



MARBELLA

These luminaires come with high quality processed alabaster glass.

Diese Leuchten sind mit hochwertigem Alabasterglas ausgestattet.

Ces luminaires viennent avec un abat-jour en verre d'albâtre haut de gamme.

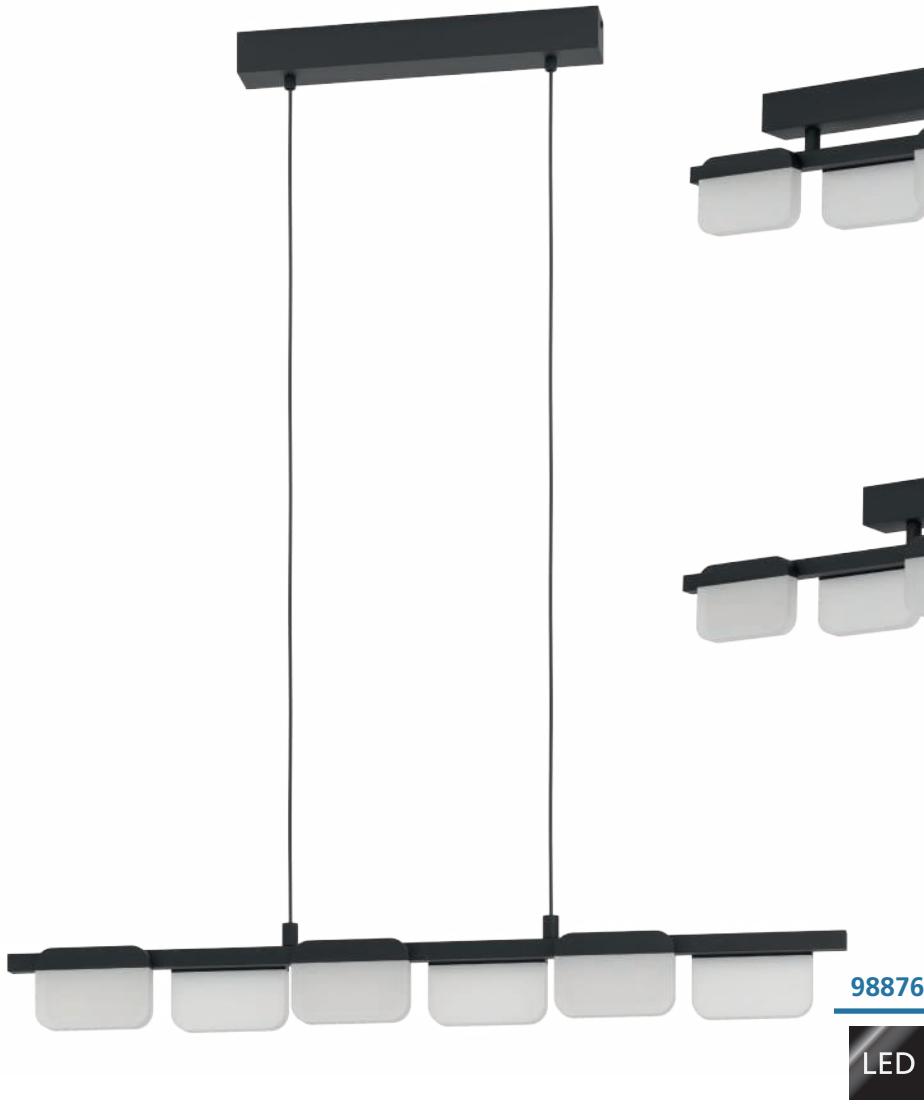

98874

LED

98875

LED

98876

LED

98876 ERVIDEL

pendant light; steel, black / plastic, satin finish
Hängeleuchte; Stahl, schwarz / Kunststoff, satiniert
luminaire en suspension; acier, noir / plastique, satiné

L 930, B 60, H 1100



6x 4,5W 2880lm



9 002759 988760

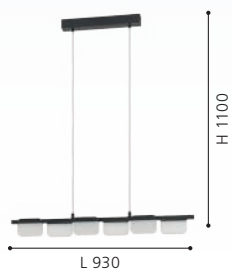

98874 ERVIDEL

ceiling light; steel, black / plastic, satin finish
Deckenleuchte; Stahl, schwarz / Kunststoff, satiniert
plafonnier; acier, noir / plastique, satiné

L 625, B 60, H 160



4x 4,5W 1920lm



9 002759 988746



98875 ERVIDEL

ceiling light; steel, black / plastic, satin finish
Deckenleuchte; Stahl, schwarz / Kunststoff, satiniert
plafonnier; acier, noir / plastique, satiné

L 930, B 60, H 160



6x 4,5W 2880lm



9 002759 988753

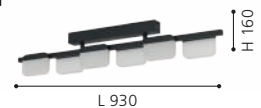



98878



98877



98878 ERVIDEL

table light; steel, black / plastic, satin finish
Tischleuchte; Stahl, schwarz / Kunststoff, satiniert
luminaire de table; acier, noir / plastique, satiné

L 155, B 60, H 500, Base: B 180, T 180



2x 4,5W 960lm



9 002759 988784



98877 ERVIDEL

wall light; steel, black / plastic, satin finish
Wandleuchte; Stahl, schwarz / Kunststoff, satiniert
Applique; acier, noir / plastique, satiné

L 320, H 90, A 80



2x 4,5W 960lm



9 002759 988777





900351



900352



900351 CLAVELLINA

ceiling light; steel, black / plastic, white
Deckenleuchte; Stahl, schwarz / Kunststoff, weiss
plafonnier; acier, noir / plastique, blanc

L 890, B 465, H 185



4x 6,8W 3200lm

900352 CLAVELLINA

pendant light; steel, black / plastic, white
Hängeleuchte; Stahl, schwarz / Kunststoff, weiss
luminaire en suspension; acier, noir / plastique, blanc

L 1200, B 400, H 1100



6x 7W 4800lm

900353 CLAVELLINA

table light; steel, black / plastic, white
Tischleuchte; Stahl, schwarz / Kunststoff, weiss
luminaire de table; acier, noir / plastique, blanc

L 550, H 450, Base: Ø 180



1x 6,8W 800lm



9 008606 241088

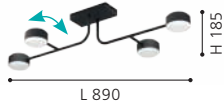

9 008606 241095

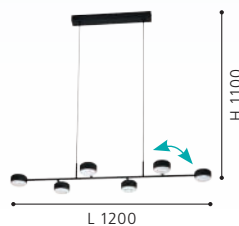

9 008606 241101

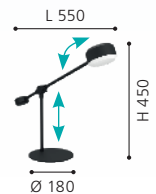



900353



900354 CLAVELLINA

floor light; steel, black / plastic, white
 Stehleuchte; Stahl, schwarz / Kunststoff, weiss
 lampadaire; acier, noir / plastique, blanc

L 1215, H 1605, Base: Ø 300



24W



2210lm



9 008606 243518

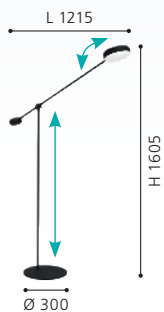

900354





99562

LED



DESIGN
HIGHLIGHT
DETAIL

99562 ISIDRO

pendant light; aluminium, steel, black / plastic, satin
Hängeleuchte; Alu, Stahl, schwarz / Kunststoff, satiniert
luminaire en suspension; aluminium, acier, noir / plastique, satiné

L 795, B 60, H 1100

LED

27W

warm
WHITE

3850lm



9 002759 995621





99561



99563



99564



99561 ISIDRO

ceiling light; aluminium, steel, black / plastic, satin finish
Deckenleuchte; Alu, Stahl, schwarz / Kunststoff, satiniert
plafonnier; aluminium, acier, noir / plastique, satiné

L 860, B 80, H 110



2x 11W 2700lm



9 002759 995614

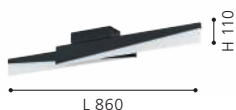

99563 ISIDRO

wall light; aluminium, steel, black / plastic, satin finish
Wandleuchte; Alu, Stahl, schwarz / Kunststoff, satiniert
Applique; aluminium, acier, noir / plastique, satiné

L 395, H 80, A 70



9W 1050lm



9 002759 995638



99564 ISIDRO

table light; aluminium, steel, black / plastic, satin finish
Tischleuchte; Alu, Stahl, schwarz / Kunststoff, satiniert
luminaire de table; aluminium, acier, noir / plastique, satiné

L 70, B 15, H 410, Base: B 150, T 130



9W 1050lm



9 002759 995645





900563

LED



CARANACOA

These luminaires have swiveling light rings.
 Diese Leuchten verfügen über schwenkbare Leuchtringe.
 Ces luminaires ont des anneaux lumineux pivotants.

900563 CARANACOA

pendant light; steel, black / plastic, white
 Hängeleuchte; Stahl, schwarz / Kunststoff, weiss
 luminaire en suspension; acier, noir / plastique, blanc

L 1170, B 230, H 1100

LED warm WHITE 5x 7W 7000lm

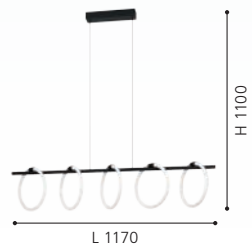



900562



900564



900565



900562 CARANACOA

pendant light; steel, black / plastic, white
 Hängeleuchte; Stahl, schwarz / Kunststoff, weiss
 luminaire en suspension; acier, noir / plastique, blanc

L 780, B 230, H 1100



3x 9W 3600lm



9 008606 244645

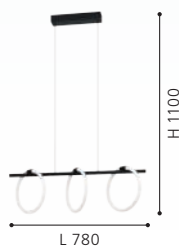

900564 CARANACOA

wall light; steel, black / plastic, white
 Wandleuchte; Stahl, schwarz / Kunststoff, weiss
 Applique; acier, noir / plastique, blanc

L 260, H 260, A 45



11,5W 1500lm



9 008606 244669



900565 CARANACOA

table light; steel, black / plastic, white
 Tischleuchte; Stahl, schwarz / Kunststoff, weiss
 luminaire de table; acier, noir / plastique, blanc

L 260, B 50, H 260, Base: Ø 100



11,5W 1500lm



9 008606 244676





900916

LED

900917 VALLEROSA

pendant light; aluminium, steel, brushed brass / plastic, white
Hängeleuchte; Alu, Stahl, messing-gebürstet / Kunststoff, weiss
luminaire en suspension; aluminium, acier, laiton brossé /
plastique, blanc

H 1100, Ø 580

LED

25,2 W

warm
WHITE

3000 lm



9 008606 277827

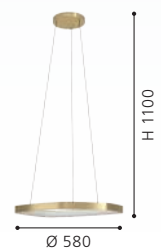



900916 VALLEROSA

ceiling light; aluminium, steel, brushed brass / plastic, white
Deckenleuchte; Alu, Stahl, messing-gebürstet / Kunststoff, weiss
plafonnier; aluminium, acier, laiton brossé / plastique, blanc

L 580, B 335, H 75



900918 VALLEROSA

table light; aluminium, steel, brushed brass / plastic, white
Tischleuchte; Alu, Stahl, messing-gebürstet / Kunststoff, weiss
luminaire de table; aluminium, acier, laiton brossé / plastique, blanc

L 220, H 425, Base: Ø 130



900919 VALLEROSA

floor light; aluminium, steel, brushed brass / plastic, white
Stehleuchte; Alu, Stahl, messing-gebürstet / Kunststoff, weiss
lampadaire; aluminium, acier, laiton brossé / plastique, blanc

L 290, H 1285, Base: Ø 200





99358



900631



900632



99358 CODRIALES

pendant light; steel, black / plastic, white
Hängeleuchte; Stahl, schwarz / Kunststoff, weiss
luminaire en suspension; acier, noir / plastique, blanc

L 780, B 300, H 1100



27W



4000lm



9 002759 993580



900631 CODRIALES

ceiling light; aluminium, black / plastic, white
Deckenleuchte; Alu, schwarz / Kunststoff, weiss
plafonnier; aluminium, noir / plastique, blanc

L 790, B 300, H 116



27W



4000lm



9 008606 241040



900632 CODRIALES

wall light; aluminium, black / plastic, white
Wandleuchte; Alu, schwarz / Kunststoff, weiss
Applique; aluminium, noir / plastique, blanc

L 180, H 320, A 65



10,8W



1400lm



9 008606 241057





900633

LED

900633 CODRIALES

table light; aluminium, black / plastic, white

Tischleuchte; Alu, schwarz / Kunststoff, weiss

luminaire de table; aluminium, noir / plastique, blanc

L 205, B 80, H 380

LED

10,8W

warm
WHITE

1500lm



9 008606 241064

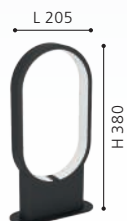



900948

LED



900951

LED

900948 GIANELLA

pendant light; aluminium, steel, black / plastic, white
 Hängeleuchte; Alu, Stahl, schwarz / Kunststoff, weiss
 luminaire en suspension; aluminium, acier, noir / plastique, blanc

L 1150, B 375, H 1100

LED warm WHITE

36W 3960lm



9 008606 275014

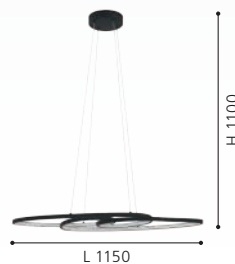

900951 GIANELLA

table light; aluminium, steel, black / plastic, white
 Tischleuchte; Alu, Stahl, schwarz / Kunststoff, weiss
 luminaire de table; aluminium, acier, noir / plastique, blanc

L 220, B 130, H 400, Base: Ø 130

LED warm WHITE

12W 1100lm



9 008606 275038

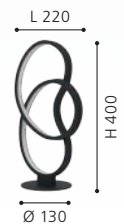



900947

LED

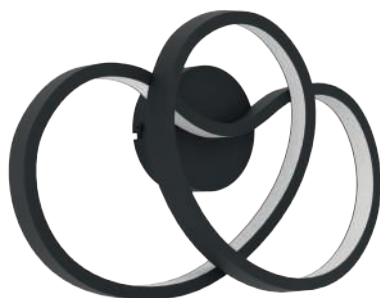

900949

LED



901015

LED

900947 GIANELLA

ceiling light; aluminium, steel, black / plastic, white
Deckenleuchte; Alu, Stahl, schwarz / Kunststoff, weiss
plafonnier; aluminium, acier, noir / plastique, blanc

L 880, B 335, H 210



36W 3960lm



9 008606 275007



900949 GIANELLA

wall light; aluminium, steel, black / plastic, white
Wandleuchte; Alu, Stahl, schwarz / Kunststoff, weiss
Applique; aluminium, acier, noir / plastique, blanc

L 365, B 240, A 100



12W 1100lm



9 008606 275021

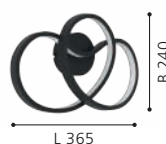

901015 GIANELLA

floor light; aluminium, steel, black / plastic, white
Stehleuchte; Alu, Stahl, schwarz / Kunststoff, weiss
lampadaire; aluminium, acier, noir / plastique, blanc

L 250, B 300, H 1025, Base: Ø 250



40W 3700lm



9 008606 291489

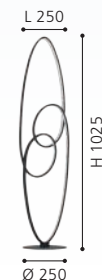



900465



900466



900465 SIBERIA

ceiling light; steel, black / plastic, white
 Deckenleuchte; Stahl, schwarz / Kunststoff, weiss
 plafonnier; acier, noir / plastique, blanc

L 780, B 160, H 235



34W 4600lm



9 008606 244041



L 780

900466 SIBERIA

pendant light; steel, black / plastic, white
 Hängeleuchte; Stahl, schwarz / Kunststoff, weiss
 luminaire en suspension; acier, noir / plastique, blanc

L 780, B 160, H 1100



34W 4500lm



9 008606 244058

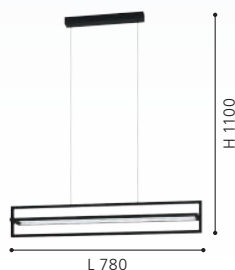

L 780

900467 SIBERIA

wall light; steel, black / plastic, white
 Wandleuchte; Stahl, schwarz / Kunststoff, weiss
 Applique; acier, noir / plastique, blanc

L 160, H 300, A 190



15,5W 2200lm



9 008606 244065

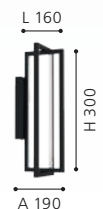

A 190



900467

LED

incl./inkl./inclus



900468

LED

incl./inkl./inclus



900469

LED

incl./inkl./inclus



900468 SIBERIA

table light; steel, black / plastic, white
Tischleuchte; Stahl, schwarz / Kunststoff, weiss
luminaire de table; acier, noir / plastique, blanc

L 160, B 160, H 430, Base: B 160, T 160



15,5W 2200lm



9 008606 244072

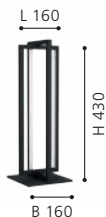

900469 SIBERIA

floor light; steel, black / plastic, white
Stehleuchte; Stahl, schwarz / Kunststoff, weiss
lampadaire; acier, noir / plastique, blanc

L 200, B 160, H 1330, Base: B 200, T 160



34W 4600lm



9 008606 244089

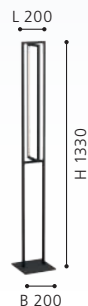



99799

LED



99801

LED



99802

LED



99799 LEJIAS

ceiling light; steel, black / plastic, transparent
 Deckenleuchte; Stahl, schwarz / Kunststoff, transparent
 plafonnier; acier, noir / plastique, transparent

L 450, B 450, H 75

LED

warm
WHITE



21W 3050lm

99801 LEJIAS

ceiling light; steel, black / plastic, transparent
 Deckenleuchte; Stahl, schwarz / Kunststoff, transparent
 plafonnier; acier, noir / plastique, transparent

L 780, B 80

LED

warm
WHITE



21,5W 2600lm

99802 LEJIAS

pendant light; steel, black / plastic, transparent
 Hängeleuchte; Stahl, schwarz / Kunststoff, transparent
 luminaire en suspension; acier, noir / plastique, transparent

L 780, B 80, H 1750

LED

warm
WHITE



21,5W 2600lm



9 002759 997991

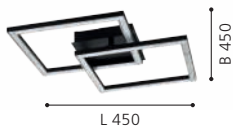

9 002759 998011



9 002759 998028

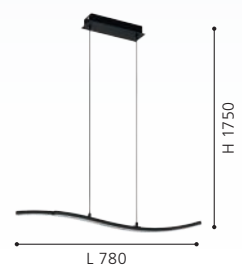



99803



99804



99805



99803 LEJIAS

wall light; steel, black / plastic, transparent
Wandleuchte; Stahl, schwarz / Kunststoff, transparent
Applique; acier, noir / plastique, transparent

L 90, H 285



8W 1050lm



9 002759 998035



99804 LEJIAS

table light; steel, black / plastic, transparent
Tischleuchte; Stahl, schwarz / Kunststoff, transparent
luminaire de table; acier, noir / plastique, transparent

H 330, Base: B 140, T 140



8W 900lm



9 002759 998042



99805 LEJIAS

floor light; steel, black / plastic, transparent
Stehleuchte; Stahl, schwarz / Kunststoff, transparent
lampadaire; acier, noir / plastique, transparent

H 1230, Base: B 230, T 230



16W 2050lm



9 002759 998059

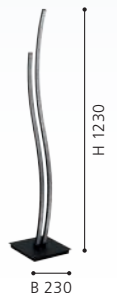

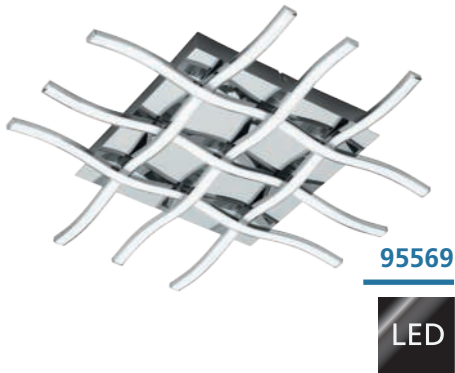

95569

LED



96104

LED



96102

LED



95569 LASANA 1

wall/ceiling light; steel, chrome / plastic, white
Wand- / Deckenleuchte; Stahl, chrom / Kunststoff, weiss
Applique/Plafonnier; acier, chrome / plastique, blanc

L 500, B 500, H 65

LED

warm
WHITE



6x 6W 4860lm



9 002759 955694

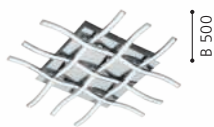

L 500

96104 LASANA 2

pendant light; steel, aluminium, chrome / plastic, white
Hängeleuchte; Stahl, Alu, chrom / Kunststoff, weiss
luminaire en suspension; acier, aluminium, chrome / plastique, blanc

L 1200, B 80, H 1200

LED

warm
WHITE



2x 13W 3400lm



9 002759 961046



L 1200

96102 LASANA 2

pendant light; steel, aluminium, chrome / plastic, white
Hängeleuchte; Stahl, Alu, chrom / Kunststoff, weiss
luminaire en suspension; acier, aluminium, chrome / plastique, blanc

L 1000, B 80, H 1200

LED

warm
WHITE



35W 5300lm



9 002759 961022

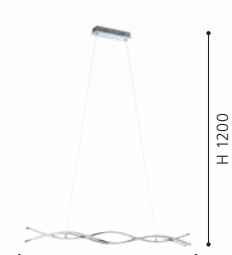

L 1000

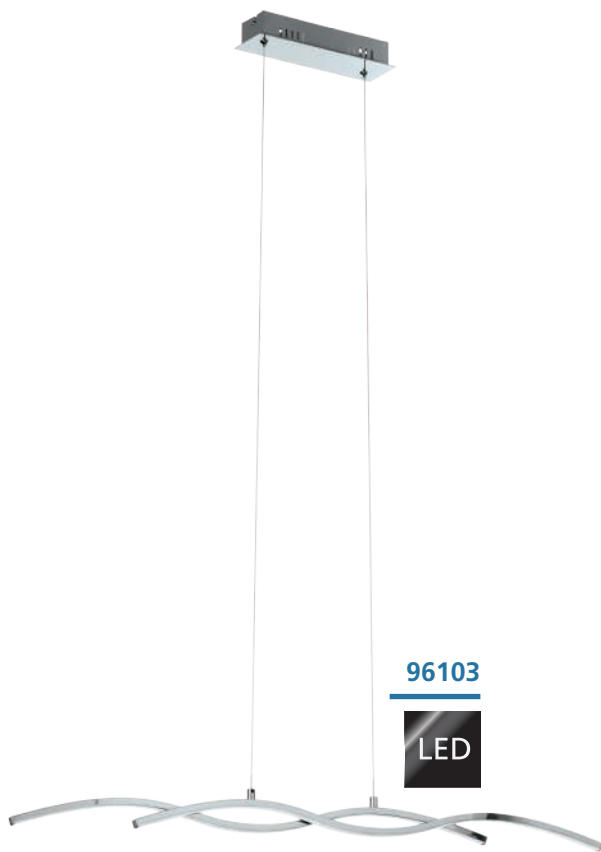

96103



96105



96106



96103 LASANA 2

pendant light; steel, aluminium, chrome / plastic, white
 Hängeleuchte; Stahl, Alu, chrom / Kunststoff, weiss
 luminaire en suspension; acier, aluminium, chrome / plastique, blanc

L 870, B 80, H 1200



19W 2600lm



9 002759 961039

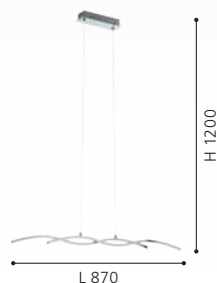

96105 LASANA 2

table light; steel, aluminium, chrome / plastic, white
 Tischleuchte; Stahl, Alu, chrom / Kunststoff, weiss
 luminaire de table; acier, aluminium, chrome / plastique, blanc

L 160, B 100, H 460



2x 5,5W 1440lm



9 002759 961053



96106 LASANA 2

floor light; steel, aluminium, chrome / plastic, white
 Stehleuchte; Stahl, Alu, chrom / Kunststoff, weiss
 lampadaire; acier, aluminium, chrome / plastique, blanc

L 250, B 130, H 1420



36W 4700lm



9 002759 961060



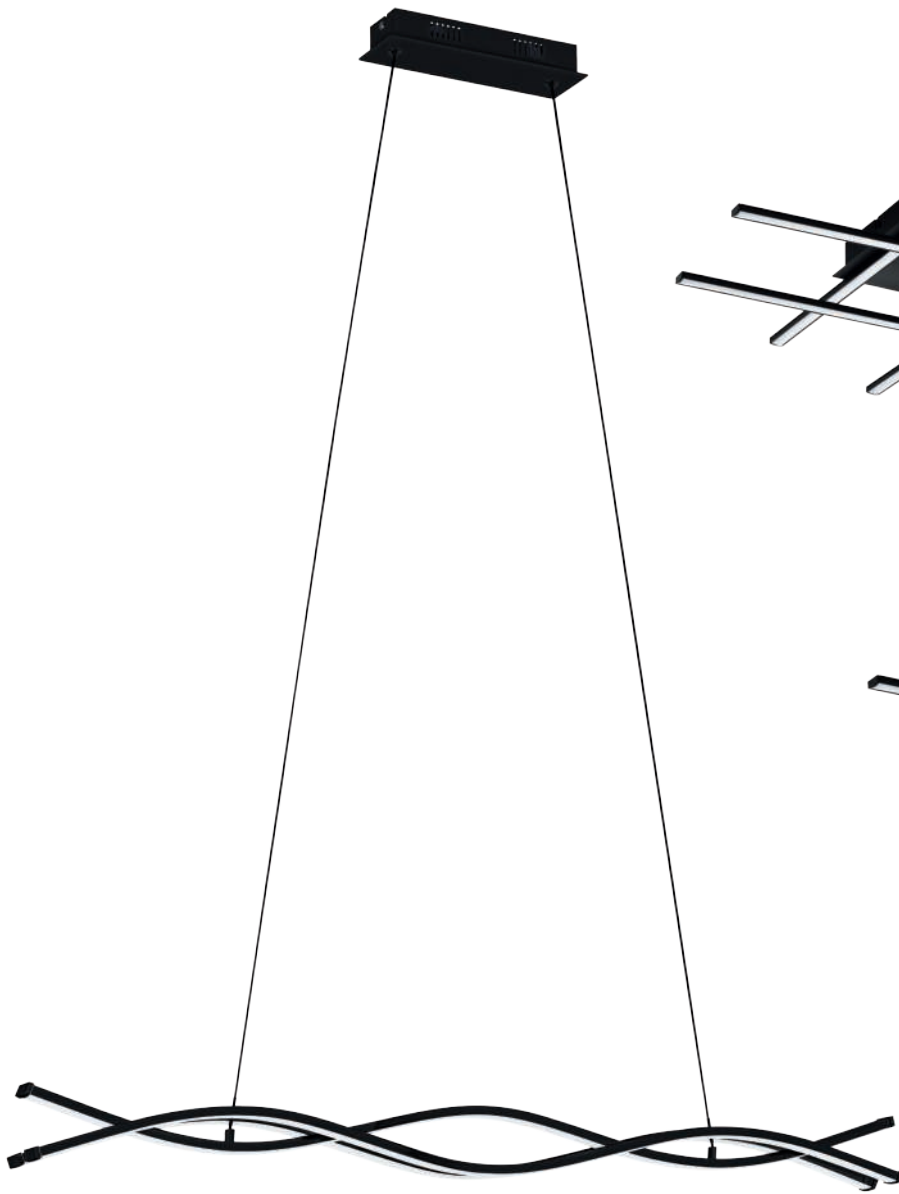

99317

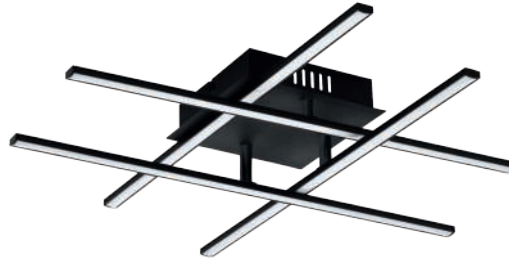

99316



99315



99317 LASANA 3

pendant light; steel, aluminium, black / plastic, white
Hängeleuchte; Stahl, Alu, schwarz / Kunststoff, weiss
luminaire en suspension; acier, aluminium, noir / plastique, blanc

L 985, B 80, H 1200



33W



4500lm



9 002759 993177

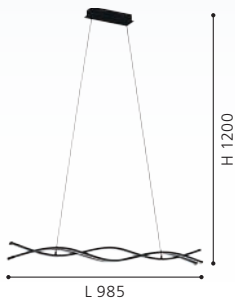

99316 LASANA 3

wall/ceiling light; steel, aluminium, black / plastic, white
Wand- / Deckenleuchte; Stahl, Alu, schwarz / Kunststoff, weiss
Applique/Plafonnier; acier, aluminium, noir / plastique, blanc

L 500, B 500, H 95



4x 5,3W



2800lm



9 002759 993160

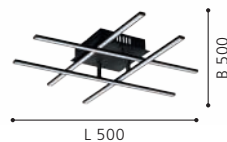

99315 LASANA 3

wall/ceiling light; steel, aluminium, black / plastic, white
Wand- / Deckenleuchte; Stahl, Alu, schwarz / Kunststoff, weiss
Applique/Plafonnier; acier, aluminium, noir / plastique, blanc

L 500, B 145, H 90



3x 3,5W



1500lm



9 002759 993153

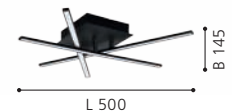



99319

LED



99318

LED

99319 LASANA 3

floor light; steel, aluminium, black / plastic, white
 Stehleuchte; Stahl, Alu, schwarz / Kunststoff, weiss
 lampadaire; acier, aluminium, noir / plastique, blanc

L 250, B 130, H 1420, Base: B 230, T 150



36W 4700lm



9 002759 993191



99318 LASANA 3

table light; steel, aluminium, black / plastic, white
 Tischleuchte; Stahl, Alu, schwarz / Kunststoff, weiss
 luminaire de table; acier, aluminium, noir / plastique, blanc

L 160, B 100, H 460, Base: B 180, T 100



11,5W 1280lm



9 002759 993184





95147

LED



32048

LED

95147 LASANA

pendant light; aluminium, steel, chrome / plastic, white
 Hängeleuchte; Alu, Stahl, chrom / Kunststoff, weiss
 luminaire en suspension; aluminium, acier, chrome / plastique, blanc

L 900, H 1100

LED

30W

warm
WHITE

3500lm



9 002759 951474

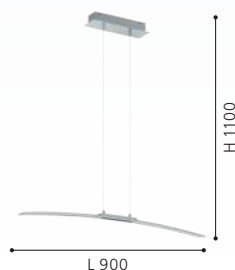

32048 LASANA

pendant light; aluminium, steel, chrome / plastic, white
 Hängeleuchte; Alu, Stahl, chrom / Kunststoff, weiss
 luminaire en suspension; aluminium, acier, chrome / plastique, blanc

L 900, H 1000

LED

15W

warm
WHITE

1800lm



9 002759 320485

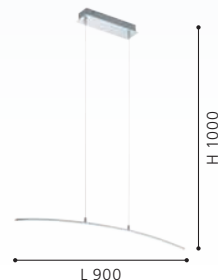

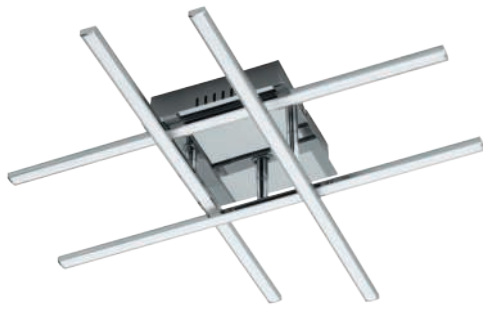

95568

LED



95567

LED



96866

LED

95568 LASANA 1

wall/ceiling light; steel, chrome / plastic, white
Wand- / Deckenleuchte; Stahl, chrom / Kunststoff, weiss
Applique/Plafonnier; acier, chrome / plastique, blanc

L 500, B 500, H 95



4x 5,3W 2800lm



9 002759 955687

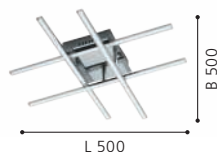

95567 LASANA 1

wall/ceiling light; steel, chrome / plastic, white
Wand- / Deckenleuchte; Stahl, chrom / Kunststoff, weiss
Applique/Plafonnier; acier, chrome / plastique, blanc

L 500, B 160, H 95



3x 3,5W 1500lm



9 002759 955670



96866 TARANDELL

pendant light; aluminium, steel, chrome / plastic, satin finish
Hängeleuchte; Alu, Stahl, chrom / Kunststoff, satiniert
luminaire en suspension; aluminium, acier, chrome / plastique, satiné

L 1180, B 60, H 930 - 1620



2x 12,5W 3300lm



9 002759 968663

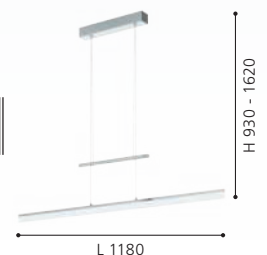



99322

LED



99321

LED



99323

LED

99322 RONCADE 1

wall/ceiling light; steel, aluminium, black / plastic, white
Wand- / Deckenleuchte; Stahl, Alu, schwarz / Kunststoff, weiss
Applique/Plafonnier; acier, aluminium, noir / plastique, blanc

L 1160, B 180, H 115



36W 4600lm

99321 RONCADE 1

wall/ceiling light; steel, aluminium, black / plastic, white
Wand- / Deckenleuchte; Stahl, Alu, schwarz / Kunststoff, weiss
Applique/Plafonnier; acier, aluminium, noir / plastique, blanc

L 650, B 130, H 45



21W 2800lm

99323 SELVINA 1

ceiling light; steel, aluminium, black / plastic, white
Deckenleuchte; Stahl, Alu, schwarz / Kunststoff, weiss
plafonnier; acier, aluminium, noir / plastique, blanc

L 690, B 300, H 115



19W 2700lm



9 002759 993221

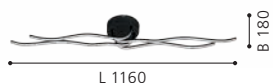

9 002759 993214

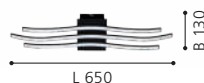

9 002759 993238





31996



31995



96329



31996 RONCADE

wall/ceiling light; aluminium, steel, chrome / plastic, white
Wand- / Deckenleuchte; Alu, Stahl, chrom / Kunststoff, weiss
Applique/Plafonnier; aluminium, acier, chrome / plastique, blanc

L 1085, B 160, H 125



37W 4700lm



9 002759 319960

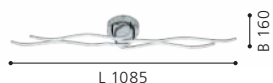

31995 RONCADE

wall/ceiling light; aluminium, steel, chrome / plastic, white
Wand- / Deckenleuchte; Alu, Stahl, chrom / Kunststoff, weiss
Applique/Plafonnier; aluminium, acier, chrome / plastique, blanc

L 650, B 130, H 45



21W 2800lm



9 002759 319953

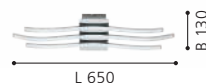

96329 SELVINA

ceiling light; aluminium, chrome / plastic, white
Deckenleuchte; Alu, chrom / Kunststoff, weiss
plafonnier; aluminium, chrome / plastique, blanc

L 690, B 300, H 115



19W 2700lm



9 002759 963293





96308

LED

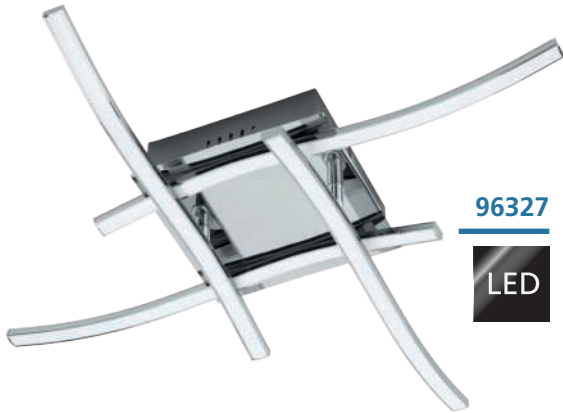

96327

LED



96326

LED

96308 SELVINA

ceiling light; aluminium, chrome / plastic, white
Deckenleuchte; Alu, chrom / Kunststoff, weiss
plafonnier; aluminium, chrome / plastique, blanc

L 745, B 175, H 85

LED

warm
WHITE
2900lm



9 002759 963088



96327 VALMORA

ceiling light; aluminium, chrome / plastic, white
Deckenleuchte; Alu, chrom / Kunststoff, weiss
plafonnier; aluminium, chrome / plastique, blanc

L 560, B 560, H 105

LED

warm
WHITE
2450lm



9 002759 963279

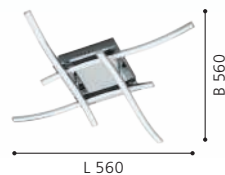

96326 VALMORA

ceiling light; aluminium, chrome / plastic, white
Deckenleuchte; Alu, chrom / Kunststoff, weiss
plafonnier; aluminium, chrome / plastique, blanc

L 590, B 125, H 90

LED

warm
WHITE
1700lm



9 002759 963262

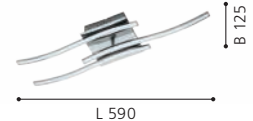



96332

LED



96305

LED



96331

LED

96332 VALMORA

wall light; aluminium, chrome / plastic, white
Wandleuchte; Alu, chrom / Kunststoff, weiss
Applique; aluminium, chrome / plastique, blanc

L 115, H 450, A 90



9W 1250lm



9 002759 963323



96331 NEVADO

pendant light; aluminium, chrome / plastic, white
Hängeleuchte; Alu, chrom / Kunststoff, weiss
luminaire en suspension; aluminium, chrome / plastique, blanc

L 900, B 80, H 1100



23,6W 3400lm



9 002759 963316

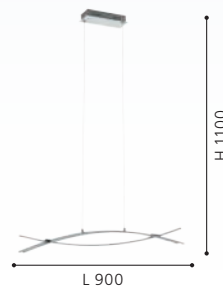

96305 NEVADO

ceiling light; aluminium, chrome / plastic, white
Deckenleuchte; Alu, chrom / Kunststoff, weiss
plafonnier; aluminium, chrome / plastique, blanc

L 500, B 500, H 115



18W 2450lm



9 002759 963057

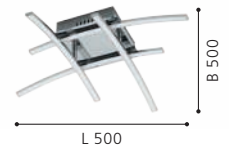



31997

LED



98889

LED



99559

LED

31997 RONCADE

table light; aluminium, steel, chrome / plastic, white
Tischleuchte; Alu, Stahl, chrom / Kunststoff, weiss
luminaire de table; aluminium, acier, chrome / plastique, blanc

L 195, B 150, H 335

LED

warm
WHITE



8,8W

866lm

98889 PALOZZA 1

wall light; aluminium, satin nickel / plastic, white
Wandleuchte; Alu, nickel-matt / Kunststoff, weiss
Applique; aluminium, nickel mat / plastique, blanc

L 170, H 425, A 60

LED

warm
WHITE



10W

1300lm

99559 PALOZZA 1

table light; aluminium, satin nickel / plastic, white
Tischleuchte; Alu, nickel-matt / Kunststoff, weiss
luminaire de table; aluminium, nickel mat / plastique, blanc

L 150, B 110, H 420

LED

warm
WHITE



11W

1400lm



9 002759 319977



9 002759 988890



9 002759 995591

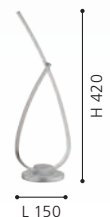



96306

LED



97361

LED

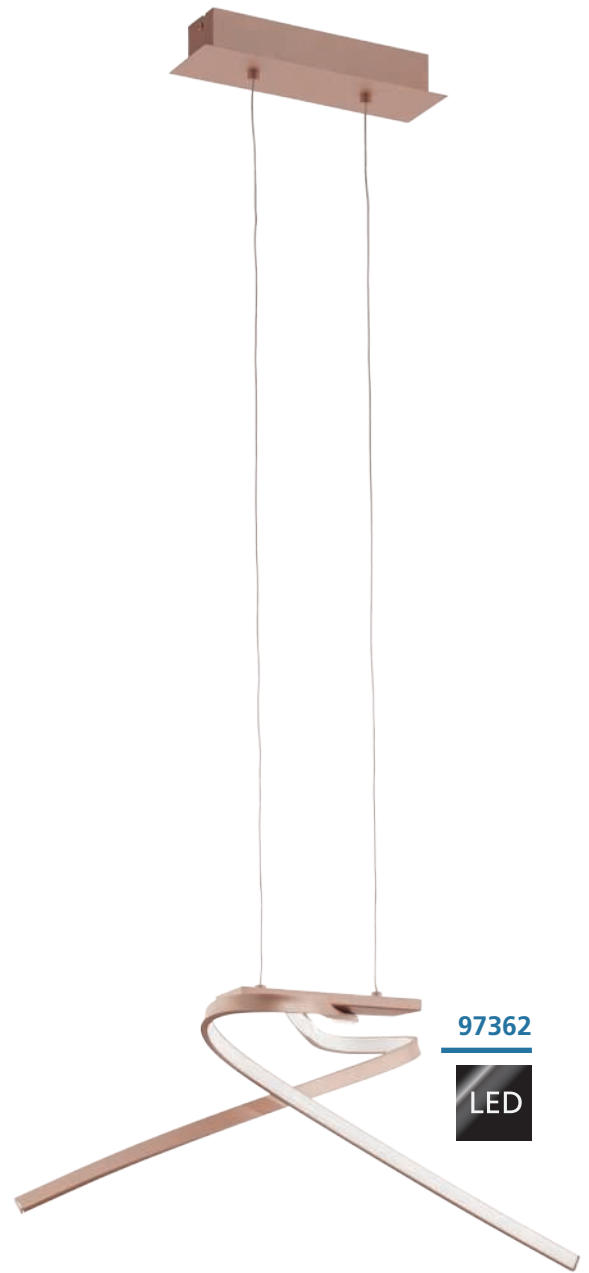

97362

LED

96306 SELVINA

ceiling light; aluminium, chrome / plastic, white
Deckenleuchte; Alu, chrom / Kunststoff, weiss
plafonnier; aluminium, chrome / plastique, blanc

L 460, B 390, H 380



28W 3600lm



9 002759 963064

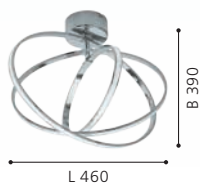

97361 PALOZZA

ceiling light; aluminium, rose gold / plastic, white
Deckenleuchte; Alu, roségold / Kunststoff, weiss
plafonnier; aluminium, rose or / plastique, blanc

L 705, B 315, H 125



19W 2700lm



9 002759 973612

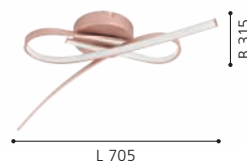

97362 PALOZZA

pendant light; aluminium, rose gold / plastic, white
Hängeleuchte; Alu, roségold / Kunststoff, weiss
luminaire en suspension; aluminium, rose or / plastique, blanc

L 705, B 315, H 1100



19W 2600lm



9 002759 973629





LIGHTING FAMILIES / GLASS CHANDELIERS

LEUCHTENFAMILIEN / GLASLUSTER
FAMILLES DE LUMINAIRES / LUSTRES EN VERRE



EN SPARKLING

Extravagant lighting – our glass chandeliers will give you light in a new diversity while ensuring an extraordinary ambience. Our chandeliers are true jewels on your ceiling and spread their elegance in your entire living area.

DE FUNKELN

Beleuchtung der Extravaganz – Mit unseren Glaslustern erleben Sie Licht in neuer Vielfalt und sorgen für ein außergewöhnliches Ambiente. Unsere Kronleuchter werden zum wahren Schmuckstück und bringen Eleganz in all Ihre Wohnbereiche.

FR DU SCINTILLEMENT

Un éclairage riche en extravagance – Avec nos lustres en verre, vous faites l'expérience de la lumière dans une nouvelle multiplicité et vous assurez une ambiance extraordinaire. Nos plafonniers lustres en deviennent de vrais bijoux et prêtent de l'élégance à tous vos espaces d'habitat.





OVERVIEW

LIGHTING FAMILIES / GLAS CHANDELIERS
LEUCHTENFAMILIEN / GLASLUSTER
FAMILLES DE LUMINAIRES / LUSTRES EN VERRE



BASILANO 1
340-341



BASILANO
342-343



CARPENTO
344



This product is available in different colors and shapes. / Dieser Artikel ist in unterschiedlichen Farben und Formen verfügbar. /
Cet article est disponible en différentes couleurs et formes.





39103 BASILANO 1

pendant light; steel, chrome / glass, clear
 Hängeleuchte; Stahl, chrom / Glas, klar
 luminaire en suspension; acier, chrome / verre, transparent

H 1500, Ø 1000



E14 18x 40W



9 002759 391034



39101 BASILANO 1

pendant light; steel, chrome / glass, clear
 Hängeleuchte; Stahl, chrom / Glas, klar
 luminaire en suspension; acier, chrome / verre, transparent

H 1300, Ø 820

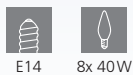

E14 8x 40W



9 002759 391010



39099 BASILANO 1

pendant light; steel, chrome / glass, clear
 Hängeleuchte; Stahl, chrom / Glas, klar
 luminaire en suspension; acier, chrome / verre, transparent

H 1300, Ø 720



E14 6x 40W



9 002759 390990





39099



39102

39102 BASILANO 1

pendant light; steel, chrome / glass, clear

Hängeleuchte; Stahl, chrom / Glas, klar

luminaire en suspension; acier, chrome / verre, transparent

H 1500, Ø 1000



E14



12x 40W



9 002759 391027



H 1500

Ø 1000



39095



39092

39095 BASILANO

pendant light; steel, chrome / glass, cognac
 Hängeleuchte; Stahl, chrom / Glas, cognac
 luminaire en suspension; acier, chrome / verre, cognac

H 1500, Ø 1000



E14 18x 40W



9 002759 390952



39092 BASILANO

pendant light; steel, chrome / glass, cognac
 Hängeleuchte; Stahl, chrom / Glas, cognac
 luminaire en suspension; acier, chrome / verre, cognac

H 1300, Ø 720



E14 6x 40W



9 002759 390921





39093



39094

39093 BASILANO

pendant light; steel, chrome / glass, cognac
 Hängeleuchte; Stahl, chrom / Glas, cognac
 luminaire en suspension; acier, chrome / verre, cognac

H 1300, Ø 820



E14 8x 40W



9 002759 390938



39094 BASILANO

pendant light; steel, chrome / glass, cognac
 Hängeleuchte; Stahl, chrom / Glas, cognac
 luminaire en suspension; acier, chrome / verre, cognac

H 1500, Ø 1000



E14 12x 40W



9 002759 390945





39113

39113 CARPENTO

pendant light; steel, chrome / glass, white
 Hängeleuchte; Stahl, chrom / Glas, weiss
 luminaire en suspension; acier, chrome / verre, blanc

H 1200, Ø 590



E14 5x 40W



9 002759 391133



39114 CARPENTO

pendant light; steel, chrome / glass, white
 Hängeleuchte; Stahl, chrom / Glas, weiss
 luminaire en suspension; acier, chrome / verre, blanc

H 1300, Ø 700



E14 8x 40W



9 002759 391140





39114





HANGING & PENDANT LUMINAIRES

HÄNGE- & PENDELLEUCHTEN
LUMINAIRES SUSPENSIONS



EN **SUSPENDED LIGHTING**

Our wide variety of suspended and pendant luminaires contain classical as well as extravagant designs and supply any furnishing style. Set beautiful accents with your favourites and give your home a special atmosphere.

DE **BELEUCHTUNG ZUM ABHÄNGEN**

Unser breitgefächertes Hänge- und Pendelleuchten-Sortiment beinhaltet sowohl klassische als auch extravagante Designs und bedient jeden Einrichtungsstil. Setzen Sie mit Ihren Favoriten schöne Akzente und verleihen Sie Ihrem Zuhause eine besondere Atmosphäre.

FR **ÉCLAIRAGES SUSPENDUS**























































Notre large gamme d'éclairages suspendus et pendulaires comprend aussi bien des designs classiques qu'extravagants et est adaptée à tout style d'ameublement. Mettez avec vos favoris de beaux accents et donnez une atmosphère particulière à votre intérieur.



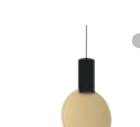

OVERVIEW

HANGING & PENDANT LUMINAIRES
HÄNGE- & PENDELLEUCHTEN
LUMINAIRES SUSPENSIONS

 OIELLA 350-351	 AGUILARES 353	 LEBALIO 353	 MARYVILLA 354	 ALOBRASE 355, 358-361	 BATISTA 355	 CAPRAROLA 356	 COMINIO 357
 CADAQUES 361	 CADAQUES 1 361	 ARISCANI 362-363	 MURMILLO 364	 FARSALA 365	 MANTUNALLE 1 367	 BELESER 367	 MANTUNALLE 368
 SELVINO 370-371	 ALBARACCIN 372-373	 LAGUNITAS 374	 CERASELLA 375	 ROCAMAR 376,378	 ROCAMAR 1 377-378	 CORETTO 377	 LONCINO 1 379
 ALEANDRO 1 380	 ROMAGNESE 380	 VALLASPRA 381	 BATISTA 3 381	 BOLSANO 382	 CLEMENTE 383	 CARDITO 1 384-385	 VARRAZO 385
 LUBERIO 386	 MONTEFIO 1 386-387	 MIOGLIA 1 388	 CONESSA 388-389	 CARTAMA 391	 MONTEFINO 392	 CORTENOVA 394	 POZUETA 1 397
 POZUETA 399	 BOCADELLA 400	 MEZZANA 400	 GRADOLI 402	 GRADOLI 1 403	 MANIZALES 403	 CUMIOLE 404	 MONTEBALDO 405
 BITACHITO 405	 CORTADERAS 406	 RONDO 3 407	 PINETINA 407	 NARICES 407	 SARONA 408	 LOBATIA 409	 SILVARES 410



This product is available in different colors and shapes. / Dieser Artikel ist in unterschiedlichen Farben und Formen verfügbar. / Cet article est disponible en différentes couleurs et formes.





99614 OILELLA

pendant light; steel, black, brass / glass vaporized, black-brown-transparent

Hängeleuchte; Stahl, schwarz, messing / Glas bedampft, schwarz-braun-transparent

luminaire en suspension; acier, noir, laiton / verre vaporisé, noir marron transparent

H 1100, Ø 190



E27

1x 40W



9 002759 996147



99615 OILELLA

pendant light; steel, black, brass / glass vaporized, black-brown-transparent

Hängeleuchte; Stahl, schwarz, messing / Glas bedampft, schwarz-braun-transparent

luminaire en suspension; acier, noir, laiton / verre vaporisé, noir marron transparent

L 950, B 190, H 1100



E27

3x 40W



9 002759 996154



99616 OILELLA

pendant light; steel, black, brass / glass vaporized, black-grey-transparent

Hängeleuchte; Stahl, schwarz, messing / Glas bedampft, schwarz-grau-transparent

luminaire en suspension; acier, noir, laiton / verre vaporisé, noir gris transparent

H 1100, Ø 190



E27

1x 40W



9 002759 996161





99617

99617 OILELLA

pendant light; steel, black, brass / glass vaporized, black-grey-transparent

Hängeleuchte; Stahl, schwarz, messing / Glas bedampft, schwarz-grau-transparent

luminaire en suspension; acier, noir, laiton / verre vaporisé, noir gris transparent

L 950, B 190, H 1100



E27



3x 40W



9 002759 996178



DESIGN
HIGHLIGHT
DETAIL



900196



900195



99314



99314

900196 AGUILARES

pendant light; steel, black / glass vaporized, black-grey-transparent

Hängeleuchte; Stahl, schwarz / Glas bedampft, schwarz-grau-transparent

luminaire en suspension; acier, noir / verre vaporisé, noir gris transparent

H 1100, Ø 430

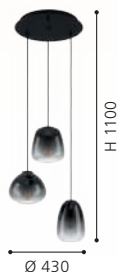

900195 AGUILARES

pendant light; steel, black / glass vaporized, black-grey-transparent

Hängeleuchte; Stahl, schwarz / Glas bedampft, schwarz-grau-transparent

luminaire en suspension; acier, noir / verre vaporisé, noir gris transparent

L 840, B 195, H 1045



99314 LEBALIO

pendant light; steel, bronzed / glass vaporized, black-transparent

Hängeleuchte; Stahl, brüniert / Glas bedampft, schwarz-transparent

luminaire en suspension; acier, brun / verre vaporisé, noir transparent

L 1125, B 195, H 1100

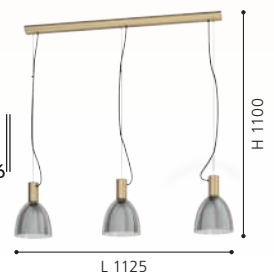

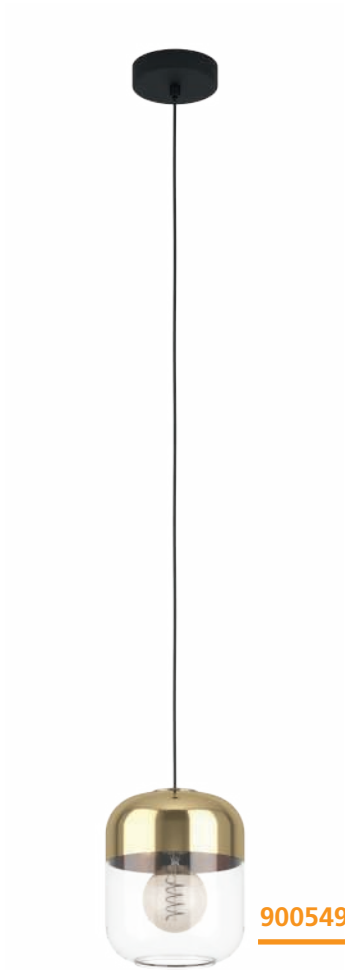

900549



900551



MARYVILLA

900549 MARYVILLA

pendant light; steel, black, bronzed / glass vaporized, clear, gold
 Hängeleuchte; Stahl, schwarz, brüniert / Glas bedampft, klar, gold
 luminaire en suspension; acier, noir, brun / verre vaporisé, transparent, or

H 1100, Ø 170



E27 1x 40W



9 008606 244553



900551 MARYVILLA

pendant light; steel, black, bronzed / glass vaporized, clear, gold
 Hängeleuchte; Stahl, schwarz, brüniert / Glas bedampft, klar, gold
 luminaire en suspension; acier, noir, brun / verre vaporisé, transparent, or

L 870, B 170, H 1100



E27 3x 40W



9 008606 244560



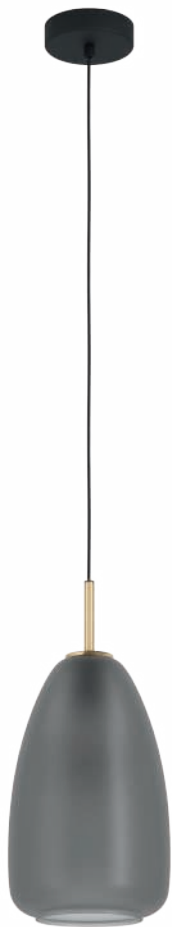

900506



900507



900508

900506 | 900507 | 900508

900506 ALOBRASE

pendant light; steel, black, brushed brass / satin glass, grey matt
Hängeleuchte; Stahl, schwarz, messing-gebürstet / Glas satiniert, grau matt
luminaire en suspension; acier, noir, laiton brossé / verre satiné, gris mat

H 1100, Ø 200



900507 BATISTA

pendant light; steel, black, brushed brass / satin glass, grey matt
Hängeleuchte; Stahl, schwarz, messing-gebürstet / Glas satiniert, grau matt
luminaire en suspension; acier, noir, laiton brossé / verre satiné, gris mat

H 1100, Ø 120



900508 BATISTA

pendant light; steel, black, brushed brass / satin glass, grey matt
Hängeleuchte; Stahl, schwarz, messing-gebürstet / Glas satiniert, grau matt
luminaire en suspension; acier, noir, laiton brossé / verre satiné, gris mat

L 945, B 120, H 1100

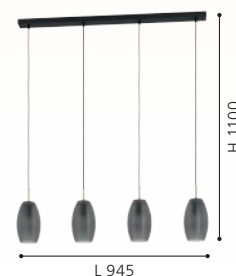



900813

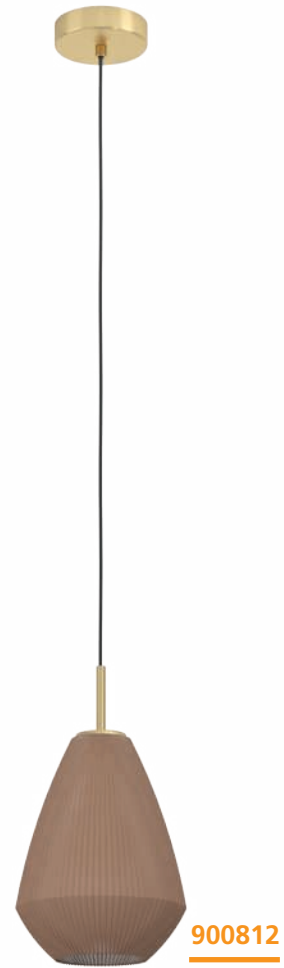

900812

CAPRAROLA, COMINIO

The shade colours of these luminaires look very different when switched on and off.

Die Schirmfarben dieser Leuchten sehen im ein- und ausgeschalteten Zustand sehr unterschiedlich aus.

Les couleurs de la teinte de ces luminaires sont très différentes lorsqu'ils sont allumés et éteints.



900813 CAPRAROLA

pendant light; steel, brushed brass / satin glass, sandy
 Hängeleuchte; Stahl, messing-gebürstet / Glas satiniert, sandfarben
 luminaire en suspension; acier, laiton brossé / verre satiné, couleur sable

L 900, B 200, H 1100



E27



3x 40W



9 008606 274338



900812 CAPRAROLA

pendant light; steel, brushed brass / satin glass, sandy
 Hängeleuchte; Stahl, messing-gebürstet / Glas satiniert, sandfarben
 luminaire en suspension; acier, laiton brossé / verre satiné, couleur sable

H 1100, Ø 200



E27



1x 40W



9 008606 274321

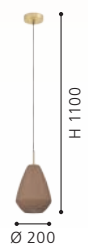



900893



900894

900893 COMINIO

pendant light; steel, taupe / etched glass, sandy
 Hängeleuchte; Stahl, taupe / Glas geätzt, sandfarben
 luminaire en suspension; acier, taupe / verre gravé, couleur sable

H 1100, Ø 185



E27 1x 40W



9 008606 274581



900894 COMINIO

pendant light; steel, taupe / etched glass, sandy
 Hängeleuchte; Stahl, taupe / Glas geätzt, sandfarben
 luminaire en suspension; acier, taupe / verre gravé, couleur sable

L 885, B 185, H 1100



E27 3x 40W



9 008606 274598

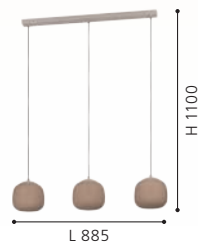



98614

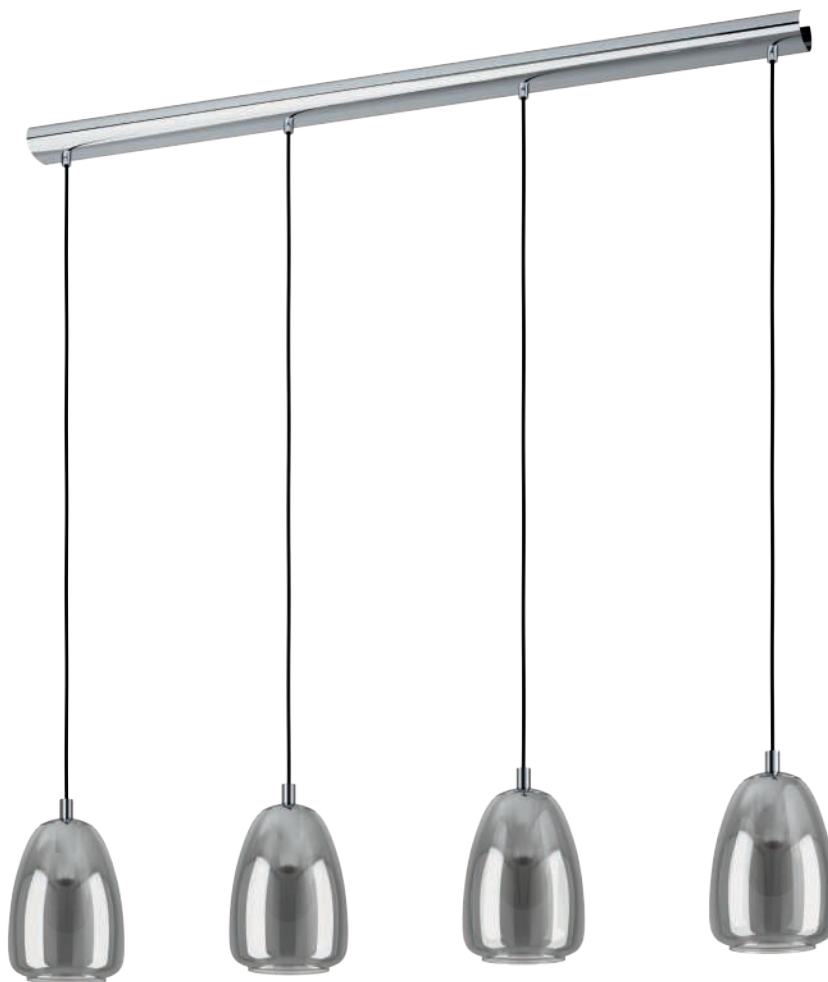

98616



ALOBRASE

98614 ALOBRASE

pendant light; steel, chrome / glass vaporized, black-transparent
 Hängeleuchte; Stahl, chrom / Glas bedampft, schwarz-transparent
 luminaire en suspension; acier, chrome / verre vaporisé, noir transparent

H 1100, Ø 300



98616 ALOBRASE

pendant light; steel, chrome / glass vaporized, black-transparent
 Hängeleuchte; Stahl, chrom / Glas bedampft, schwarz-transparent
 luminaire en suspension; acier, chrome / verre vaporisé, noir transparent

L 1080, B 150, H 1100



98615 ALOBRASE

pendant light; steel, chrome / glass vaporized, black-transparent
 Hängeleuchte; Stahl, chrom / Glas bedampft, schwarz-transparent
 luminaire en suspension; acier, chrome / verre vaporisé, noir transparent

H 1100, Ø 200



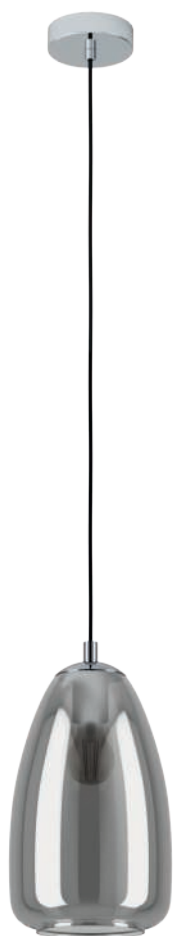

98615

98617 ALOBRASE

pendant light; steel, chrome / glass vaporized, black-transparent
Hängeleuchte; Stahl, chrom / Glas bedampft, schwarz-transparent
luminaire en suspension; acier, chrome / verre vaporisé, noir transparent

H 1500, Ø 540



E27



5x 40W





98647

98647 ALOBRASE

pendant light; steel, brushed brass / glass vaporized, amber
 Hängeleuchte; Stahl, messing-gebürstet / Glas bedampft, amber
 luminaire en suspension; acier, laiton brossé / verre vaporisé, ambre

H 1100, Ø 300



9 002759 986476



98649

98649 ALOBRASE

pendant light; steel, brushed brass / glass vaporized, amber
 Hängeleuchte; Stahl, messing-gebürstet / Glas bedampft, amber
 luminaire en suspension; acier, laiton brossé / verre vaporisé, ambre

L 1080, B 150, H 1100



9 002759 986490

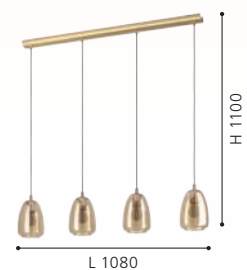



98648



98582



98585

98648 ALOBRASE

pendant light; steel, brushed brass / glass vaporized, amber
Hängeleuchte; Stahl, messing-gebürstet / Glas bedampft, amber
luminaire en suspension; acier, laiton brossé / verre vaporisé, ambre

H 1100, Ø 200



E27 1x 40W



9 002759 986483

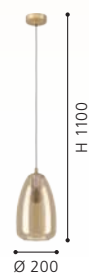

98582 CADAQUES

pendant light; steel, black / smoked glass, black-transparent
Hängeleuchte; Stahl, schwarz / Rauchglas, schwarz-transparent
luminaire en suspension; acier, noir / verre fumé, noir transparent

H 1100, Ø 180



E27 1x 40W



9 002759 985820



98585 CADAQUES 1

pendant light; steel, black / smoked glass, black-transparent
Hängeleuchte; Stahl, schwarz / Rauchglas, schwarz-transparent
luminaire en suspension; acier, noir / verre fumé, noir transparent

H 1100, Ø 160



E27 1x 40W



9 002759 985851

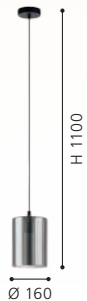



ARISCANI

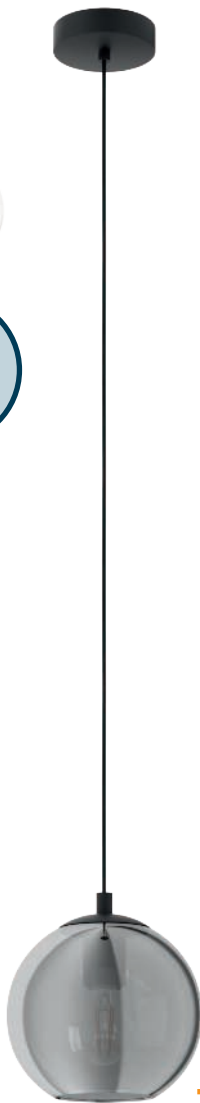

98651

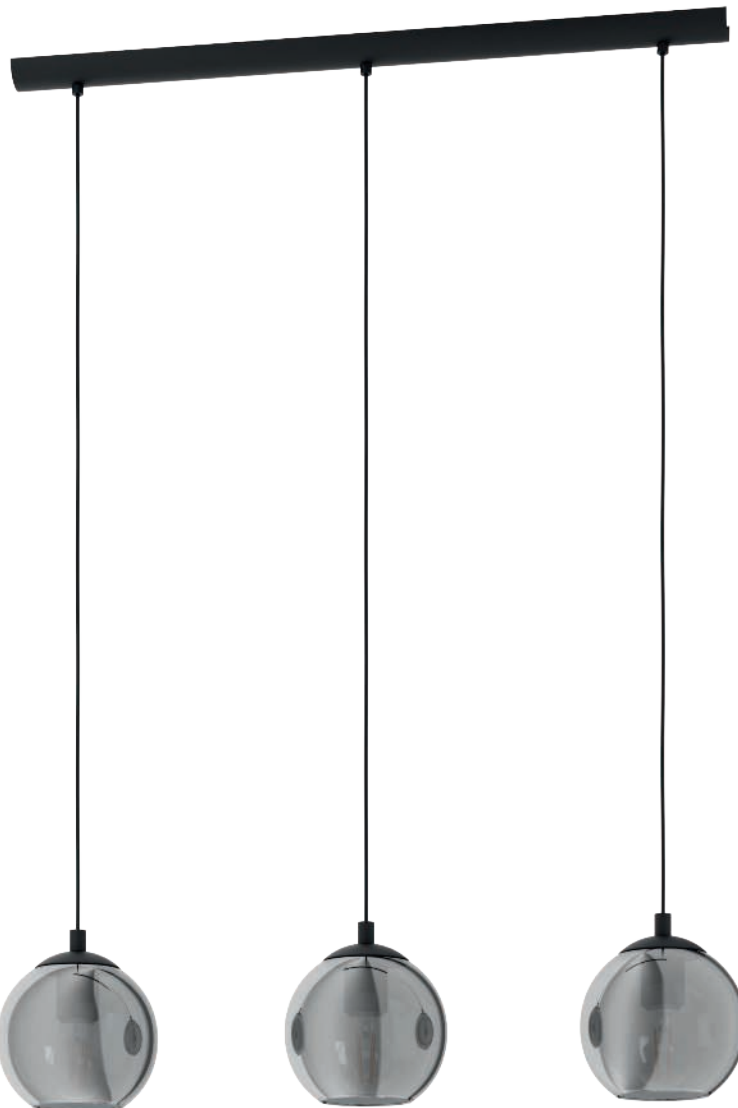

98652

98651 ARISCANI

pendant light; steel, black / glass vaporized, black-transparent
Hängeleuchte; Stahl, schwarz / Glas bedampft, schwarz-transparent
luminaire en suspension; acier, noir / verre vaporisé, noir transparent

H 1100, Ø 200



E27 1x 40W



9 002759 986513



98652 ARISCANI

pendant light; steel, black / glass vaporized, black-transparent
Hängeleuchte; Stahl, schwarz / Glas bedampft, schwarz-transparent
luminaire en suspension; acier, noir / verre vaporisé, noir transparent

L 765, B 165, H 1100



E27 3x 40W



9 002759 986520

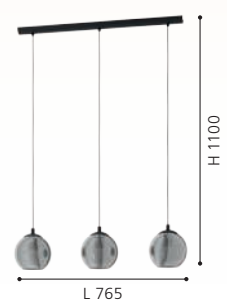



98653



98654

98653 ARISCANI

pendant light; steel, black / glass vaporized, black-transparent
 Hängeleuchte; Stahl, schwarz / Glas bedampft, schwarz-transparent
 luminaire en suspension; acier, noir / verre vaporisé, noir transparent

H 1100, Ø 425

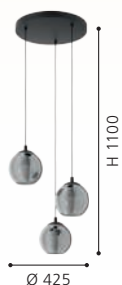

98654 ARISCANI

pendant light; steel, black / glass vaporized, black-transparent
 Hängeleuchte; Stahl, schwarz / Glas bedampft, schwarz-transparent
 luminaire en suspension; acier, noir / verre vaporisé, noir transparent

H 1700, Ø 655





96774 MURMILLO

pendant light; steel, chrome / smoked glass, black-transparent
 Hängeleuchte; Stahl, chrom / Rauchglas, schwarz-transparent
 luminaire en suspension; acier, chrome / verre fumé, noir transparent

L 770, B 170, H 1500



96773 MURMILLO

pendant light; steel, chrome / smoked glass, black-transparent
 Hängeleuchte; Stahl, chrom / Rauchglas, schwarz-transparent
 luminaire en suspension; acier, chrome / verre fumé, noir transparent

H 1500, Ø 170





96343

LED

96344

LED

96345

LED

96343 FARSALA

pendant light; steel, satin nickel / smoked glass, granules, black-transparent, clear

Hängeleuchte; Stahl, nickel-matt / Rauchglas, Granille, schwarz-transparent, klar

luminaire en suspension; acier, nickel mat / verre fumé, granité, noir transparent, transparent

H 1100, Ø 125



G9



1x 3W



1x

320lm



9 002759 963439

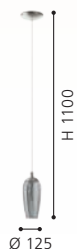

96344 FARSALA

pendant light; steel, satin nickel / smoked glass, granules, black-transparent, clear

Hängeleuchte; Stahl, nickel-matt / Rauchglas, Granille, schwarz-transparent, klar

luminaire en suspension; acier, nickel mat / verre fumé, granité, noir transparent, transparent

L 975, B 100, H 1100



G9



4x 3W



4x

320lm



9 002759 963446

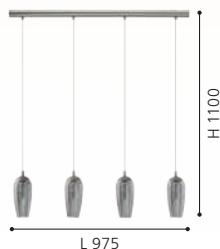

96345 FARSALA

pendant light; steel, satin nickel / smoked glass, granules, black-transparent, clear

Hängeleuchte; Stahl, nickel-matt / Rauchglas, Granille, schwarz-transparent, klar

luminaire en suspension; acier, nickel mat / verre fumé, granité, noir transparent, transparent

H 1500, Ø 350



G9



5x 3W



5x

320lm



9 002759 963453

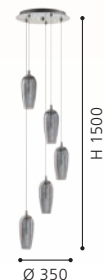



99371



98384 | 99371



98384

99371 MANTUNALLE 1

pendant light; steel, black / glass vaporized, black-transparent
 Hängeleuchte; Stahl, schwarz / Glas bedampft, schwarz-transparent
 luminaire en suspension; acier, noir / verre vaporisé, noir transparent

H 1100, Ø 200



98384 BELESER

pendant light; steel, black / glass vaporized, black-transparent
 Hängeleuchte; Stahl, schwarz / Glas bedampft, schwarz-transparent
 luminaire en suspension; acier, noir / verre vaporisé, noir transparent

L 905, B 205, H 1100



DESIGN
HIGHLIGHT
DETAIL





99366



99367 | 99368

99366 MANTUNALLE

pendant light; steel, black / glass, white
 Hängeleuchte; Stahl, schwarz / Glas, weiss
 luminaire en suspension; acier, noir / verre, blanc

H 1100, Ø 200



99368 MANTUNALLE

pendant light; steel, black / glass, white
 Hängeleuchte; Stahl, schwarz / Glas, weiss
 luminaire en suspension; acier, noir / verre, blanc

H 1100, Ø 620



99367 MANTUNALLE

pendant light; steel, black / glass, white
 Hängeleuchte; Stahl, schwarz / Glas, weiss
 luminaire en suspension; acier, noir / verre, blanc

L 1200, B 200, H 1100

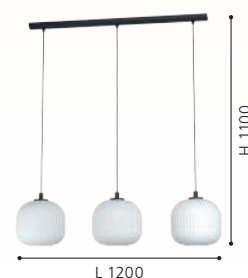

99367





98696



98697



98694 | 98695



98694

98696 SELVINO

pendant light; steel, satin nickel / glass vaporized, gold-coloured, brown

Hängeleuchte; Stahl, nickel-matt / Glas bedampft, goldfarben
luminaire en suspension; acier, nickel mat / verre vaporisé, couleur or

H 1100, Ø 100



E27 1x 15W



9 002759 986964



98697 SELVINO

pendant light; steel, satin nickel / glass vaporized, gold-coloured, brown

Hängeleuchte; Stahl, nickel-matt / Glas bedampft, goldfarben
luminaire en suspension; acier, nickel mat / verre vaporisé, couleur or

L 710, B 100, H 1100



E27 3x 15W



9 002759 986971

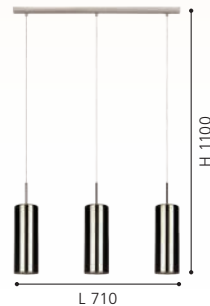

98694 SELVINO

pendant light; steel, satin nickel / glass vaporized, black-transparent

Hängeleuchte; Stahl, nickel-matt / Glas bedampft, schwarz-transparent
luminaire en suspension; acier, nickel mat / verre vaporisé, noir transparent

H 1100, Ø 100



E27 1x 15W



9 002759 986940





98696 | 98697 | 98698 | 98699

98695 SELVINO

pendant light; steel, satin nickel / glass vaporized, black-transparent

Hängeleuchte; Stahl, nickel-matt / Glas bedampft, schwarz-transparent

luminaire en suspension; acier, nickel mat / verre vaporisé, noir transparent

L 710, B 100, H 1100

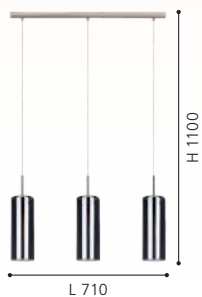

98698 SELVINO

pendant light; steel, satin nickel / glass vaporized, copper-coloured

Hängeleuchte; Stahl, nickel-matt / Glas bedampft, kupferfarben

luminaire en suspension; acier, nickel mat / verre vaporisé, cuivré

H 1100, Ø 100

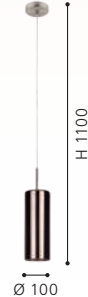

98699 SELVINO

pendant light; steel, satin nickel / glass vaporized, copper-coloured

Hängeleuchte; Stahl, nickel-matt / Glas bedampft, kupferfarben

luminaire en suspension; acier, nickel mat / verre vaporisé, cuivré

L 710, B 100, H 1100

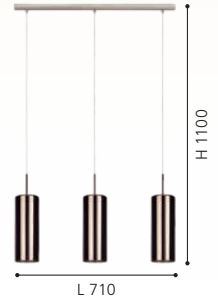

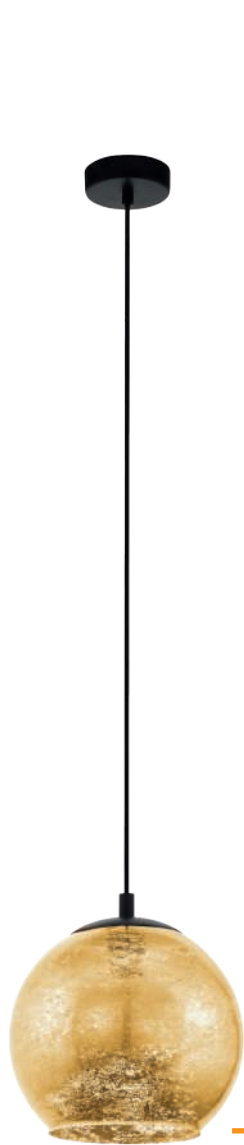

98523

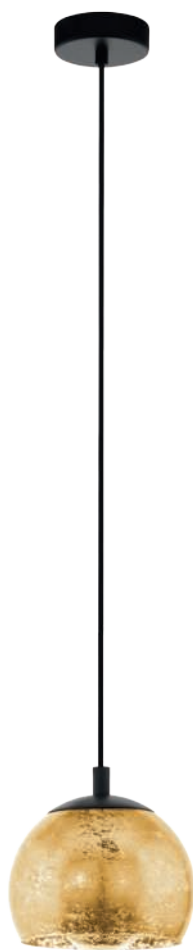

98524



98526

98523 ALBARACCIN

pendant light; steel, black / glass, gold-coloured, brown
 Hängeleuchte; Stahl, schwarz / Glas, goldfarben
 luminaire en suspension; acier, noir / verre, couleur or

H 1100, Ø 270



9 002759 985233



98524 ALBARACCIN

pendant light; steel, black / glass, gold-coloured, brown
 Hängeleuchte; Stahl, schwarz / Glas, goldfarben
 luminaire en suspension; acier, noir / verre, couleur or

H 1100, Ø 190



9 002759 985240



98526 ALBARACCIN

pendant light; steel, black / glass, gold-coloured, brown
 Hängeleuchte; Stahl, schwarz / Glas, goldfarben
 luminaire en suspension; acier, noir / verre, couleur or

H 1500, Ø 585



9 002759 985264





98525

98525 ALBARACCIN

pendant light; steel, black / glass, gold-coloured, brown
 Hängeleuchte; Stahl, schwarz / Glas, goldfarben
 luminaire en suspension; acier, noir / verre, couleur or

L 780, B 190, H 1100



E27



3x 40W



9 002759 985257





99654

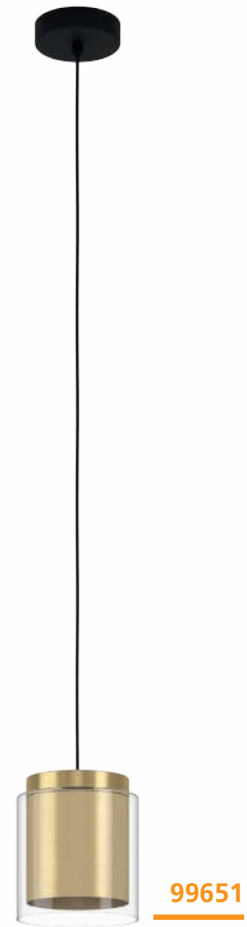

99651

99654 LAGUNITAS

pendant light; steel, black, brass, gold / glass, clear
 Hängeleuchte; Stahl, schwarz, messing, gold / Glas, klar
 luminaire en suspension; acier, noir, laiton, or / verre, transparent

L 910, B 150, H 1100



9 002759 996543



99651 LAGUNITAS

pendant light; steel, black, brass, gold / glass, clear
 Hängeleuchte; Stahl, schwarz, messing, gold / Glas, klar
 luminaire en suspension; acier, noir, laiton, or / verre, transparent

H 1100, Ø 150



9 002759 996512





99628

LED

99629

LED



99628 CERASELLA

pendant light; steel, brushed brass / glass, clear
 Hängeleuchte; Stahl, messing-gebürstet / Glas, klar
 luminaire en suspension; acier, laiton brossé / verre, transparent

H 1100, Ø 200

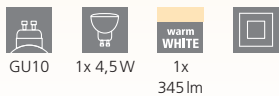

99629 CERASELLA

pendant light; steel, brushed brass / glass, clear
 Hängeleuchte; Stahl, messing-gebürstet / Glas, klar
 luminaire en suspension; acier, laiton brossé / verre, transparent

L 900, B 200, H 1100

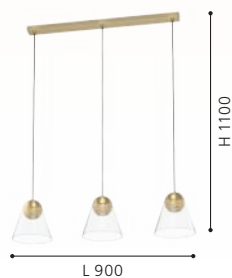

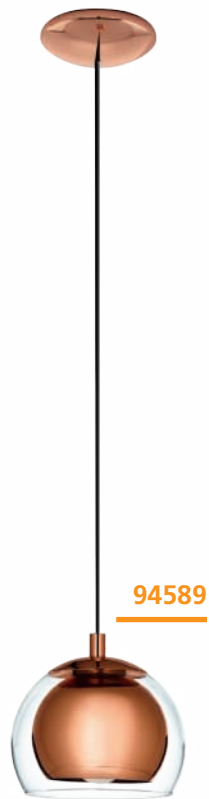

94589

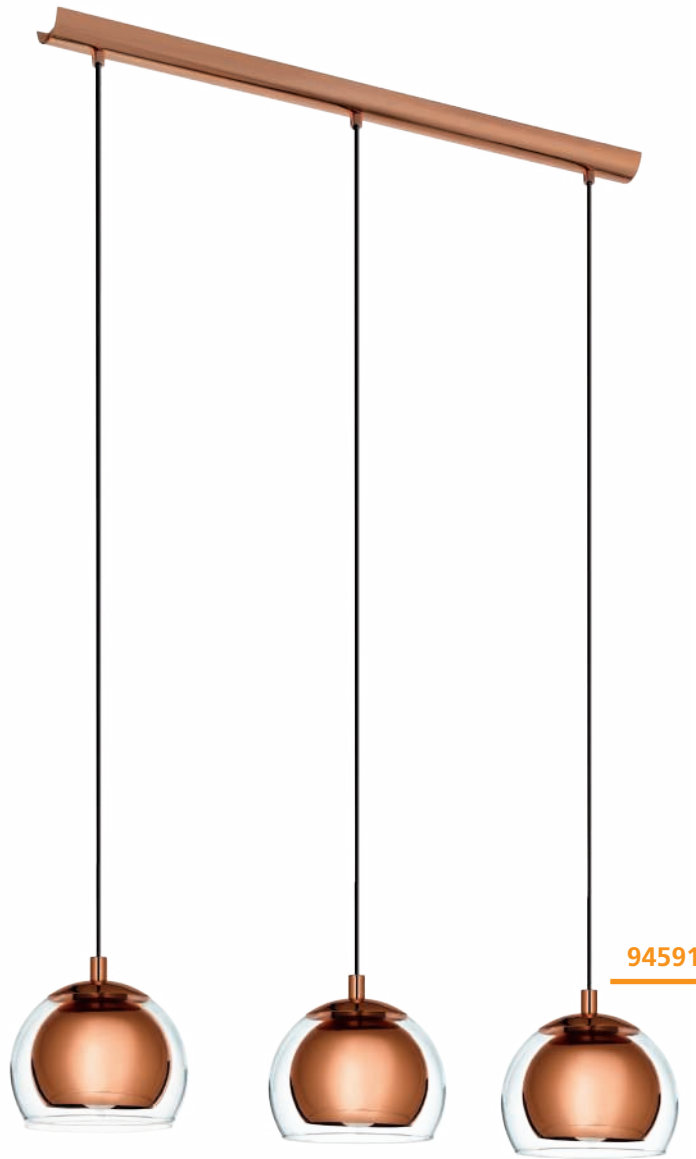

94591

94589 ROCAMAR

pendant light; steel, copper / glass, clear
 Hängeleuchte; Stahl, kupfer / Glas, klar
 luminaire en suspension; acier, cuivre / verre, transparent

H 1100, Ø 190



9 002759 945893

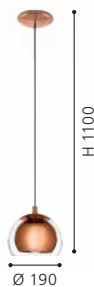

94591 ROCAMAR

pendant light; steel, copper / glass, clear
 Hängeleuchte; Stahl, kupfer / Glas, klar
 luminaire en suspension; acier, cuivre / verre, transparent

L 780, B 190, H 1100



9 002759 945916

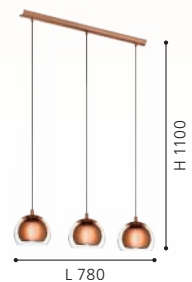



98595

98595 ROCAMAR 1

pendant light; steel, copper / glass, clear
 Hängeleuchte; Stahl, kupfer / Glas, klar
 luminaire en suspension; acier, cuivre / verre, transparent

H 1500, Ø 585

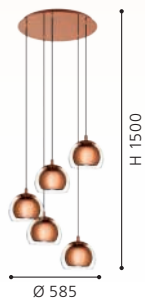

93836 CORETTO

pendant light; steel, brushed copper
 Hängeleuchte; Stahl, kupfer-gebürstet
 luminaire en suspension; acier, cuivre brossé

H 1100, Ø 170

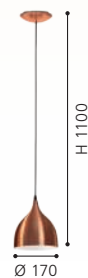

93836

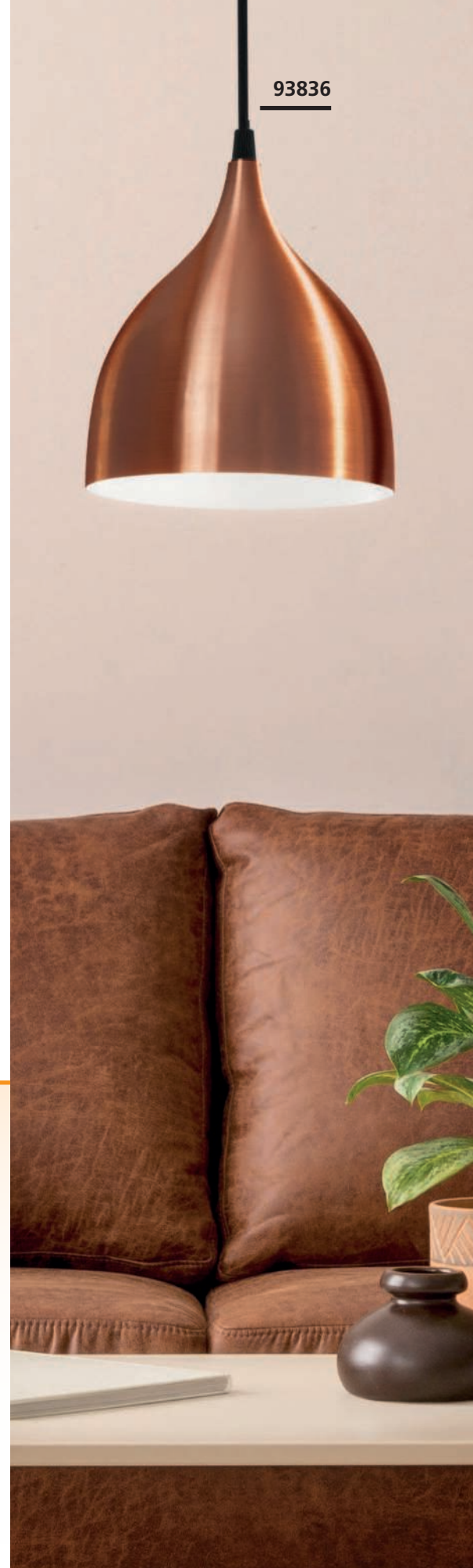

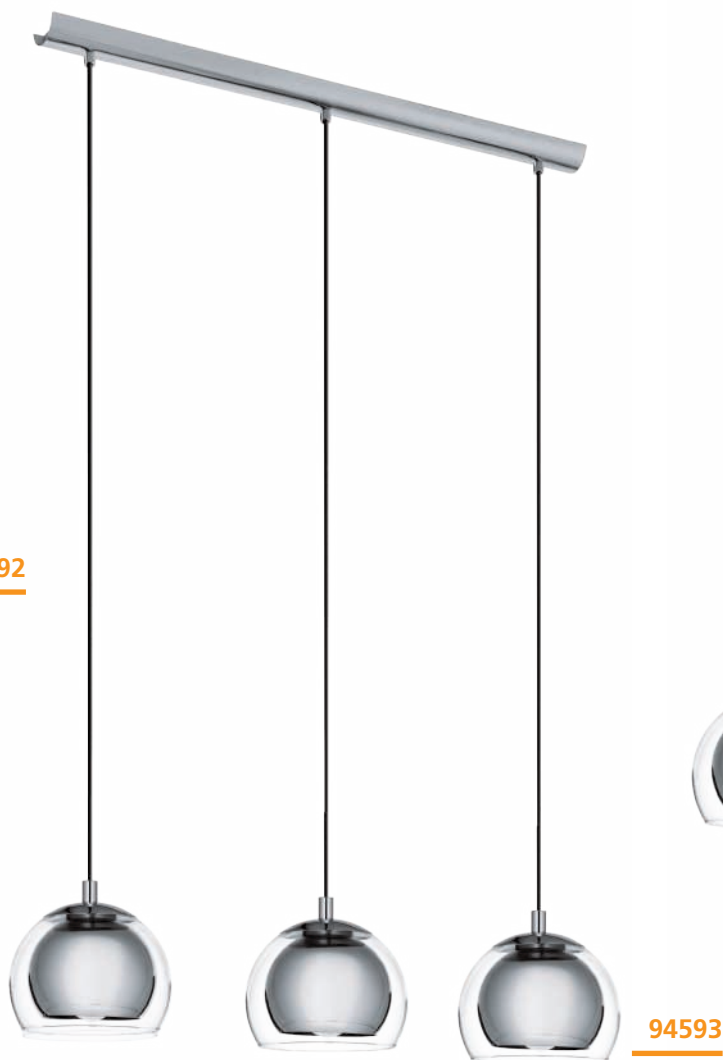
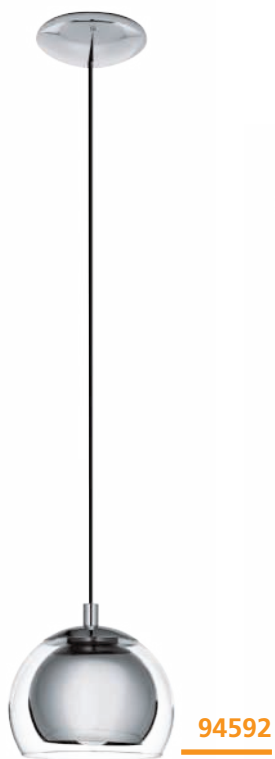

94592 ROCAMAR

pendant light; steel, chrome / glass, clear
 Hängeleuchte; Stahl, chrom / Glas, klar
 luminaire en suspension; acier, chrome / verre, transparent

H 1100, Ø 190



9 002759 945923



94593 ROCAMAR

pendant light; steel, chrome / glass, clear
 Hängeleuchte; Stahl, chrom / Glas, klar
 luminaire en suspension; acier, chrome / verre, transparent

L 780, B 190, H 1100



9 002759 945930



98596 ROCAMAR 1

pendant light; steel, chrome / glass, clear
 Hängeleuchte; Stahl, chrom / Glas, klar
 luminaire en suspension; acier, chrome / verre, transparent

H 1500, Ø 585



9 002759 985967





94378



94377



EGLO RECOMMENDS
110033
LONCINO 1

94378 LONCINO 1

pendant light; steel, chrome / glass, satin glass, clear, white
Hängeleuchte; Stahl, chrom / Glas, Glas satiniert, klar, weiss
luminaire en suspension; acier, chrome / verre, verre satiné, transparent, blanc

L 745, B 150, H 1100



9 002759 943783



94377 LONCINO 1

pendant light; steel, chrome / glass, satin glass, clear, white
Hängeleuchte; Stahl, chrom / Glas, Glas satiniert, klar, weiss
luminaire en suspension; acier, chrome / verre, verre satiné, transparent, blanc

L 150, B 150, H 1100



9 002759 943776





96528

LED

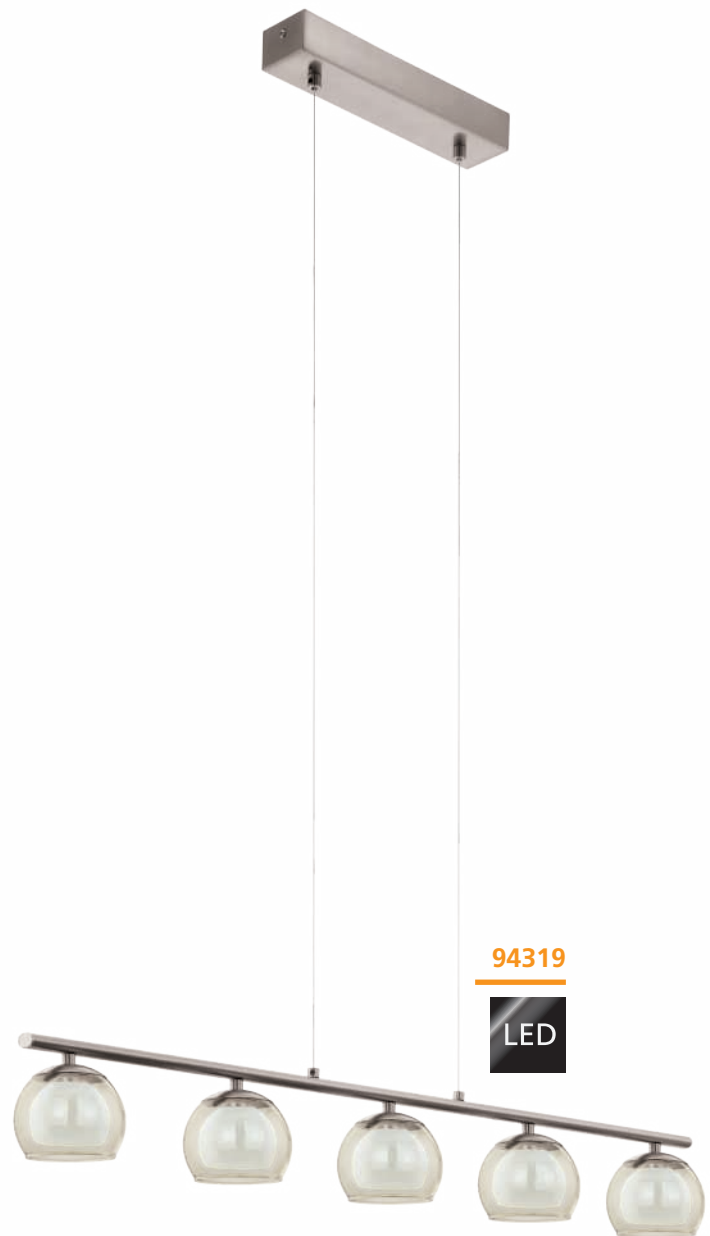

94319

LED

96528 ALEANDRO 1

pendant light; steel, chrome / matte-opal glass, white
 Hängeleuchte; Stahl, chrom / Glas opal-matt, weiss
 luminaire en suspension; acier, chrome / verre opale mat, blanc

L 800, B 120, H 860 - 1550



4x 4,5W 2000lm

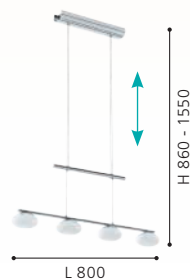

94319 ROMAGNESE

pendant light; steel, satin nickel / glass, satin glass, amber, white
 Hängeleuchte; Stahl, nickel-matt / Glas, Glas satiniert, ambre, weiss
 luminaire en suspension; acier, nickel mat / verre, verre satiné, ambre, blanc

L 900, B 105, H 1100



5x 3,3W 1700lm

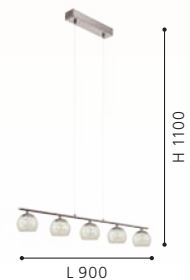



97793



97793 VALLASPRA

pendant light; steel, champagne / matte-opal glass, white
Hängeleuchte; Stahl, champagner / Glas opal-matt, weiss
luminaire en suspension; acier, champagne / verre opale mat, blanc

L 910, B 165, H 1100

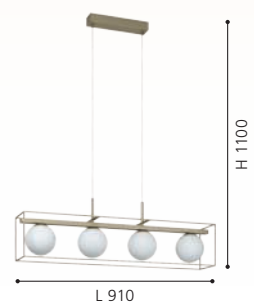
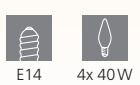

97587 BATISTA 3

pendant light; steel, satin nickel / glass wiping technique, white
Hängeleuchte; Stahl, nickel-matt / Glas Wischtechnik, weiss
luminaire en suspension; acier, nickel mat / technique de verre essuyé, blanc

L 1020, B 120, H 1100

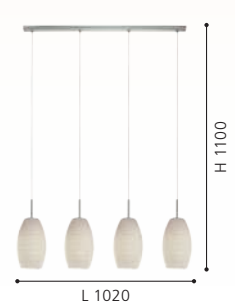



92762



92761

92762 BOLSANO

pendant light; steel, chrome / satin glass, glass, white, clear
 Hängeleuchte; Stahl, chrom / Glas satiniert, Glas, weiss, klar
 luminaire en suspension; acier, chrome / verre satiné, verre, blanc, transparent

H 1300, Ø 505



92761 BOLSANO

pendant light; steel, chrome / satin glass, glass, white, clear
 Hängeleuchte; Stahl, chrom / Glas satiniert, Glas, weiss, klar
 luminaire en suspension; acier, chrome / verre satiné, verre, blanc, transparent

H 1300, Ø 200





EGLO
RECOMMENDS
110003
CLEMENTE

95286



95287

95286 CLEMENTE

pendant light; steel, chrome / brilliant glass, clear
Hängeleuchte; Stahl, chrom / Brillantglas, klar
luminaire en suspension; acier, chrome / verre brillant, transparent

H 1100, Ø 350



9 002759 952860



95287 CLEMENTE

pendant light; steel, chrome / brilliant glass, clear
Hängeleuchte; Stahl, chrom / Brillantglas, klar
luminaire en suspension; acier, chrome / verre brillant, transparent

H 1100, Ø 540



9 002759 952877

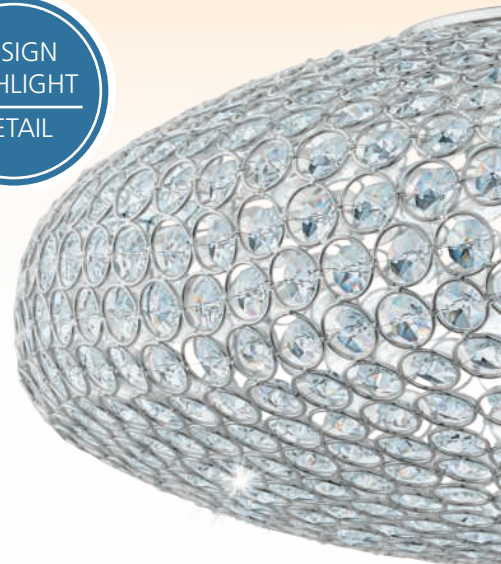



93625

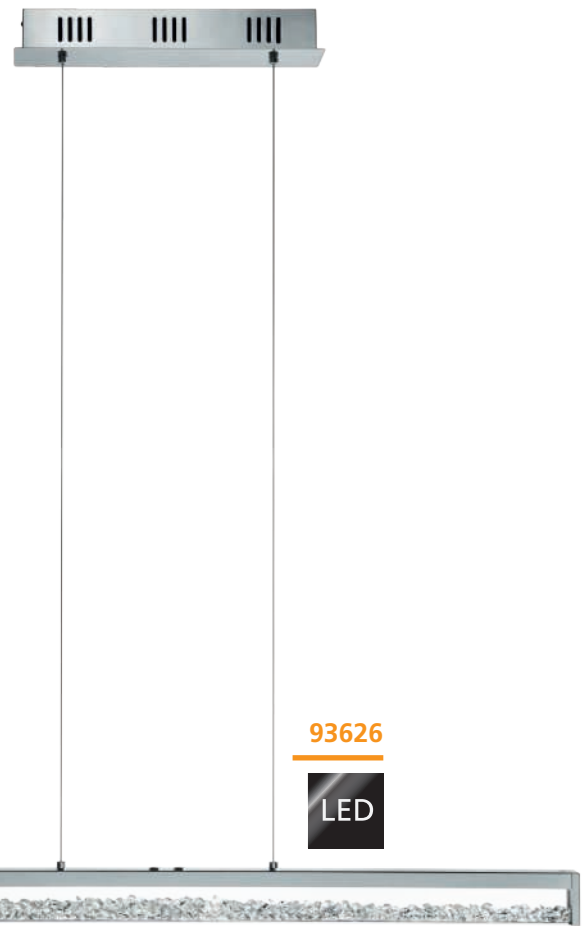

93626

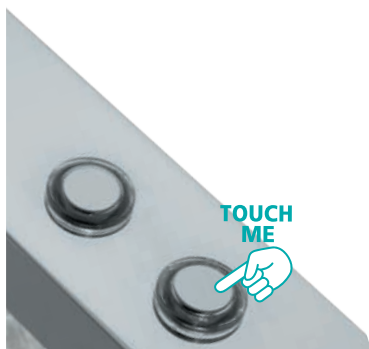

TOUCH ME



see the tunable white video
 unser Tunable White Video
 notre video de blanc réglable

CARDITO 1



Warm White 2700K Neutral White Cold White 5000K

These luminaires can be switched on and off by touching the specially designed "Touch Me" part of the fixture. Features via touch-dimmer:

- > light colour adjustable between 2700K - 5000K
- > dimmable 10% - 100%

Diese Leuchten können ein und ausgeschaltet werden, indem man sie an den dafür vorgesehenen „Touch Me“ Bereichen berührt. Per Touch-Dimmer verfügen diese Leuchten über folgende Funktionen:

- > Lichtfarbe einstellbar im Bereich 2700K bis 5000K
- > dimmbar 10% bis 100%

Ces luminaires peuvent être éteints et allumés simplement en touchant la partie spécialement conçue pour «Touch Me» du luminaire. Fonctions du gradateur «touch»:

- > couleur lumineuse réglable de 2700K - 5000K
- > réglable en luminosité 10% - 100%

93625 CARDITO 1

pendant light; aluminium, steel, chrome / glass, brilliant glass, clear

Hängeleuchte; Alu, Stahl, chrom / Glas, Brillantglas, klar

luminaire en suspension; aluminium, acier, chrome / verre, verre brillant, transparent

L 700, B 80, H 750 - 1300



4x 6W



2280lm



9 002759 936259

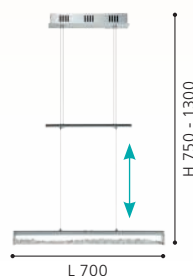

93626 CARDITO 1

pendant light; aluminium, steel, chrome / glass, brilliant glass, clear

Hängeleuchte; Alu, Stahl, chrom / Glas, Brillantglas, klar

luminaire en suspension; aluminium, acier, chrome / verre, verre brillant, transparent

L 1000, B 80, H 1100



6x 6W



3420lm



9 002759 936266

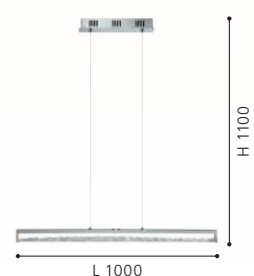

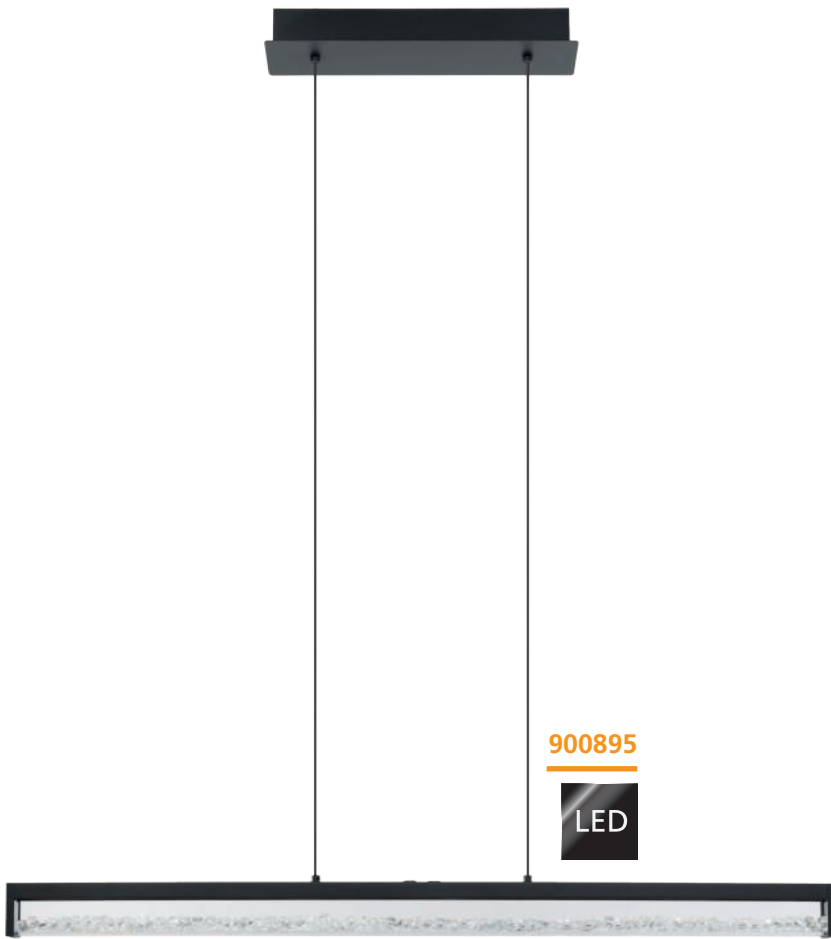

900895

LED



31667

LED

900895 CARDITO 1

pendant light; aluminium, steel, black / glass, brilliant glass, clear
 Hängeleuchte; Alu, Stahl, schwarz / Glas, Brillantglas, klar
 luminaire en suspension; aluminium, acier, noir / verre, verre
 brillant, transparent

L 1000, B 80, H 1100



6x 6W 3420lm



9 008606 267941

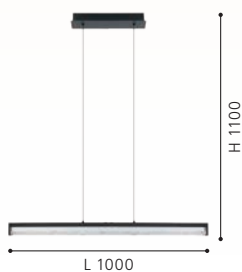

31667 VARRAZO

pendant light; steel, chrome / brilliant glass, clear
 Hängeleuchte; Stahl, chrom / Brillantglas, klar
 luminaire en suspension; acier, chrome / verre brillant, trans-
 parent

H 1200, Ø 550



29W 4300lm



9 002759 316679

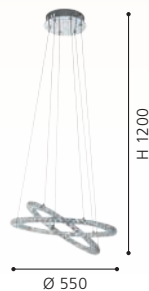

MONTEFIO 1

These luminaires come with high quality brilliant glass.

Diese Leuchten sind mit hochwertigem Brillantglas ausgestattet.

Ces lumières sont fabriquées avec une haute qualité Equipé de verre brillant.



93073



93709

LED

93073 LUBERIO

pendant light; steel, chrome / glass, aluminium, clear, aluminium
Hängeleuchte; Stahl, chrom / Glas, Alu, klar, alu
luminaire en suspension; acier, chrome / verre, aluminium, transparent, aluminium

H 1100, Ø 250



E27



1x 60W



9 002759 930738



93709 MONTEFIO 1

pendant light; steel, chrome / glass, brilliant glass, white, clear
Hängeleuchte; Stahl, chrom / Glas, Brillantglas, weiss, klar
luminaire en suspension; acier, chrome / verre, verre brillant, blanc, transparent

H 1100, Ø 400



LED



warm WHITE



3x 5W



1500lm



9 002759 937096

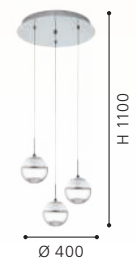



93708

LED



93784

LED

93708 MONTEFIO 1

pendant light; steel, chrome / glass, brilliant glass, white, clear
 Hängeleuchte; Stahl, chrom / Glas, Brillantglas, weiss, klar
 luminaire en suspension; acier, chrome / verre, verre brillant,
 blanc, transparent

H 1100, Ø 140



1x 5W 480lm



9 002759 937089



93784 MONTEFIO 1

pendant light; steel, chrome / glass, brilliant glass, white, clear
 Hängeleuchte; Stahl, chrom / Glas, Brillantglas, weiss, klar
 luminaire en suspension; acier, chrome / verre, verre brillant,
 blanc, transparent

L 870, B 140, H 1100



3x 5W 1500lm



9 002759 937843





98628



98629



MIOGLIA 1

98628 MIOGLIA 1

pendant light; steel, chrome / plastic, white granules, clear
 Hängeleuchte; Stahl, chrom / Kunststoff, granille weiss, klar
 luminaire en suspension; acier, chrome / plastique, blanc granille, transparent

L 975, B 150, H 1100



E14



4x 25W



9 002759 986285

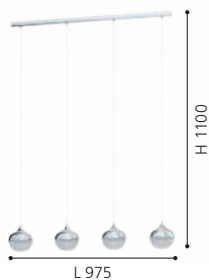

L 975

H 1100

98629 MIOGLIA 1

pendant light; steel, chrome / plastic, white granules, clear
 Hängeleuchte; Stahl, chrom / Kunststoff, granille weiss, klar
 luminaire en suspension; acier, chrome / plastique, blanc granille, transparent

H 1500, Ø 540



E14



5x 25W



9 002759 986292



Ø 540

H 1500

95913 CONESSA

pendant light; steel, chrome / plastic, clear
 Hängeleuchte; Stahl, chrom / Kunststoff, klar
 luminaire en suspension; acier, chrome / plastique, transparent

H 1100, Ø 290



GU10



3x 3W



warm WHITE

3x 250lm



9 002759 959135



INCL.



Ø 290

H 1100



95913

LED

95912

LED





95914

LED

95912 CONESSA

pendant light; steel, chrome / plastic, clear
 Hängeleuchte; Stahl, chrom / Kunststoff, klar
 luminaire en suspension; acier, chrome / plastique, transparent

L 1010, B 150, H 1100

-  GU10
-  4x 3W
-  warm WHITE
4x 250lm



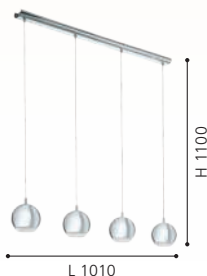

9 002759 959128



95914 CONESSA

pendant light; steel, chrome / plastic, clear
 Hängeleuchte; Stahl, chrom / Kunststoff, klar
 luminaire en suspension; acier, chrome / plastique, transparent

H 1700, Ø 580

-  GU10
-  10x 3W
-  warm WHITE
10x 250lm



9 002759 959142

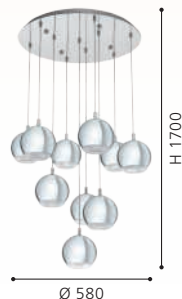



94244

LED

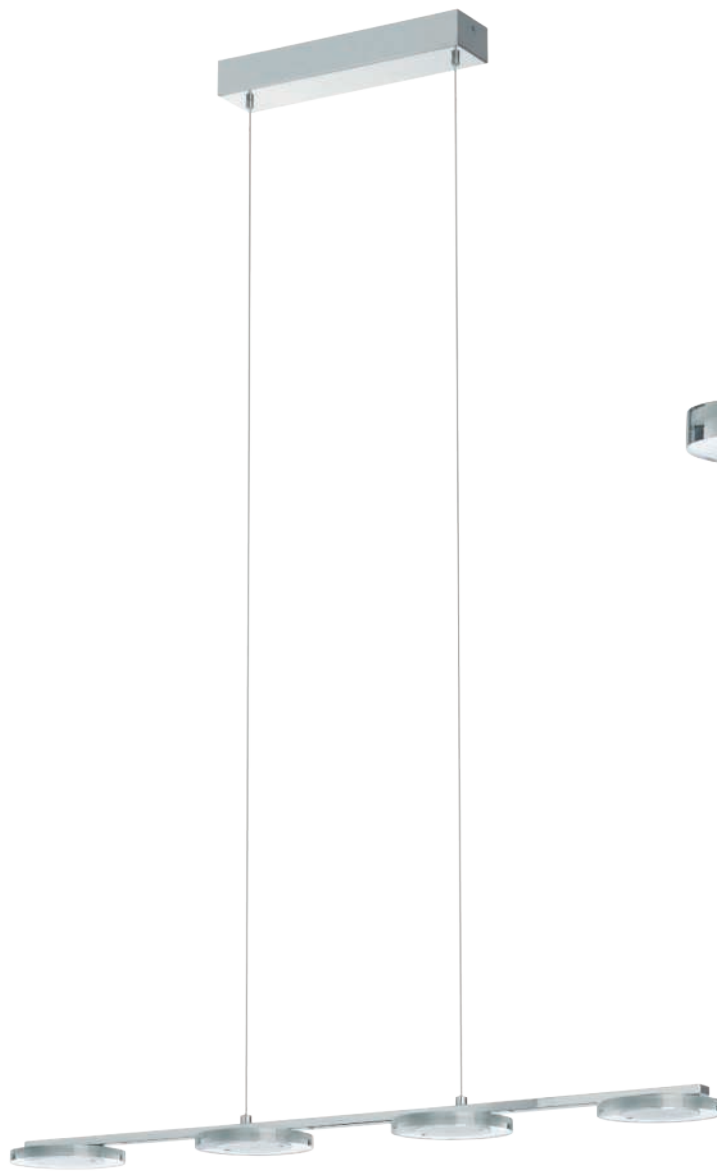

94245



94244 CARTAMA

pendant light; steel, chrome / plastic, clear, satin finish
 Hängeleuchte; Stahl, chrom / Kunststoff, klar, satiniert
 luminaire en suspension; acier, chrome / plastique, transparent, satiné

L 780, B 90, H 1100



4x 4,6W 2200lm

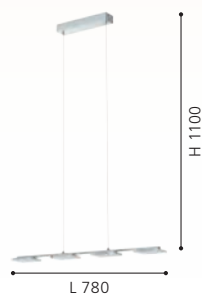

94245 CARTAMA

pendant light; steel, chrome / plastic, clear, satin finish
 Hängeleuchte; Stahl, chrom / Kunststoff, klar, satiniert
 luminaire en suspension; acier, chrome / plastique, transparent, satiné

L 775, B 115, H 1100



4x 4,6W 2200lm

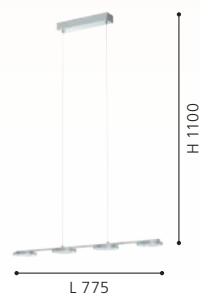



97366

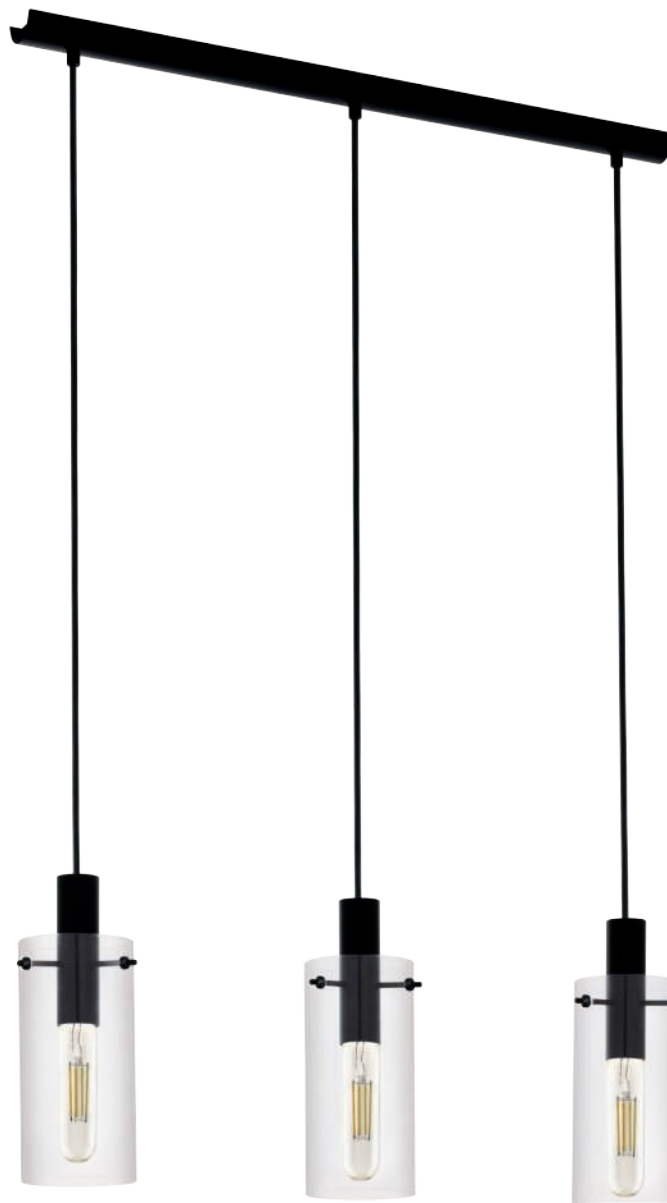

97367

97366 MONTEFINO

pendant light; steel, black / glass, clear
 Hängeleuchte; Stahl, schwarz / Glas, klar
 luminaire en suspension; acier, noir / verre, transparent

H 1100, Ø 110



E27 1x 60W



9 002759 973667



97367 MONTEFINO

pendant light; steel, black / glass, clear
 Hängeleuchte; Stahl, schwarz / Glas, klar
 luminaire en suspension; acier, noir / verre, transparent

L 730, B 110, H 1100



E27 3x 60W



9 002759 973674



97368 MONTEFINO

pendant light; steel, black / glass, clear
 Hängeleuchte; Stahl, schwarz / Glas, klar
 luminaire en suspension; acier, noir / verre, transparent

H 1500, Ø 350



E27 5x 60W



9 002759 973681





97368



98056



98058

98056 CORTENOVA

pendant light; steel, black
Hängeleuchte; Stahl, schwarz
luminaire en suspension; acier, noir

H 1100, Ø 105



E27 1x 60W



9 002759 980566



98058 CORTENOVA

pendant light; steel, black
Hängeleuchte; Stahl, schwarz
luminaire en suspension; acier, noir

H 1500, Ø 350



E27 5x 60W



9 002759 980580



98057 CORTENOVA

pendant light; steel, black
Hängeleuchte; Stahl, schwarz
luminaire en suspension; acier, noir

L 840, B 60, H 1100



E27 4x 60W



9 002759 980573





98057



900799



900798



900801



900799 POZUETA 1

pendant light; steel, brushed brass
Hängeleuchte; Stahl, messing-gebürstet
luminaire en suspension; acier, laiton brossé

H 1100, Ø 65



E27 1x 40W



9 008606 270248

900798 POZUETA 1

pendant light; steel, white
Hängeleuchte; Stahl, weiss
luminaire en suspension; acier, blanc

H 1100, Ø 65



E27 1x 40W



9 008606 270231

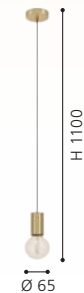

900801 POZUETA 1

pendant light; steel, wood, black, brown
Hängeleuchte; Stahl, Holz, schwarz, braun
luminaire en suspension; acier, bois, noir, marron

H 1100, Ø 65



E27 1x 40W



9 008606 270255

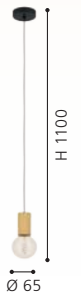
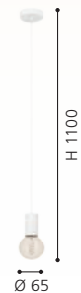



98661





98663



98662



POZUETA

98661 POZUETA

pendant light; steel, black
Hängeleuchte; Stahl, schwarz
luminaire en suspension; acier, noir

H 1100, Ø 125



E27 1x 40W



9 002759 986612



98663 POZUETA

pendant light; steel, black
Hängeleuchte; Stahl, schwarz
luminaire en suspension; acier, noir

H 1500, Ø 330



E27 3x 40W



9 002759 986636



98662 POZUETA

pendant light; steel, black
Hängeleuchte; Stahl, schwarz
luminaire en suspension; acier, noir

L 840, B 65, H 1100



E27 3x 40W



9 002759 986629





98346



98347

98346 BOCADELLA

pendant light; steel, black
 Hängeleuchte; Stahl, schwarz
 luminaire en suspension; acier, noir

H 1100, Ø 640



E27



9x 60W



9 002759 983468

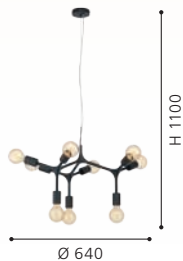

98347 BOCADELLA

pendant light; steel, black
 Hängeleuchte; Stahl, schwarz
 luminaire en suspension; acier, noir

H 1100, Ø 920



E27



12x 60W



9 002759 983475

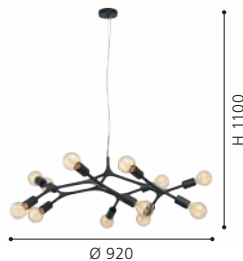

98909 MEZZANA

pendant light; steel, black
 Hängeleuchte; Stahl, schwarz
 luminaire en suspension; acier, noir

L 650, B 650, H 1100



E27



8x 40W



9 002759 989095

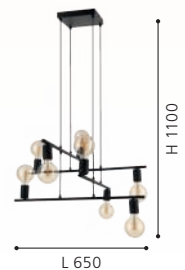



98909



98017



98016



99811

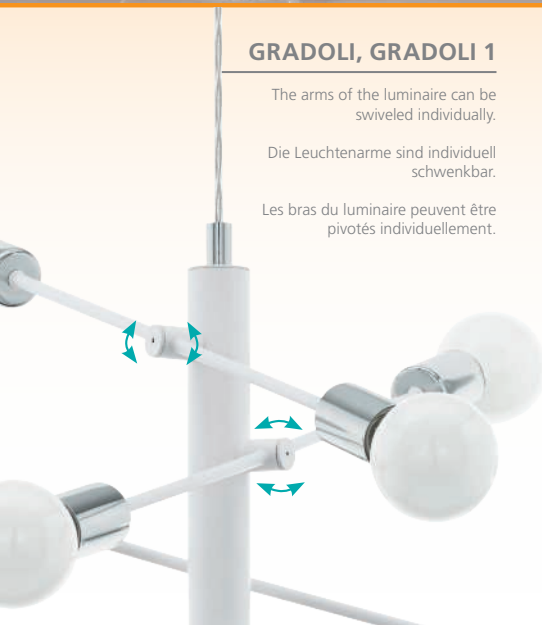

GRADOLI, GRADOLI 1

The arms of the luminaire can be swiveled individually.

Die Leuchtenarme sind individuell schwenkbar.

Les bras du luminaire peuvent être pivotés individuellement.

98017 GRADOLI

pendant light; steel, white, chrome
Hängeleuchte; Stahl, weiss, chrom
luminaire en suspension; acier, blanc, chrome

H 1100, Ø 710

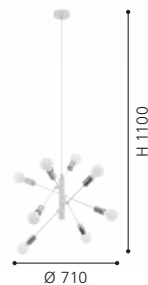

98016 GRADOLI

pendant light; steel, white, chrome
Hängeleuchte; Stahl, weiss, chrom
luminaire en suspension; acier, blanc, chrome

H 1100, Ø 550

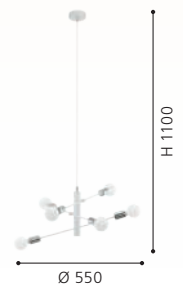
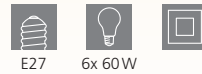



98835



MANIZALES



98834

99811 GRADOLI 1

pendant light; steel, brushed brass
Hängeleuchte; Stahl, messing-gebürstet
luminaire en suspension; acier, laiton brossé

H 1100, Ø 710

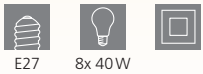

E27 8x 40W



9 002759 998110

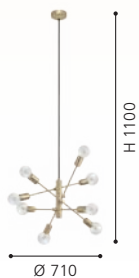

98835 MANIZALES

pendant light; steel, brushed brass
Hängeleuchte; Stahl, messing-gebürstet
luminaire en suspension; acier, laiton brossé

L 1010, B 50, H 1100



E27 3x 40W



9 002759 988357

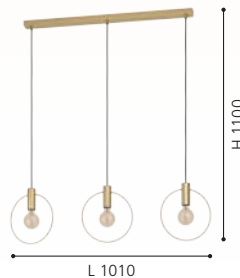

98834 MANIZALES

pendant light; steel, brushed brass
Hängeleuchte; Stahl, messing-gebürstet
luminaire en suspension; acier, laiton brossé

L 250, B 105, H 1100



E27 1x 40W



9 002759 988340

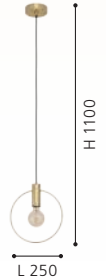



900399



97733

LED

900399 CUMIOLE

pendant light; steel, gold-coloured
 Hängeleuchte; Stahl, goldfarben
 luminaire en suspension; acier, or

L 780, B 150, H 1100



E27



3x 40W



9 008606 243754

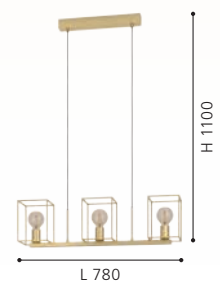



97734



98858

97733 MONTEBALDO

pendant light; steel, black, gold
Hängeleuchte; Stahl, schwarz, gold
luminaire en suspension; acier, noir, or

L 100, B 100, H 1100

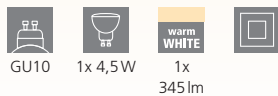

97734 MONTEBALDO

pendant light; steel, black, gold
Hängeleuchte; Stahl, schwarz, gold
luminaire en suspension; acier, noir, or

L 850, B 100, H 1100



98858 BITACHITO

pendant light; steel, black, brass
Hängeleuchte; Stahl, schwarz, messing
luminaire en suspension; acier, noir, laiton

L 930, B 55, H 1100

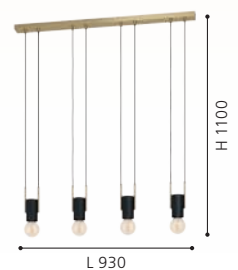

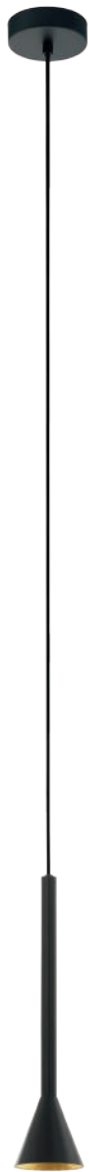

97604

LED

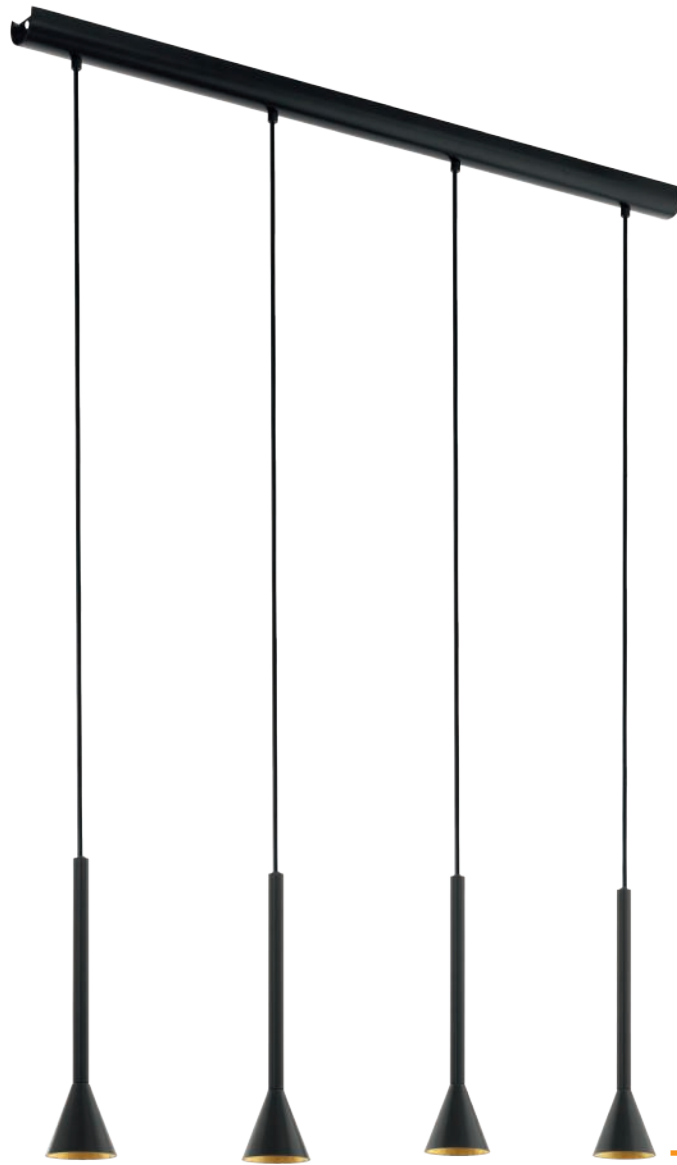

97605

LED



97604 CORTADERAS

pendant light; steel, black, gold
Hängeleuchte; Stahl, schwarz, gold
luminaire en suspension; acier, noir, or

H 1500, Ø 95



GU10



1x 4,8W



1x
400lm



9 002759 976040



97605 CORTADERAS

pendant light; steel, black, gold
Hängeleuchte; Stahl, schwarz, gold
luminaire en suspension; acier, noir, or

L 1130, B 85, H 1500



GU10



4x 4,8W



4x
400lm



9 002759 976057





900977



900976



900975

900975, 900976, 900977



These luminaires have a mains plug. The cable routing (total cable length 5.5 m) of these luminaires is individual, the fastening clips required for this are included in the scope of delivery.

Diese Leuchten haben einen Netzstecker. Die Kabelführung (Gesamtkabellänge 5,5 m) dieser Leuchten ist individuell, die dafür benötigten Befestigungsclips sind im Lieferumfang enthalten.

Ces luminaires sont équipés d'une fiche secteur. Le guidage du câble (longueur totale du câble : 5,5 m) de ces luminaires est individuel, les clips de fixation nécessaires sont compris dans la livraison.

900977 RONDO 3

pendant light; steel, plastic, black / matte-opal glass, white
Hängeleuchte; Stahl, Kunststoff, schwarz / Glas opal-matt, weiss
luminaire en suspension; acier, plastique, noir / verre opale mat, blanc

L 200, H 1420, A 400

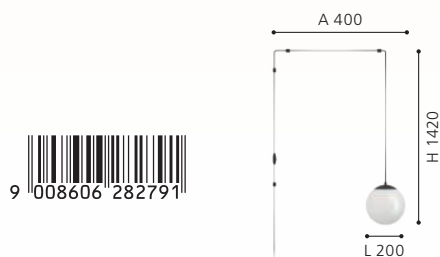

900976 PINETINA

pendant light; steel, black
Hängeleuchte; Stahl, schwarz
luminaire en suspension; acier, noir

L 45, H 1280, A 400

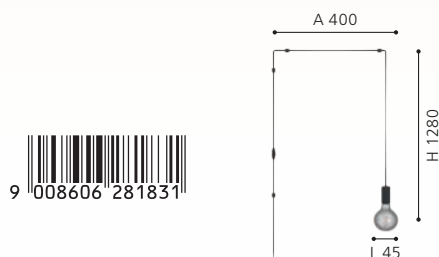

900975 NARICES

pendant light; steel, brushed brass, black
Hängeleuchte; Stahl, messing-gebürstet, schwarz
luminaire en suspension; acier, laiton brossé, noir

L 180, H 1420, A 400

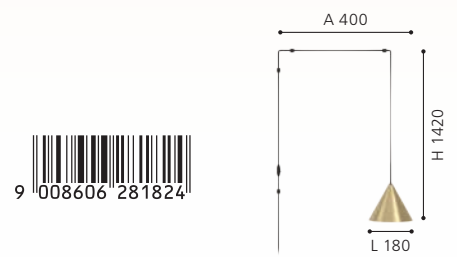
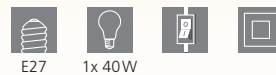



900401

LED



900402

LED

900401 SARONA

pendant light; steel, black, gold
 Hängeleuchte; Stahl, schwarz, gold
 luminaire en suspension; acier, noir, or

H 1100, Ø 210

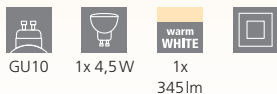

GU10 1x 4,5W 1x 345lm



9 008606 243761



900402 SARONA

pendant light; steel, black, gold
 Hängeleuchte; Stahl, schwarz, gold
 luminaire en suspension; acier, noir, or

L 910, B 50, H 1100

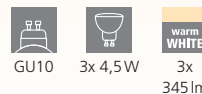

GU10 3x 4,5W 3x 345lm



Ø 210



9 008606 243778

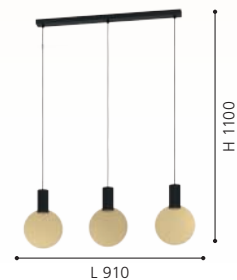

L 910



99531



99532

99531 LOBATIA

pendant light; steel, wood, black / terrazzo, grey, white
 Hängeleuchte; Stahl, Holz, schwarz / Terrazzo, grau, weiss
 luminaire en suspension; acier, bois, noir / terrazzo, gris, blanc

H 1100, Ø 105



9 002759 995317

99532 LOBATIA

pendant light; steel, wood, black / terrazzo, grey, white
 Hängeleuchte; Stahl, Holz, schwarz / Terrazzo, grau, weiss
 luminaire en suspension; acier, bois, noir / terrazzo, gris, blanc

L 925, B 55, H 1100



9 002759 995324

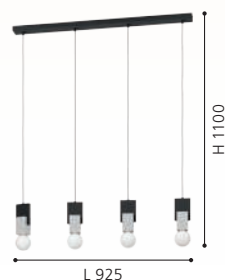



95522



95523

95522 SILVARES

pendant light; steel, grey / concrete, grey
Hängeleuchte; Stahl, grau / Beton, grau
luminaire en suspension; acier, gris / béton, gris

H 1100, Ø 110

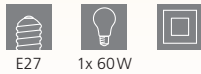

95523 SILVARES

pendant light; steel, grey / concrete, grey
Hängeleuchte; Stahl, grau / Beton, grau
luminaire en suspension; acier, gris / béton, gris

H 1500, Ø 250





95525



95526

95525 TAREGA

pendant light; steel, grey / wood, concrete, brown, grey
 Hängeleuchte; Stahl, grau / Holz, Beton, braun, grau
 luminaire en suspension; acier, gris / bois, béton, marron, gris

H 1100, Ø 150



95526 TAREGA

pendant light; steel, grey / wood, concrete, brown, grey
 Hängeleuchte; Stahl, grau / Holz, Beton, braun, grau
 luminaire en suspension; acier, gris / bois, béton, marron, gris

H 1500, Ø 250





99464



GATUELA 1

The lamp heads can be swiveled.
Die Leuchtenköpfe sind schwenkbar.
Les têtes de lampe peuvent être pivotées.

99464 GATUELA 1

pendant light; steel, black
Hängeleuchte; Stahl, schwarz
luminaire en suspension; acier, noir

L 1160, B 190, H 1100



E14



6x 25W



9 002759 994648

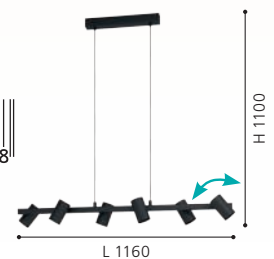

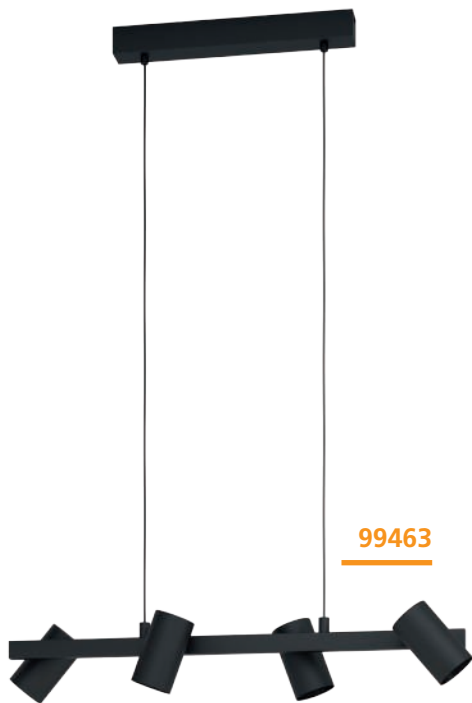

99463

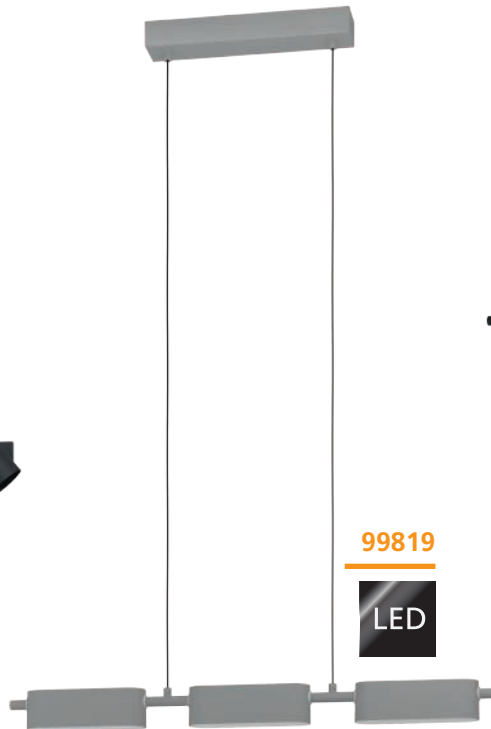

99819

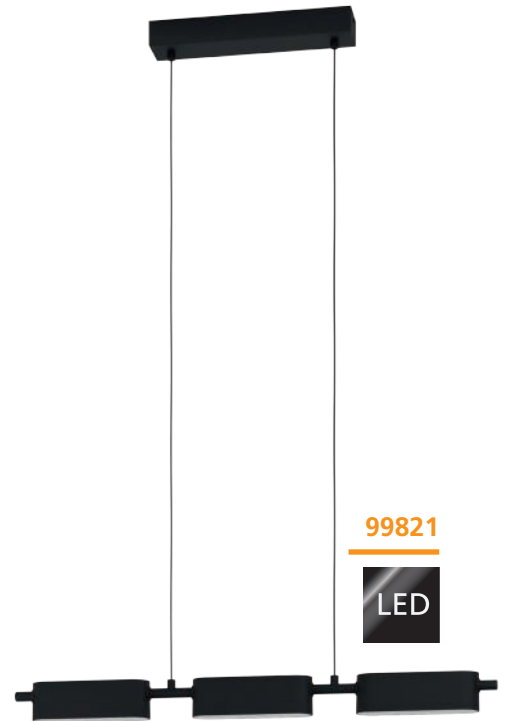

99821

LED

99463 GATUELA 1

pendant light; steel, black
Hängeleuchte; Stahl, schwarz
luminaire en suspension; acier, noir

L 760, B 190, H 1100



E14 4x 25W



9 002759 994631

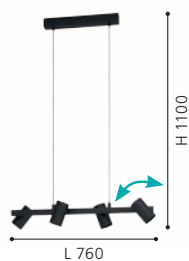

99819 ROVIRA

pendant light; aluminium, steel, silver / plastic, white
Hängeleuchte; Alu, Stahl, silber / Kunststoff, weiss
luminaire en suspension; aluminium, acier, argent / plastique, blanc

L 770, B 50, H 1100



LED warm WHITE 3x 6,7W 2400lm



9 002759 998196

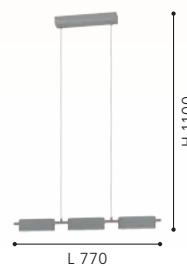

99821 ROVIRA

pendant light; aluminium, steel, black / plastic, white
Hängeleuchte; Alu, Stahl, schwarz / Kunststoff, weiss
luminaire en suspension; aluminium, acier, noir / plastique, blanc

L 770, B 50, H 1100



LED warm WHITE 3x 6,7W 2400lm



9 002759 998219

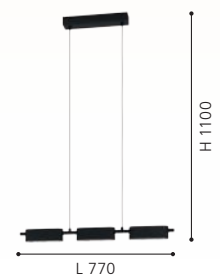



98492 AMONTILLADO

pendant light; aluminium, steel, black / plastic, white
 Hängeleuchte; Alu, Stahl, schwarz / Kunststoff, weiss
 luminaire en suspension; aluminium, acier, noir / plastique, blanc

L 1160, B 85, H 1100



2x 13,5W 3500lm



9 002759 984922

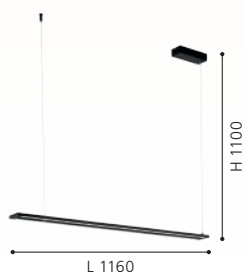

99599 CAMBULOS

pendant light; steel, black / plastic, white
 Hängeleuchte; Stahl, schwarz / Kunststoff, weiss
 luminaire en suspension; acier, noir / plastique, blanc

L 935, B 105, H 1100



2x 17W 4300lm



9 002759 995997



98495 SPADAFORA

pendant light; aluminium, steel, black / plastic, clear, white
 Hängeleuchte; Alu, Stahl, schwarz / Kunststoff, klar, weiss
 luminaire en suspension; aluminium, acier, noir / plastique, transparent, blanc

L 1160, B 80, H 1100



2x 7,5W 2000lm



9 002759 984953

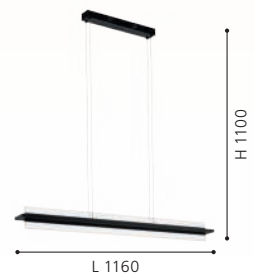

98836



98836 ERMUA

pendant light; steel, wood, black, brown / plastic, white
Hängeleuchte; Stahl, Holz, schwarz, braun / Kunststoff, weiss
luminaire en suspension; acier, bois, noir, marron / plastique, blanc

L 1000, B 165, H 1100

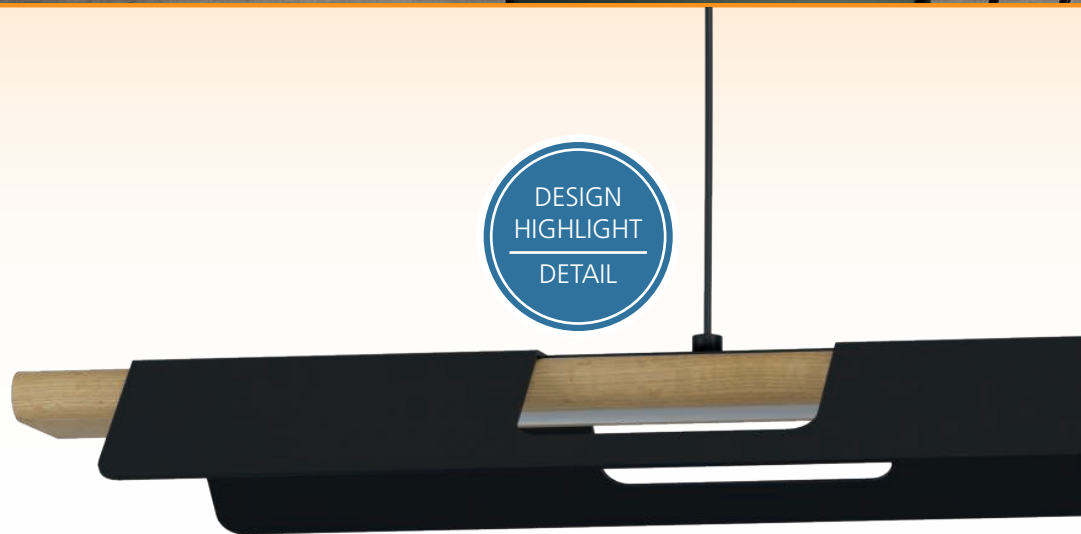

900175

LED





900174

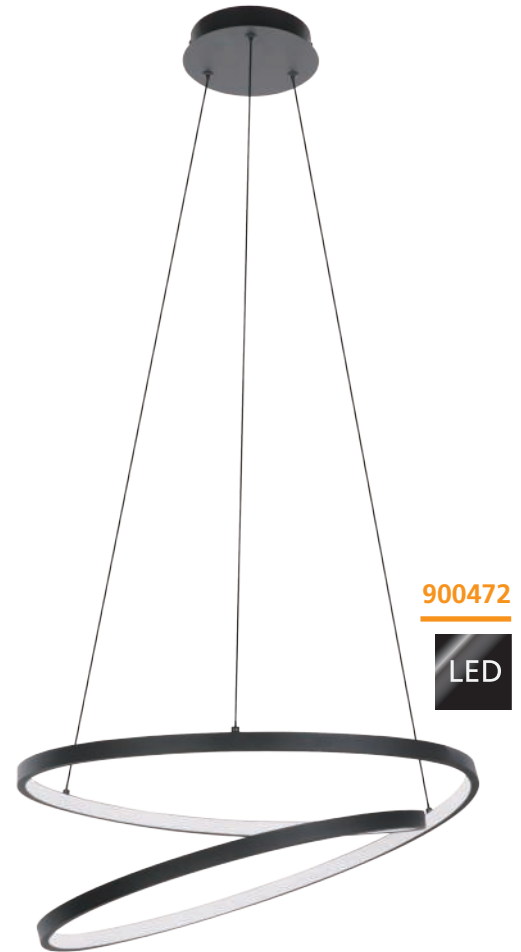

900472



900175 LISCIANA

pendant light; aluminium, steel, wood, grey / plastic, white
 Hängeleuchte; Alu, Stahl, Holz, grau / Kunststoff, weiss
 luminaire en suspension; aluminium, acier, bois, gris / plastique, blanc

L 1260, B 35, H 1100



22W 2500lm



9 008606 238088

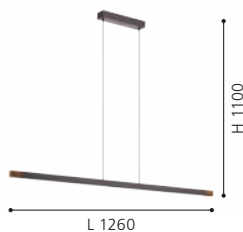

900174 LISCIANA

pendant light; aluminium, steel, wood, grey / plastic, white
 Hängeleuchte; Alu, Stahl, Holz, grau / Kunststoff, weiss
 luminaire en suspension; aluminium, acier, bois, gris / plastique, blanc

L 875, B 35, H 1100



18W 2000lm



9 008606 238071

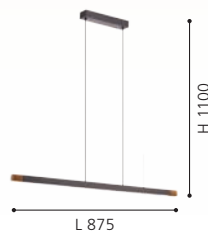

900472 RUOTALE

pendant light; aluminium, steel, black / plastic, white
 Hängeleuchte; Alu, Stahl, schwarz / Kunststoff, weiss
 luminaire en suspension; aluminium, acier, noir / plastique, blanc

H 1500, Ø 550



37W 4800lm



9 008606 239931





99818

LED

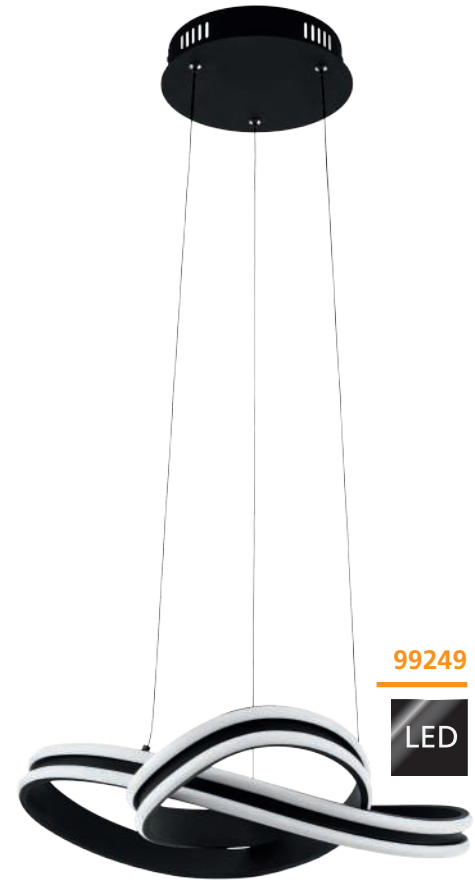

99249

LED

99818 SALITRE

pendant light; aluminium, black / plastic, white
 Hängeleuchte; Alu, schwarz / Kunststoff, weiss
 luminaire en suspension; aluminium, noir / plastique, blanc

H 1200, Ø 730



29W 4000lm

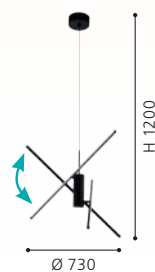

99249 CORREDERA

pendant light; steel, black / plastic, white
 Hängeleuchte; Stahl, schwarz / Kunststoff, weiss
 luminaire en suspension; acier, noir / plastique, blanc

H 1200, Ø 500



34W 5100lm

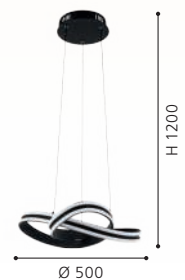

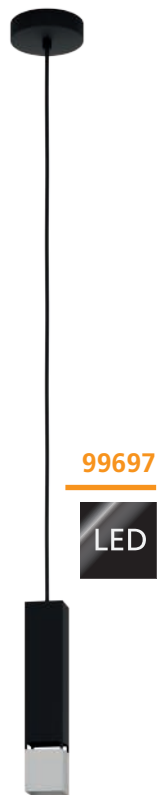

99697

LED



99698

LED

99697 BUTRANO

pendant light; steel, black, silver
 Hängeleuchte; Stahl, schwarz, silber
 luminaire en suspension; acier, noir, argent

L 55, B 55, H 1100

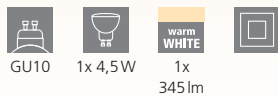

GU10 1x 4,5W 1x 345lm



99698 BUTRANO

pendant light; steel, black, silver
 Hängeleuchte; Stahl, schwarz, silber
 luminaire en suspension; acier, noir, argent

L 770, B 55, H 1100



GU10 3x 4,5W 3x 345lm





RAZONI | RAZONI 1

92252 RAZONI

pendant light; steel, black / satin glass, steel, black, white
 Hängeleuchte; Stahl, schwarz / Glas satiniert, Stahl, schwarz, weiss
 luminaire en suspension; acier, noir / verre satiné, acier, noir, blanc

H 1300, Ø 190



9 002759 922528



900828 RAZONI 1

pendant light; steel, black / steel, glass, black, white
 Hängeleuchte; Stahl, schwarz / Stahl, Glas, schwarz, weiss
 luminaire en suspension; acier, noir / acier, verre, noir, blanc

H 1100, Ø 425



9 008606 267958



94389 RAZONI

pendant light; steel, black / satin glass, steel, black, white
 Hängeleuchte; Stahl, schwarz / Glas satiniert, Stahl, schwarz, weiss
 luminaire en suspension; acier, noir / verre satiné, acier, noir, blanc

L 990, B 190, H 1100



9 002759 943899

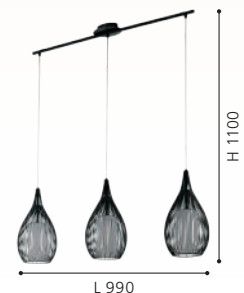



92251

900829

94388

92251 RAZONI

pendant light; steel, white / satin glass, steel, white
 Hängeleuchte; Stahl, weiss / Glas satiniert, Stahl, weiss
 luminaire en suspension; acier, blanc / verre satiné, acier, blanc

H 1300, Ø 190



900829 RAZONI 1

pendant light; steel, white / steel, glass, white
 Hängeleuchte; Stahl, weiss / Stahl, Glas, weiss
 luminaire en suspension; acier, blanc / acier, verre, blanc

H 1100, Ø 425



94388 RAZONI

pendant light; steel, white / satin glass, steel, white
 Hängeleuchte; Stahl, weiss / Glas satiniert, Stahl, weiss
 luminaire en suspension; acier, blanc / verre satiné, acier, blanc

L 990, B 190, H 1100





97066



98689

97066 ESTEVAU

pendant light; steel, dark brown
 Hängeleuchte; Stahl, dunkelbraun
 luminaire en suspension; acier, marron foncé

L 975, B 145, H 1100



98689 OKINZURI

pendant light; steel, brass
 Hängeleuchte; Stahl, messing
 luminaire en suspension; acier, laiton

H 1100, Ø 450



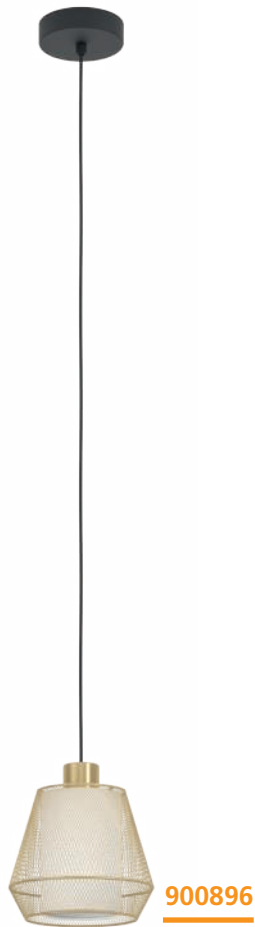

900896



900896 CIUADELA

pendant light; steel, black / steel, fabric, brushed brass, white
 Hängeleuchte; Stahl, schwarz / Stahl, Textil, messing-gebürstet, weiss
 luminaire en suspension; acier, noir / acier, tissu, laiton brossé, blanc

H 1100, Ø 180



E27 1x 40W



9 008606 274673



900897 CIUADELA

pendant light; steel, black / steel, fabric, brushed brass, white
 Hängeleuchte; Stahl, schwarz / Stahl, Textil, messing-gebürstet, weiss
 luminaire en suspension; acier, noir / acier, tissu, laiton brossé, blanc

L 880, B 180, H 1100



E27 3x 40W



9 008606 274680





DESIGN
HIGHLIGHT
DETAIL



99635 | 99636

99634

99636

99634 MASETA

pendant light; steel, black / smoked glass, black-transparent
Hängeleuchte; Stahl, schwarz / Rauchglas, schwarz-transparent
luminaire en suspension; acier, noir / verre fumé, noir transparent

L 930, B 225, H 1100



E27

3x 40W



9 002759 996345



99636 MASETA

pendant light; steel, gold-coloured / matte-opal glass, white
Hängeleuchte; Stahl, goldfarben / Glas opal-matt, weiss
luminaire en suspension; acier, or / verre opale mat, blanc

L 930, B 225, H 1100



E27

3x 40W



9 002759 996369



99635 MASETA

pendant light; steel, gold-coloured / matte-opal glass, white
Hängeleuchte; Stahl, goldfarben / Glas opal-matt, weiss
luminaire en suspension; acier, or / verre opale mat, blanc

H 1100, Ø 225



E27

1x 40W



9 002759 996352



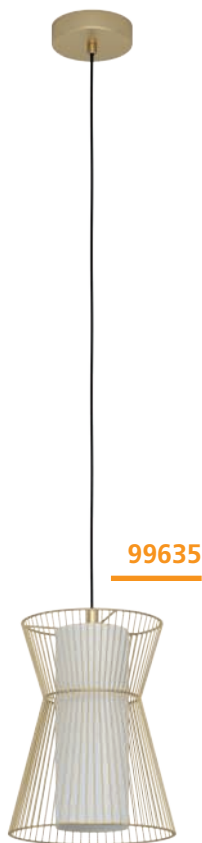

99633 | 99634

99633 MASETA

pendant light; steel, black / smoked glass, black-transparent
Hängeleuchte; Stahl, schwarz / Rauchglas, schwarz-transparent
luminaire en suspension; acier, noir / verre fumé, noir transparent

H 1100, Ø 225



E27



1x 40W

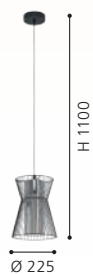



99705 FLORESTA

pendant light; steel, black / glass vaporized, black-transparent
 Hängeleuchte; Stahl, schwarz / Glas bedampft, schwarz-transparent
 luminaire en suspension; acier, noir / verre vaporisé, noir transparent

H 1100, Ø 195



99706 FLORESTA

pendant light; steel, black / glass vaporized, black-transparent
 Hängeleuchte; Stahl, schwarz / Glas bedampft, schwarz-transparent
 luminaire en suspension; acier, noir / verre vaporisé, noir transparent

L 890, B 190, H 1100



99707 ZOCABON

pendant light; steel, black / glass, clear
 Hängeleuchte; Stahl, schwarz / Glas, klar
 luminaire en suspension; acier, noir / verre, transparent

L 815, B 110, H 1100



99707





99618



99619



99618 MULEGES

pendant light; steel, black / matte-opal glass, white
Hängeleuchte; Stahl, schwarz / Glas opal-matt, weiss
luminaire en suspension; acier, noir / verre opale mat, blanc

H 1100, Ø 160



9 002759 996185

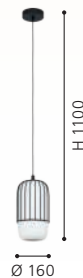

99619 MULEGES

pendant light; steel, black / matte-opal glass, white
Hängeleuchte; Stahl, schwarz / Glas opal-matt, weiss
luminaire en suspension; acier, noir / verre opale mat, blanc

L 960, B 160, H 1100



9 002759 996192





900867 TERRAROSA

pendant light; steel, sandy / fabric, white
 Hängeleuchte; Stahl, sandfarben / Textil, weiss
 luminaire en suspension; acier, couleur sable / tissu, blanc

H 1100, Ø 285



900866 TERRAROSA

pendant light; steel, sandy / fabric, white
 Hängeleuchte; Stahl, sandfarben / Textil, weiss
 luminaire en suspension; acier, couleur sable / tissu, blanc

H 1100, Ø 240





99661



99662

99661 CURASAO

pendant light; steel, black / steel, fabric, black, gold
 Hängeleuchte; Stahl, schwarz / Stahl, Textil, schwarz, gold
 luminaire en suspension; acier, noir / acier, tissu, noir, or

H 1100, Ø 335



99662 CURASAO

pendant light; steel, black / steel, fabric, black, gold
 Hängeleuchte; Stahl, schwarz / Stahl, Textil, schwarz, gold
 luminaire en suspension; acier, noir / acier, tissu, noir, or

L 995, B 235, H 1100



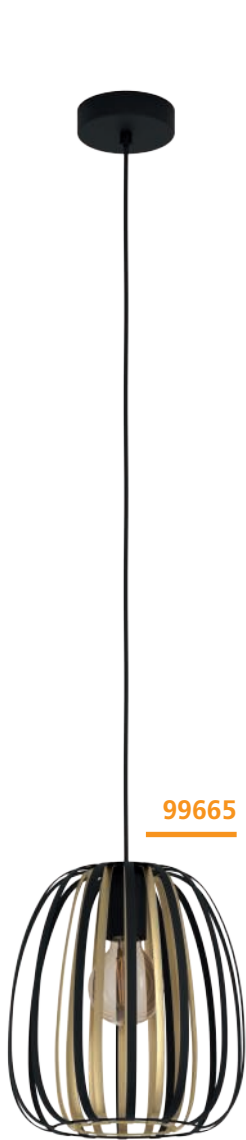

99665

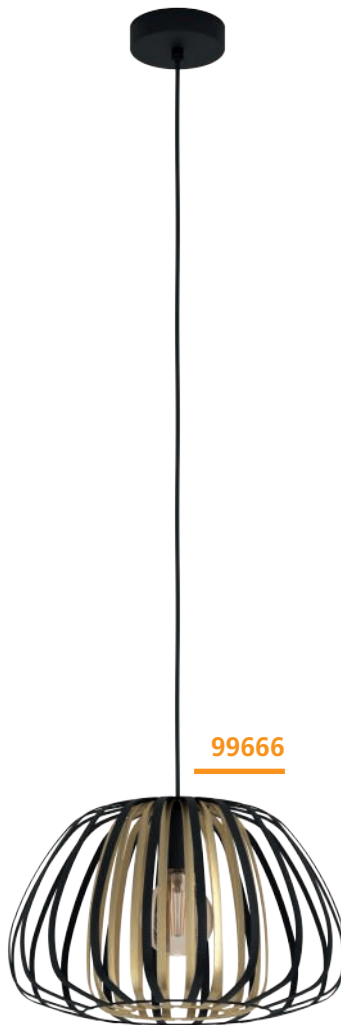

99666



DESIGN
HIGHLIGHT
DETAIL

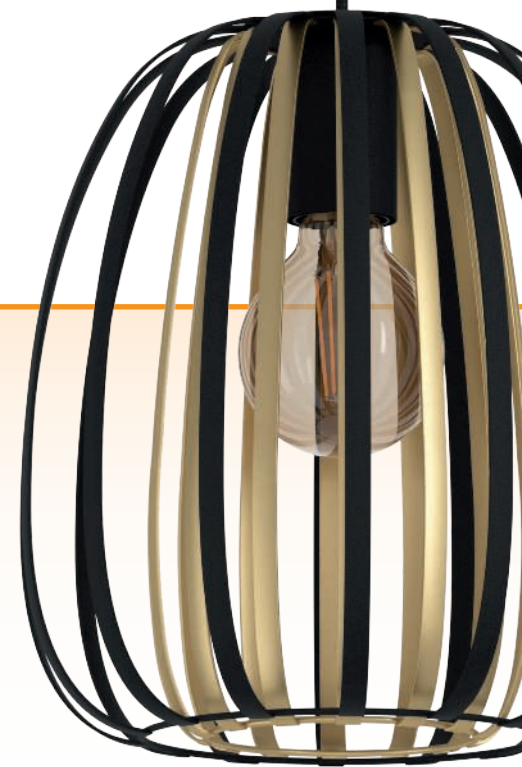

99665 ENCINITOS

pendant light; steel, black, gold
Hängeleuchte; Stahl, schwarz, gold
luminaire en suspension; acier, noir, or

H 1100, Ø 255



E27 1x 40W



9 002759 996659



Ø 255

99666 ENCINITOS

pendant light; steel, black, gold
Hängeleuchte; Stahl, schwarz, gold
luminaire en suspension; acier, noir, or

H 1100, Ø 375



E27 1x 40W



9 002759 996666



Ø 375



99694

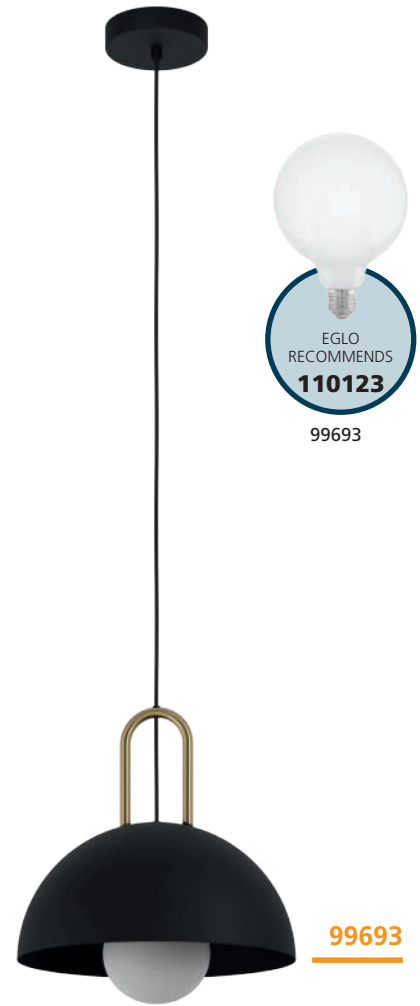

99693

99694 CALMANERA

pendant light; steel, black, brass
 Hängeleuchte; Stahl, schwarz, messing
 luminaire en suspension; acier, noir, laiton

L 900, B 200, H 1100



9 002759 996949



99693 CALMANERA

pendant light; steel, black, brass
 Hängeleuchte; Stahl, schwarz, messing
 luminaire en suspension; acier, noir, laiton

H 1100, Ø 325



9 002759 996932

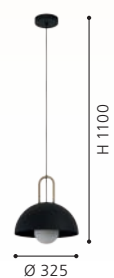



99695 | 99696

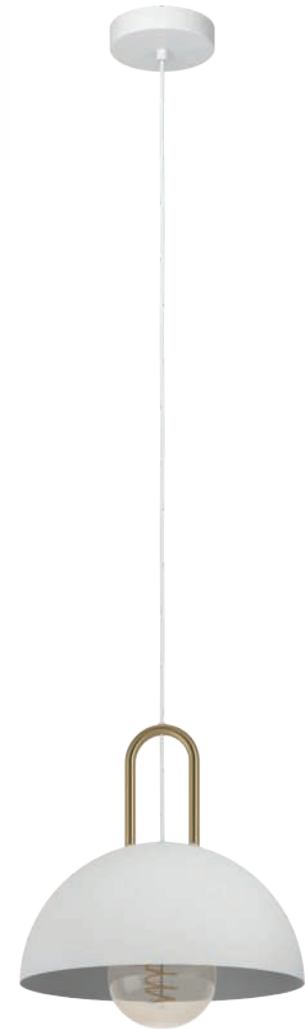

99695

99696 CALMANERA

pendant light; steel, white, brass
 Hängeleuchte; Stahl, weiss, messing
 luminaire en suspension; acier, blanc, laiton

L 900, B 200, H 1100



99695 CALMANERA

pendant light; steel, white, brass
 Hängeleuchte; Stahl, weiss, messing
 luminaire en suspension; acier, blanc, laiton

H 1100, Ø 325

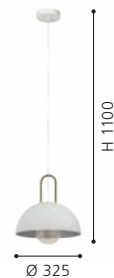



900429

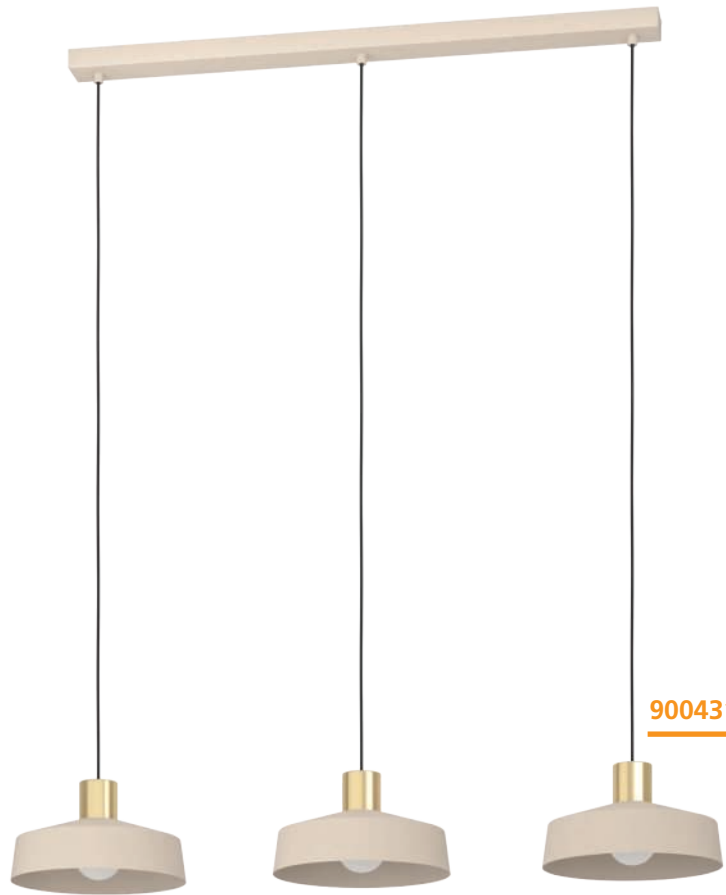

900431

900429 VALDIOLA

pendant light; steel, sandy, brushed brass
 Hängeleuchte; Stahl, sandfarben, messing-gebürstet
 luminaire en suspension; acier, couleur sable, laiton brossé

H 1100, Ø 360



E27 1x 40W



9 008606 240562

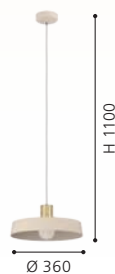

900431 VALDIOLA

pendant light; steel, sandy, brushed brass
 Hängeleuchte; Stahl, sandfarben, messing-gebürstet
 luminaire en suspension; acier, couleur sable, laiton brossé

L 930, B 230, H 1100



E27 3x 40W



9 008606 240579

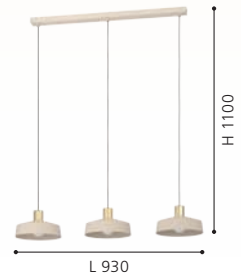



98839

LED



98838

LED

98839 LOSALOMAS

pendant light; steel, mocha-coloured, brushed brass
 Hängeleuchte; Stahl, Mokkafarben, messing-gebürstet
 luminaire en suspension; acier, café, laiton brossé

L 835, B 135, H 1100



98838 LOSALOMAS

pendant light; steel, mocha-coloured, brushed brass
 Hängeleuchte; Stahl, Mokkafarben, messing-gebürstet
 luminaire en suspension; acier, café, laiton brossé

H 1100, Ø 135

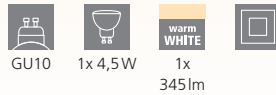



900425 BOLIVIA

pendant light; steel, black / steel, black, sandy
 Hängeleuchte; Stahl, schwarz / Stahl, schwarz, sandfarben
 luminaire en suspension; acier, noir / acier, noir, couleur sable

H 1100, Ø 180



900426 BOLIVIA

pendant light; steel, black / steel, black, sandy
 Hängeleuchte; Stahl, schwarz / Stahl, schwarz, sandfarben
 luminaire en suspension; acier, noir / acier, noir, couleur sable

L 880, B 180, H 1100



900143 CAMBAITO

pendant light; steel, sandy
 Hängeleuchte; Stahl, sandfarben
 luminaire en suspension; acier, couleur sable

L 895, B 195, H 1100

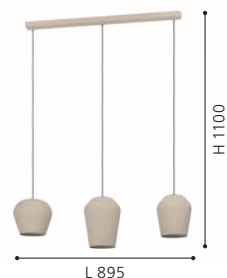

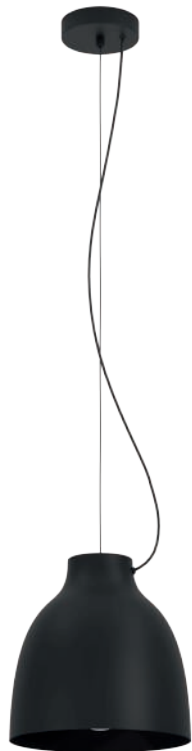

900158



900159

900158 CAMASCA

pendant light; steel, black
Hängeleuchte; Stahl, schwarz
luminaire en suspension; acier, noir

H 500 - 1100, Ø 280

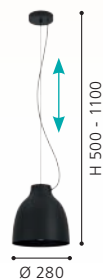

900159 CAMASCA

pendant light; steel, taupe
Hängeleuchte; Stahl, taupe
luminaire en suspension; acier, taupe

H 500 - 1100, Ø 280

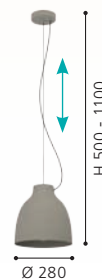

CAMASCA

These luminaires are height adjustable.
Diese Leuchten sind höhenverstellbar.
Ces luminaires sont réglables en hauteur.





900836

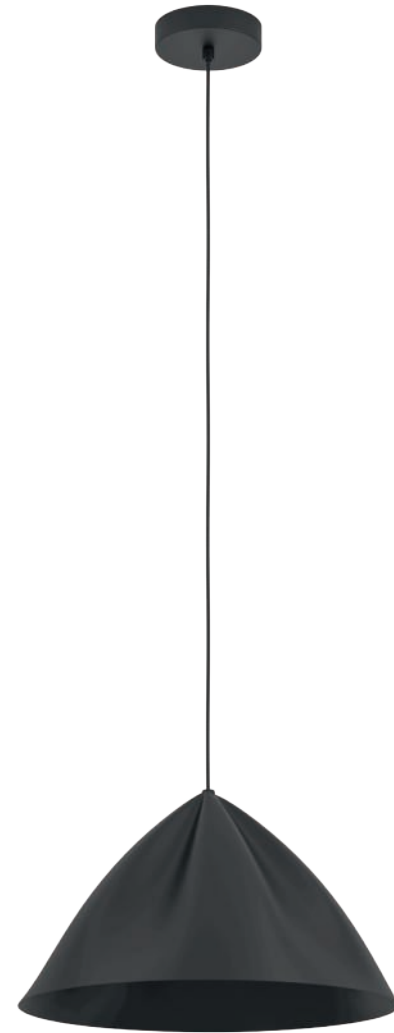

900835

900836 PODERE

pendant light; steel, sandy
 Hängeleuchte; Stahl, sandfarben
 luminaire en suspension; acier, couleur sable

H 1100, Ø 425



E27 1x 40W



900835 PODERE

pendant light; steel, black
 Hängeleuchte; Stahl, schwarz
 luminaire en suspension; acier, noir

H 1100, Ø 425



E27 1x 40W

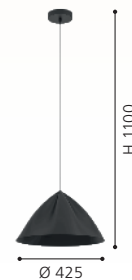



900346 GAZZOLA

pendant light; steel, mocha-coloured, sandy
 Hängeleuchte; Stahl, Mokka, Sandfarben
 luminaire en suspension; acier, café, couleur sable

L 910, B 150, H 1100

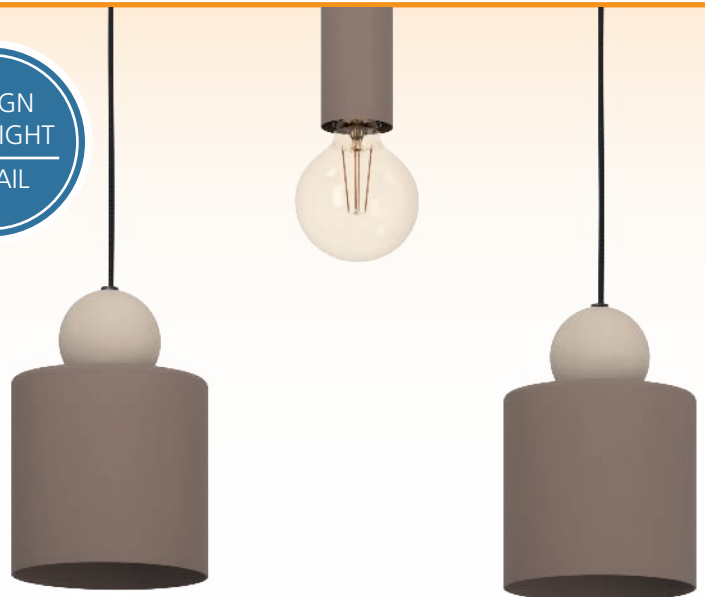
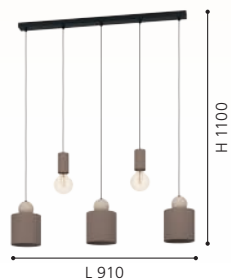



99439



99438

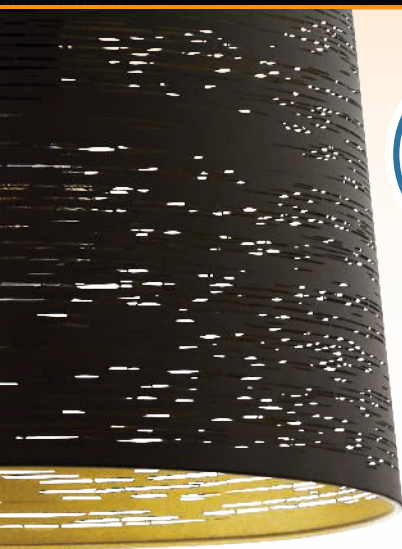

99439 SEGEZIA

pendant light; steel, mocha-coloured / steel, mocha colour, gold
 Hängeleuchte; Stahl, Mokkafarben / Stahl, Mokka, gold
 luminaire en suspension; acier, café / acier, Mokka, or

H 1100, Ø 350



9 002759 994396



99438 SEGEZIA

pendant light; steel, mocha-coloured / steel, mocha colour, gold
 Hängeleuchte; Stahl, Mokkafarben / Stahl, Mokka, gold
 luminaire en suspension; acier, café / acier, Mokka, or

L 880, B 180, H 1100



9 002759 994389





98353 RAMON

pendant light; steel, black / film, white
 Hängeleuchte; Stahl, schwarz / Folie, weiss
 luminaire en suspension; acier, noir / film, blanc

L 860, B 160, H 1100

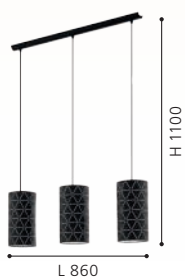

98071 CAMASTRA

pendant light; steel, black, gold
 Hängeleuchte; Stahl, schwarz, gold
 luminaire en suspension; acier, noir, or

H 1100, Ø 225

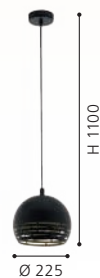

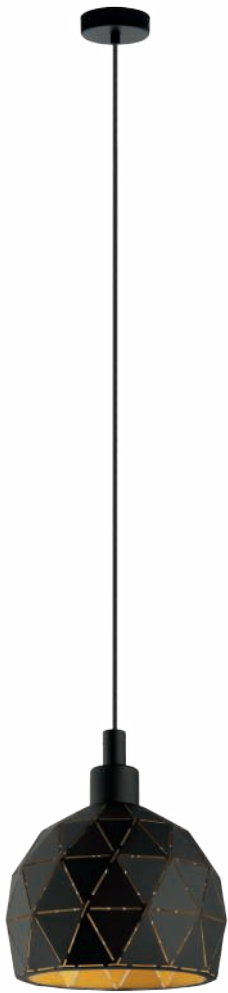

33345



97845



97841

33345 ROCCAFORTE

pendant light; steel, black, gold
Hängeleuchte; Stahl, schwarz, gold
luminaire en suspension; acier, noir, or

H 1100, Ø 170



E14 1x 40W



9 002759 333454

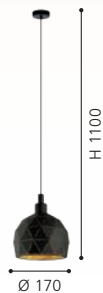

97845 ROCCAFORTE

pendant light; steel, black, gold
Hängeleuchte; Stahl, schwarz, gold
luminaire en suspension; acier, noir, or

H 1100, Ø 300



E27 1x 60W



9 002759 978457



97841 ROCCAFORTE

pendant light; steel, black, gold
Hängeleuchte; Stahl, schwarz, gold
luminaire en suspension; acier, noir, or

H 1100, Ø 400



E27 1x 60W



9 002759 978419

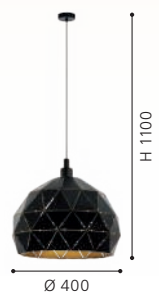



97846

97846 ROCCAFORTE

pendant light; steel, black, gold
Hängeleuchte; Stahl, schwarz, gold
luminaire en suspension; acier, noir, or

L 750, B 170, H 1100



E14



3x 40W



9 002759 978464

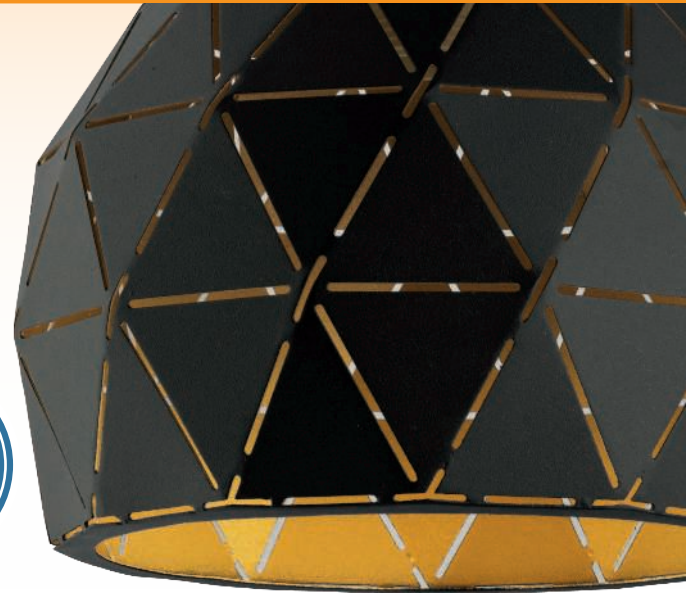
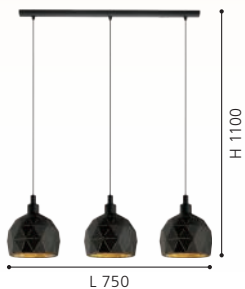



33344



97854

33344 ROCCAFORTE

pendant light; steel, white
Hängeleuchte; Stahl, weiss
luminaire en suspension; acier, blanc

H 1100, Ø 170



E14



1x 40W



9 002759 333447





97855



97857

97854 ROCCAFORTE

pendant light; steel, white
Hängeleuchte; Stahl, weiss
luminaire en suspension; acier, blanc

H 1100, Ø 300



E27 1x 60W



9 002759 978549



97855 ROCCAFORTE

pendant light; steel, white
Hängeleuchte; Stahl, weiss
luminaire en suspension; acier, blanc

H 1100, Ø 400



E27 1x 60W



9 002759 978556



97857 ROCCAFORTE

pendant light; steel, white
Hängeleuchte; Stahl, weiss
luminaire en suspension; acier, blanc

L 750, B 170, H 1100

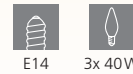

E14 3x 40W



9 002759 978570

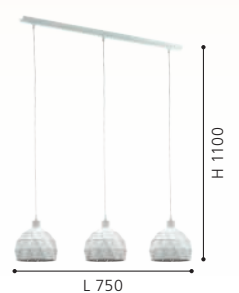



93373



93374

DESIGN
HIGHLIGHT
DETAIL

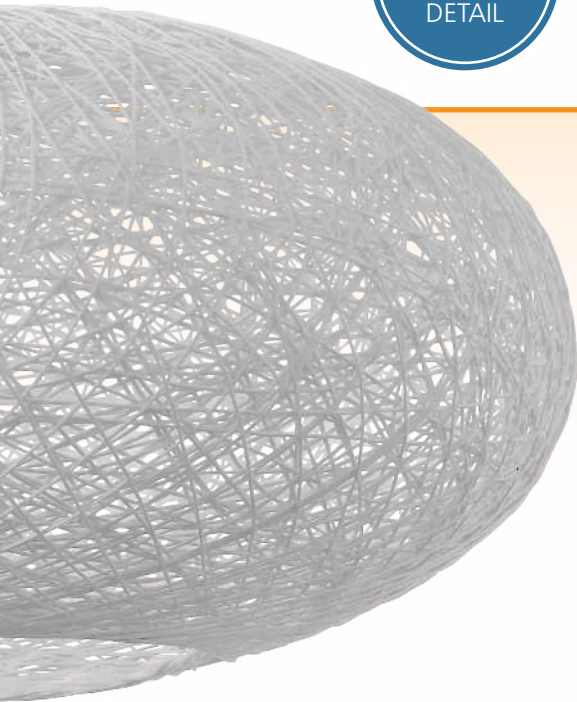

93373 CAMPILO

pendant light; plastic, white / paper threads, white
Hängeleuchte; Kunststoff, weiss / Papierfäden, weiss
luminaire en suspension; plastique, blanc / fils de papier, blanc

H 1100, Ø 450



9 002759 933739



93374 CAMPILO

pendant light; plastic, white / paper threads, beige
Hängeleuchte; Kunststoff, weiss / Papierfäden, beige
luminaire en suspension; plastique, blanc / fils de papier, beige

H 1100, Ø 450



9 002759 933746

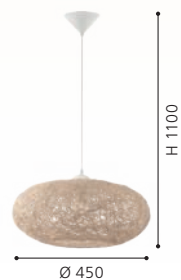



95385



95383

95385 OBREGON

pendant light; steel, brown, cream, oak
 Hängeleuchte; Stahl, braun, creme, eiche
 luminaire en suspension; acier, marron, crème, chêne

H 1100, Ø 350



9 002759 953850

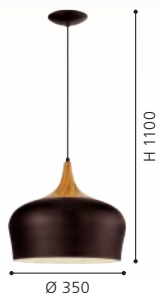

95383 OBREGON

pendant light; steel, cream, oak
 Hängeleuchte; Stahl, creme, eiche
 luminaire en suspension; acier, crème, chêne

H 1100, Ø 350



9 002759 953836





900161

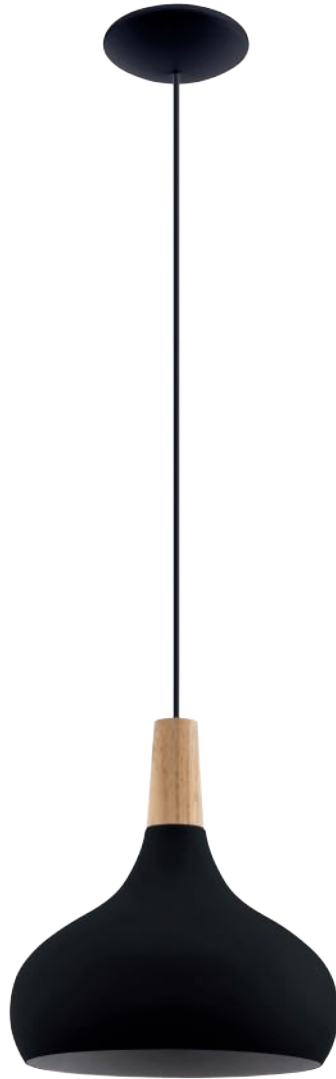

900162



900163



900161 SABINAR

pendant light; steel, wood, black, brown
Hängeleuchte; Stahl, Holz, schwarz, braun
luminaire en suspension; acier, bois, noir, marron

H 1100, Ø 180



E27 1x 40W



9 008606 235773

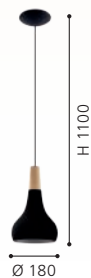

Ø 180

900162 SABINAR

pendant light; steel, wood, black, brown
Hängeleuchte; Stahl, Holz, schwarz, braun
luminaire en suspension; acier, bois, noir, marron

H 1100, Ø 280



E27 1x 40W



9 008606 235780



Ø 280

900163 SABINAR

pendant light; steel, wood, black, brown
Hängeleuchte; Stahl, Holz, schwarz, braun
luminaire en suspension; acier, bois, noir, marron

H 1100, Ø 400



E27 1x 40W



9 008606 235797

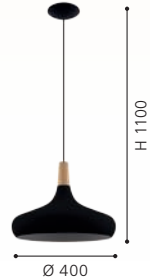

Ø 400



96981



96982



96983

96981 SABINAR

pendant light; steel, white / wood, brown
Hängeleuchte; Stahl, weiss / Holz, braun
luminaire en suspension; acier, blanc / bois, marron

H 1100, Ø 180



9 002759 969813

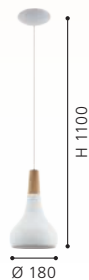

96982 SABINAR

pendant light; steel, white / wood, brown
Hängeleuchte; Stahl, weiss / Holz, braun
luminaire en suspension; acier, blanc / bois, marron

H 1100, Ø 280



9 002759 969820

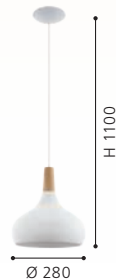

96983 SABINAR

pendant light; steel, white / wood, brown
Hängeleuchte; Stahl, weiss / Holz, braun
luminaire en suspension; acier, blanc / bois, marron

H 1100, Ø 400



9 002759 969837





96985





96986



96985 SABINAR

pendant light; steel, brushed silver / wood, brown
Hängeleuchte; Stahl, silber gebürstet / Holz, braun
luminaire en suspension; acier, argent brossé / bois, marron

H 1100, Ø 280



E27 1x 60W



9 002759 969851

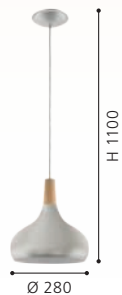

96986 SABINAR

pendant light; steel, brushed silver / wood, brown
Hängeleuchte; Stahl, silber gebürstet / Holz, braun
luminaire en suspension; acier, argent brossé / bois, marron

H 1100, Ø 400



E27 1x 60W



9 002759 969868



900186



900446

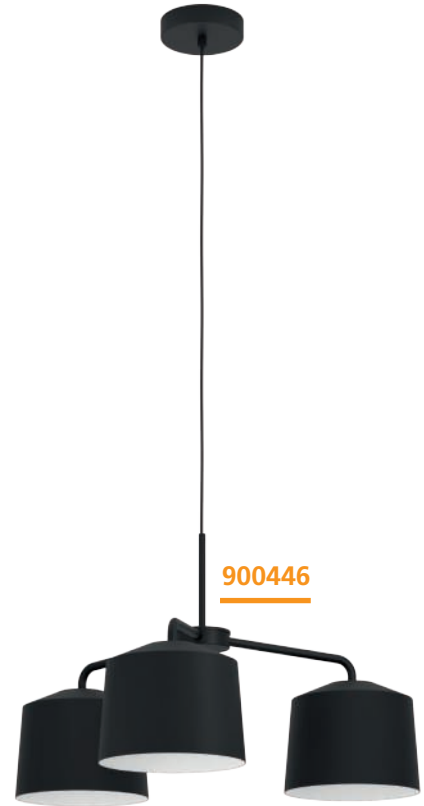

DESIGN HIGHLIGHT
DETAIL

900186 FILAGO

pendant light; steel, wood, black, brown / glass, black-grey-transparent
Hängeleuchte; Stahl, Holz, schwarz, braun / Glas, schwarz-grau-transparent
luminaire en suspension; acier, bois, noir, marron / verre, noir gris transparent
L 880, B 145, H 1100



900446 CAGUANES

pendant light; steel, black, white
Hängeleuchte; Stahl, schwarz, weiss
luminaire en suspension; acier, noir, blanc

H 1100, Ø 665

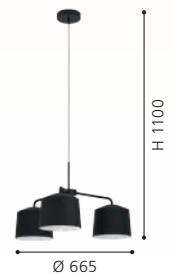



99702 VIGLIONI

pendant light; steel, wood, black, brown / glass vaporized, black-transparent

Hängeleuchte; Stahl, Holz, schwarz, braun / Glas bedampft, schwarz-transparent

luminaire en suspension; acier, bois, noir, marron / verre vaporisé, noir transparent

L 1060, B 165, H 1100



E27 3x 40W



9 002759 997021

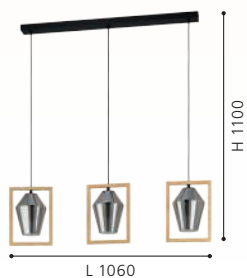

99701 VIGLIONI

pendant light; steel, wood, black, brown / glass vaporized, black-transparent

Hängeleuchte; Stahl, Holz, schwarz, braun / Glas bedampft, schwarz-transparent

luminaire en suspension; acier, bois, noir, marron / verre vaporisé, noir transparent

L 230, B 165, H 1100



E27 1x 40W



9 002759 997014



900444 TARRAFO

pendant light; steel, wood, black, brown

Hängeleuchte; Stahl, Holz, schwarz, braun

luminaire en suspension; acier, bois, noir, marron

L 880, B 150, H 1100



E27 4x 40W



9 008606 243952

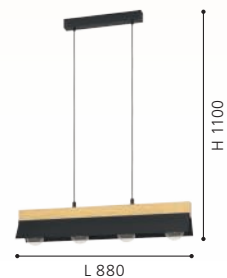

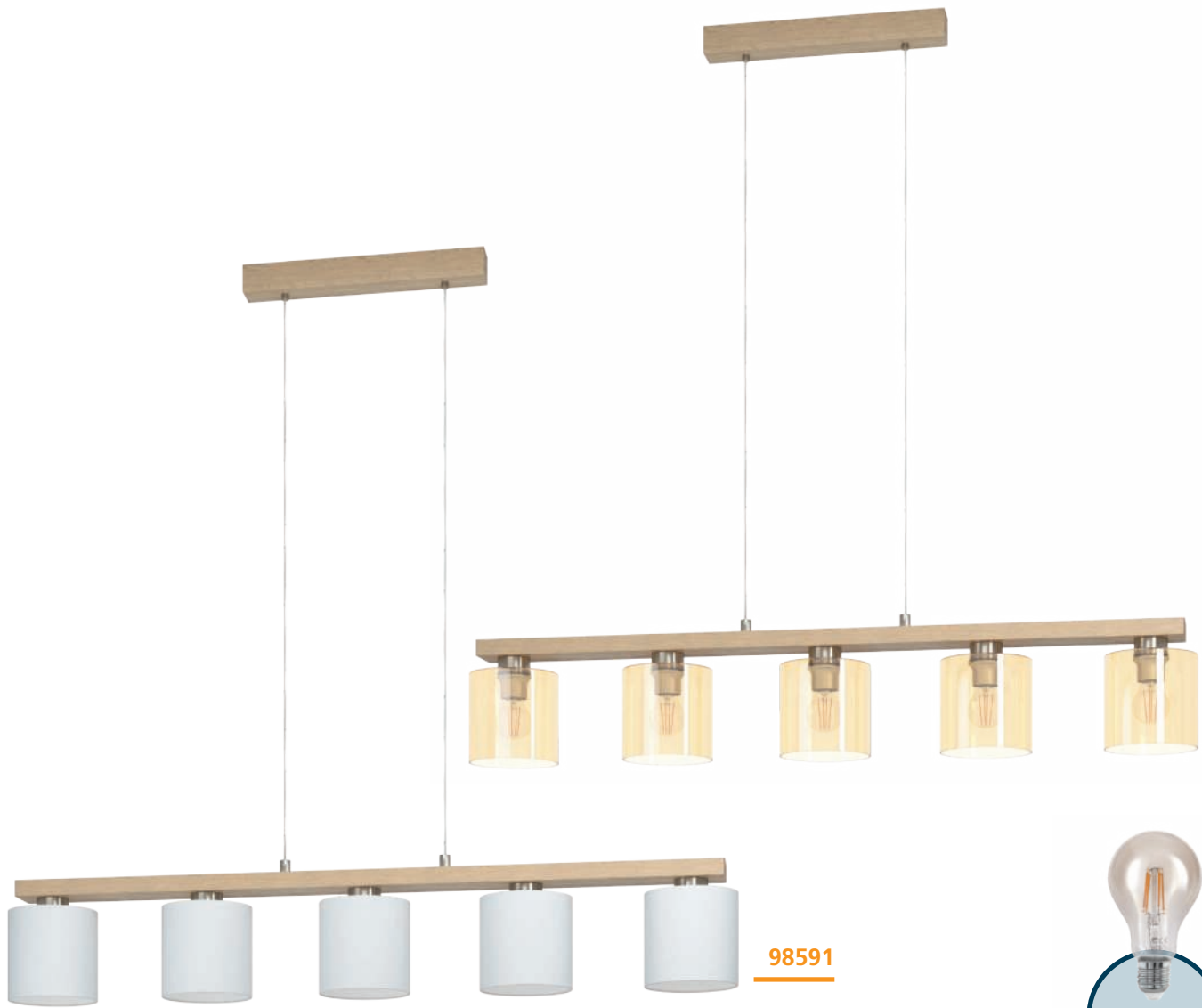

98592

98591



98592

98591 CASTRALVO

pendant light; steel, wood, satin nickel, brown / fabric, white
 Hängeleuchte; Stahl, Holz, nickel-matt, braun / Textil, weiss
 luminaire en suspension; acier, bois, nickel mat, marron / tissu, blanc

L 1210, B 150, H 1100



E27 5x 28W



9 002759 985912

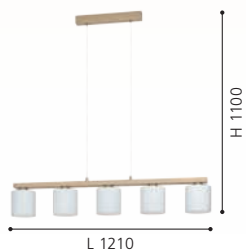

98592 CASTRALVO

pendant light; steel, wood, satin nickel, brown / glass vaporized, amber
 Hängeleuchte; Stahl, Holz, nickel-matt, braun / Glas bedampft, amber

luminaire en suspension; acier, bois, nickel mat, marron / verre vaporisé, ambre

L 1210, B 150, H 1100



E27 5x 28W



9 002759 985929

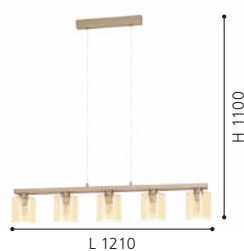

900313 CASTRALVO

pendant light; wood, steel, brown / fabric, black
 Hängeleuchte; Holz, Stahl, braun / Textil, schwarz
 luminaire en suspension; bois, acier, marron / tissu, noir

L 975, B 175, H 1100



E27 3x 40W



9 008606 235872

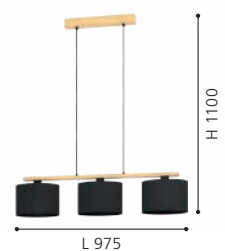

900313



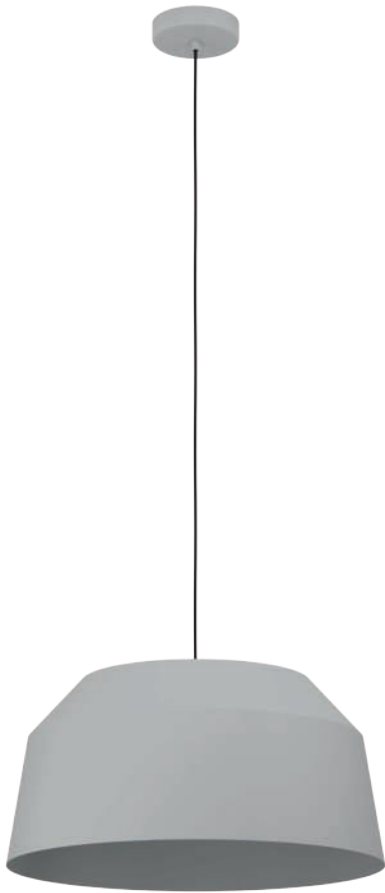

900381



900379

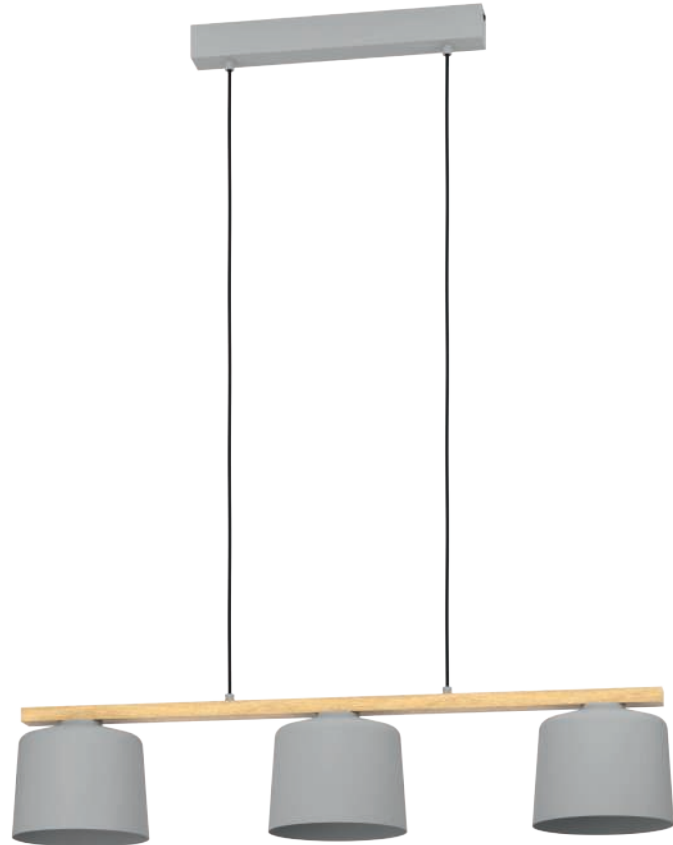

900362



CONTRISA

These luminaires are open at the top and have a beautiful play of light.

Diese Leuchten sind nach oben offen und haben ein schönes Lichtspiel.

Ces luminaires sont ouverts vers le haut et ont un beau jeu de lumière.

900381 CONTRISA

pendant light; steel, grey
Hängeleuchte; Stahl, grau
luminaire en suspension; acier, gris

H 1100, Ø 520



E27 1x 40W



9 008606 243624



900379 CONTRISA

pendant light; steel, grey
Hängeleuchte; Stahl, grau
luminaire en suspension; acier, gris

H 1100, Ø 380



E27 1x 40W



9 008606 243617

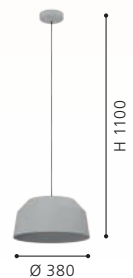

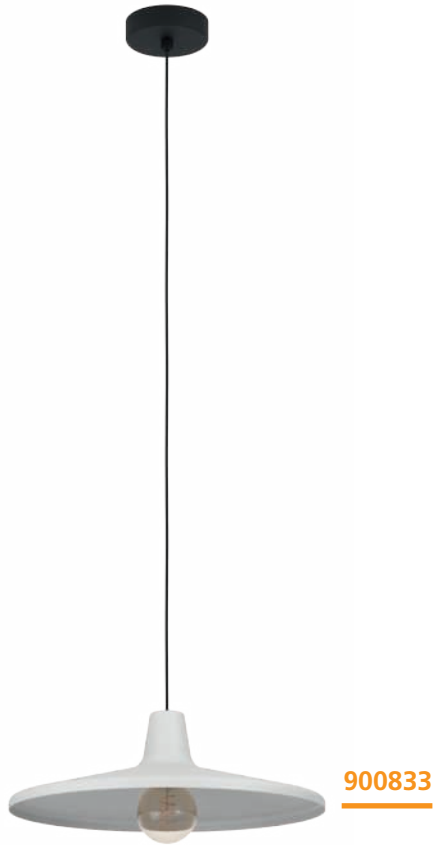

900362 MARIEL

pendant light; steel, wood, light grey, brown
 Hängeleuchte; Stahl, Holz, hellgrau, braun
 luminaire en suspension; acier, bois, gris clair, marron

L 910, B 190, H 1100

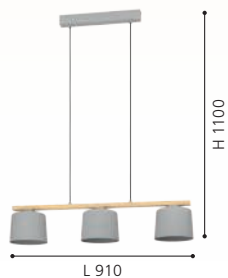

900833 MINIERE

pendant light; steel, black / steel, grey
 Hängeleuchte; Stahl, schwarz / Stahl, grau
 luminaire en suspension; acier, noir / acier, gris

H 1100, Ø 420

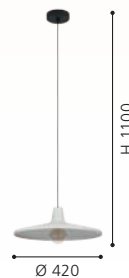

900834 MINIERE

pendant light; steel, black / steel, grey
 Hängeleuchte; Stahl, schwarz / Stahl, grau
 luminaire en suspension; acier, noir / acier, gris

L 995, B 420, H 1100





900696



900697

900696 GAETANO 1

pendant light; steel, black / steel, sandy, cream
 Hängeleuchte; Stahl, schwarz / Stahl, sandfarben, creme
 luminaire en suspension; acier, noir / acier, couleur sable, crème

H 1500, Ø 535



E27 1x 40W



900697 GAETANO 1

pendant light; steel, black / steel, grey, white
 Hängeleuchte; Stahl, schwarz / Stahl, grau, weiss
 luminaire en suspension; acier, noir / acier, gris, blanc

H 1500, Ø 535



E27 1x 40W





94936

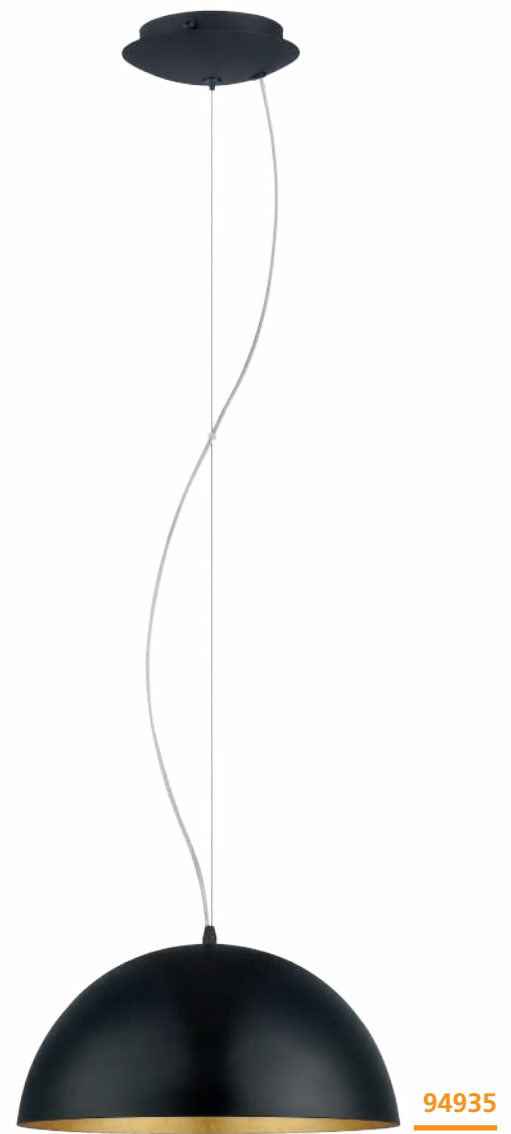

94935

94936 GAETANO 1

pendant light; steel, black, gold
 Hängeleuchte; Stahl, schwarz, gold
 luminaire en suspension; acier, noir, or

H 1500, Ø 530



9 002759 949365



Ø 530

94935 GAETANO 1

pendant light; steel, black, gold
 Hängeleuchte; Stahl, schwarz, gold
 luminaire en suspension; acier, noir, or

H 1500, Ø 380



9 002759 949358



Ø 380



900849



95755



99663

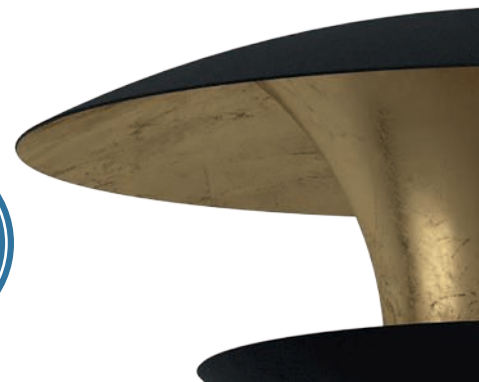

900849 CENCIARA

pendant light; steel, black / steel, brushed brass, gold
 Hängeleuchte; Stahl, schwarz / Stahl, messing-gebürstet, gold
 luminaire en suspension; acier, noir / acier, laiton brossé, or

H 1100, Ø 400



95755 NUVANO

pendant light; steel, brown, gold
 Hängeleuchte; Stahl, braun, gold
 luminaire en suspension; acier, marron, or

H 1100, Ø 480



99663 NUVANO

pendant light; steel, black, gold
 Hängeleuchte; Stahl, schwarz, gold
 luminaire en suspension; acier, noir, or

L 985, B 225, H 1100





94938

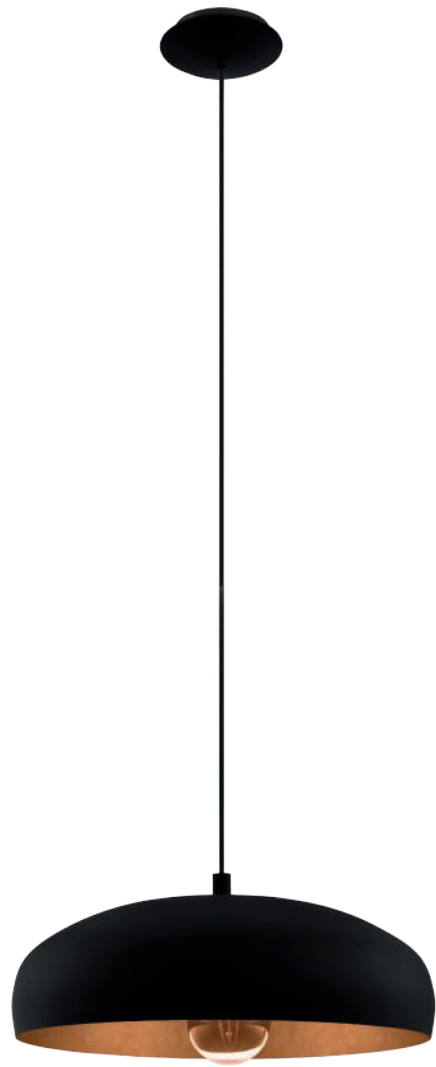

94605

94938 GAETANO 1

pendant light; steel, black, copper
 Hängeleuchte; Stahl, schwarz, kupfer
 luminaire en suspension; acier, noir, cuivre

H 1500, Ø 530



E27



1x 60W



9 002759 949389

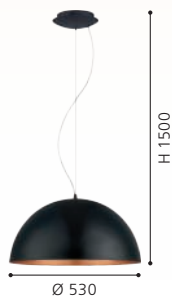

94605 MOGANO 1

pendant light; steel, black, copper
 Hängeleuchte; Stahl, schwarz, kupfer
 luminaire en suspension; acier, noir, cuivre

H 1100, Ø 400



E27



1x 60W



9 002759 946050

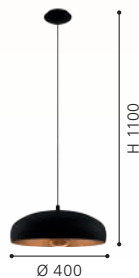

94606 MOGANO 1

pendant light; steel, white, copper
 Hängeleuchte; Stahl, weiss, kupfer
 luminaire en suspension; acier, blanc, cuivre

H 1100, Ø 400



E27



1x 60W



9 002759 946067

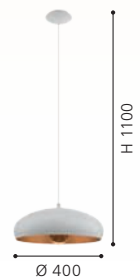



94606



98735

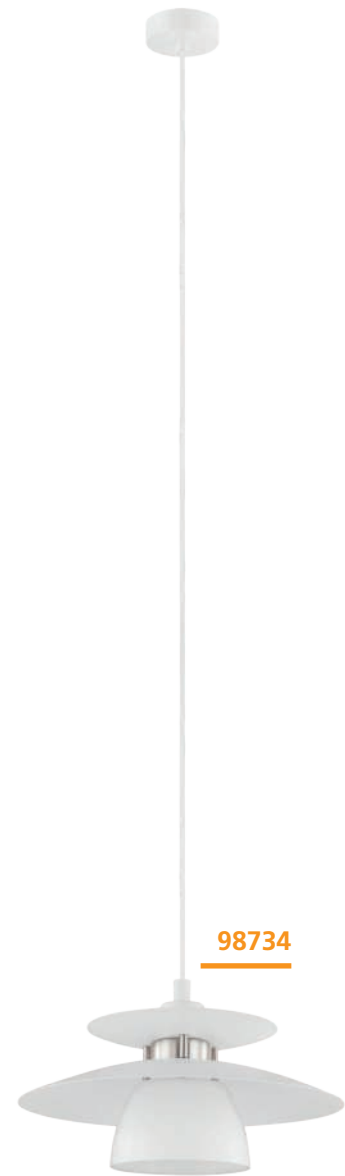

98734

98735 BRENDA

pendant light; steel, black, satin nickel
 Hängeleuchte; Stahl, schwarz, nickel-matt
 luminaire en suspension; acier, noir, nickel mat

H 1500, Ø 320



98734 BRENDA

pendant light; steel, white, satin nickel
 Hängeleuchte; Stahl, weiss, nickel-matt
 luminaire en suspension; acier, blanc, nickel mat

H 1500, Ø 320





87055



31666

87055 BRENDA

pendant light; plastic, steel, white, chrome / steel, white
 Hängeleuchte; Kunststoff, Stahl, weiss, chrom / Stahl, weiss
 luminaire en suspension; plastique, acier, blanc, chrome / acier, blanc

H 1300, Ø 430



E27 1x 60W



9 002759 870553

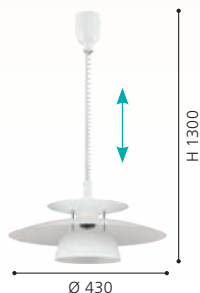

31666 BRENDA

pendant light; plastic, steel, black / steel, black, copper
 Hängeleuchte; Kunststoff, Stahl, schwarz / Stahl, schwarz, kupfer
 luminaire en suspension; plastique, acier, noir / acier, noir, cuivre

H 1100, Ø 430



E27 1x 60W



9 002759 316662

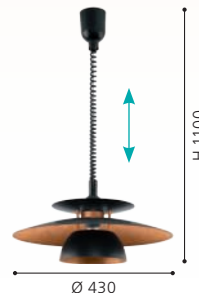

31666, 87055

This luminaires are flexible in height thanks to the spiral cables.

Diese Leuchten sind durch die Spiralkabel in der Höhe verstellbar.

La hauteur de ces lumières peut être ajustée à l'aide du câble en spirale.





87054

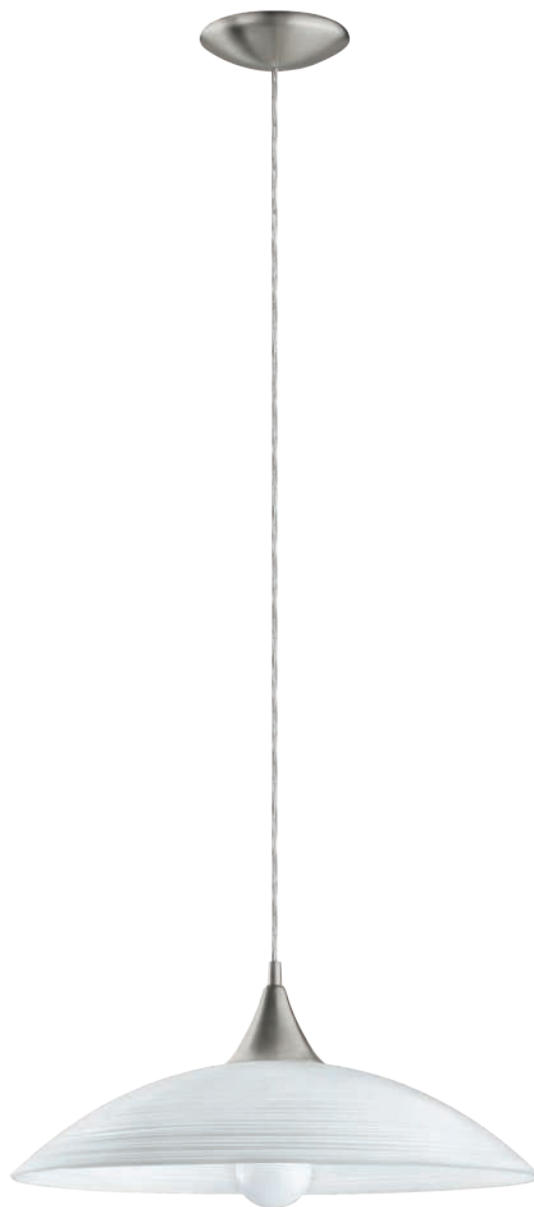

91496

87054 BRENDA

pendant light; steel, satin nickel / alabaster glass, white
 Hängeleuchte; Stahl, nickel-matt / Glas alabaster, weiss
 luminaire en suspension; acier, nickel mat / verre albâtre, blanc

H 1100, Ø 195



9 002759 870546



91496 LAZOLO

pendant light; steel, satin nickel / satin glass, white painted
 Hängeleuchte; Stahl, nickel-matt / Glas satiniert, weiss lackiert
 luminaire en suspension; acier, nickel mat / verre satiné, blanc laqué

H 1100, Ø 420



9 002759 914967

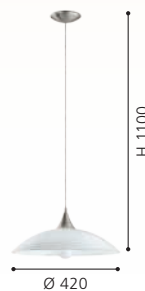

93468 MONTEFIO

pendant light; stainless steel, satin nickel / alabaster glass, white
 Hängeleuchte; Edelstahl, nickel-matt / Glas alabaster, weiss
 luminaire en suspension; acier inoxydable, nickel mat / verre albâtre, blanc

L 885, B 175, H 880 - 1300



9 002759 934682





93468

LED



87008



87009

87008 LORD 2

pendant light; plastic, steel, grey, satin nickel / alabaster glass, white

Hängeleuchte; Kunststoff, Stahl, grau, nickel-matt / Glas alabaster, weiss

luminaire en suspension; plastique, acier, gris, nickel mat / verre albâtre, blanc

H 1100, Ø 360

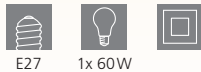

E27 1x 60W

87009 LORD 2

pendant light; plastic, wood, silver, satin nickel, beech / alabaster glass, white

Hängeleuchte; Kunststoff, Holz, silber, nickel-matt, Buche / Glas alabaster, weiss

luminaire en suspension; plastique, bois, argent, nickel mat, hêtre / verre albâtre, blanc

H 1100, Ø 360



E27 1x 60W

3355, 87008, 87009



This luminaire is flexible in height thanks to the spiral cables.

Diese Leuchten sind durch die Spiralkabel in der Höhe verstellbar.

La hauteur de ces lumières peut être ajustée à l'aide du câble en spirale.



9 002759 870089

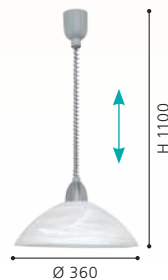

9 002759 870096

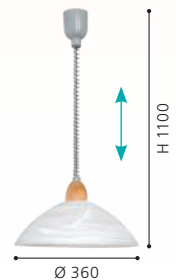



3355



90978



3355 ALESSANDRA

pendant light; plastic, white / alabaster glass, white
 Hängeleuchte; Kunststoff, weiss / Glas alabaster, weiss
 luminaire en suspension; plastique, blanc / verre albâtre, blanc

H 1100, Ø 380



E27 1x 60W

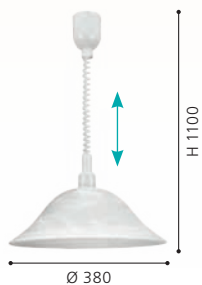

90978 ALBANY

pendant light; plastic, white / alabaster glass, white
 Hängeleuchte; Kunststoff, weiss / Glas alabaster, weiss
 luminaire en suspension; plastique, blanc / verre albâtre, blanc

H 1100, Ø 350



E27 1x 60W

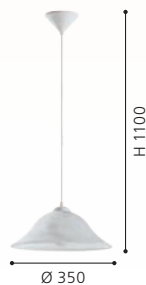

3355, 87008, 87009, 90978

These luminaires come with high quality processed alabaster glass.

Diese Leuchten sind mit hochwertigem Alabasterglas ausgestattet.

Ces luminaires viennent avec un abat-jour en verre d'albâtre haut de gamme.



3041

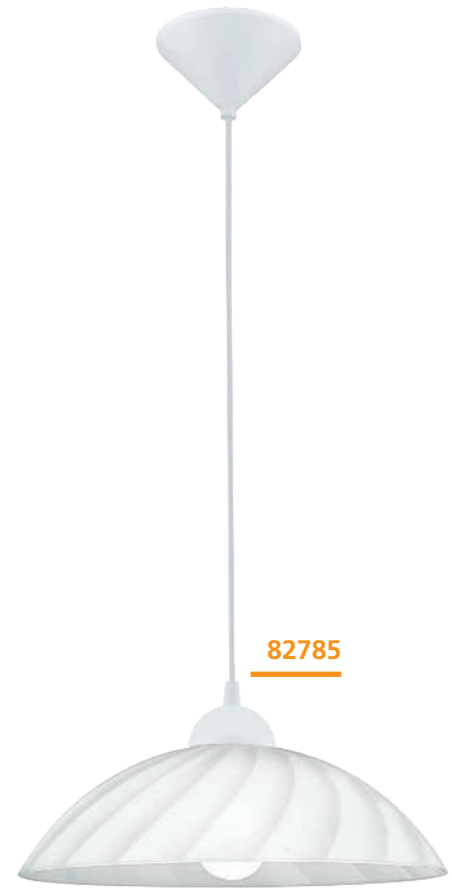

82785

3041 VETRO

pendant light; plastic, white / satin glass, white, purple, black
 Hängeleuchte; Kunststoff, weiss / Glas satiniert, weiss, lila, schwarz
 luminaire en suspension; plastique, blanc / verre satiné, blanc, violet, noir

H 1100, Ø 420



E27



1x 60W



9 002759 304102





96474

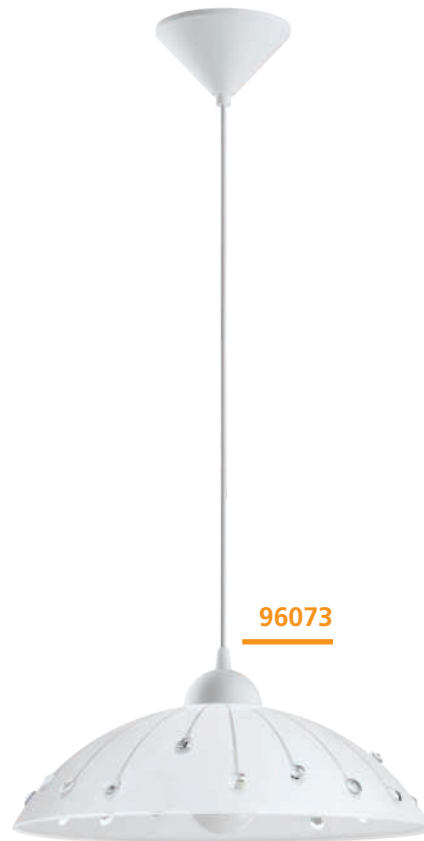

96073

3041, 96474

This luminaires are flexible in height thanks to the spiral cables.

Diese Leuchten sind durch die Spiralkabel in der Höhe verstellbar.

La hauteur de ces lumières peut être ajustée à l'aide du câble en spirale.



82785 VETRO

pendant light; plastic, white / satin glass, white
Hängeleuchte; Kunststoff, weiss / Glas satiniert, weiss
luminaire en suspension; plastique, blanc / verre satiné, blanc

H 1100, Ø 350



E27 1x 60W



9 002759 827854

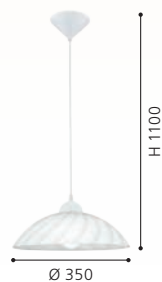

96474 ALVEZ

pendant light; plastic, white / structured glass, white, clear
Hängeleuchte; Kunststoff, weiss / Glas mit Struktur, weiss, klar
luminaire en suspension; plastique, blanc / verre avec structure, blanc, transparent

H 1100, Ø 420



E27 1x 60W



9 002759 964740



96073 VETRO

pendant light; plastic, white / satin glass, brilliant glass, white, clear
Hängeleuchte; Kunststoff, weiss / Glas satiniert, Brillantglas, weiss, klar

luminaire en suspension; plastique, blanc / verre satiné, verre brillant, blanc, transparent

H 1100, Ø 350



E27 1x 60W



9 002759 960735

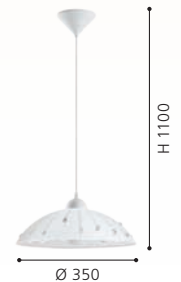



WALL & CEILING LUMINAIRES

WAND- & DECKENLEUCHTEN
APPLIQUES & PLAFONNIERS



EN OUR ALL-ROUNDERS

The range of wall and ceiling luminaires goes from simple to unusual designs. No matter if for the entrance area, hallway or your living rooms – these luminaires give the right light.

DE UNSERE ALLROUNDER

Das Sortiment an Wand- und Deckenleuchten reicht von schlichten bis hin zu ausgefallenen Designs. Egal ob für Eingangsbereich, Flur oder Ihre Wohnräume - diese Leuchten spenden das passende Licht.

FR NOS PASSE-PARTOUT



















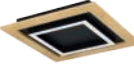



























La gamme d'éclairages muraux et de plafonds s'étend de designs simples à extraordinaires. Que ce soit pour l'entrée, le couloir ou vos espaces d'habitat - ces luminaires apportent la lumière appropriée.





OVERVIEW

WALL & CEILING LUMINAIRES
WAND- & DECKENLEUCHTEN
APPLIQUES & PLAFONNIERS

 AMANDOLO 480-481	 RUOTALE 482	 ULISANO 482	 PADULARI 482	 ROLIMARE 483	 ALTAFLOR 484-486	 MONIROTE 485, 487	 GAFARES 488-489
 ZAMPOTE 490	 IPOLITTO 490	 TIRRENARA 492	 MARINELLO 1 492	 MARINELLO 493	 MIRLAS 494	 TAMURIA 496	 BORDONARA 498
 MARMORATA 499	 BOCADELLA 1 500	 TREMEDAL 501	 MESSINARO 502	 BELSIANA 502-503	 BELSIANA 1 503	 ENCINITOS 505	 MOGANO 3 505
 MONTEBALDO 506	 BARRANCAS 506	 MORDAZO 507	 STAITI 507	 SILENTINA 508-509	 MACCHIONE 509	 PIEDRITAS 510	 MOGANO 512-513
 MOGANO 2 514	 CENCIARA 515	 MOHARRAS 515	 DUAIA 516	 VALCASOTTO 1 517	 TARRAFO 517	 BASURTU 518	 LORETO 518-519
 LORETO 1 519	 FORCADET 519	 MARIEL 520	 MAROJALES 520	 FILAGO 521	 CONDRAIDA 1 522	 CABO 522	 ACOLLA 523
 CLEMENTE 523	 FRADELO 1 524-525	 FRADELO 526-527	 VALLEMARE 529	 SORRENTA 1 529	 CANICOSA 2 530	 MONTENOVO 531	 POZONDON 531



This product is available in different colors and shapes. / Dieser Artikel ist in unterschiedlichen Farben und Formen verfügbar. / Cet article est disponible en différentes couleurs et formes.

 GIRON 532	 GIRON-S 533	 FRANIA 534-535, 538-539	 FRANIA-S 536-537, 540-541	 SILERAS 541	 LANCIANO 1 542-543	 LANCIANO 542	 FERENTINO 544-545
 BATTISTONA 546	 BENARIBA 547	 COMPETA 1 548-549	 PALERMO 2 549	 CAPASSO 550	 RENDE 551	 NIEVES 1 552	 NIEVES 553
 PESCAITO 554	 MUSURITA 554-555	 LAURITO 556	 SELUCI 556-557	 VALCASOTTO 559	 LUPPINERIA 560-562	 PENJAMO 1 562	 PENJAMO 563
 CALAGRANO 564-565	 PALAGIANO 565	 PALAGIANO 1 566	 MENTALURGIA 567	 ELLA 568	 DURELO 569	 PLANET 570	 PLANET 1 570-573
 MARGITTA 1 575	 MARS 1 576-577	 MARS 577-578	 SALOME 578-579	 MAGITTA 1 580	 SCALEA 1 580	 GRAFIK 580	 NEMO 580
 MESTRE 582-583	 IMPERIAL 582	 ALMERA 583	 PASCAL 1 583	 CAMPANIA 584	 GERBERA 1 584	 COLTI 584	 SAN PERI 586
 STAITI 1 586	 TAZZOLI 589	 CIGLIE 589	 CARTIGNANO 590	 CIVITATE 591	 TIMPAROSSA 592	 ALAMILO 593	 GURARE 593



OVERVIEW

WALL & CEILING LUMINAIRES
WAND- & DECKENLEUCHTEN
APPLIQUES & PLAFONNIERS



ZINACUA
593



ZUBIALDE
594



TUDONS
595



ONO 2
595



MACCACARI
596



FELONICHE
597



SANIA 4
598-599



PASSA
600-603



GASCUERIA
604



ELIZONDO
604



FALICETTO
604



HAYES
605



TANURA
606



GUANAL
606



CADEGAL
608-609



REMIDOS
609



METRASS
610



METRASS 2
611



METRASS 1
613



SARGINTO
614-615



This product is available in different colors and shapes. / Dieser Artikel ist in unterschiedlichen Farben und Formen verfügbar. / Cet article est disponible en différentes couleurs et formes.

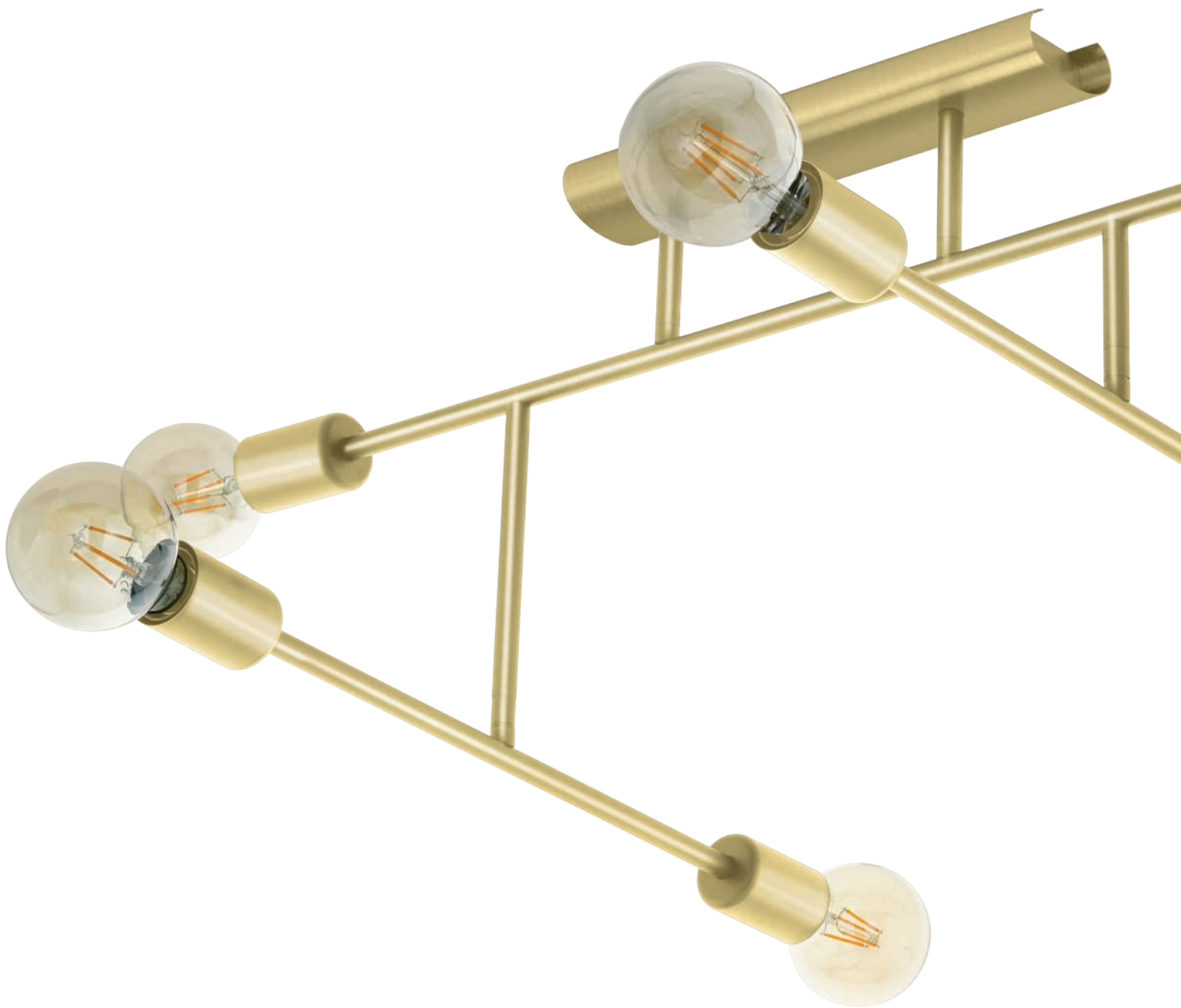

FUNCTIONAL OVERVIEW

FUNKTIONSÜBERSICHT

PRÉSENTATION FONCTIONNELLE

The listed boxes inform you about the respective functions of our wall and ceiling luminaires. You will find them on the catalogue pages next to the product illustrations. The coloured symbol area indicates the special characteristics of the respective luminaire/luminaire family, e.g. dimming function. In the grey area below you will find detailed information on this function, e.g. dimmable from 10% - 100%.

For luminaires that come with a remote control, you can control the respective functions with the remote control. For luminaires without remote control, the functions can be switched directly on the wall switch.

Die angeführten Boxen informieren Sie über die jeweiligen Funktionen unserer Wand- und Deckenleuchten. Sie finden sie auf den Katalogseiten jeweils neben den Produktabbildungen. Der farbige Symbolbereich weist darauf hin, welche besonderen Eigenschaften die jeweilige Leuchte/Leuchtenfamilie bietet, z.B. Dimmfunktion. Im grauen Bereich darunter finden Sie detaillierte Angaben zu dieser Funktion, z.B. dimmbar von 10% - 100%.

Ist eine Fernbedienung im Lieferumfang enthalten, können Sie die jeweiligen Funktionen mit der Fernbedienung steuern. Bei Leuchten ohne Fernbedienung können die Funktionen direkt am Wandschalter geschaltet werden.

Les boîtes de dialogue présentes vous informent sur les fonctions respectives de nos appliques et plafonniers. Vous les trouverez sur les pages du catalogue à côté des illustrations des produits. La zone colorée des symboles indique les caractéristiques particulières de chaque luminaire/famille de luminaires, par ex. la fonction de gradation. Dans la zone grise ci-dessous, vous trouverez des informations détaillées sur cette fonction, par ex. graduable de 10% - 100%.

Pour les luminaires équipés d'une télécommande, vous pouvez commander les fonctions correspondantes à l'aide de la télécommande. Pour les luminaires sans télécommande, les fonctions peuvent être commutées directement sur l'interrupteur mural.



DIMMABLE

e.g./z.B./par ex.
10 - 100%

The brightness of the luminaire can be steplessly controlled.

Die Helligkeit der Leuchte kann stufenlos im angegebenen Bereich gesteuert werden.

La luminosité du luminaire peut être réglée en continu.



STEP DIMMING

e.g./z.B./par ex.
10%/50%/100%

The brightness of the luminaire can be controlled step by step.

Die Helligkeit der Leuchte kann schrittweise gesteuert werden.

La luminosité du luminaire peut être réglée pas à pas.



TUNABLE WHITE

e.g./z.B./par ex.
2700 - 6500 K

The colour temperature can be controlled from warm to cold white LED light.

Die Farbtemperatur kann von warm- bis kaltweißem LED-Licht gesteuert werden.

La température de couleur peut être réglée de la lumière DEL blanche chaude à la lumière DEL blanche froide.



STEP TUNABLE

e.g./z.B./par ex.
3000/4000/5000 K

The colour temperature of warm to cold white LED light can be changed directly on the wall switch in 3 preset steps.

Die Farbtemperatur von warm- bis kaltweißem LED-Licht kann direkt am Wandschalter in 3 voreingestellten Schritten verändert werden.

La température de couleur peut être modifiée de la lumière DEL blanche chaude à la lumière DEL blanche froide directement sur l'interrupteur mural en 3 étapes prédéfinies.



NIGHT LIGHT FUNCTION

Luminaires can be switched to a night light mode. With included remote control or, for luminaires without remote control, via wall switch (ambient light).

Leuchten können auf einen Nacht-Licht-Modus umgeschaltet werden. Mit inkludierter Fernbedienung oder bei Leuchten ohne Fernbedienung per Wandschalter (Ambient light).

Les luminaires peuvent être commutés en mode veilleuse. Avec télécommande incluse ou, pour les luminaires sans télécommande, via interrupteur mural (lumière ambiante).



TIMER FUNCTION

e.g./z.B./par ex.
off after 30 sec.

The luminaire switches itself off after a preset time.

Die Leuchte schaltet sich nach einer voreingestellten Zeit selbst aus.

La lumière s'éteint d'elle-même après une durée prédéfinie.





900952



REMOTE+

Our new 2.4 GHz REMOTE+ makes it easier than ever to control your lights. With its user-friendly design and simple control, you can easily adjust your luminaire to create the perfect ambiance for any occasion:

- › Stepless Dimming
- › Quick Pairing
- › Timer Function
- › Stepless Tunable White
- › Memory Effect
- › Control up to 10 REMOTE+ luminaires

Unsere neue 2,4-GHz REMOTE+ macht die Steuerung Ihrer Leuchten so einfach wie nie zuvor. Mit ihrem benutzerfreundlichen Design und der einfachen Steuerung können Sie Ihre Leuchte ganz einfach einstellen, um das perfekte Ambiente für jede Gelegenheit zu schaffen:

- › Stufenloses Dimmen
- › Schnelle Kopplung
- › Timer-Funktion
- › Stufenlos einstellbares Weiß
- › Memory-Effekt
- › Steuerung von bis zu 10 REMOTE+-Leuchten

Notre nouvelle REMOTE+ 2,4 GHz facilite plus que jamais le contrôle de vos lumières. Grâce à sa conception conviviale et à sa commande simple, vous pouvez facilement régler votre luminaire pour créer l'ambiance parfaite en toute occasion:

- › Gradation progressive
- › appairage rapide
- › Fonction de minuterie
- › Blanc réglable en continu
- › Effet de mémoire
- › Contrôle jusqu'à 10 luminaires REMOTE

900952 AMANDOLO

ceiling light; aluminium, steel, white / plastic, white
 Deckenleuchte; Alu, Stahl, weiss / Kunststoff, weiss
 plafonnier; aluminium, acier, blanc / plastique, blanc

L 775, B 200, H 75



23,5W



2850lm



CR2032



9 008606 275045





900953



900955

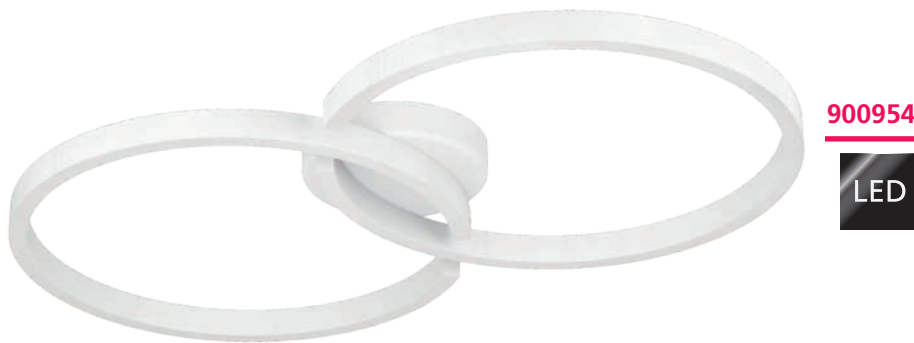

900954



900953 AMANDOLO

ceiling light; aluminium, steel, black / plastic, white
Deckenleuchte; Alu, Stahl, schwarz / Kunststoff, weiss
plafonnier; aluminium, acier, noir / plastique, blanc

L 775, B 200, H 75



23,5W 2850lm CR2032

900954 AMANDOLO

ceiling light; aluminium, steel, white / plastic, white
Deckenleuchte; Alu, Stahl, weiss / Kunststoff, weiss
plafonnier; aluminium, acier, blanc / plastique, blanc

L 675, B 380, H 65



19,5W 2400lm CR2032

900955 AMANDOLO

ceiling light; aluminium, steel, black / plastic, white
Deckenleuchte; Alu, Stahl, schwarz / Kunststoff, weiss
plafonnier; aluminium, acier, noir / plastique, blanc

L 675, B 380, H 65



19,5W 2400lm CR2032



9 008606 275052



9 008606 275069



9 008606 275076





900471

LED



900596

LED



incl./inkl./inclus

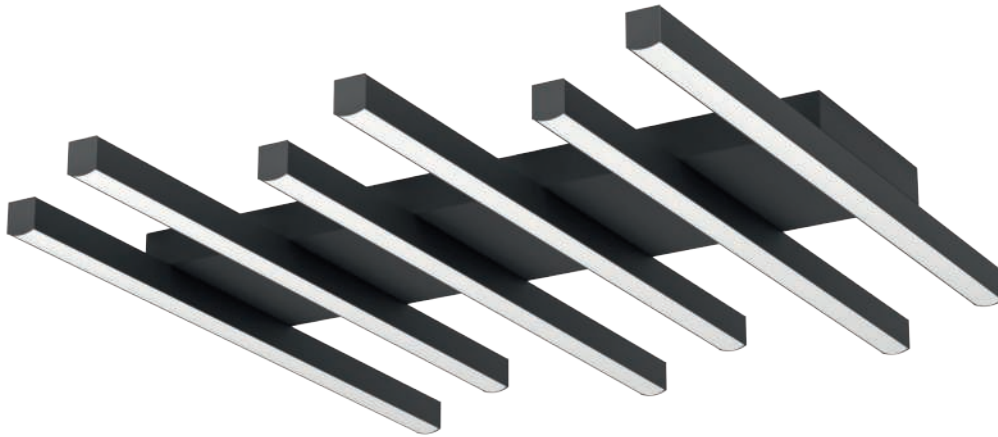

900597

LED



incl./inkl./inclus

900471 RUOTALE

ceiling light; aluminium, steel, black / plastic, white
Deckenleuchte; Alu, Stahl, schwarz / Kunststoff, weiss
plafonnier; aluminium, acier, noir / plastique, blanc

H 55, Ø 450



36W



4400lm



900596 ULISANO

ceiling light; aluminium, steel, black / plastic, white
Deckenleuchte; Alu, Stahl, schwarz / Kunststoff, weiss
plafonnier; aluminium, acier, noir / plastique, blanc

L 420, B 420, H 55



21W



3000lm



900597 PADULARI

ceiling light; aluminium, steel, black / plastic, white
Deckenleuchte; Alu, Stahl, schwarz / Kunststoff, weiss
plafonnier; aluminium, acier, noir / plastique, blanc

L 535, B 470, H 50



25,6W



3800lm



Remote



9 008606 244096

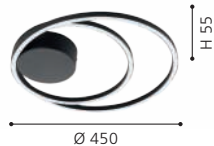

9 008606 244959



9 008606 244966





99395

LED



900419

LED



900419 ROLIMARE

ceiling light; aluminium, satin nickel / plastic, white
Deckenleuchte; Alu, nickel-matt / Kunststoff, weiss
plafonnier; aluminium, nickel mat / plastique, blanc

L 420, B 400, H 130



35W 5500lm

99395 ROLIMARE

ceiling light; aluminium, black / plastic, white
Deckenleuchte; Alu, schwarz / Kunststoff, weiss
plafonnier; aluminium, noir / plastique, blanc

L 420, B 400, H 130



35W 5500lm



9 008606 240999



9 002759 993955





99788

LED

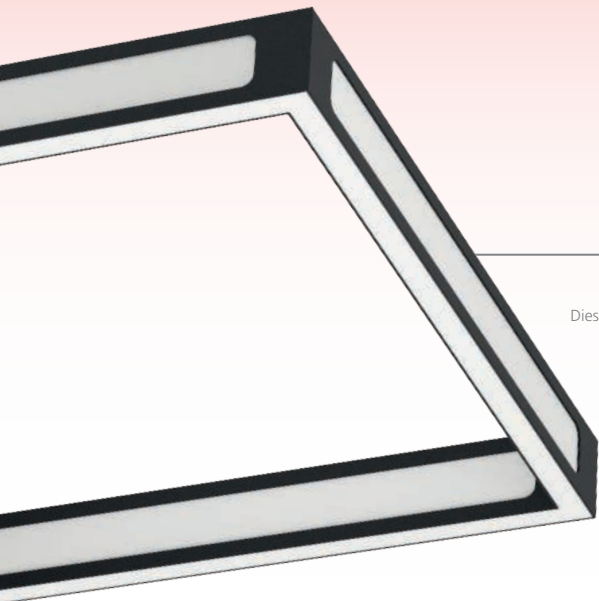

ALTAFLOR

These luminaires have an additional glow on the inside.
Diese Leuchten haben einen zusätzlichen Lichtschein nach Innen.
Ces luminaires ont une lueur supplémentaire à l'intérieur.

99788 ALTAFLOR

ceiling light; steel, black / plastic, white
Deckenleuchte; Stahl, schwarz / Kunststoff, weiss
plafonnier; acier, noir / plastique, blanc

L 650, B 300, H 70

LED

warm
WHITE



8x 2,8W 3040lm



9 002759 997885

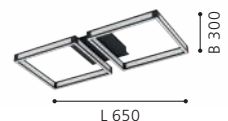

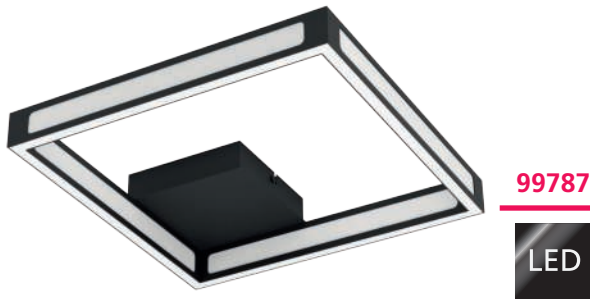

99787



99789

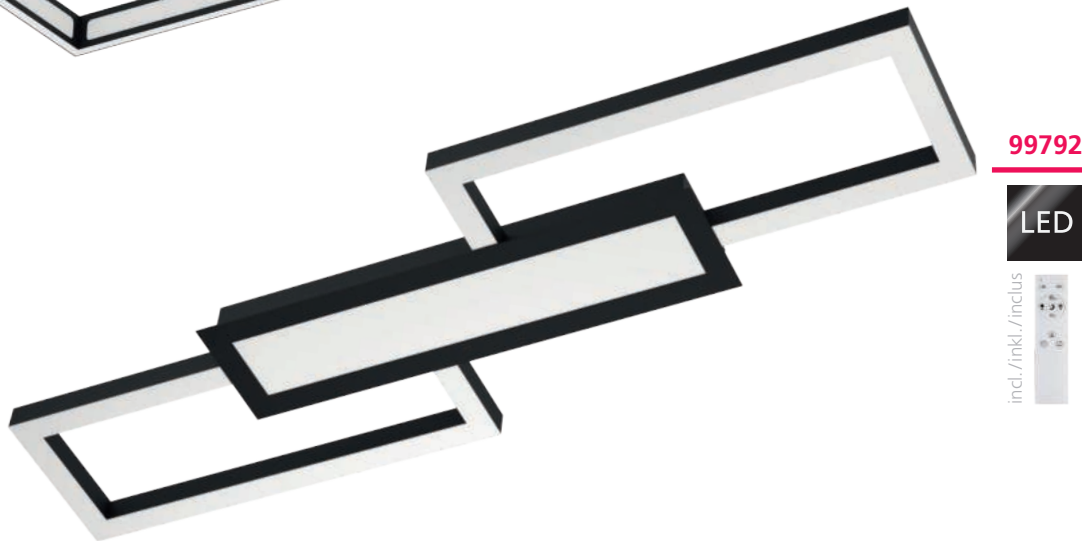

99792



incl./mkl./inclus

99787 ALTAFLOR

ceiling light; steel, black / plastic, white
 Deckenleuchte; Stahl, schwarz / Kunststoff, weiss
 plafonnier; acier, noir / plastique, blanc

L 315, B 315, H 70



4x 2,8W 1520lm

99789 ALTAFLOR

ceiling light; steel, black / plastic, white
 Deckenleuchte; Stahl, schwarz / Kunststoff, weiss
 plafonnier; acier, noir / plastique, blanc

L 1000, B 315, H 70



12x 2,8W 4560lm

99792 MONIROTE

ceiling light; steel, aluminium, black / plastic, white
 Deckenleuchte; Stahl, Alu, schwarz / Kunststoff, weiss
 plafonnier; acier, aluminium, noir / plastique, blanc

L 780, B 260, H 45



37W 4450lm Remote



9 002759 997878

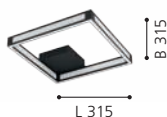

9 002759 997892

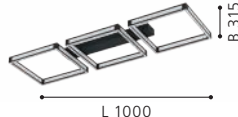

9 002759 997922

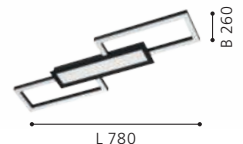

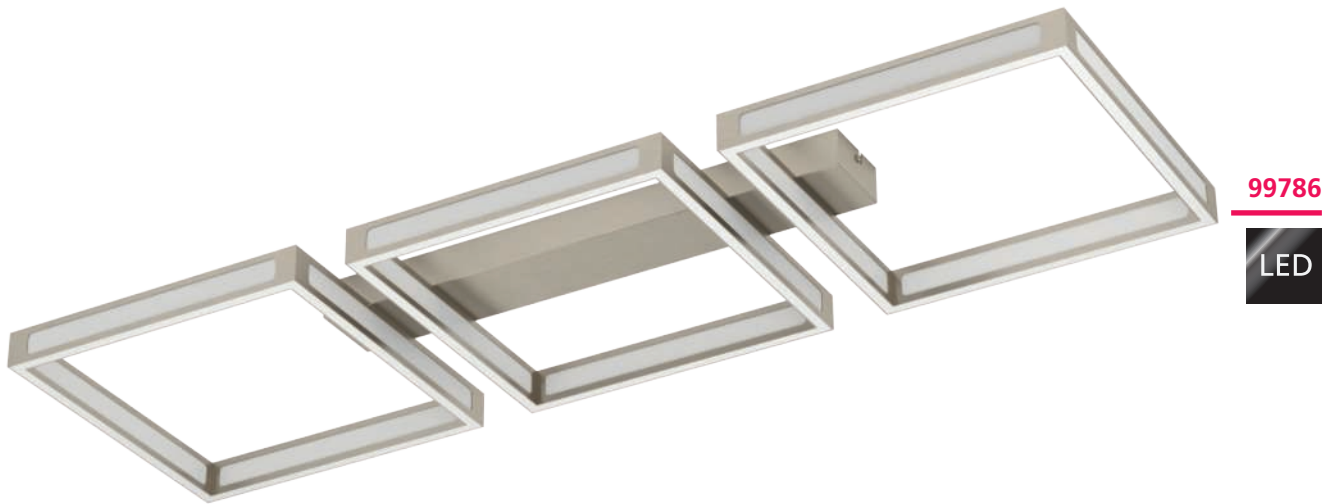
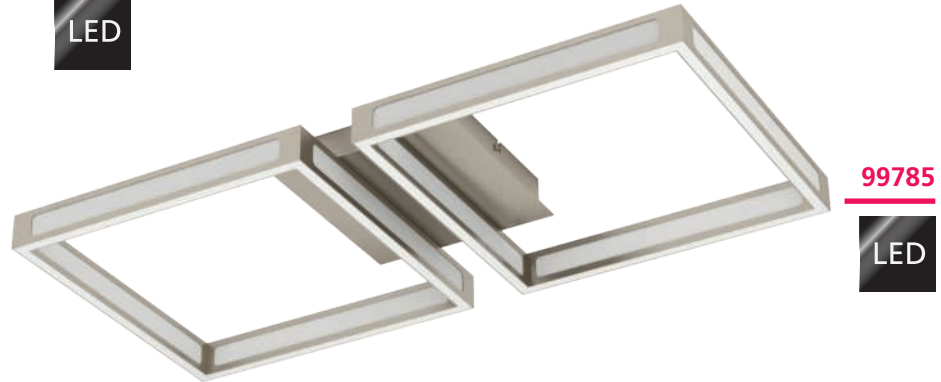

99784 ALTAFLOR

ceiling light; steel, satin nickel / plastic, white
Deckenleuchte; Stahl, nickel-matt / Kunststoff, weiss
plafonnier; acier, nickel mat / plastique, blanc

L 315, B 315, H 70



4x 2,8W 1520lm

99785 ALTAFLOR

ceiling light; steel, satin nickel / plastic, white
Deckenleuchte; Stahl, nickel-matt / Kunststoff, weiss
plafonnier; acier, nickel mat / plastique, blanc

L 650, B 300, H 70



8x 2,8W 3040lm

99786 ALTAFLOR

ceiling light; steel, satin nickel / plastic, white
Deckenleuchte; Stahl, nickel-matt / Kunststoff, weiss
plafonnier; acier, nickel mat / plastique, blanc

L 1000, B 315, H 70



12x 2,8W 4560lm

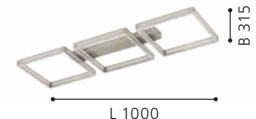
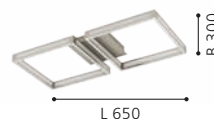
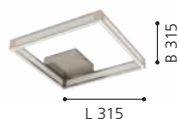



99791

LED

incl./inkl./inclus



99791 MONIROTE

ceiling light; steel, aluminium, satin nickel / plastic, white
Deckenleuchte; Stahl, Alu, nickel-matt / Kunststoff, weiss
plafonnier; acier, aluminium, nickel mat / plastique, blanc

L 780, B 260, H 45



37W



4450lm



Remote



9 002759 997915

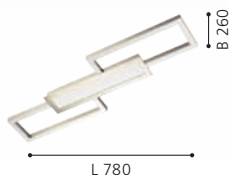

ALTAFLOR

These luminaires have an additional glow on the inside.

Diese Leuchten haben einen zusätzlichen Lichtschein nach Innen.

Ces luminaires ont une lueur supplémentaire à l'intérieur.



900421

LED

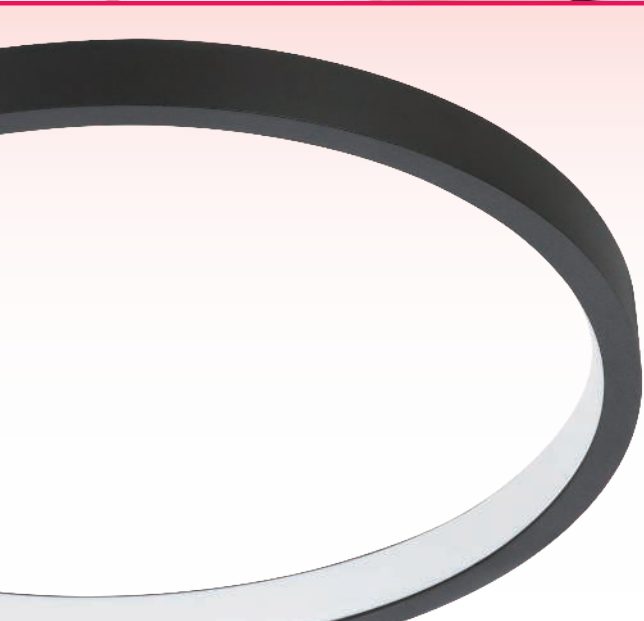

DESIGN
HIGHLIGHT
DETAIL

900421 GAFARES

ceiling light; aluminium, steel, black, white / plastic, white
Deckenleuchte; Alu, Stahl, schwarz, weiss / Kunststoff, weiss
plafonnier; aluminium, acier, noir, blanc / plastique, blanc

L 405, B 290, H 55

LED
15W

tunable
WHITE
2100lm



CONTROL
UNIT
Remote





900422

LED

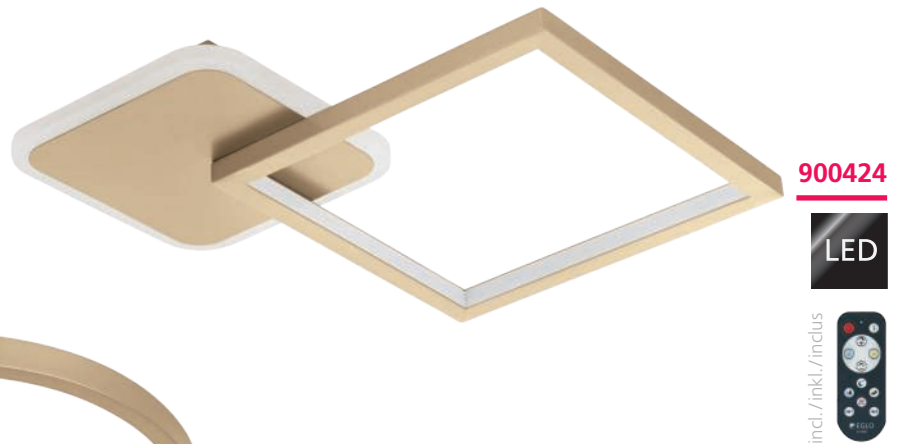

900424

LED



900423

LED



900422 GAFARES

ceiling light; aluminium, steel, black, white / plastic, white
Deckenleuchte; Alu, Stahl, schwarz, weiss / Kunststoff, weiss
plafonnier; aluminium, acier, noir, blanc / plastique, blanc

L 330, B 330, H 50



15W 2100lm

Remote

900423 GAFARES

ceiling light; aluminium, steel, gold, white / plastic, white
Deckenleuchte; Alu, Stahl, gold, weiss / Kunststoff, weiss
plafonnier; aluminium, acier, or, blanc / plastique, blanc

L 405, B 290, H 55



15W 2100lm

Remote

900424 GAFARES

ceiling light; aluminium, steel, gold, white / plastic, white
Deckenleuchte; Alu, Stahl, gold, weiss / Kunststoff, weiss
plafonnier; aluminium, acier, or, blanc / plastique, blanc

L 330, B 330, H 50



15W 2100lm

Remote



9 008606 241026

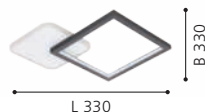

9 008606 241019



9 008606 241033

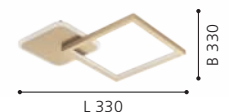



900329

LED



900328

LED

900329 ZAMPOTE

ceiling light; aluminium, steel, white, black / plastic, white
Deckenleuchte; Alu, Stahl, weiss, schwarz / Kunststoff, weiss
plafonnier; aluminium, acier, blanc, noir / plastique, blanc

L 380, B 380, H 50



25W 3300lm

900328 ZAMPOTE

ceiling light; aluminium, steel, white, black / plastic, white
Deckenleuchte; Alu, Stahl, weiss, schwarz / Kunststoff, weiss
plafonnier; aluminium, acier, blanc, noir / plastique, blanc

H 50, Ø 420



25W 3400lm

99817 IPOLITTO

ceiling light; aluminium, steel, black / plastic, white
Deckenleuchte; Alu, Stahl, schwarz / Kunststoff, weiss
plafonnier; aluminium, acier, noir / plastique, blanc

L 995, B 165, H 245



4x 7,5W 3600lm



9 008606 238101

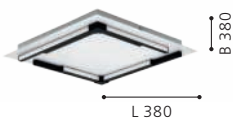

9 008606 238095



9 002759 998172

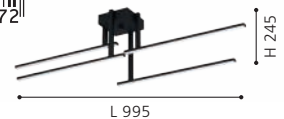



99817

LED



900603



incl./inkl./inclus



900604



incl./inkl./inclus



99793



900603 TIRRENARA

ceiling light; steel, wood, black, brown / plastic, white
Deckenleuchte; Stahl, Holz, schwarz, braun / Kunststoff, weiss
plafonnier; acier, bois, noir, marron / plastique, blanc

L 370, B 370, H 55



4x 5,4W 2600lm

Remote

900604 TIRRENARA

ceiling light; steel, wood, black, brown / plastic, white
Deckenleuchte; Stahl, Holz, schwarz, braun / Kunststoff, weiss
plafonnier; acier, bois, noir, marron / plastique, blanc

L 780, B 305, H 55



2x 9,2W 3960lm 1x 13,7W Remote

99793 MARINELLO 1

ceiling light; aluminium, steel, wood, black, brown / plastic, white
Deckenleuchte; Alu, Stahl, Holz, schwarz, braun / Kunststoff, weiss
plafonnier; aluminium, acier, bois, noir, marron / plastique, blanc

L 500, B 500, H 90



4x 5,3W 2800lm



9 008606 245017

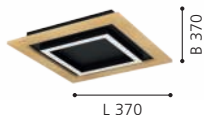

9 008606 245024

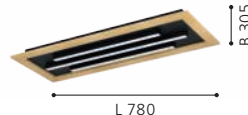

9 002759 997939

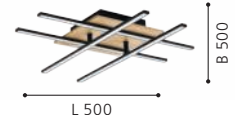



99659

LED

incl./inkl./inclus



99659 MARINELLO

ceiling light; aluminium, steel, wood, black, brown / plastic, white

Deckenleuchte; Alu, Stahl, Holz, schwarz, braun / Kunststoff, weiss

plafonnier; aluminium, acier, bois, noir, marron / plastique, blanc

L 485, B 485, H 55

LED

2x 17W

tunable
WHITE

4400lm

LED

4,2W

tunable
WHITE

590lm



Remote



9 002759 996598

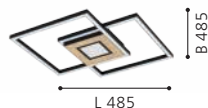



98861



MIRLAS



98862



98861 MIRLAS

ceiling light; wood, steel, brown / plastic, white
Deckenleuchte; Holz, Stahl, braun / Kunststoff, weiss
plafonnier; bois, acier, marron / plastique, blanc

L 360, B 210, H 90



E27



2x 9W

98862 MIRLAS

ceiling light; wood, steel, brown / plastic, white
Deckenleuchte; Holz, Stahl, braun / Kunststoff, weiss
plafonnier; bois, acier, marron / plastique, blanc

L 690, B 270, H 90



E27



4x 9W

98863 MIRLAS

ceiling light; wood, steel, brown / plastic, white
Deckenleuchte; Holz, Stahl, braun / Kunststoff, weiss
plafonnier; bois, acier, marron / plastique, blanc

L 540, B 520, H 90



E27



6x 9W



9 002759 988616



9 002759 988623

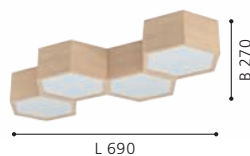

9 002759 988630

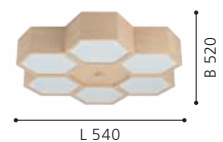



98863



99656

LED



TAMURIA

This luminaires have rotatable panels in wood look and black.
Diese Artikel verfügen über Platten in Holzoptik und schwarz zum Wechseln.
Ces luminaires a des panneaux en bois optique et noir à changer.

99656 TAMURIA

ceiling light; steel, wood, black, brown / plastic, white
Deckenleuchte; Stahl, Holz, schwarz, braun / Kunststoff, weiss
plafonnier; acier, bois, noir, marron / plastique, blanc

L 435, B 435, H 70



21W 2700lm

99655 TAMURIA

ceiling light; steel, wood, black, brown / plastic, white
Deckenleuchte; Stahl, Holz, schwarz, braun / Kunststoff, weiss
plafonnier; acier, bois, noir, marron / plastique, blanc

L 285, B 285, H 60



10,8W 1300lm





99655

LED



900573



900571



900572



900573 BORDONARA

ceiling light; aluminium, steel, black, white / plastic, white
Deckenleuchte; Alu, Stahl, schwarz, weiss / Kunststoff, weiss
plafonnier; aluminium, acier, noir, blanc / plastique, blanc

L 1195, B 295



35W



5400lm



Remote



900571 BORDONARA

ceiling light; aluminium, steel, black, white / plastic, white
Deckenleuchte; Alu, Stahl, schwarz, weiss / Kunststoff, weiss
plafonnier; aluminium, acier, noir, blanc / plastique, blanc

L 450, B 450



21,5W



2800lm



Remote



900572 BORDONARA

ceiling light; aluminium, steel, black, white / plastic, white
Deckenleuchte; Alu, Stahl, schwarz, weiss / Kunststoff, weiss
plafonnier; aluminium, acier, noir, blanc / plastique, blanc

L 595, B 595



36W



4900lm



Remote



9 008606 244744



9 008606 244720



9 008606 244737

